



600V Super-junction Power MOSFET

DESCRIPTION

600V Super-junction Power MOSFET

Super-junction power MOSFET is a revolutionary technology for high voltage power MOSFETs, designed according to the SJ principle. The Multi-EPI SJ MOSFET provide an extremely low switching, commutation and conduction losses device with highest robustness make especially resonant switching applications more reliable, more efficient, lighter and cooler, designed by Wuxi Unigroup Microelectronics Company.

FEATURES

- Very low FOM $R_{DS(on)} \times Q_g$
- 100% avalanche tested
- Easy to use/drive
- RoHS compliant

APPLICATIONS

- Switch Mode Power Supply (SMPS)
- Uninterruptible Power Supply (UPS)
- Power Factor Correction (PFC)
- Charger

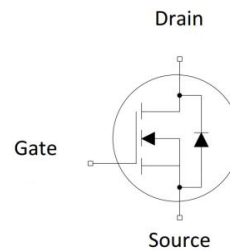
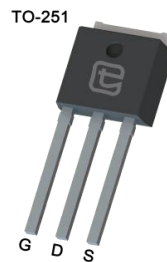
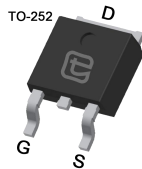

Device Marking and Package Information

Device	Package	Marking
TPA60R530M	TO-220F	60R530M
TPD60R530M	TO-252	60R530M
TPU60R530M	TO-251	60R530M

Key Performance Parameters

Parameter	Value	Unit
$V_{DS} @ T_{j,max}$	600	V
$R_{DS(on),max}$	0.53	Ω
I_D	7	A
$Q_{g,typ}$	13.8	nC
I_{DM}	21	A



Absolute Maximum Ratings $T_C = 25^\circ\text{C}$, unless otherwise noted				
Parameter	Symbol	Value		Unit
		TO-220F	TO-252/TO-251	
Drain-Source Voltage ($V_{GS} = 0\text{V}$)	V_{DSS}	600		V
Continuous Drain Current	I_D	$T_C = 25^\circ\text{C}$	7	A
		$T_C = 100^\circ\text{C}$	4.2	
Pulsed Drain Current (note1)	I_{DM}	21		A
Gate-Source Voltage	V_{GSS}	± 30		V
Single Pulse Avalanche Energy (note2)	E_{AS}	142		mJ
Repetitive Avalanche Energy (note2)	E_{AR}	0.21		mJ
Avalanche Current	I_{AR}	1.3		A
MOSFET dv/dt ruggedness, $V_{DS} = 0 \dots 480\text{V}$	dv/dt	50		V/ns
Power Dissipation	P_D	28	63	W
Continuous Body Diode Current	I_S	6		A
Pulsed Diode Forward Current (note1)	I_{SM}	21		
Reverse diode dv/dt (note3)	dv/dt	15		V/ns
Maximum diode commutation speed (note3)	di_f/dt	500		A/us
Operating Junction and Storage Temperature Range	T_J, T_{stg}	-55~+150		$^\circ\text{C}$

Thermal Resistance				
Parameter	Symbol	Value		Unit
		TO-220F	TO-252/TO-251	
Thermal Resistance, Junction-to-Case	R_{thJC}	4.5	2.0	$^\circ\text{C/W}$
Thermal Resistance, Junction-to-Ambient	R_{thJA}	80	62	



Specifications $T_J = 25^{\circ}\text{C}$, unless otherwise noted						
Parameter	Symbol	Test Conditions	Value			Unit
			Min.	Typ.	Max.	
Static						
Drain-Source Breakdown Voltage	$V_{(BR)DSS}$	$V_{GS} = 0V, I_D = 250\mu A$	600	--	--	V
Zero Gate Voltage Drain Current	I_{DSS}	$V_{DS} = 600V, V_{GS} = 0V, T_J = 25^{\circ}\text{C}$	--	--	1	μA
		$V_{DS} = 600V, V_{GS} = 0V, T_J = 150^{\circ}\text{C}$	--	--	100	
Gate-Source Leakage	I_{GSS}	$V_{GS} = \pm 30V$	--	--	± 100	nA
Gate-Source Threshold Voltage	$V_{GS(th)}$	$V_{DS} = V_{GS}, I_D = 250\mu A$	2.5	--	4.0	V
Drain-Source On-Resistance	$R_{DS(on)}$	$V_{GS} = 10V, I_D = 3.5A$	--	0.46	0.53	Ω
Gate resistance	R_G	$f = 1.0\text{MHz}$ open drain	--	7	--	Ω
Dynamic						
Input Capacitance	C_{iss}	$V_{GS} = 0V,$ $V_{DS} = 100V,$ $f = 1.0\text{MHz}$	--	526	--	μF
Output Capacitance	C_{oss}		--	27	--	
Reverse Transfer Capacitance	C_{rss}		--	1.6	--	
Total Gate Charge	Q_g	$V_{DD} = 480V, I_D = 7A,$ $V_{GS} = 10V$	--	13.8	--	nC
Gate-Source Charge	Q_{gs}		--	2.8	--	
Gate-Drain Charge	Q_{gd}		--	5.6	--	
Turn-on Delay Time	$t_{d(on)}$	$V_{DD} = 400V, I_D = 7A,$ $R_G = 25\Omega$	--	53	--	ns
Turn-on Rise Time	t_r		--	60	--	
Turn-off Delay Time	$t_{d(off)}$		--	102	--	
Turn-off Fall Time	t_f		--	52	--	
Drain-Source Body Diode Characteristics						
Body Diode Voltage	V_{SD}	$T_J = 25^{\circ}\text{C}, I_{SD} = 3.5A, V_{GS} = 0V$	--	0.9	1.2	V
Reverse Recovery Time	t_{rr}	$V_R = 400V, I_F = 7A,$ $di_F/dt = 100A/\mu s$	--	321	--	ns
Reverse Recovery Charge	Q_{rr}		--	3.4	--	μC
Peak Reverse Recovery Current	I_{rrm}		--	21	--	A

Notes

1. Repetitive Rating: Pulse width limited by maximum junction temperature
2. $I_{AS} = 1.3A, V_{DD} = 50V, R_G = 25\Omega$, Starting $T_J = 25^{\circ}\text{C}$
3. Identical low side and high side switch with identical R_G



Typical Characteristics $T_J = 25^\circ\text{C}$, unless otherwise noted

Figure 1. Output Characteristics

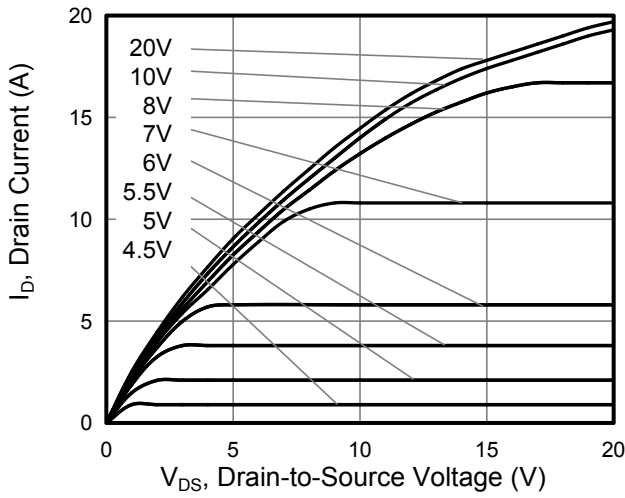

Figure 2. Transfer Characteristics

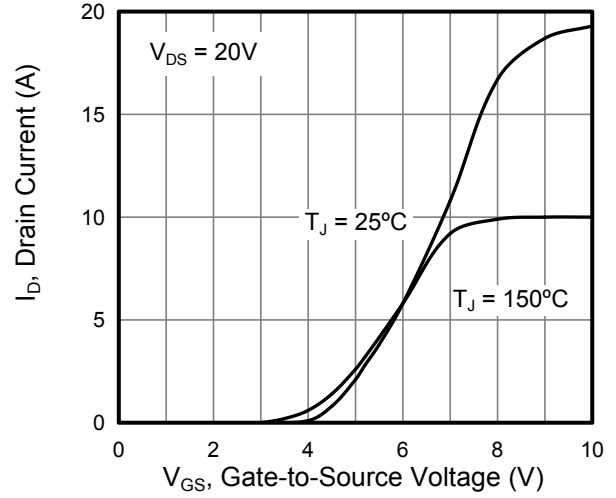

Figure 3. On-Resistance vs. Drain Current

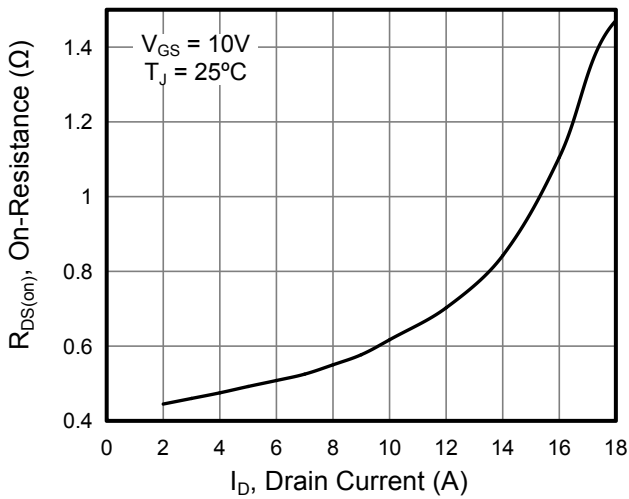

Figure 4. Capacitance

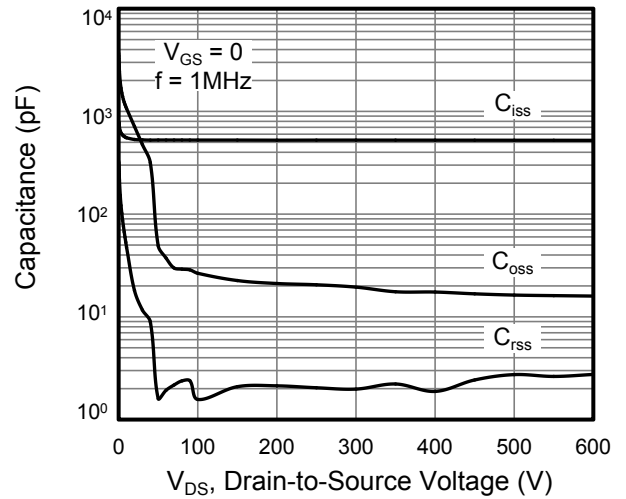

Figure 5. Gate Charge

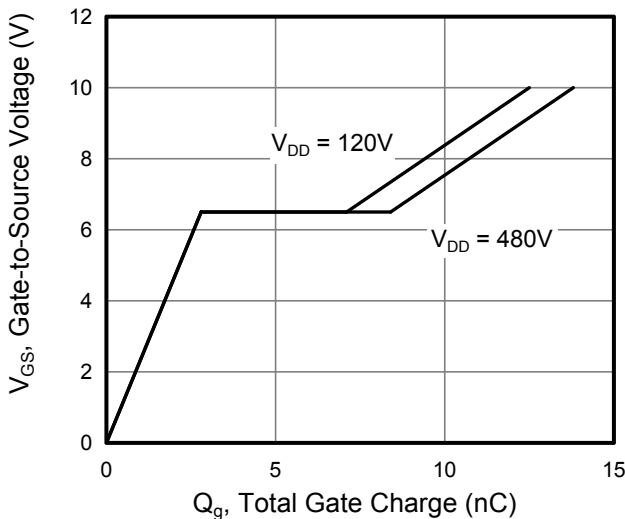
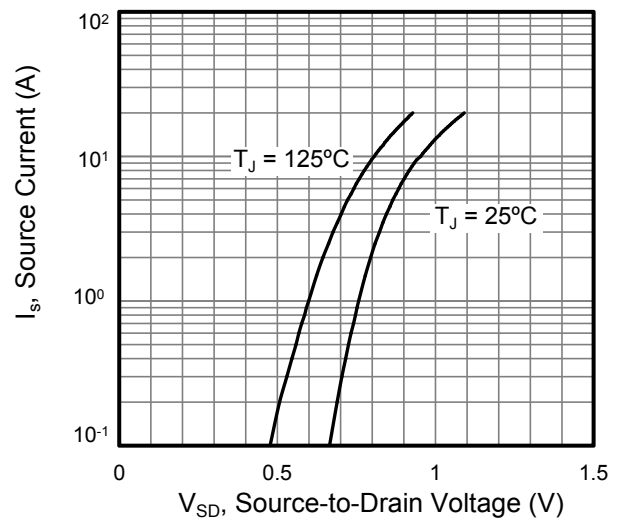

Figure 6. Body Diode Forward Voltage





Typical Characteristics $T_J = 25^\circ\text{C}$, unless otherwise noted

Figure 7. On-Resistance vs. Junction Temperature

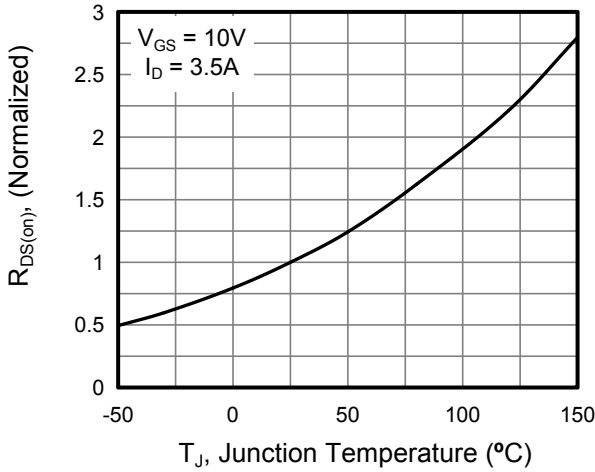

Figure 8. Breakdown voltage vs. Junction Temperature

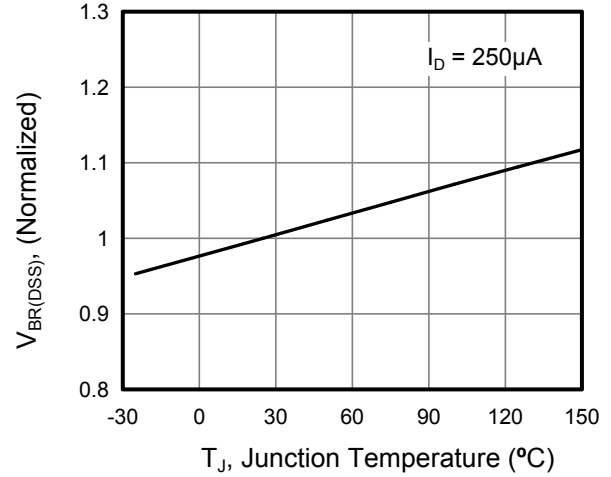

Figure 9. Transient Thermal Impedance TO-220F

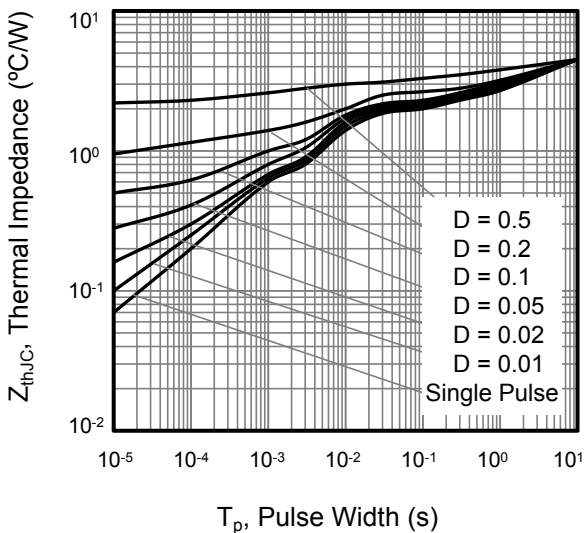

Figure 10. Safe operation area for TO-220F

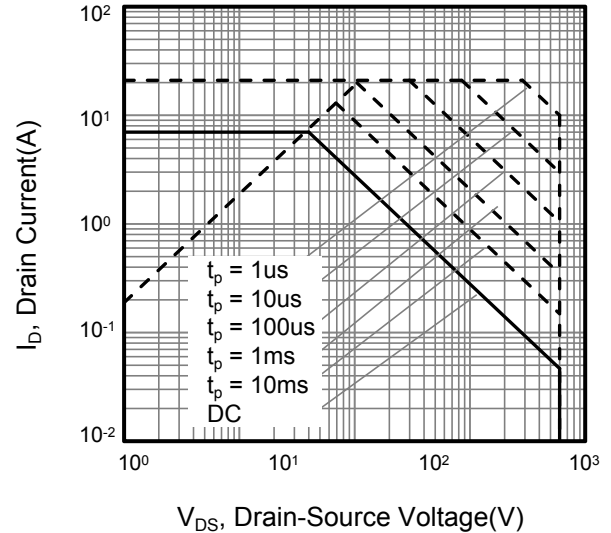

Figure 11. Transient Thermal Impedance TO-252/TO-251

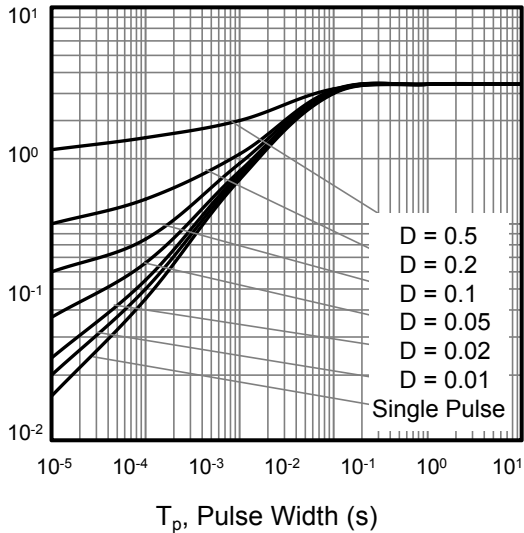

Figure 12. Safe operation area for TO-252/TO-251

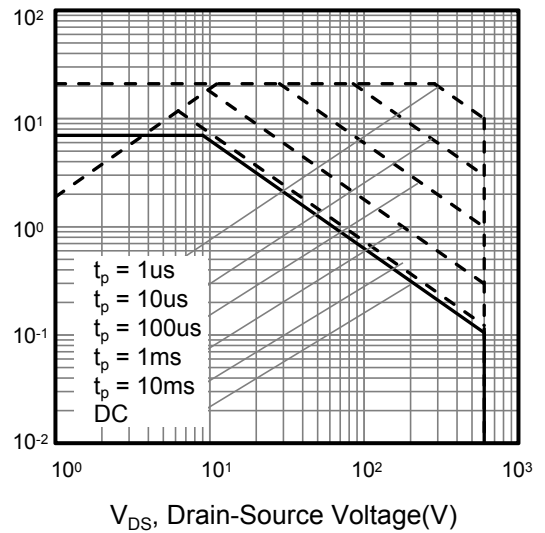



Figure A: Gate Charge Test Circuit and Waveform

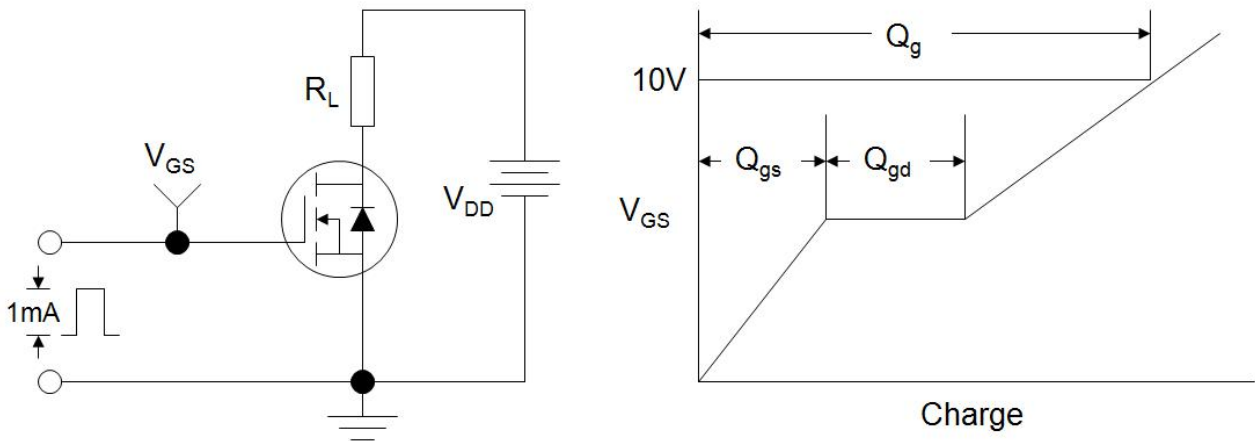

Figure B: Resistive Switching Test Circuit and Waveform

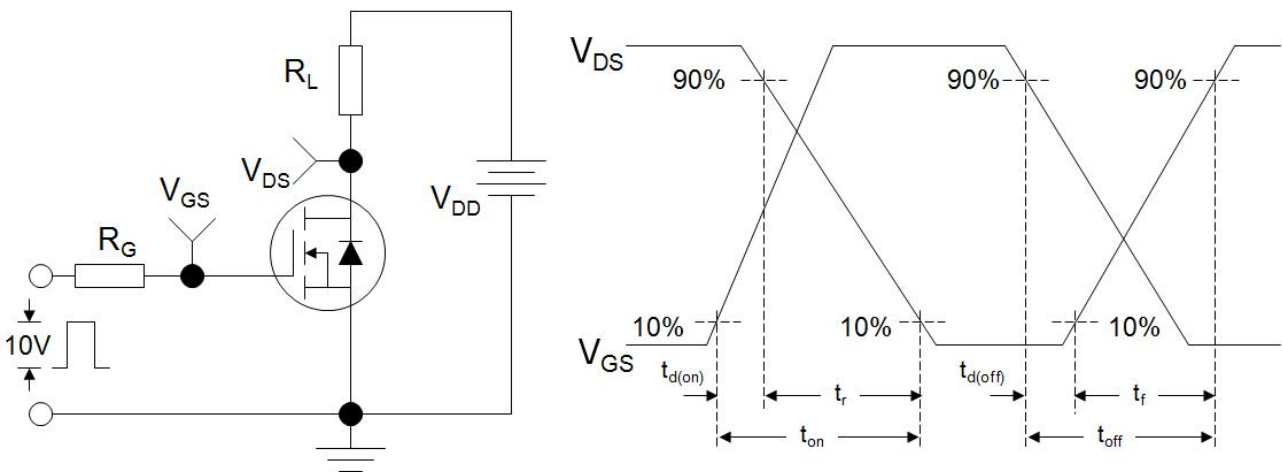
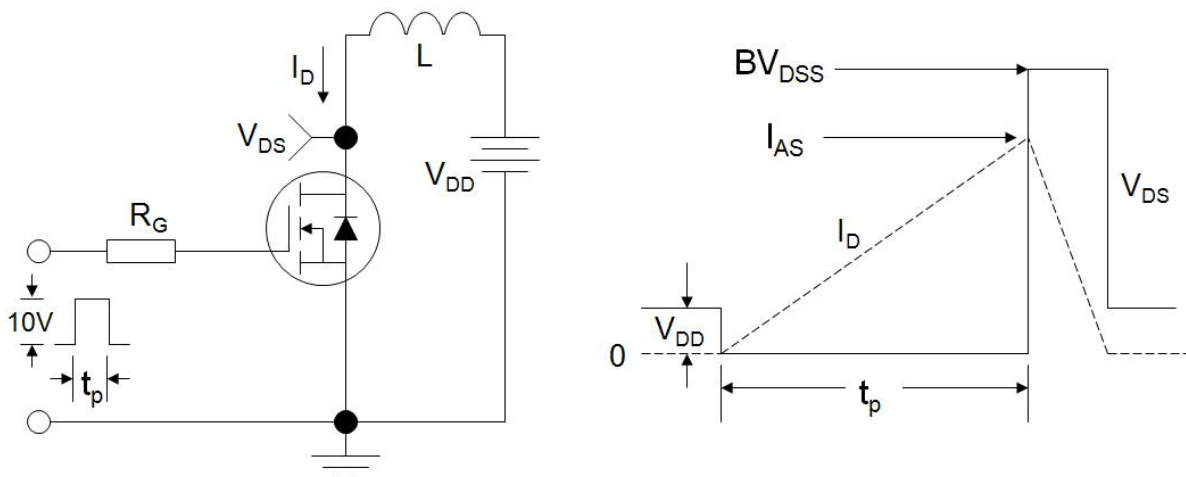
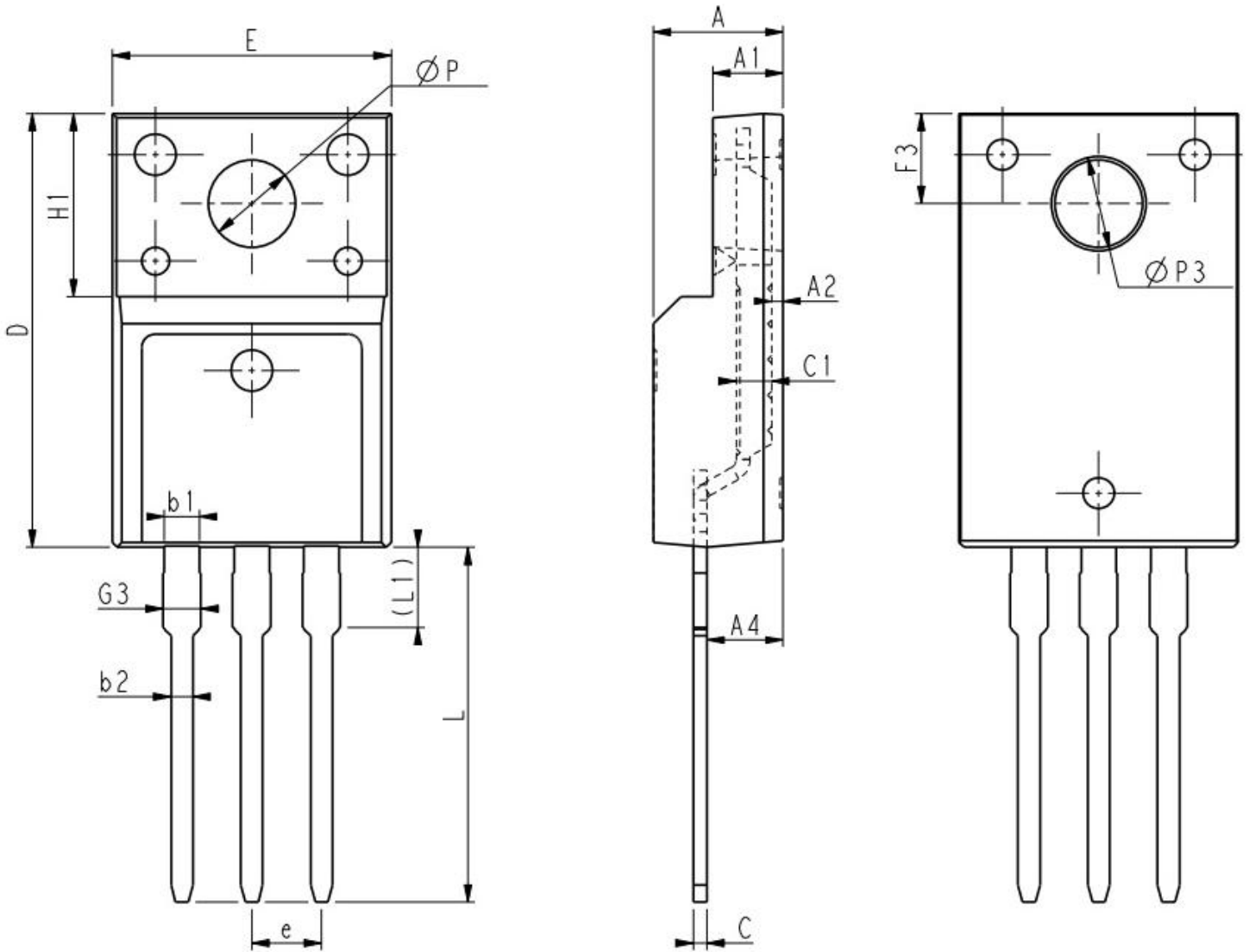

Figure C: Unclamped Inductive Switching Test Circuit and Waveform





TO-220F



Unit:mm			
Symbol	Min.	Nom	Max.
E	9.96	10.16	10.36
A	4.50	4.70	4.90
A1	2.34	2.54	2.74
A2	0.30	0.45	0.60
A4	2.56	2.76	2.96
c	0.40	0.50	0.65
c1	1.20	1.30	1.35
D	15.57	15.87	16.17
H1	6.70REF		

Unit:mm			
Symbol	Min.	Nom	Max.
e	2.54BSC		
L	12.68	12.98	13.28
L1	2.93	3.03	3.13
ΦP	3.03	3.18	3.38
$\Phi P3$	3.15	3.45	3.65
F3	3.15	3.30	3.45
G3	1.25	1.35	1.55
b1	1.18	1.28	1.43
b2	0.70	0.80	0.95



TO-252

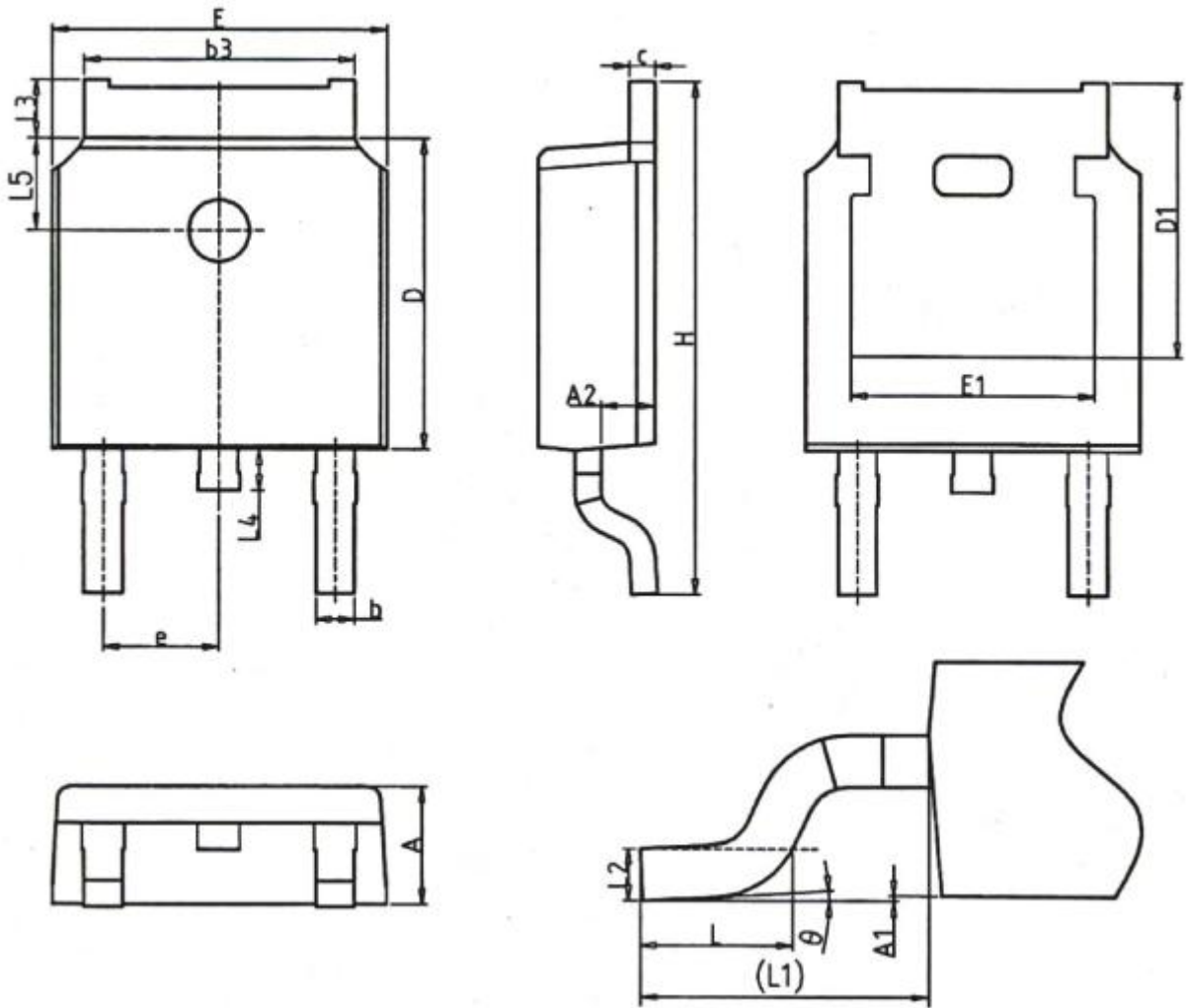

Unit:mm			
Symbol	Min.	Nom	Max.
A	2.20	2.30	2.40
A1	0.00	-	0.20
A2	0.97	1.07	1.17
b	0.68	0.78	0.90
b3	5.20	5.33	5.50
c	0.43	0.53	0.63
D	5.98	6.10	6.22
D1	5.30 REF		
E	6.40	6.60	6.80
E1	4.63	-	-

Unit:mm			
Symbol	Min.	Nom	Max.
e	2.286 BSC		
H	9.40	10.10	10.50
L	1.38	1.50	1.75
L1	2.90 REF		
L2	0.51 BSC		
L3	0.88	-	1.28
L4	-	-	1.00
L5	1.65	1.80	1.95
θ	0°	-	8°



TO-251

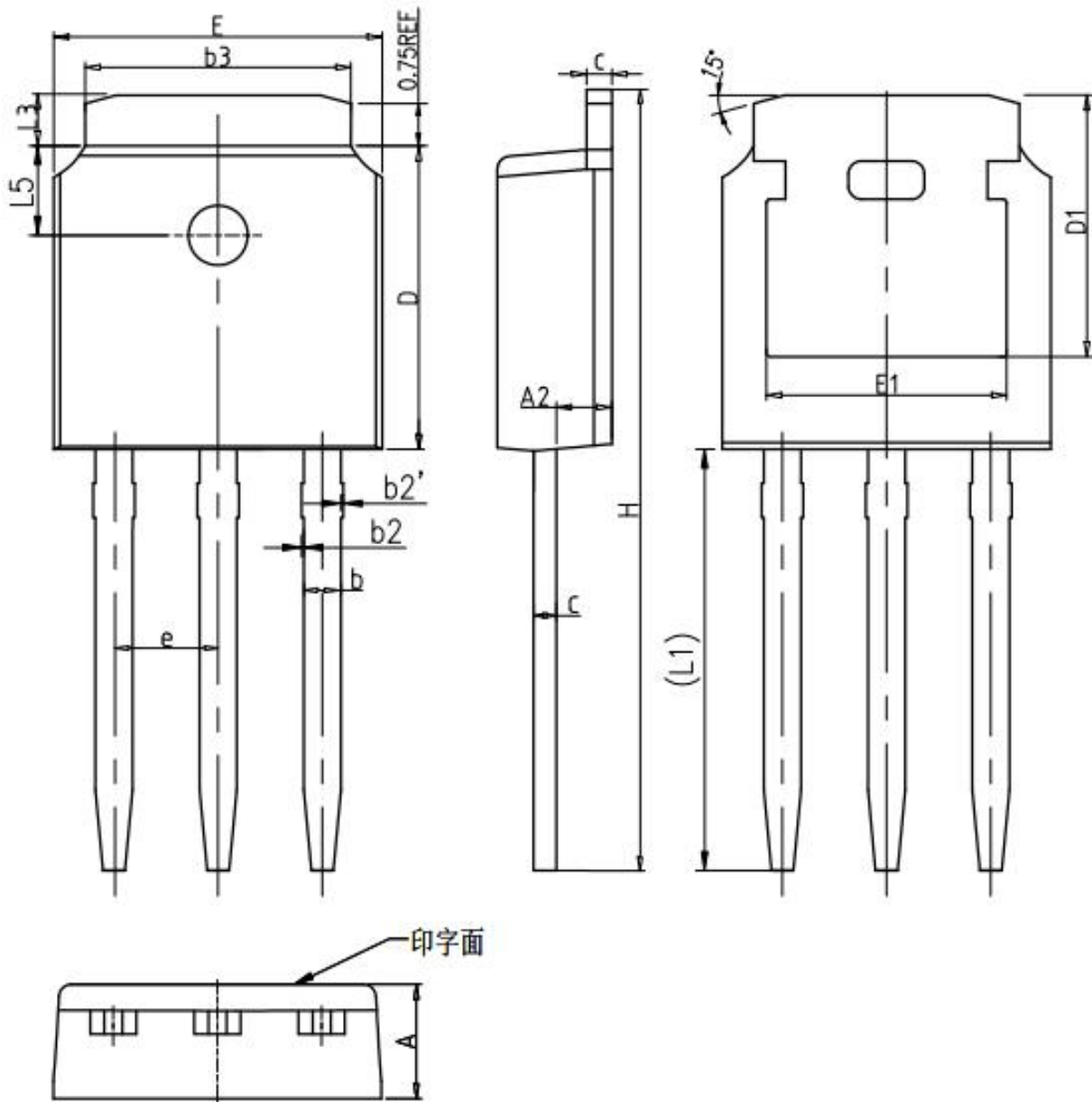

Unit:mm			
Symbol	Min.	Nom	Max.
A	2.20	2.30	2.38
A2	0.97	1.07	1.17
b	0.68	0.78	0.90
b2	0.00	0.04	0.10
b2'	0.00	0.04	0.10
b3	5.20	5.33	5.46
c	0.43	0.53	0.61
D	5.98	6.10	6.22

Unit:mm			
Symbol	Min.	Nom	Max.
D1	5.30 REF		
E	6.40	6.60	6.73
E1	4.63	-	-
e	2.286 BSC		
H	16.22	16.52	16.82
L1	9.15	9.40	9.65
L3	0.88	1.02	1.28
L5	1.65	1.80	1.95



Disclaimer

All product specifications and data are subject to change without notice.

For documents and material available from this datasheet, Wuxi Unigroup does not warrant or assume any legal liability or responsibility for the accuracy, completeness of any product or technology disclosed hereunder.

No license, express or implied, by estoppels or otherwise, to any intellectual property rights is granted by this document or by any conduct of Wuxi Unigroup.

The products shown herein are not designed for use in medical, life-saving, or life-sustaining applications. Customers using or selling Wuxi Unigroup products not expressly indicated for use in such applications do so entirely at their own risk and agree to fully indemnify Wuxi Unigroup for any damages arising or resulting from such use or sale.

Wuxi Unigroup disclaims any and all liability arising out of the use or application of any product described herein or of any information provided herein to the maximum extent permitted by law. The product specifications do not expand or otherwise modify Wuxi Unigroup's terms and conditions of purchase, including but not limited to the warranty expressed therein, which apply to these products.

Wuxi Unigroup Microelectronics CO., LTD. strives to supply high-quality high-reliability products. However, any and all semiconductor products fail with some probability. It is possible that these probabilistic failures could give rise to accidents or events that could endanger human lives that could give rise to smoke or fire, or that could cause damage to other property. When designing equipment, adopt safety measures so that these kinds of accidents or events cannot occur. Such measures include but are not limited to protective circuits and error prevention circuits for safe design, redundant design, and structural design.

In the event that any or all Wuxi Unigroup products (including technical data, services) described or contained herein are controlled under any of applicable local export control laws and regulations, such products must not be exported without obtaining the export license from the authorities concerned in accordance with the above law.

Information (including circuit diagrams and circuit parameters) herein is for example only. It is not guaranteed for volume production. Wuxi Unigroup believes information herein is accurate and reliable, but no guarantees are made or implied regarding its use or any infringements of intellectual property rights or other rights of third parties.