

Description

PXXXXSC series thyristors are a type of semi-conduct component. They are designed in modems, telephones, line cards, answering machines, FAX machines, SLICs, T1/E1, xDSL, PBXs and more applications.

Features

- Surface mount package to optimize board space
- Low profile package
- Bidirectional crowbar protection
- Low leakage current : I = 5uA max
- Low on-state voltage
- Low Capacitance
- Solid-state silicon technology
- Eliminates overvoltage caused by fast rising transients

Dimensions & Symbol (Unit: mm Max)

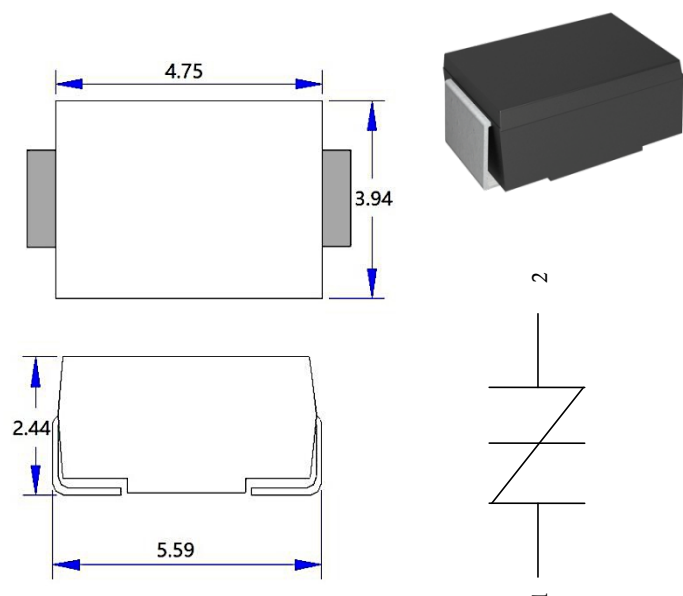

Mechanical Characteristics

- Package: SMB/DO-214AA
- Case Material: "Green" Molding Compound.
- UL Flammability Classification Rating 94V-0
- Standard Packaging: 12mm tape (EIA STD RS-481)
- Weight: 0.10g
- Terminal Connections: See Diagram Below
- Marking Information: See Below

Applications Standards

- TIA-968-A/B
- ITU K.20/21 Enhanced Level*
- ITU K.20/21 Basic Level*
- GR 1089 Inter-building*
- GR 1089 Intra-building
- IEC 61000-4-5 2nd edition
- YD/T 1082 YD/T 993 YD/T 950

Marking Information



Details marking code reference customer approval list

Ordering Information

Out line	Reel (pcs)	Per carton (pcs)	Reel diameters (mm)
Taping	3K	48K	330

Absolute Maximum Ratings ($T_A=25^{\circ}\text{C}$, RH=45%-75%, unless otherwise noted)

Parameter	Symbol	Value	Unit
Storage temperature range	T_{stg}	-60 to +150	$^{\circ}\text{C}$
Operating junction temperature range	T_j	-40 to +150	$^{\circ}\text{C}$
Repetitive peak pulse current	I_{PP}	150	A

Electrical Characteristics Curve ($T_A=25^{\circ}\text{C}$)

Symbol	Parameter
V_{DRM}	Peak off-state voltage
I_{DRM}	Off-state current
V_S	Switching voltage
I_S	Switching current
V_T	On-state voltage
I_T	On-state current
I_H	Holding current
C_O	Off-state capacitance

V-I Curve

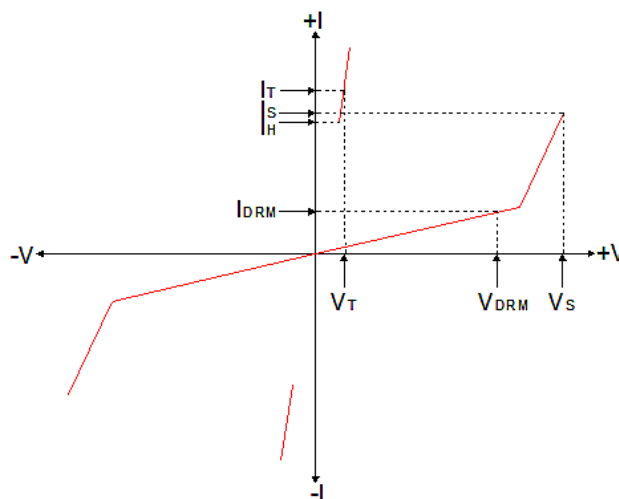

Surge Ratings

Series	I_{PP} (A) min			
	2×10us	8×20us	10×360us	10×1000us
C	500	400	175	100

Part Number Code

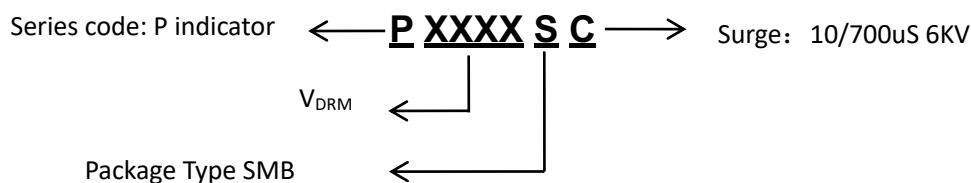

Electrical Characteristics ($T_A=25^{\circ}\text{C}$,)

Part Number	$I_{\text{DRM}}@V_{\text{DRM}}$		$V_s^{①}@I_s$		$V_T@I_T$		I_H	$C_o^{②}$
	μA	V	V	mA	V	A	mA	pF
	max	min	max	max	max	max	min	max
P0080SC	5	6	20	800	4	2.2	25	80
P0220SC	5	15	28	800	4	2.2	35	80
P0300SC	5	25	40	800	4	2.2	50	80
P0640SC	5	58	77	800	4	2.2	120	65
P0720SC	5	65	88	800	4	2.2	120	65
P0900SC	5	75	98	800	4	2.2	120	65
P1100SC	5	90	130	800	4	2.2	120	65
P1300SC	5	120	160	800	4	2.2	120	65
P1500SC	5	140	180	800	4	2.2	120	65
P1800SC	5	170	220	800	4	2.2	120	60
P2000SC	5	180	220	800	4	2.2	120	60
P2300SC	5	190	260	800	4	2.2	120	60
P2600SC	5	220	300	800	4	2.2	120	55
P3100SC	5	275	350	800	4	2.2	120	70
P3500SC	5	320	400	800	4	2.2	120	50
P3800SC	5	360	460	800	4	2.2	120	50
P4200SC	5	400	540	800	4	2.2	120	45

① V_s is measured at 100KV/s

② Off-state capacitance is measured in $V_{\text{DC}}=2\text{V}$, $V_{\text{RMS}}=1\text{V}$, $f=1\text{MHz}$

Soldering Parameters

Reflow Condition		Pb-Free assembly
Pre Heat	-Temperature Min ($T_{s(min)}$)	+150°C
	-Temperature Max ($T_{s(max)}$)	+200°C
	-Time (Min to Max) (ts)	60-180 secs.
Average ramp up rate (Liquid us Temp (T_L) to peak)		3°C/sec. Max
$T_{s(max)}$ to T_L - Ramp-up Rate		3°C/sec. Max
Reflow	-Temperature (T_L) (Liquid us)	+217°C
	-Temperature(t_L)	60-150 secs.
Peak Temp (T_p)		+260(+0/-5)°C
Time within 5°C of actual Peak Temp (t_p)		30 secs. Max
Ramp-down Rate		6°C/sec. Max
Time 25°C to Peak Temp (T_P)		8 min. Max
Do not exceed		+260°C

FIG.1: tr × td pulse waveform

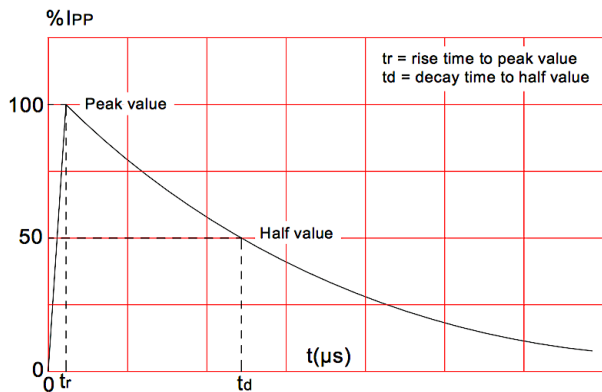

FIG.2: Reflow condition

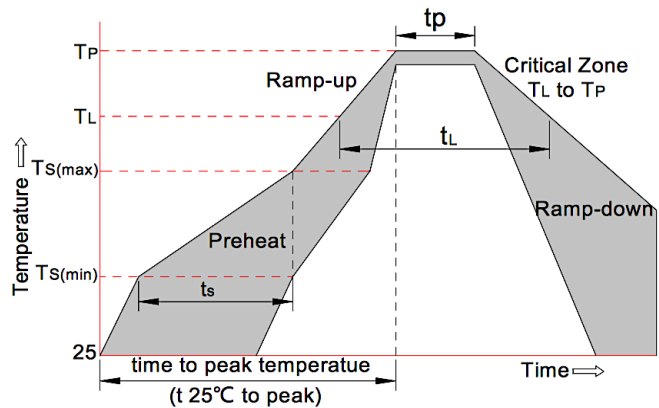

FIG.3: Normalized Vs change vs. junction temperature

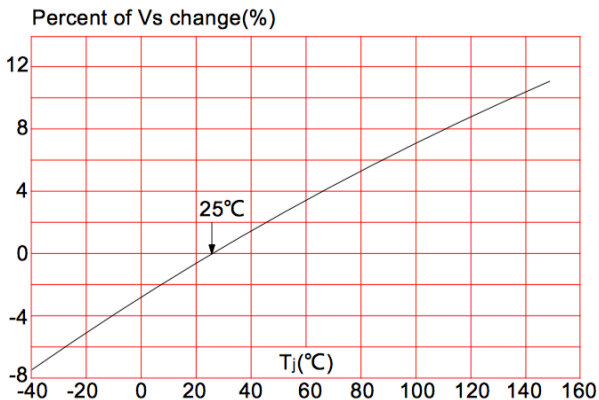
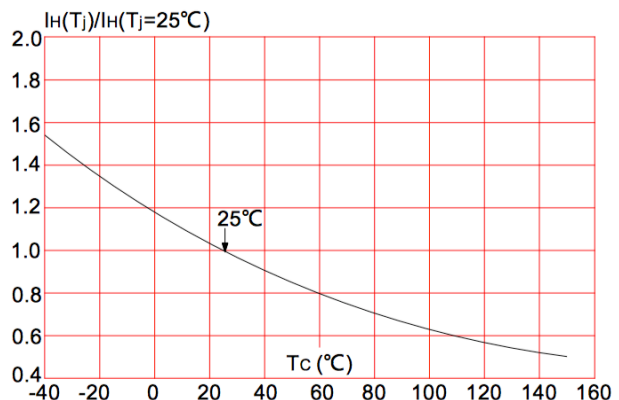
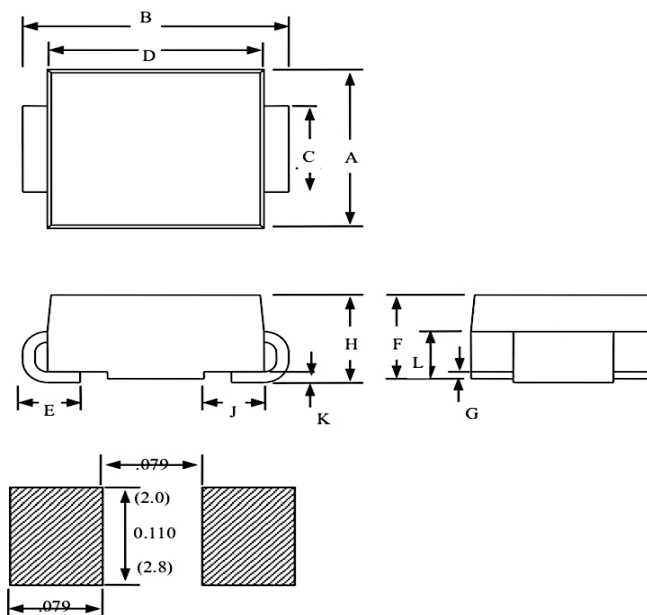

FIG.4: Normalized DC holding current vs. case temperature



Package Mechanical Data

Dimension	Inches		Millimeters	
	MIN	MAX	MIN	MAX
A	0.134	0.155	3.40	3.94
B	0.205	0.22	5.21	5.59
C	0.075	0.083	1.90	2.11
D	0.166	0.185	4.22	4.70
E	0.036	0.056	0.91	1.42
F	0.073	0.087	1.85	2.2
G	0.002	0.008	0.05	0.20
H	0.077	0.094	1.95	2.40
J	0.043	0.053	1.09	1.35
K	0.008	0.014	0.20	0.35
L	0.039	0.049	0.99	1.24



Tape & Reel Specification - SMB

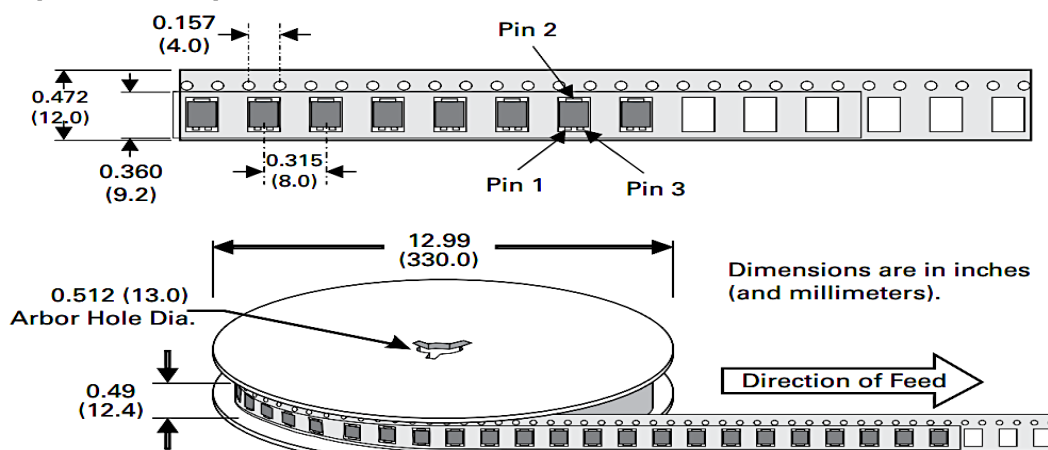

Contact Information

WPMTEK Incorporated Limited

Room 207,2nd Floor, Block 3,Minxing Industry Park, Minzhi,

Longhua New District, Shenzhen, PRC.

TEL: 86755-29308003

FAX: 86755-23739900

Wpmtek Incorporated Limited (WPM) reserves the right to make changes to the product specification and data in this document without notice. WPM makes no warranty, representation or guarantee regarding the suitability of its products for any particular purpose, nor does WPM assume any liability arising from the application or use of any products or circuits, and specifically dis-claims any and all liability, including without limitation special, consequential or incidental damages.