

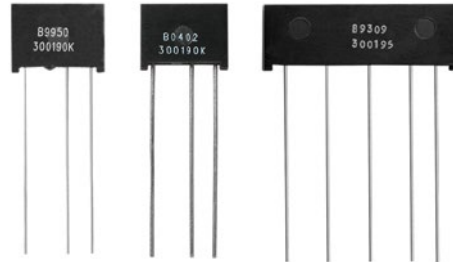
Ultra High Precision Z Foil Voltage Divider and Network Resistor  
with TCR Tracking to 0.1 ppm/°C and Resistance Match to ±0.005% (50 ppm)

FEATURES

- Resistance range: 5 Ω to 100 kΩ per resistive element (any ohmic value ratio is available within resistance range)
- Temperature coefficient of resistance (TCR): ±0.2 ppm/°C typical (0°C to +125°C, +25°C ref.)  
TCR Tracking from 0.1 ppm/°C
- Power coefficient “DR due to self heating”: 5 ppm at rated power
- Ratio match tolerance: to 0.005% (50 ppm)
- Resistance ratio stability: to 0.01% (0.2 W per element, 70°C, 2,000 hrs)
- Electrostatic discharge (ESD) at least to 25 kV
- Short time overload: 0.002%
- Power rating to: +125°C: 0.3 W per element
- Thermal EMF: 0.05 μV/°C
- Non hot spot design
- Thermal stabilization time < 1 s (nominal value achieved within 10 ppm of steady state value)
- Current noise: 0.010 μVRMS/V of applied voltage (<-40 dB)
- Rise time: 1 ns without ringing
- Non-inductive: 0.08 μH
- Voltage coefficient 0.1 ppm/V
- Prototype quantities are available, please contact foil@vpgsensors.com
- Terminal finishes available: lead (Pb)-free, tin/lead alloy\*

APPLICATIONS

- Instrumentation amplifiers
- Bridge networks
- Differential amplifiers



Any value at any tolerance available within resistance range

- Military, airborne and space
- EB applications
- Down-hole (high temperature)
- Medical
- Automatic test equipment (ATE)

INTRODUCTION

The 2R, 3R, 4R Resistor Networks are the designers' first choice for ultra high precision, stable and reliable Voltage Divider or Network.

The Z Foil Technology provides a significant reduction of the resistive component's sensitivity to ambient temperature variations (TCR) and applied power changes, self-heating (PCR). Absolute TCR of 0.2 ppm/°C typical removes errors due to temperature gradients.

The availability of low absolute TCR and low PCR, provides a good cost solution for the variability of other components when compiling the total error budget.

The four fundamental factors determining how “ideal” a precision divider and network will be:

Figure 1 – Power Derating Curve

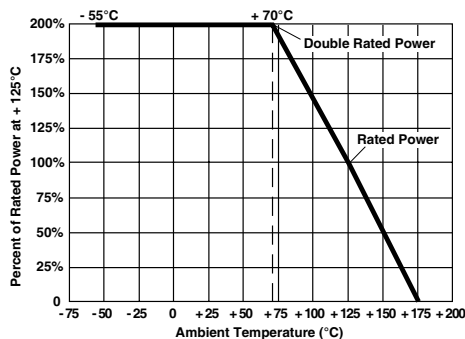
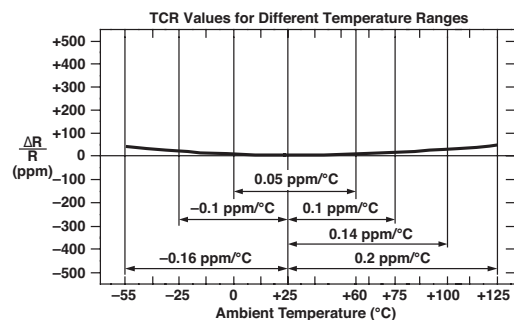


Figure 2 – Typical TCR Curve Z Foil



\* This datasheet provides information about parts that are RoHS-compliant and/or parts that are non-RoHS-compliant. For example, parts with lead (Pb) terminations are not RoHS compliant. Please see the information/tables in this datasheet for details.

# Custom Networks, 2-, 3- or 4-Resistors (Z Foil Technology)

1. Initial tolerance, or how close to nominal value the resistors can be made.
2. Initial ratio matching – or how accurately a specified ratio among resistors will be achieved.
3. Tracking in operation – or how precisely the initial ratios are maintained under a wide range of operating conditions (temperature, humidity, load, etc.)
4. Fast response without ringing – or ability of the divider, network to react to rapid switching without blocking the circuit. This depends on the inductance and capacitance of the network, as well as of the individual resistors in the network.

The 2R, 3R, 4R with the Z Foil technology is designed and manufactured to eliminate the inter-parameter compromise inherent in all other types of precision resistors. All important characteristics – tolerance, long term shelf life and load stability, temperature coefficient, noise, capacitance and inductance – are optimum, approaching in total performances the theoretical ideal, straight wire.

The 2R, 3R, 4R (Z Foil) maintain all their design, physical and electrical characteristics. These factors are both measurable and predictable before, during and after manufacture.

## WHY IS THE ABSOLUTE TCR OF EACH RESISTOR MORE IMPORTANT THE INITIAL TCR TRACKING?

Depending on technology differences, some resistors may increase in value with an increase in temperature (+TCR) while others will decrease in value with an increase in temperature (-TCR), or, they may not change in value at the same rate. Other temperature effects, such as self heating due to the application of power can add to the ambient temperature effects. An example of these effects can be seen where two resistors with different TCR characteristics are used around an operation amplifier. The amplification ratio will be affected by the differential TCR of the resistors and will be compounded by the self heating effects of the  $I^2R$  differences of the feedback vs. the sense resistor. Good design practice would be to use fundamentally low TCR networks in this application since this would minimize both varying temperature and self heating effects.

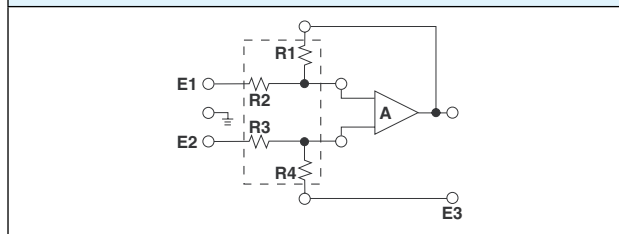
This could not be accomplished with high TCR resistors, even with good tracking.

Our application engineering department is available to advise and make recommendations. For non-standard technical requirements and special applications. Please contact us.

## POST MANUFACTURING OPERATIONS OR PMO

Military applications can include requirements for performance under conditions of stress beyond the normal and over extended periods of time. This calls for more than just selecting a standard device and applying it to a circuit. The standard device may turn out to be all that is needed but an analysis of the projected service conditions should be made and it may well dictate a routine of stabilization known as post manufacturing operations or PMO. The PMO operations that will be discussed are only applicable to Bulk Metal Foil resistors. They stabilize Bulk Metal Foil resistors while they are harmful to other resistor technologies. Short time overload, accelerated load life, and temperature cycling are the three PMO exercises that do the most to remove the anomalies down the road. Bulk Metal Foil resistors are inherently stable as manufactured. These PMO exercises are only of value on Bulk Metal Foil resistors and they improve the performance by small but significant amounts. Users are encouraged to contact the Vishay Foil Resistors application engineering department for assistance in choosing the PMO operations that are right for their application.

**Figure 4— Model 300198 Network**  
(application example)



**Figure 3— Trimming to Values** (conceptual illustration)

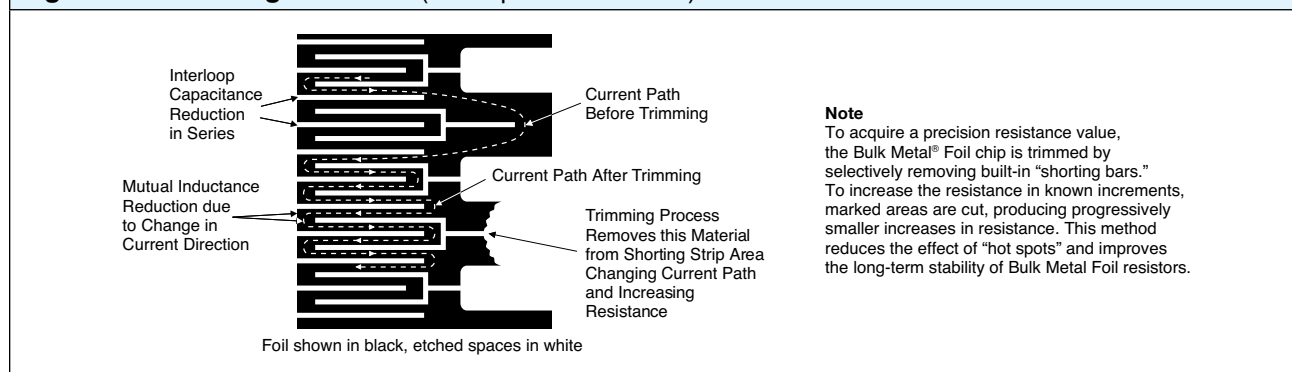


Table 1 – Typical Performance Characteristics <sup>(1)</sup>		
PARAMETER		VALUE
Resistance Temp Characteristic (TCR)		±0.2 ppm/°C
TCR Tracking to Reference Element		0.1 ppm/°C to 4 ppm/°C <sup>(2)</sup>
Max Ambient Temp. at Rated Wattage		+125°C
Max Ambient Temp. at Zero Power		+175°C
Thermal Shock	$\Delta R$ <sup>(3)</sup>	0.002% (20 ppm)
	$\Delta Ratio$ <sup>(4)</sup>	0.002% (20 ppm)
Low Temperature Operation	$\Delta R$	0.005% (50 ppm)
	$\Delta Ratio$	0.002% (20 ppm)
Short Time Overload	$\Delta R$	0.002% (20 ppm)
	$\Delta Ratio$	0.002% (20 ppm)
Terminal Strength	$\Delta R$	0.001% (10 ppm)
	$\Delta Ratio$	0.001% (10 ppm)
Resistance to Soldering Heat	$\Delta R$	0.002% (20 ppm)
	$\Delta Ratio$	0.001% (10 ppm)
Moisture Resistance	$\Delta R$	0.003% (30 ppm)
	$\Delta Ratio$	0.003% (30 ppm)
Shock	$\Delta R$	0.001% (10 ppm)
	$\Delta Ratio$	0.001% (10 ppm)
Vibration High Frequency	$\Delta R$	0.001% (10 ppm)
	$\Delta Ratio$	0.001% (10 ppm)
Life	0.3 W at +125°C	$\Delta R$ 0.01% (100 ppm)
		$\Delta Ratio$ 0.01% (100 ppm)
	0.02 W at +60°C	$\Delta R$ 0.003% (30 ppm)
		$\Delta Ratio$ 0.001% (10 ppm)
	0.05 W at +25°C	$\Delta R$ 0.002% (20 ppm)
	$\Delta Ratio$ 0.001% (10 ppm)	
High Temperature Exposure	$\Delta R$	0.01% (100 ppm)
	$\Delta Ratio$	0.01% (100 ppm)
Low Temperature Storage	$\Delta R$	0.002% (20 ppm)
	$\Delta Ratio$	0.002% (20 ppm)
Insulation Resistance		>500,000 M $\Omega$
Dielectric Withstanding Voltage		No change
Voltage Coefficient <sup>(5)</sup>	$\Delta R$	0.1 ppm/V <sup>(5)</sup>
	$\Delta Ratio$	0.1 ppm/V <sup>(5)</sup>
Noise		0.010 $\mu V_{RMS}/V$ of applied voltage (<-40 dB)
Inductance		0.08 $\mu H$
Capacitance		0.5 pF
Rise Time		1 ns at 1 k $\Omega$
Thermal EMF Lead to Lead		0.05 $\mu V/^\circ C$
Thermal EMF Air Circulation		0.02 $\mu V/^\circ C$
Thermal EMF Power		0.1 $\mu V$ for 20 mW
Shelf Life	$\Delta R$ <sup>(6)</sup>	25 ppm/year
	$\Delta Ratio$ <sup>(6)</sup>	10 ppm/year

<sup>(1)</sup> Measurement error 0.01 R.

<sup>(2)</sup> Depending on construction and ratio value.

<sup>(3)</sup>  $\Delta R$ : absolute resistance range.

<sup>(4)</sup>  $\Delta Ratio$ : change in ratio between resistors within the network package from before to after the specified test.

<sup>(5)</sup> Measured <0.1 ppm/V and within the measurement capability of the equipment. Voltage coefficient is "essentially zero".

<sup>(6)</sup> 2 ppm when in hermetically sealed package.

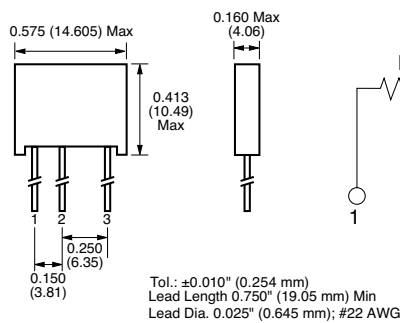
**Table 2—Model 2R, 3R, 4R (Z Foil) Specifications**

Model	Resistance Values	Absolute TCR (-55°C To +125°C, +25°C Ref.)	Tolerance		TCR Tracking (Max.)*	
		Typical And Max. Spread	Absolute	Match	Same Values	Different Values
2R, 3R, 4R (Z Foil)	500 Ω to 100 kΩ	±0.2 ppm/°C ±1.8 ppm/°C	±0.005%	0.005%	0.8 ppm/°C	1.5 ppm/°C
	100 Ω to 500 Ω			0.01%	1.2 ppm/°C	2.0 ppm/°C
	50 Ω to 100 Ω	±0.2 ppm/°C ±2.3 ppm/°C	±0.01%	0.02%	1.5 ppm/°C	2.5 ppm/°C
	25 Ω to 50 Ω	±0.2 ppm/°C ±2.8 ppm/°C	±0.01%	0.02%	2.0 ppm/°C	3.0 ppm/°C
	10 Ω to 25 Ω	±0.2 ppm/°C ±3.3 ppm/°C	±0.02%	0.04%	2.5 ppm/°C	3.5 ppm/°C
	5 Ω to 10 Ω	±0.2 ppm/°C ±3.8 ppm/°C	±0.05%	0.05%	3.0 ppm/°C	4.0 ppm/°C

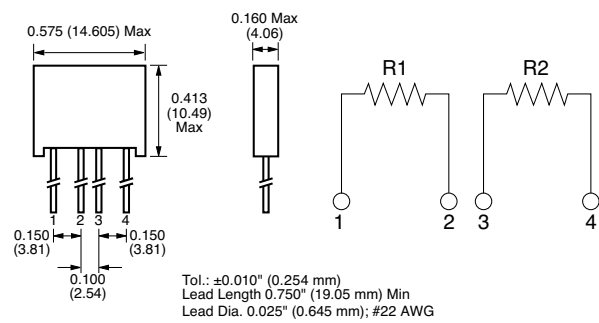
\* TCR tracking of 0.1 ppm/°C to 1.2 ppm/°C is available depending on construction and the ratio between the values.

**Figure 5—Molded 2R, 3R, 4R Resistor Network Dimensions and Circuit Design**  
in inches (millimeters)

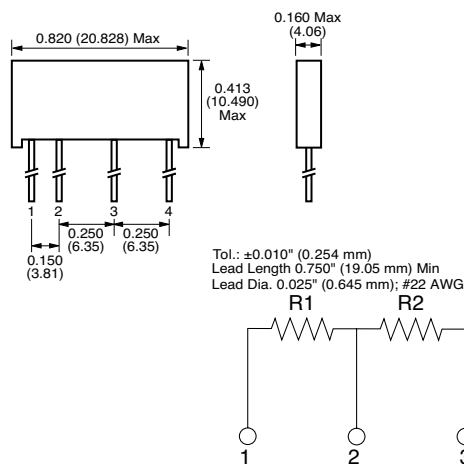
**MODEL 300190Z (with Z Foil Technology)**



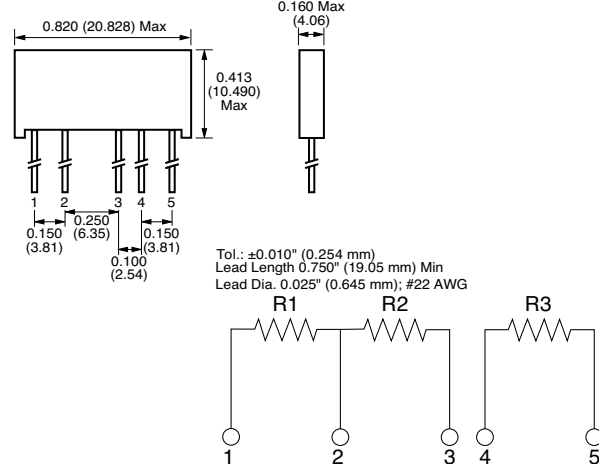
**MODEL 300191Z (with Z Foil Technology)**



**MODEL 300192Z (with Z Foil Technology)**

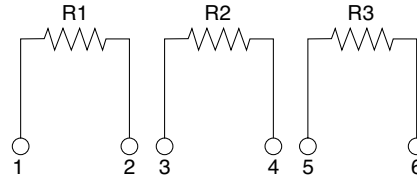
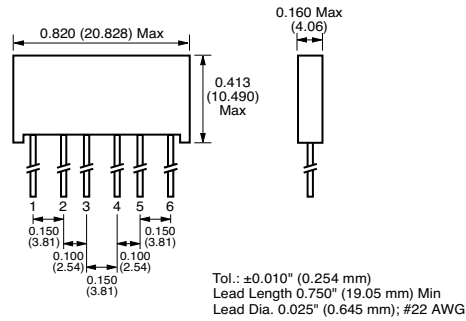


**MODEL 300193Z (with Z Foil Technology)**

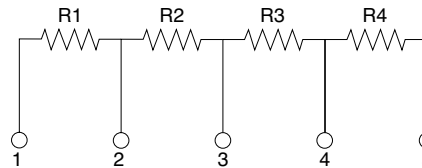
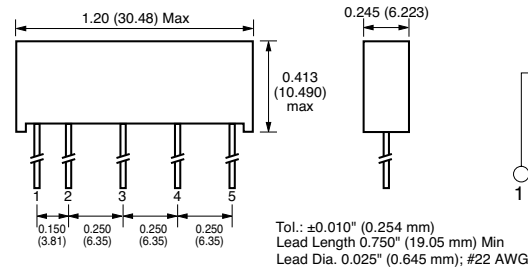


**Figure 6—Molded 2R, 3R, 4R Resistor Network Dimensions and Circuit Design**  
in inches (millimeters)

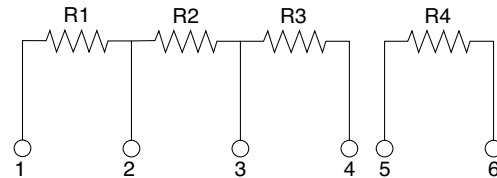
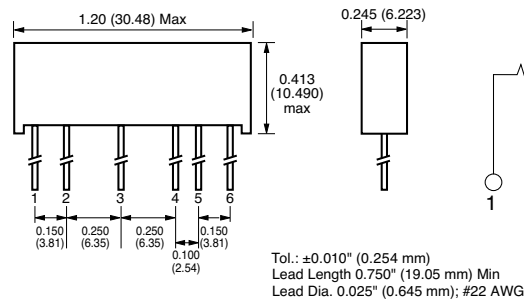
**MODEL 300194Z**  
(with Z Foil Technology)



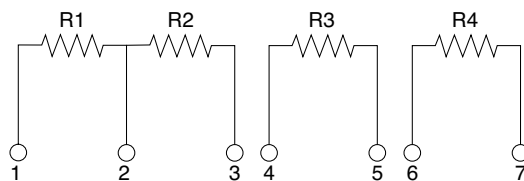
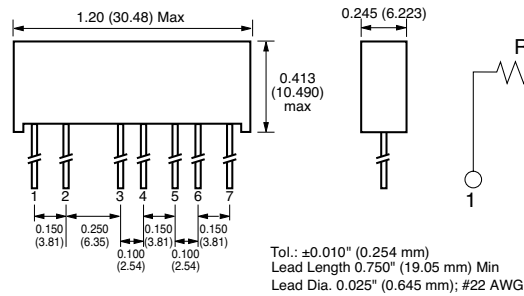
**MODEL 300195Z**  
(with Z Foil Technology)



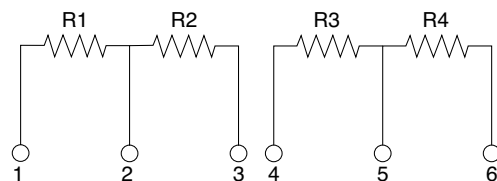
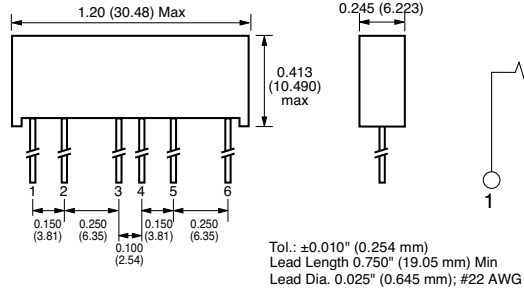
**MODEL 300196Z**  
(with Z Foil Technology)



**MODEL 300197Z**  
(with Z Foil Technology)



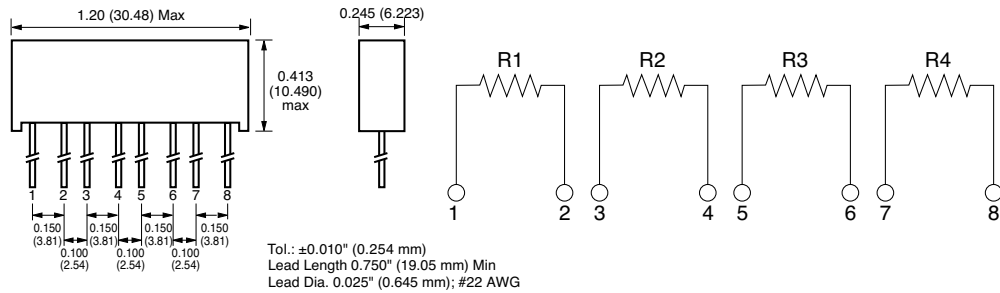
**MODEL 300198Z**  
(with Z Foil Technology)



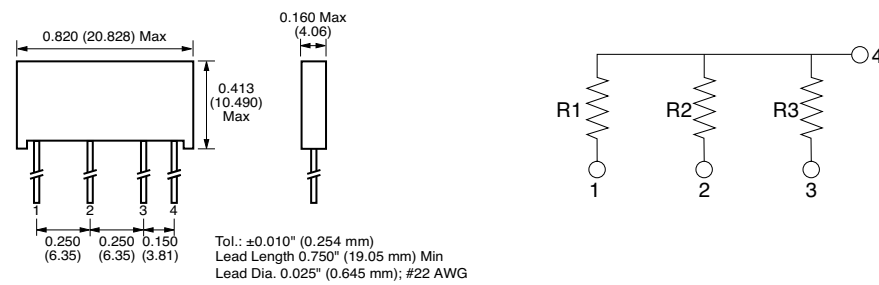
# Custom Networks, 2-, 3- or 4-Resistors (Z Foil Technology)

**Figure 7 – Molded 2R, 3R, 4R Resistor Network Dimensions and Circuit Design**  
in inches (millimeters)

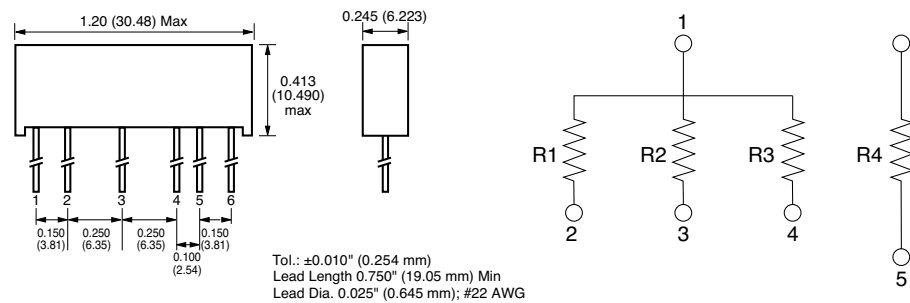
**MODEL 300199Z**  
(with Z Foil Technology)



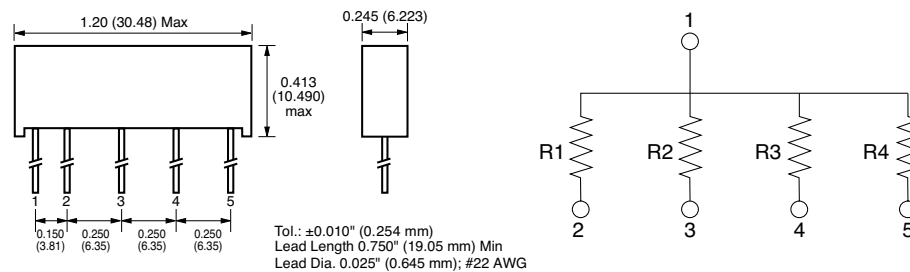
**MODEL 300210Z**  
(with Z Foil Technology)



**MODEL 300211Z**  
(with Z Foil Technology)



**MODEL 300212Z**  
(with Z Foil Technology)



## ORDERING INFORMATION—MOLDED 2R, 3R AND 4R RESISTOR NETWORKS WITH Z FOIL TECHNOLOGY

Networks are built to your requirements. Send your schematic and electrical requirements to the Applications Engineering Department (foil@vpgsensors.com). A unique part number will be assigned which defines all aspects of your network.

## Disclaimer

ALL PRODUCTS, PRODUCT SPECIFICATIONS AND DATA ARE SUBJECT TO CHANGE WITHOUT NOTICE.

Vishay Precision Group, Inc., its affiliates, agents, and employees, and all persons acting on its or their behalf (collectively, "VPG"), disclaim any and all liability for any errors, inaccuracies or incompleteness contained herein or in any other disclosure relating to any product.

The product specifications do not expand or otherwise modify VPG's terms and conditions of purchase, including but not limited to, the warranty expressed therein.

VPG makes no warranty, representation or guarantee other than as set forth in the terms and conditions of purchase. **To the maximum extent permitted by applicable law, VPG disclaims (i) any and all liability arising out of the application or use of any product, (ii) any and all liability, including without limitation special, consequential or incidental damages, and (iii) any and all implied warranties, including warranties of fitness for particular purpose, non-infringement and merchantability.**

Information provided in datasheets and/or specifications may vary from actual results in different applications and performance may vary over time. Statements regarding the suitability of products for certain types of applications are based on VPG's knowledge of typical requirements that are often placed on VPG products. It is the customer's responsibility to validate that a particular product with the properties described in the product specification is suitable for use in a particular application. You should ensure you have the current version of the relevant information by contacting VPG prior to performing installation or use of the product, such as on our website at [vpgsensors.com](http://vpgsensors.com).

No license, express, implied, or otherwise, to any intellectual property rights is granted by this document, or by any conduct of VPG.

The products shown herein are not designed for use in life-saving or life-sustaining applications unless otherwise expressly indicated. Customers using or selling VPG products not expressly indicated for use in such applications do so entirely at their own risk and agree to fully indemnify VPG for any damages arising or resulting from such use or sale. Please contact authorized VPG personnel to obtain written terms and conditions regarding products designed for such applications.

Product names and markings noted herein may be trademarks of their respective owners.

Copyright Vishay Precision Group, Inc., 2014. All rights reserved.