

Aluminum Electrolytic Capacitors SMD (Chip), High Temperature, Low Impedance

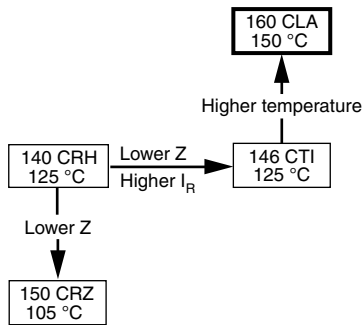


Fig. 1

QUICK REFERENCE DATA	
DESCRIPTION	VALUE
Nominal case sizes (L x W x H in mm)	12.5 x 12.5 x 13 to 18 x 18 x 21
Rated capacitance range, C_R	47 μ F to 3300 μ F
Tolerance on C_R	± 20 %
Rated voltage range, U_R	16 V to 80 V
Category temperature range	-55 °C to +150 °C
Endurance test at 150 °C	1000 h to 1500 h
Useful life at 150 °C	1000 h to 2000 h
Useful life at 40 °C 1.8 x I_R applied	300 000 h to 400 000 h
Shelf life at 0 V, 150 °C	1000 h
Based on sectional specification	IEC 60384-18 / CECC 32300
Climatic category IEC 60068	55 / 150 / 56

FEATURES

- Useful life: up to 2000 h at 150 °C
- High reliability
- Low ESR
- Polarized aluminum electrolytic capacitors, non-solid electrolyte, self healing
- SMD-version with base plate, lead (Pb)-free reflow solderable
- Charge and discharge proof, no peak current limitation
- High temperature reflow soldering according to JEDEC® J-STD-020
- High temperature proof
- Vibration proof, 4-pin version and 6-pin version
- AEC-Q200 qualified
- Material categorization: for definitions of compliance please see www.vishay.com/doc?99912

 AUTOMOTIVE
GRADE

RoHS
COMPLIANT

APPLICATIONS

- SMD technology, for high temperature reflow soldering
- High temperature environment, high peak load
- Automotive, industrial
- Smoothing, filtering, buffering

MARKING

- Rated capacitance (in μ F)
- Rated voltage (in V)
- Date code, in accordance with IEC 60062
- Black mark or “-” sign indicating the cathode (the anode is identified by bevelled edges)
- Code indicating group number (A)

PACKAGING

Supplied in blister tape on reel

SELECTION CHART FOR C_R, U_R, AND RELEVANT NOMINAL CASE SIZES (L x W x H in mm)						
C_R (μF)	U_R (V)					
	16	25	35	50	63	80
47	→	→	→	→	12.5 x 12.5 x 13	-
68	→	→	→	→	12.5 x 12.5 x 13	12.5 x 12.5 x 13
100	→	→	→	12.5 x 12.5 x 13	12.5 x 12.5 x 13	12.5 x 12.5 x 16
150	→	→	→	12.5 x 12.5 x 13	12.5 x 12.5 x 16	16 x 16 x 16
220	→	→	12.5 x 12.5 x 13	12.5 x 12.5 x 16	16 x 16 x 16	18 x 18 x 16
330	→	12.5 x 12.5 x 13	12.5 x 12.5 x 13	16 x 16 x 16	18 x 18 x 16	18 x 18 x 21
470	12.5 x 12.5 x 13	12.5 x 12.5 x 13	16 x 16 x 16	18 x 18 x 16	16 x 16 x 21	-
680	12.5 x 12.5 x 13	16 x 16 x 16	18 x 18 x 16	16 x 16 x 21	18 x 18 x 21	-
1000	16 x 16 x 16	18 x 18 x 16	16 x 16 x 21	18 x 18 x 21	-	-
1500	18 x 18 x 16	16 x 16 x 21	18 x 18 x 21	-	-	-
2200	16 x 16 x 21	18 x 18 x 21	-	-	-	-
2700	18 x 18 x 21	-	-	-	-	-
3300	18 x 18 x 21	-	-	-	-	-

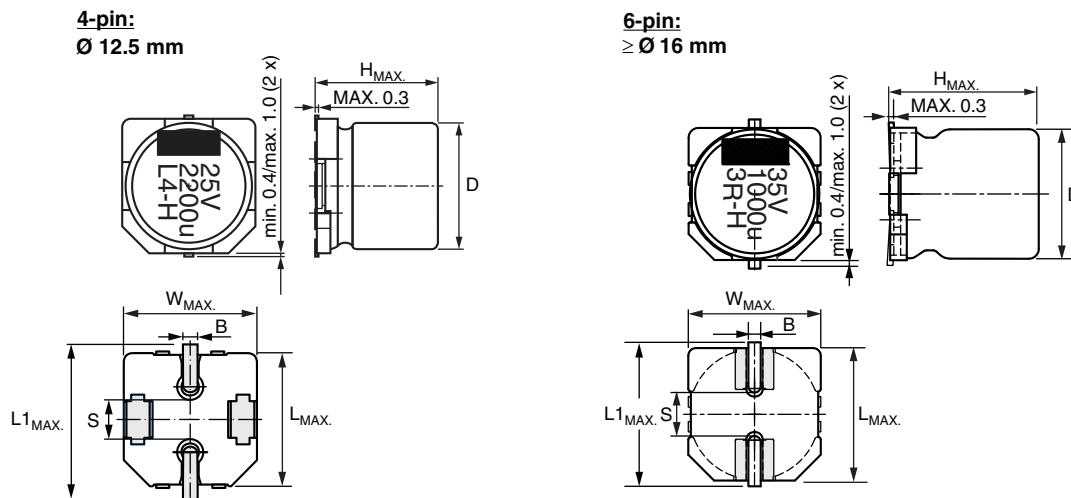


Fig. 2 - Dimensional outline

Table 1

DIMENSIONS in millimeters AND MASS									
NOMINAL CASE SIZE L x W x H	CASE CODE	$L_{MAX.}$	$W_{MAX.}$	$H_{MAX.}$	$\varnothing D$	$B_{MAX.}$	S	$L1_{MAX.}$	MASS (g)
12.5 x 12.5 x 13	1213	12.9	12.9	14.0	12.5	1.3	3.6	14.9	≈ 2.9
12.5 x 12.5 x 16	1216	12.9	12.9	16.5	12.5	1.3	3.6	14.9	≈ 3.2
16 x 16 x 16	1616	16.6	16.6	17.5	16.0	1.3	6.5	18.6	≈ 5.8
16 x 16 x 21	1621	16.6	16.6	22.0	16.0	1.3	6.5	18.6	≈ 7.1
18 x 18 x 16	1816	19.0	19.0	17.5	18.0	1.3	6.5	21.0	≈ 8.0
18 x 18 x 21	1821	19.0	19.0	22.0	18.0	1.3	6.5	21.0	≈ 9.3

Table 2

TAPE AND REEL DIMENSIONS in millimeters, PACKAGING QUANTITIES						
NOMINAL CASE SIZE L x W x H	CASE CODE	PITCH P ₁	TAPE WIDTH W	TAPE THICKNESS T ₂	REEL DIAMETER	PACKAGING QUANTITY PER REEL
12.5 x 12.5 x 13	1213	20	24	16.2	380	250
12.5 x 12.5 x 16	1216	24	32	18.5	380	200
16 x 16 x 16	1616	28	44	18.9	380	150
16 x 16 x 21	1621	28	44	23.4	380	100
18 x 18 x 16	1816	32	44	18.9	380	125
18 x 18 x 21	1821	32	44	23.4	380	100

Note

- Detailed tape dimensions see section “PACKAGING”

MOUNTING

The capacitors are designed for automatic placement on to printed-circuit boards.

Optimum dimensions of soldering pads depend amongst others on soldering method, mounting accuracy, print layout and / or adjacent components.

For recommended soldering pad dimensions, refer to Fig. 3 and Table 3.

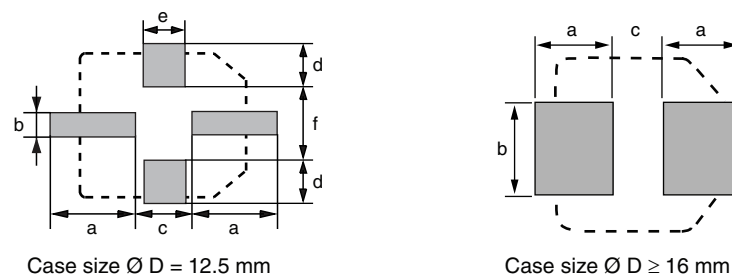
SOLDERING

Soldering conditions are defined by the curve, temperature versus time, where the temperature is that measured on the component during processing.

For maximum conditions refer to Fig. 4.

Any temperature versus time curve which does not exceed the specified maximum curves may be applied.

As a general principle, temperature and duration shall be the **minimum** necessary required to ensure good soldering connections. However, the specified maximum curves should never be exceeded.


Fig. 3 - Recommended soldering pad dimensions
Table 3

RECOMMENDED SOLDERING PAD DIMENSIONS in millimeters						
CASE CODE	a	b	c	d	e	f
1213	6.3	2.5	4.0	4.2	5.0	5.6
1216	6.3	2.5	4.0	4.2	5.0	5.6
1616	7.8	9.6	4.7	-	-	-
1621	7.8	9.6	4.7	-	-	-
1816	8.8	9.6	4.7	-	-	-
1821	8.8	9.6	4.7	-	-	-

**ADVANCED SOLDERING PROFILE FOR LEAD (Pb)-FREE REFLOW PROCESS
ACCORDING TO JEDEC J-STD-020**


Fig. 4 - Maximum temperature load during reflow soldering

Table 4

REFLOW SOLDERING CONDITIONS for MAL216099xxxE3		
PROFILE FEATURES	CASE CODE 1213 TO 1216	CASE CODE 1616 TO 1821
Max. time from 25 °C to T_{Peak}	300 s	300 s
Max. ramp-up rate to 150 °C	3 K/s	3 K/s
Max. time from 150 °C to 200 °C (t_1)	150 s	150 s
Max. time from 190 °C to 200 °C (t_2)	110 s	110 s
Ramp up rate from 200 °C to T_{Peak}	0.5 K/s to 3 K/s	0.5 K/s to 3 K/s
Max. time above $T_{Liquidus}$ (217 °C) (t_3)	90 s	90 s
Max. time above 230 °C (t_4)	65 s	60 s
Peak temperature T_{Peak}	250 °C	245 °C
Max. time above T_{Peak} minus 5 °C	30 s	30 s
Ramp-down rate from $T_{Liquidus}$	3 K/s to 6 K/s	3 K/s to 6 K/s

Notes

- Temperature measuring point on top of the case and on terminals.
- Max. 2 runs with pause of min. 30 min in between.



ELECTRICAL DATA	
SYMBOL	DESCRIPTION
C_R	Rated capacitance at 100 Hz, tolerance $\pm 20\%$
I_R	Rated RMS ripple current at 100 kHz, 150 °C
I_{L2}	Max. leakage current after 2 min at U_R
$\tan \delta$	Max. dissipation factor at 100 Hz
Z	Max. impedance at 100 kHz

ORDERING EXAMPLE

Electrolytic capacitor 160 CLA series

220 μF / 50 V; $\pm 20\%$

Nominal case size: 12.5 mm x 12.5 mm x 16 mm;
taped on reel

Ordering code: MAL216099103E3

Note

- Unless otherwise specified, all electrical values in Table 5 apply at $T_{amb} = 20\text{ °C}$, $P = 86\text{ kPa}$ to 106 kPa , $RH = 45\%$ to 75%

Table 5

ELECTRICAL DATA AND ORDERING INFORMATION									
U_R (V)	C_R (μF)	NOMINAL CASE SIZE L x W x H (mm)	I_R 150 °C 100 kHz (mA)	I_{L2} 2 min (μA)	$\tan \delta$ 100 Hz	Z 100 kHz 20 °C (Ω)	Z 100 kHz -40 °C (Ω)	LIFE CODE ⁽¹⁾	ORDERING CODE MAL2160...
16	470	12.5 x 12.5 x 13	750	75	0.16	0.080	0.70	L2	99501E3
	680	12.5 x 12.5 x 13	800	109	0.16	0.080	0.70	L2	99502E3
	1000	16 x 16 x 16	850	160	0.16	0.050	0.45	L3	99503E3
	1500	18 x 18 x 16	900	240	0.16	0.050	0.45	L3	99504E3
	2200	16 x 16 x 21	1100	352	0.18	0.035	0.32	L5	99505E3
	2700	18 x 18 x 21	1350	432	0.18	0.035	0.32	L5	99506E3
	3300	18 x 18 x 21	1400	528	0.20	0.035	0.32	L5	99507E3
25	330	12.5 x 12.5 x 13	650	83	0.14	0.080	0.70	L2	99601E3
	470	12.5 x 12.5 x 13	700	118	0.14	0.080	0.70	L2	99602E3
	680	16 x 16 x 16	800	170	0.14	0.050	0.45	L3	99603E3
	1000	18 x 18 x 16	830	250	0.14	0.050	0.45	L3	99604E3
	1500	16 x 16 x 21	1050	375	0.14	0.035	0.32	L5	99605E3
35	2200	18 x 18 x 21	1350	550	0.16	0.035	0.32	L5	99606E3
	220	12.5 x 12.5 x 13	550	77	0.12	0.080	0.70	L2	99001E3
	330	12.5 x 12.5 x 13	650	116	0.12	0.080	0.70	L2	99002E3
	470	16 x 16 x 16	800	165	0.12	0.050	0.45	L3	99003E3
	680	18 x 18 x 16	830	238	0.12	0.050	0.45	L3	99004E3
	1000	16 x 16 x 21	1000	350	0.12	0.035	0.32	L5	99005E3
50	1500	18 x 18 x 21	1350	525	0.12	0.035	0.32	L5	99006E3
	100	12.5 x 12.5 x 13	420	50	0.10	0.130	1.20	L2	99101E3
	150	12.5 x 12.5 x 13	450	75	0.10	0.120	1.10	L2	99102E3
	220	12.5 x 12.5 x 16	550	110	0.10	0.085	0.76	L2	99103E3
	330	16 x 16 x 16	700	165	0.10	0.072	0.65	L3	99104E3
	470	18 x 18 x 16	720	235	0.10	0.070	0.63	L3	99105E3
	680	16 x 16 x 21	800	340	0.10	0.052	0.47	L5	99106E3
63	1000	18 x 18 x 21	1100	500	0.10	0.049	0.44	L5	99107E3
	47	12.5 x 12.5 x 13	300	30	0.10	0.240	2.16	L1	99801E3
	68	12.5 x 12.5 x 13	320	43	0.10	0.240	2.16	L1	99802E3
	100	12.5 x 12.5 x 13	320	63	0.10	0.240	2.16	L1	99803E3
	150	12.5 x 12.5 x 16	400	95	0.10	0.160	1.44	L2	99804E3
	220	16 x 16 x 16	500	139	0.10	0.100	0.90	L3	99805E3
	330	18 x 18 x 16	520	208	0.10	0.095	0.86	L3	99806E3
	470	16 x 16 x 21	600	296	0.10	0.075	0.68	L5	99807E3
80	680	18 x 18 x 21	700	428	0.10	0.072	0.65	L5	99808E3
	68	12.5 x 12.5 x 13	270	54	0.12	0.780	6.24	L1	99701E3
	100	12.5 x 12.5 x 16	320	80	0.12	0.650	5.20	L1	99702E3
	150	16 x 16 x 16	430	120	0.12	0.390	3.12	L3	99703E3
	220	18 x 18 x 16	430	176	0.12	0.390	3.12	L3	99704E3
80	330	18 x 18 x 21	520	264	0.12	0.300	2.40	L4	99705E3

Note

- ⁽¹⁾ Determines the applicable row in the table "Endurance Test Duration and Useful Life"

Table 6

ADDITIONAL ELECTRICAL DATA		
PARAMETER	CONDITIONS	VALUE
Voltage		
Surge voltage for short periods	IEC 60384-18, subclause 4.14	$U_s \leq 1.15 \times U_R$
Reverse voltage for short periods	IEC 60384-18, subclause 4.16; $T_A \leq 150 \text{ }^\circ\text{C}$	$U_{rev} \leq 1 \text{ V}$
Current		
Leakage current	After 2 min at U_R	$I_{L2} \leq 0.01 \times C_R \times U_R$
Inductance		
Equivalent series inductance (ESL)	$\varnothing D \geq 12.5 \text{ mm}$	Typ. 11 nH
Resistance		
Equivalent series resistance (ESR) at 100 Hz	Calculated from $\tan \delta_{max}$ and C_R (see Table 5)	$ESR = \tan \delta / 2\pi f C_R$

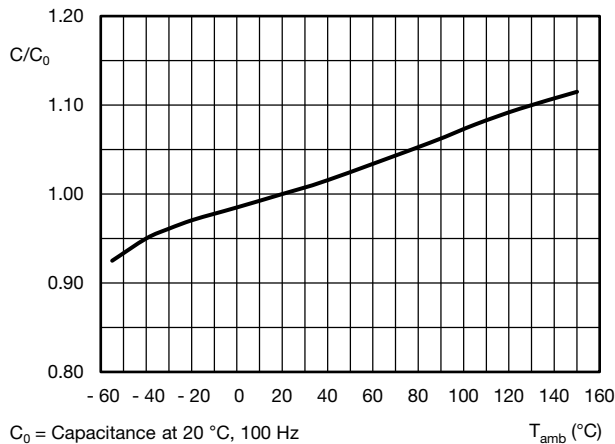
CAPACITANCE (C)


Fig. 5 - Typical multiplier of capacitance as a function of ambient temperature

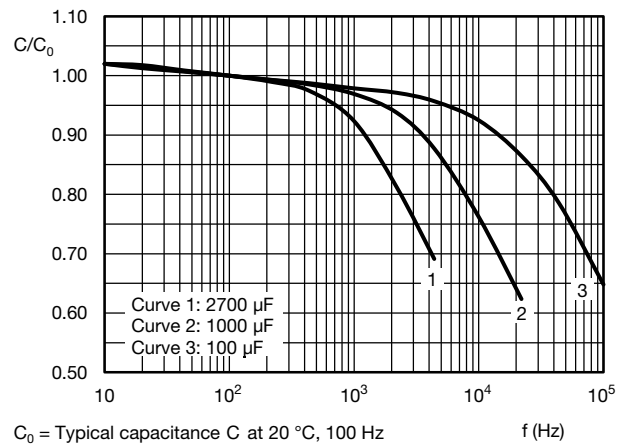


Fig. 6 - Typical multiplier of capacitance as a function of frequency

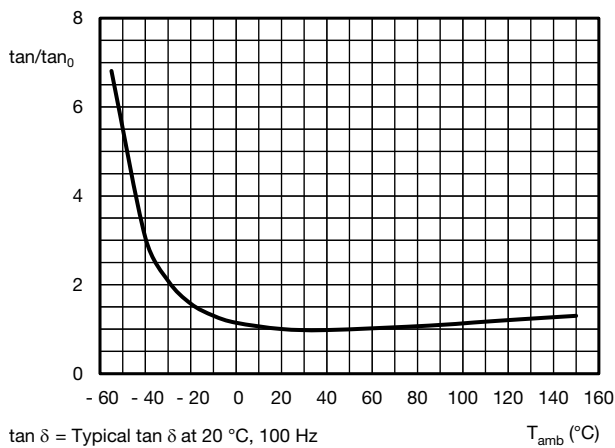
DISSIPATION FACTOR (tan δ)


Fig. 7 - Typical multiplier of dissipation factor (tan δ) as a function of ambient temperature

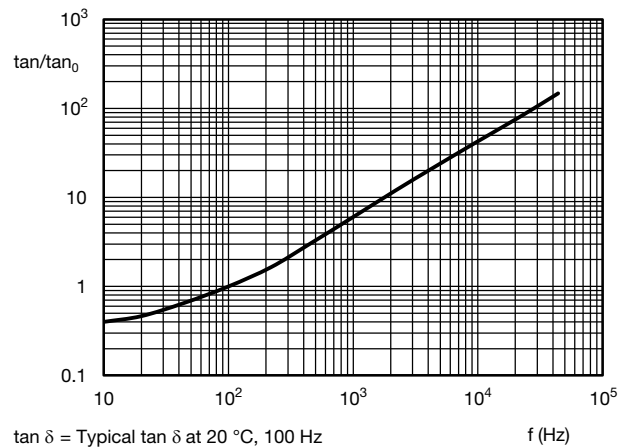


Fig. 8 - Typical multiplier of dissipation factor (tan δ) as a function of frequency



EQUIVALENT SERIES RESISTANCE (ESR)



Fig. 9 - Typical multiplier of ESR as a function of frequency

IMPEDANCE (Z)



Fig. 10 - Typical multiplier of impedance as a function of temperature



Fig. 11 - Typical impedance as a function of frequency



Fig. 12 - Typical impedance as a function of frequency

RIPPLE CURRENT AND USEFUL LIFE

Table 7

ENDURANCE TEST DURATION AND USEFUL LIFE			
LIFE CODE	ENDURANCE AT 150 °C (h)	USEFUL LIFE AT 150 °C (h)	USEFUL LIFE AT 40 °C 1.8 x I _R APPLIED (h)
L1	1000	1000	300 000
L2	1000	1250	325 000
L3	1000	1500	350 000
L4	1500	1500	350 000
L5	1500	2000	400 000

Note

- Multiplier of useful life code: MBC245

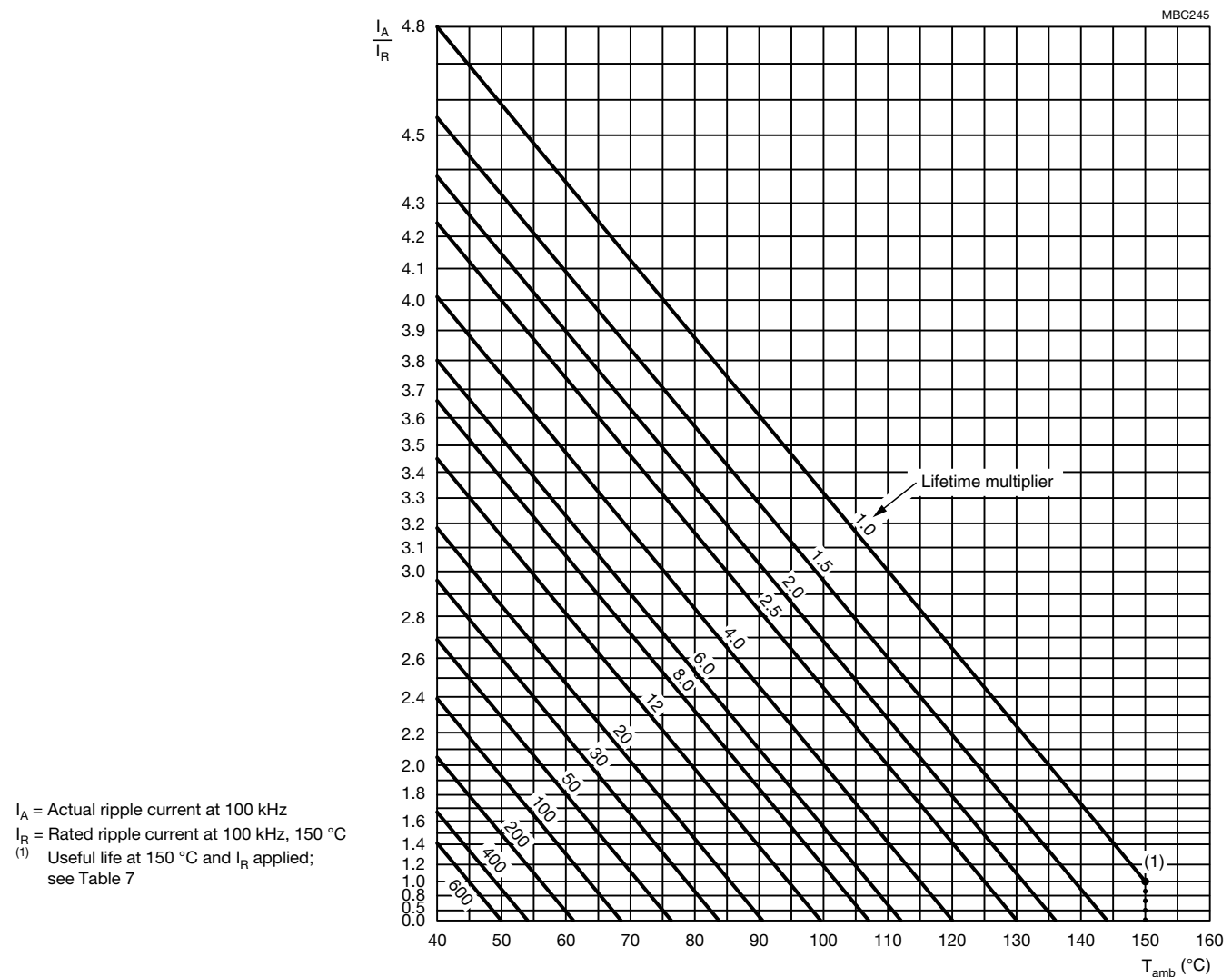


Fig. 13 - Multiplier of useful life as a function of ambient temperature and ripple current load



Table 8

MULTIPLIER OF RIPPLE CURRENT (I_R) AS A FUNCTION OF FREQUENCY							
FREQUENCY (Hz)							
50	100	300	1000	3000	10 000	30 000	100 000
I_R MULTIPLIER							
0.40	0.60	0.75	0.80	0.90	0.95	0.97	1.00

Table 9

TEST PROCEDURES AND REQUIREMENTS			
TEST		PROCEDURE (quick reference)	REQUIREMENTS
NAME OF TEST	REFERENCE		
Mounting	IEC 60384-18, subclause 4.3	Shall be performed prior to tests mentioned below; reflow soldering; for maximum temperature load refer to chapter "Mounting"	$\Delta C/C: \pm 5 \%$ $\tan \delta \leq \text{spec. limit}$ $I_{L2} \leq \text{spec. limit}$
Endurance	IEC 60384-18 / CECC 32300, subclause 4.15	$T_{\text{amb}} = 150 \text{ }^\circ\text{C}$; U_R applied; for test duration see Table 7	$\Delta C/C: \pm 20 \%$ $\tan \delta \leq 2 \times \text{spec. limit}$ $I_{L2} \leq \text{spec. limit}$
Useful life	CECC 30301, subclause 1.8.1	$T_{\text{amb}} = 150 \text{ }^\circ\text{C}$; U_R and I_R applied; for test duration see Table 7	$\Delta C/C: \pm 30 \%$ $\tan \delta \leq 3 \times \text{spec. limit}$ $I_{L2} \leq \text{spec. limit}$ no short or open circuit total failure percentage: $\leq 1 \%$
Shelf life (storage at high temperature)	IEC 60384-18 / CECC 32300, subclause 4.17	$T_{\text{amb}} = 150 \text{ }^\circ\text{C}$; no voltage applied; 1000 h After test: U_R to be applied for 30 min, 24 h to 48 h before measurement	For requirements see "Endurance test" above
Reverse voltage	IEC 60384-18 / CECC 32300, subclause 4.16	$T_{\text{amb}} = 150 \text{ }^\circ\text{C}$: 125 h at $U = -0.5 \text{ V}$, followed by 125 h at U_R	$\Delta C/C: \pm 15 \%$ $\tan \delta \leq 1.5 \times \text{spec. limit}$ $I_{L2} \leq \text{spec. limit}$

Statements about product lifetime are based on calculations and internal testing. They should only be interpreted as estimations. Also due to external factors, the lifetime in the field application may deviate from the calculated lifetime. In general, nothing stated herein shall be construed as a guarantee of durability.



Disclaimer

ALL PRODUCT, PRODUCT SPECIFICATIONS AND DATA ARE SUBJECT TO CHANGE WITHOUT NOTICE TO IMPROVE RELIABILITY, FUNCTION OR DESIGN OR OTHERWISE.

Vishay Intertechnology, Inc., its affiliates, agents, and employees, and all persons acting on its or their behalf (collectively, "Vishay"), disclaim any and all liability for any errors, inaccuracies or incompleteness contained in any datasheet or in any other disclosure relating to any product.

Vishay makes no warranty, representation or guarantee regarding the suitability of the products for any particular purpose or the continuing production of any product. To the maximum extent permitted by applicable law, Vishay disclaims (i) any and all liability arising out of the application or use of any product, (ii) any and all liability, including without limitation special, consequential or incidental damages, and (iii) any and all implied warranties, including warranties of fitness for particular purpose, non-infringement and merchantability.

Statements regarding the suitability of products for certain types of applications are based on Vishay's knowledge of typical requirements that are often placed on Vishay products in generic applications. Such statements are not binding statements about the suitability of products for a particular application. It is the customer's responsibility to validate that a particular product with the properties described in the product specification is suitable for use in a particular application. Parameters provided in datasheets and / or specifications may vary in different applications and performance may vary over time. All operating parameters, including typical parameters, must be validated for each customer application by the customer's technical experts. Product specifications do not expand or otherwise modify Vishay's terms and conditions of purchase, including but not limited to the warranty expressed therein.

Except as expressly indicated in writing, Vishay products are not designed for use in medical, life-saving, or life-sustaining applications or for any other application in which the failure of the Vishay product could result in personal injury or death. Customers using or selling Vishay products not expressly indicated for use in such applications do so at their own risk. Please contact authorized Vishay personnel to obtain written terms and conditions regarding products designed for such applications.

No license, express or implied, by estoppel or otherwise, to any intellectual property rights is granted by this document or by any conduct of Vishay. Product names and markings noted herein may be trademarks of their respective owners.