

REV	ECN	DESCRIPTION	DRFT	DATE
-----	-----	-------------	------	------

NOTES1:

UL Standard

1. Rated voltage/current : 300V / 8A
2. Withstanding voltage : AC1600V/1Min.
3. Torque value : M2 , 1.77Lb.in
4. Wire range : 28~16AWG

IEC Standard

1. Pollution degree	2
Overvoltage category	II
Rate impulse voltage(KV)	2.5KV
Rate voltage(V)	250V
Rate current(A)	7A

2. Torque value : M2 , 0.2N•m
3. Wire range : 0.5~1.5mm<sup>2</sup>

NOTES2:

1. Dimension shall be interpreted per ASME Y14.5-2009
2. Pitch : 3.5/3.81mm, Poles : N=02~24P
3. Stripping length : 6~7mm
4. Operating temperature: -40°C~+105°C
5. Undimensioned tolerances:

Pitch range in mm		Nominal dimension range in mm				-	∩	∇
To	Over	To	Over	To	Over	To	Over	
6	10	10	24	30	60	100	150	0.1/10
±0.15	±0.20	±0.30	±0.30	±0.50	±0.70	±1.00	±1.30	±2'

6. RoHS Compliance

15ET YKM - 3.5/3.81 - XXP - 1Y - 00A (H)

(Series No.) (Pitch) (Poles) (Color) (RoHS) 00A-(Standard)

(Single Pitch)

1. (Grey)
2. (Blue)
3. (Black)
4. (Green)
5. (Orange)
6. (Red)
7. (Transparent)
8. (Yellow)
9. (White)

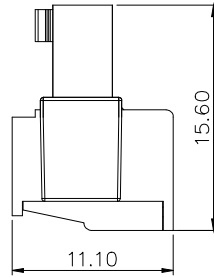
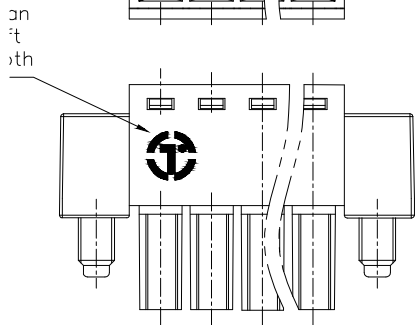
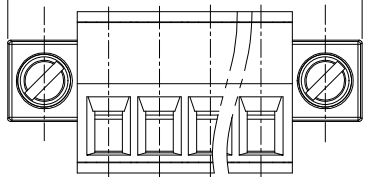
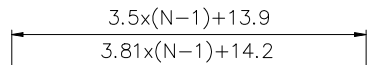
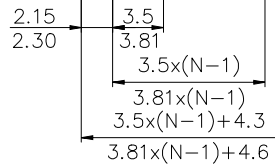
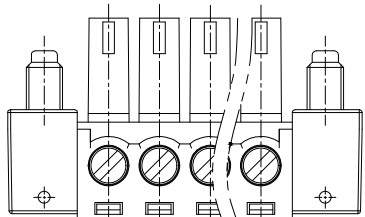
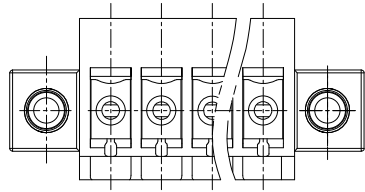

DETACHED LISTS	PART NO.:	拓宜 (上海) 工控电器设备有限公司		
	APPD:	NAME: 15ET YKM-3.5/3.81-XXP-1Y-00AH		
	CHKD:	TITLE: CUSTOMER DRAWING		
	DRFT:	REV	DO	
DRAWING NO.:		SHEET	1/1	
THIRD ANGLE PROJECTION		SCALE	1:1	