

TPS5140

FOUR-CHANNEL DC/DC CONTROLLER FOR NOTEBOOK PC POWER

SLVS305A – DECEMBER 2000 – REVISED JANUARY 2001

- Three Independent Step-Down DC/DC Controllers and One 12-V Boost DC/DC Converter
- 4.5 V – 28 V Input Voltage Range
- Step-Down Controller Output Voltages Adjustable Down to 1.2 V
- Synchronous-Buck Operation for High Efficiency
- PWM Mode Control
- Auto PWM/SKIP Mode for High Efficiency Under All Load Conditions
- High Speed Error Amplifier
- Separate Standby Control and Over Current Protection for Each Channel
- Over Voltage and Under Voltage Protection
- Programmable Short Circuit Protection
- Power Good With Programmable Delay Time
- 5 V and 3.3 V Linear Regulators

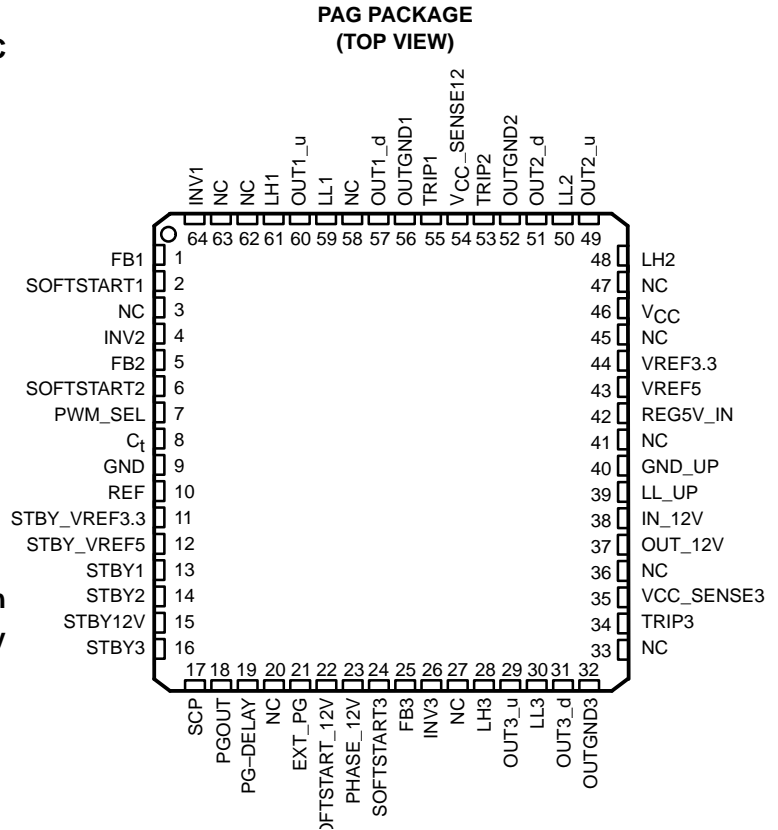

description

The TPS5140 is a dc/dc controller that incorporates three synchronous-buck controllers and one nonsynchronous 12-V boost converter on one chip to power the voltage rails needed by notebook peripheral components. On-chip high-side and low-side synchronous rectifier drivers are integrated to drive less expensive N-channel power MOSFETs. The nonsynchronous boost converter includes the N channel power MOSFET and supports 120 mA for the PCMCIA power supply. The outputs are controlled independently and two of the synchronous-buck controllers operate 180 degrees out of phase, with the third lowering the input current ripple and allowing a smaller input capacitance to reduce power supply cost. For higher efficiency under all load conditions, the TPS5140 automatically adjusts each channel from the PWM mode to the skip mode independently. The skip mode enables a lower operating frequency and shortens the pulse width to the low side MOSFETs, thereby increasing the efficiency under light load conditions. To further extend battery life, the TPS5140 features dead-time control and very low quiescent current. Resistorless current protection and the fixed high-side driver voltage simplify the system design and reduce the external parts count.



Please be aware that an important notice concerning availability, standard warranty, and use in critical applications of Texas Instruments semiconductor products and disclaimers thereto appears at the end of this data sheet.

PRODUCTION DATA information is current as of publication date. Products conform to specifications per the terms of Texas Instruments standard warranty. Production processing does not necessarily include testing of all parameters.



POST OFFICE BOX 655303 • DALLAS, TEXAS 75265

Copyright © 2001, Texas Instruments Incorporated

TPS5140 FOUR-CHANNEL DC/DC CONTROLLER FOR NOTEBOOK PC POWER

SLVS305A – DECEMBER 2000 – REVISED JANUARY 2001

typical design schematic

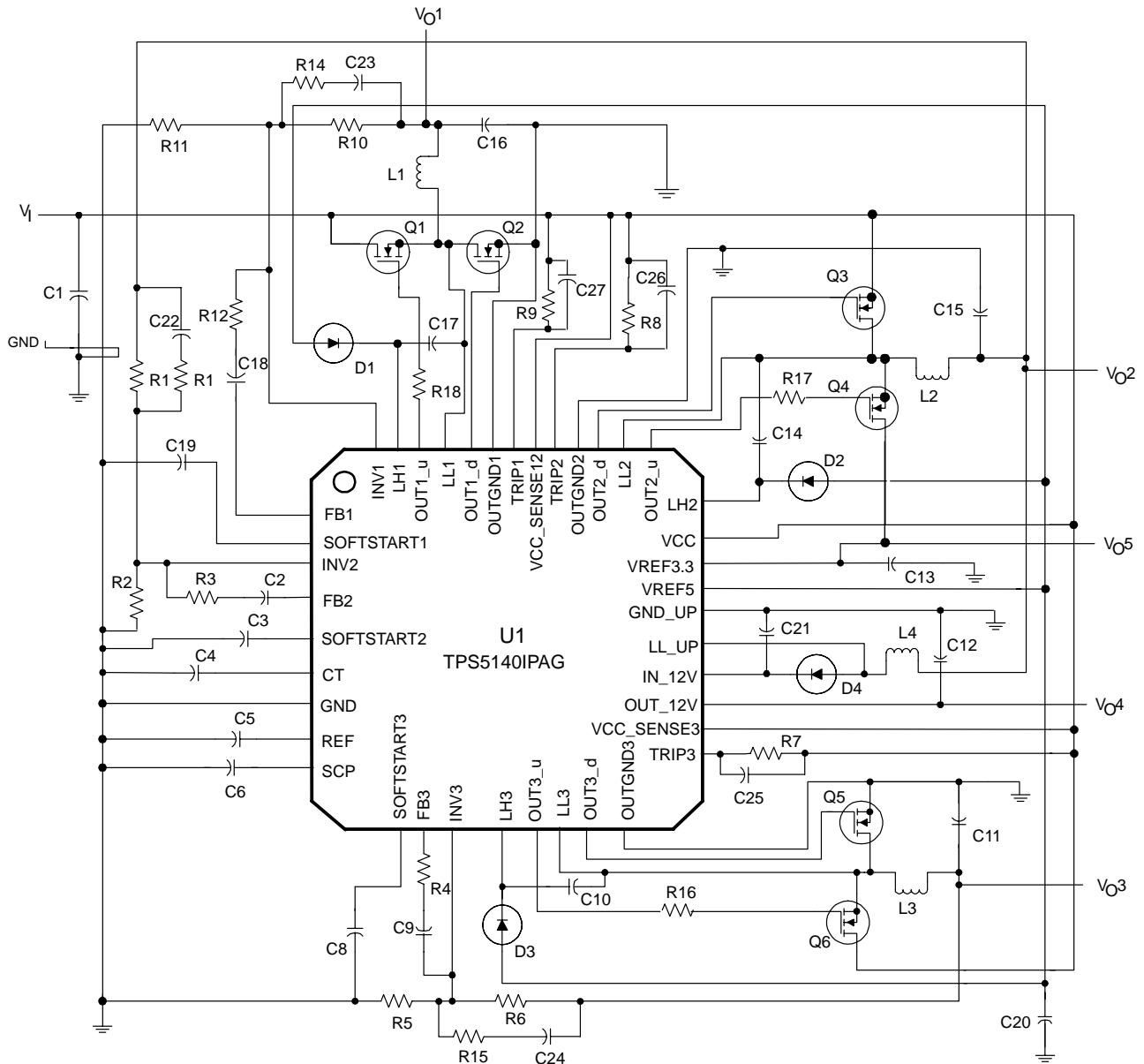

AVAILABLE OPTIONS

T _A	PACKAGE	
	PAG	EVM
-20°C to 85°C	TQFP64 (PAG)	



POST OFFICE BOX 655303 • DALLAS, TEXAS 75265

TPS5140

FOUR-CHANNEL DC/DC CONTROLLER FOR NOTEBOOK PC POWER

SLVS305A – DECEMBER 2000 – REVISED JANUARY 2001

functional block diagram—whole block

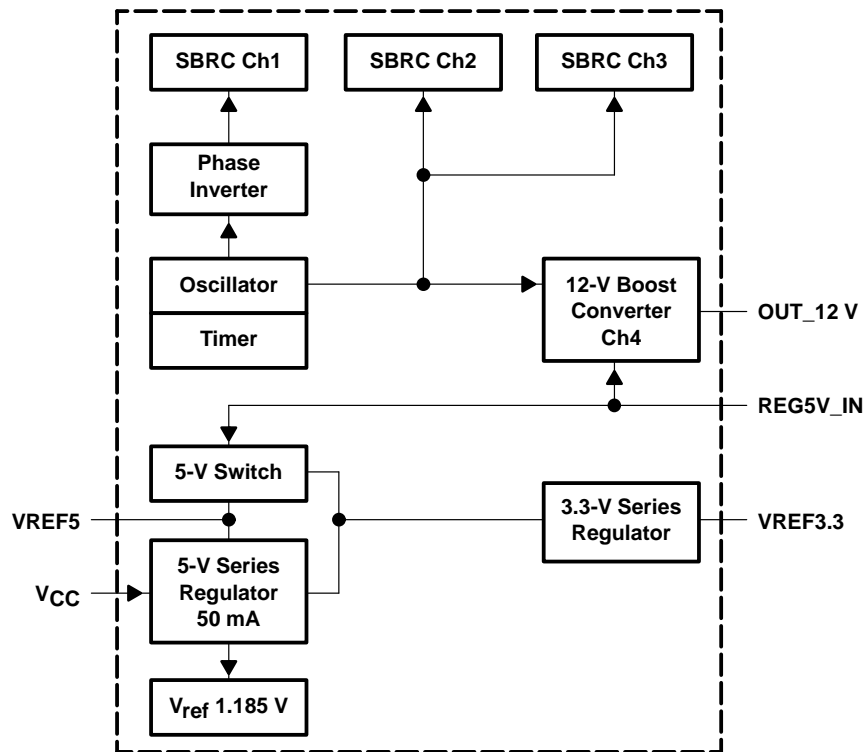

TPS5140 FOUR-CHANNEL DC/DC CONTROLLER FOR NOTEBOOK PC POWER

SLVS305A – DECEMBER 2000 – REVISED JANUARY 2001

functional block diagram—SMPS block

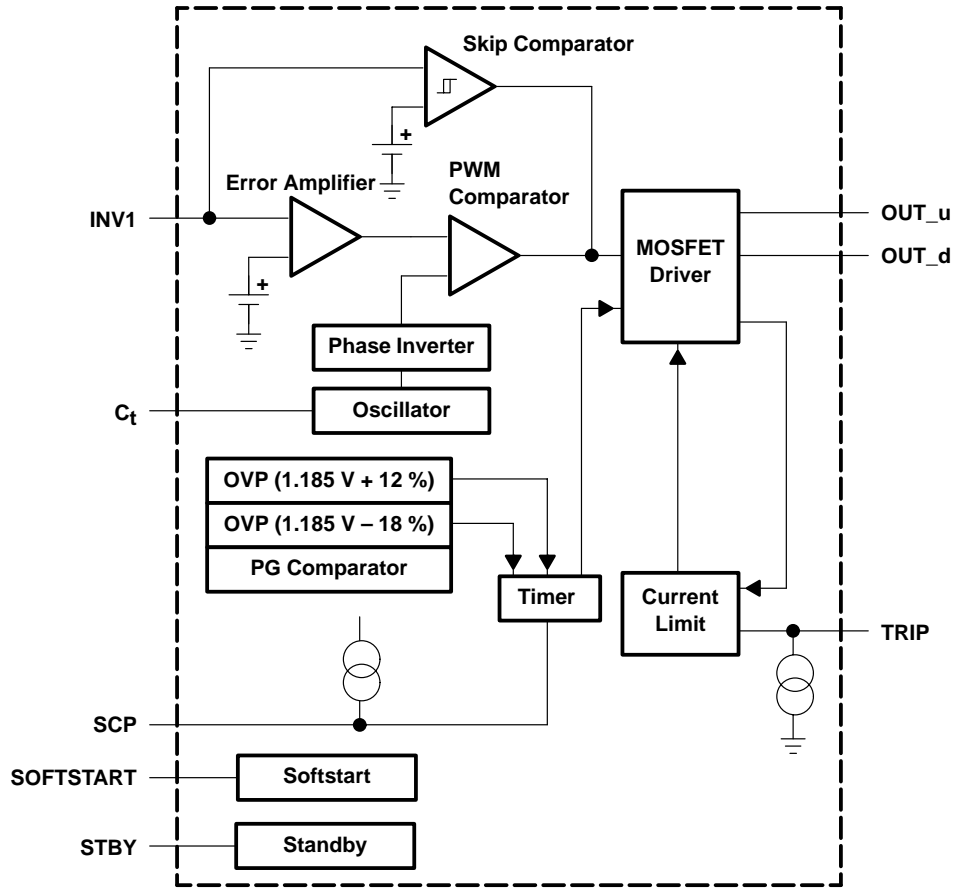

TPS5140 FOUR-CHANNEL DC/DC CONTROLLER FOR NOTEBOOK PC POWER

SLVS305A – DECEMBER 2000 – REVISED JANUARY 2001

functional block diagram—boost 12-V block

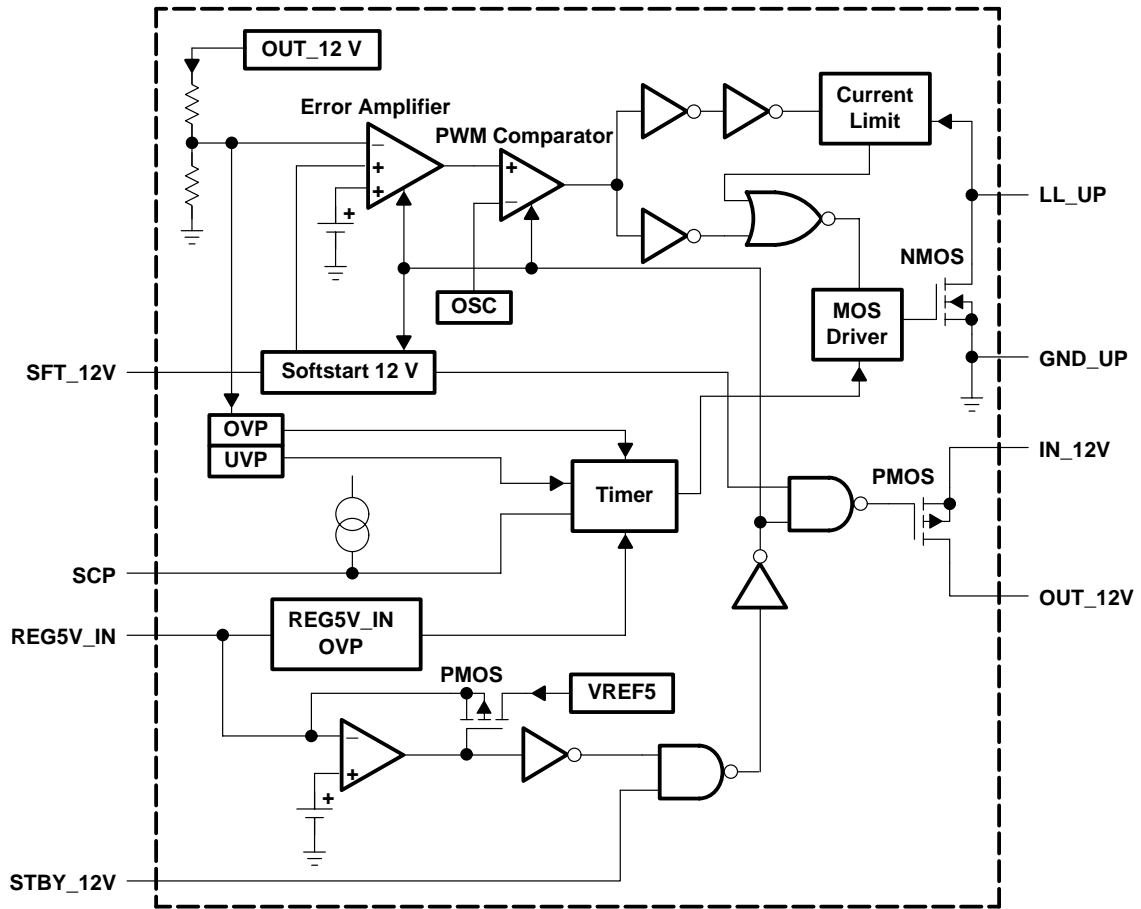

TPS5140 FOUR-CHANNEL DC/DC CONTROLLER FOR NOTEBOOK PC POWER

SLVS305A – DECEMBER 2000 – REVISED JANUARY 2001

functional block diagram—power good block

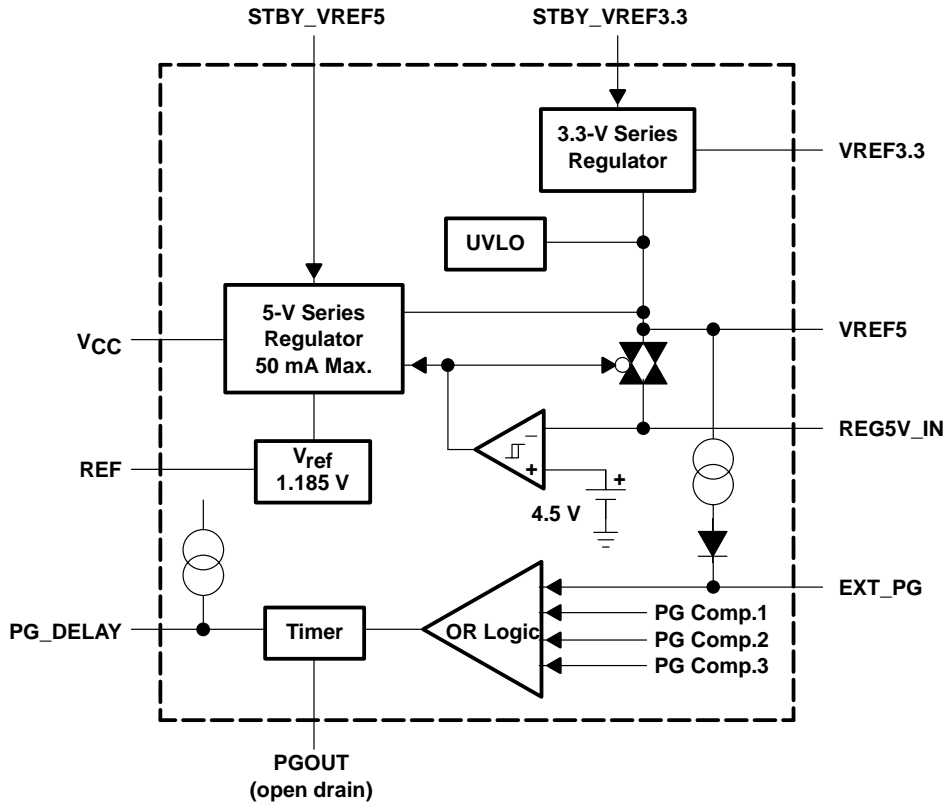

TPS5140

FOUR-CHANNEL DC/DC CONTROLLER FOR NOTEBOOK PC POWER

SLVS305A – DECEMBER 2000 – REVISED JANUARY 2001

Terminal Functions

TERMINAL NAME	NO.	I/O	DESCRIPTION
C _t	8	I/O	External capacitor from C _t to GND used for adjusting the triangle oscillator.
EXT_PG	21	I	External power good signal input
FB1	1	O	Feedback output of CH1 error amplifier
FB2	5	O	Feedback output of CH2 error amplifier
FB3	25	O	Feedback output of CH3 error amplifier
GND	9		Control GND
GND_UP	40		Ground for 12-V boost converter
INV1	64	I	Inverting input of CH1 error amplifier, skip comparator and OVP1/UVP1, PG comparator
INV2	4	I	Inverting input of CH1 error amplifier, skip comparator and OVP2/UVP2, PG comparator
INV3	26	I	Inverting input of CH1 error amplifier, skip comparator and OVP3/UVP3, PG comparator
IN_12V	38	I	Input of PMOS switch for 12-V boost output. Connecting to cathode of the external Schottky diode.
LH1	61	I/O	Bootstrap capacitor connection for CH1 high side gate drive
LH2	48	I/O	Bootstrap capacitor connection for CH2 high side gate drive
LH3	28	I/O	Bootstrap capacitor connection for CH3 high side gate drive
LL1	59	I/O	Bootstrap low for CH1 high side gate driving return and output current protection. Connect to the junction of the high side and low side FETs for floating drive configuration.
LL2	50	I/O	Bootstrap low for CH2 high side gate driving return and output current protection. Connect to the junction of the high side and low side FETs for floating drive configuration.
LL3	30	I/O	Bootstrap low for CH3 high side gate driving return and output current protection. Connect to the junction of the high side and low side FETs for floating drive configuration.
LL_UP	39	I/O	Open drain output of internal NMOS switch for 12-V boost converter. Connect between external inductor and the anode of the schottky diode.
NC	3,20,27,33, 36,41,45,47 58,62,63		No connect
OUT1_d	57	O	Gate drive output for CH1 low side gate drive
OUT2_d	51	O	Gate drive output for CH2 low side gate drive
OUT3_d	31	O	Gate drive output for CH3 low side gate drive
OUT1_u	60	O	Gate drive output for CH1 high side switching FETs
OUT2_u	49	O	Gate drive output for CH2 high side switching FETs
OUT3_u	29	O	Gate drive output for CH3 high side switching FETs
OUT_12V	37	O	Output of PMOS switch for 12-V boost output. Connect to the output capacitor for 12-V boost output.
OUTGND1	56		Ground for CH1 FETs drivers. It is connected to one of the current limiting comparator input.
OUTGND2	52		Ground for CH2 FETs drivers. It is connected to one of current limiting comparator input.
OUTGND3	32		Ground for CH3 FETs drivers. It is connected to the one of current limiting comparator input.
PGOUT	18	O	Open drain output for power good signal
PG_DELAY	19	I/O	Programmable delay for power good. Connect to the external capacitor for timer delay.
PHASE_12V	23	I	Phase compensation for the 12-V boost converter. Connect to an external capacitor. But normally it is not connected.
PWM_SEL	7	I	PWM or auto PWM/SKIP modes select L: PWM fixed H: auto PWM/SKIP
REF	10	O	1.185 V reference voltage output



TPS5140

FOUR-CHANNEL DC/DC CONTROLLER FOR NOTEBOOK PC POWER

SLVS305A – DECEMBER 2000 – REVISED JANUARY 2001

Terminal Functions(Continued)

TERMINAL NAME	NO.	I/O	DESCRIPTION
REG5V_IN	42	I	External 5 V input
SCP	17	I/O	Short circuit protection terminal. An external capacitor is connected between SCP and GND to set the SCP enable time up.
SOFTSTART1	2	I/O	External capacitor from SOFTSTART1 to GND for CH1 soft starts control.
SOFTSTART2	6	I/O	External capacitor from SOFTSTART2 to GND for CH2 soft starts control.
SOFTSTART3	24	I/O	External capacitor from SOFTSTART3 to GND for CH3 soft starts control.
SOFTSTART_12V	22	I/O	External capacitor from SOFTSTART_12V to GND for CH4 (12-V boost converter) soft starts control.
STBY1	13	I	Stand by control for CH1
STBY2	14	I	Stand by control for CH2
STBY3	16	I	Stand by control for CH3
STBY12V	15	I	Stand by control for 12-V boost converter
STBY_VREF3.3	11	I	Stand by control for 3.3-V linear regulator
STBY_VREF5	12	I	Stand by control for 5-V linear regulator
TRIP1	55	I	External resistor connection for CH1 output current protection control
TRIP2	53	I	External resistor connection for CH2 output current protection control
TRIP3	34	I	External resistor connection for CH3 output current protection control
VCC	46		Supply voltage input
VCC_SENSE12	54	I	Supply voltage input and input voltage terminal for CH1/2 output current sense
VCC_SENSE3	35	I	Supply voltage input and input voltage terminal for CH3 output current sense
VREF3.3	44	O	3.3-V linear regulator output
VREF5	43	O	5-V linear regulator output

detailed description

REF (1.185 V)

The reference voltage is used for setting the output voltage and voltage protection. This reference voltage is dropped down from the 5-V regulator. The tolerance is 1.5 % over the entire temperature range.

CH1, 2, 3 (synchronous buck controller)

The TPS5140 includes three synchronous buck controllers. CH2 and CH3 (5 V and 2.5 V) are operated in phase, but CH1 (3.3 V) is operated 180° out of phase from CH2 and CH3, but at the same frequency. All channels have separate standby and softstart control.

12-V boost converter

OUT_12V is a 12-V boost converter output . It can isolate V_I (5 V) and V_O fully.

5-V regulator

An internal linear voltage regulator is used for the high-side driver bootstrap voltage and as the source of V_{ref} . When the 5-V regulator is disconnected from the MOSFET drivers, it is used only for the source of V_{ref} . Since the input voltage is from 4.5 V to 28 V, this feature offers a fixed bootstrap voltage to simplify the drive design. The 5-V regulator is also used for powering the low side driver. The 5-V regulator is active if STBY_VREF5 is high and has a tolerance of 4%.



detailed description (continued)

3.3-V regulator

TPS5140 has a 3.3-V linear regulator. The output is made from the internal 5 V regulator or external 5 V from REG5V_IN. The 3.3-V regulator has an output current limit. The maximum output current is 30 mA.

5-V switch

If the internal 5-V switch senses a 5-V input from the REG5V_IN terminal, the internal 5-V linear regulator will be disconnected from the MOSFET drivers. The external 5 V will be used for both the low-side driver and the high-side bootstrap, thus increasing the efficiency.

auto PWM/SKIP

The PWM_SEL terminal selects either the auto PWM/SKIP or fixed PWM mode. If this terminal is lower than 0.5 V, the outputs operate in the fixed PWM mode. If 2.5 V (minimum) is applied, the outputs operate in auto PWM/SKIP mode. In the auto PWM/SKIP mode, the operation changes from the PWM mode to the SKIP mode automatically under light load conditions. Avoid using a MOSFET with very low $r_{DS(on)}$ if the auto SKIP function is implemented.

error amp

All three synchronous buck channels have their own error amplifier to regulate the output. The error amplifier is used in the PWM mode for high output current conditions (> 0.2 A). Voltage mode control is implemented.

skip comparator

In skip mode, all three synchronous buck channels have their own hysteresis comparator to regulate the output voltages. The hysteresis voltage is set internally and typically at 8.5 mV. The delay from the comparator input to the driver output is typically 1.2 μ s.

low-side driver

The low-side driver is designed to drive low- $r_{DS(on)}$ n-channel MOSFETs. The maximum drive voltage is 5 V from VREF5. Ch1, 2, and 3 MOSFET driver capability is 1.5 A, source and sink.

high-side driver

The high-side driver is designed to drive low- $r_{DS(on)}$ n-channel MOSFETs. CH1 and CH2 MOSFET drivers have 1.2 A capability, source and sink. When configured as a floating driver, the bias voltage to the driver is developed from VREF5, limiting the maximum drive voltage between OUT_u and LL to 5 V. The maximum voltage that can be applied between LHx and OUTGND is 33 V.

dead time

Dead time prevents shoot-through current from flowing through the main power MOSFETs during switching transitions by actively controlling the turnon time of the MOSFETs drivers.

current protection

Current protection is achieved by sensing the drain-to-source voltage drop of the low-side power MOSFET during the low-side MOSFET's on time at OUTGND and LL. An external resistor between V_{CC}_SENSE and TRIP terminal in series with the internal current source adjusts the current limit. When the voltage drop during the low-side MOSFET on-time is high enough, the current comparator triggers the current protection and the MOSFET drivers are turned off. After a programmable time delay, the SCP circuit latches off all MOSFET drivers. The internal current source tolerance is $\pm 10\%$. CH2 monitors both high-side and low-side MOSFET voltage drops.

TPS5140

FOUR-CHANNEL DC/DC CONTROLLER FOR NOTEBOOK PC POWER

SLVS305A – DECEMBER 2000 – REVISED JANUARY 2001

detailed description (continued)

OVP

For over voltage protection, the TPS5140 monitors INV terminal voltage. When the INV voltage becomes higher than 1.185 V (+12%), the OVP comparator output becomes high and the SCP timer starts to charge the SCP capacitor. After a programmable time delay, the SCP circuit forces CH1, 2, 3 high-side MOSFET drivers to latch off and the low-side MOSFET drivers to latch on.

UVP

For under voltage protection, the TPS5140 monitors INV terminal voltage. When the INV voltage becomes lower than 1.185 V (–18 %), the UVP comparator output becomes high and the SCP timer starts to charge the SCP capacitor. Also, when the current comparator of CH1, 2, 3 triggers the OCP, the UVP comparator detects the under voltage output and the SCP capacitor starts to charge. After the programmable time delay, the SCP circuit forces the CH1, 2, 3 MOSFET drivers to latch off.

SCP

When an OVP or UVP comparator output becomes high, the SCP circuit starts to charge the SCP capacitor. The charging source current value is different between OVP alert and UVP alert.

$$\text{SCP source current (OVP)} = \text{SCP source current (UVP)} \times 5$$

The threshold voltage of SCP comparator is 1.185 V.

power good

The power good output reports the output fail condition. PG comparators monitor an under voltage or over voltage of CH1, 2, 3, with a threshold of –7 % and 7 %. TPS5140 has an EXT_PG terminal, which can be used for the input of an external PG signal. Delay time is programmable by charging an external capacitor on the PG_DELAY terminal.

SOFTSTART1, 2, 3

Separate soft start terminals make it possible to customize the start-up time of each output. The voltage on the charging softstart capacitor gradually raises, limiting the surge current and voltage. A soft start is initiated when the STBY terminals are switched.

STBY1, 2, 3, 12V

CH1, 2, 3 and 12V can be switched into standby mode separately by grounding the STBY terminal.

STBY_VREF3.3, 5V

STBY_VREF3.3 shuts down the 3.3-V regulator by grounding the STBY_VREF3.3 terminal. When STBY_VREF5 is high, only the 5-V regulator is operating.

UVLO

When the input voltage exceeds 4 V, the IC is turned on and is ready to function. When the input voltage is lower than the turn on value, the IC is turned off. The typical hysteresis voltage is 40 mV.

phase inverter

The phase inverter controls the phase of CH1 and CH2, 3. CH2, 3 operate in the same phase as OSC. CH1 operates 180° out of phase from OSC. Out-of-phase operation enables a smaller input capacitor.

OVP (12-V boost converter)

The TPS5140 monitors over voltage of the 12-V boost converter. When an output over voltage is detected, the timer starts to charge an external capacitor that is connected to the SCP terminal. After a programmable time delay, the SCP circuit forces all (CH1, 2, 3 and 12 V) MOSFET drivers to latch-off.



detailed description (continued)

UVP (12-V boost converter)

TPS5140 monitors output under voltage of the 12-V boost converter. When an output under voltage is detected, the timer starts to charge an external capacitor that is connected to the SCP terminal. After a programmable time delay, the SCP circuit forces all (CH1, 2, 3, and 12 V) MOSFETs drivers to latch off.

SOFTSTART_12V

An internal capacitor exists for 12-V soft start. If the soft start time needs to be extended, an external capacitor should be connected to this terminal. The 12-V boost converter must start when REG5V_IN terminal is over 4.5 V.

current limit of 12-V boost converter

The 12-V boost current limit monitors the current flowing through the internal MOSFET. When the voltage drop across the internal N-channel MOSFET is high enough during its on time, the current limit circuit forces the internal N-channel MOSFET to turn off.

PHASE_12V

The 12-V boost converter does not typically require phase compensation. If there is reason to change the phase, the 12-V boost converter can be phase compensated by inserting external resistors and capacitors to GND. Otherwise, the PHASE_12V terminal should be left open.

logic charts

Table 1. Logic Chart1

STBY1	STBY2	STBY3	CH1	CH2	CH3	PGOUT
L	L	L	Disable	Disable	Disable	N/A
L	L	H	Disable	Disable	Enable	Active [†]
L	H	L	Disable	Enable	Disable	Active [†]
L	H	H	Disable	Enable	Enable	Active [†]
H	L	L	Enable	Disable	Disable	Active [†]
H	L	H	Enable	Disable	Enable	Active [†]
H	H	L	Enable	Enable	Disable	Active [†]
H	H	H	Enable	Enable	Enable	Active [†]

[†] During softstart, PGOUT is active low.

Table 2. Logic Chart2

STBY_VREF5	STBY_VREF3.3	VREF5 [‡]	VREF3.3
L	L	N/A	Disable
H	L	Enable	Disable
L	H	Enable	Enable
H	H	Enable	Enable

[‡] To disable VREF5, all STBY1, 2, 3, STBY_VREF3.3 and STBY_VREF5 must be L.

Table 3. Logic Chart3

STBY12V	REG5V_IN	12 VOUT
L	L	Disable
L	H	Disable
H	L	Disable
H	H	Enable

TPS5140 FOUR-CHANNEL DC/DC CONTROLLER FOR NOTEBOOK PC POWER

SLVS305A – DECEMBER 2000 – REVISED JANUARY 2001

PGOUT timing chart

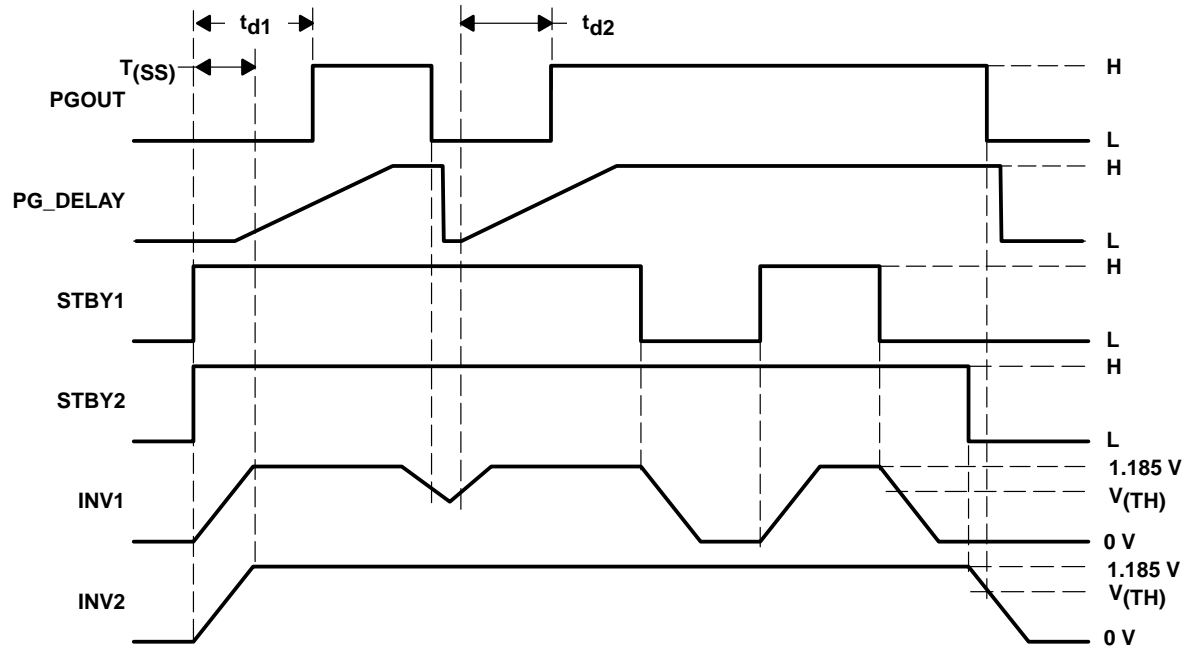

POST OFFICE BOX 655303 • DALLAS, TEXAS 75265

TPS5140

FOUR-CHANNEL DC/DC CONTROLLER FOR NOTEBOOK PC POWER

SLVS305A – DECEMBER 2000 – REVISED JANUARY 2001

absolute maximum ratings over operating free-air temperature (unless otherwise noted)†

Supply voltage, V_{CC} (see Note 1)	–0.3 V to 30 V
Input voltage; INV1/2/3, CT, PWM_SEL, REG5V_IN, SOFTSTART1/2/3, SOFTSTART_12V	–0.3 V to 7 V
SCP, PG_DELAY, PHASE_12V, OUT1/2/3_d, VREF3.3/5, FB1/2/3	–0.3 V to 7 V
PGOUT, EXT_PG	–0.3 V to 7 V
STBY1/2/3/12V, STBY_VREF3.3/5, TRIP1/2/3	–0.3 V to 30 V
VCC_SENSE12/3, LL1/2/3	–0.3 V to 30 V
LL_UP, OUT_12V, IN_12V	–0.3 V to 16 V
LH1/2/3, OUT1/2/3_u	–0.3 V to 35 V
REF	–0.3 V to 3 V
Operating free-air temperature range, T_A (see Note 3)	–20°C to 85°C
Storage temperature range, T_{stg}	–55°C to 155°C

† Stresses beyond those listed under “absolute maximum ratings” may cause permanent damage to the device. These are stress ratings only, and functional operation of the device at these or any other conditions beyond those indicated under “recommended operating conditions” is not implied. Exposure to absolute-maximum-rated conditions for extended periods may affect device reliability.

- NOTES:
- All voltage values are with respect to the network ground terminal.
 - This rating is specified at duty = 10% on output rise and fall each pulse. Each pulse width (rise and fall) for the peak current should not exceed 2 μ s.
 - See Dissipation Rating Table for free-air temperature range above 25°C.

DISSIPATION RATING TABLE

PACKAGE	$T_A \leq 25^\circ\text{C}$ POWER DISSIPATION	DERATING FACTOR ABOVE $T_A = 25^\circ\text{C}$	$T_A = 85^\circ\text{C}$ POWER DISSIPATION
PAG	1811 mW	14.49 mW/°C	941.6 mW

recommended operating conditions

	MIN	NOM	MAX	UNIT	
Supply voltage, V_{CC}	4.5		28	V	
Input voltage, V_i	INV1/2/3, CT, PG_DELAY, PWM_SEL SOFTSTART1/2/3 SOFT-START_12V, SCP PHASE_12V, PGOUT, EXT_PG,		6	V	
	REG5V_IN		–0.1		5.5
	STBY1/2/3/12V STBY_VREF3.3/5, TRIP1/2/3, $V_{CC_SENSE12/3}$		–0.1		28
	OUT1/2/3_u, LH1/2/3		–0.1		33
	LL_UP, OUT_12V, IN_12V		–0.1	15	
Oscillator frequency, f_{osc}	CT capacitance‡		44	pF	
Operation temperature range, T_A	–20		85	°C	

‡ The recommended maximum operating frequency is typically 300 kHz.

electrical characteristics over recommended operating free-air temperature range, $V_{CC} = 7$ V (unless otherwise noted)

reference voltage

PARAMETER	TEST CONDITIONS	MIN	TYP	MAX	UNIT
V_{ref} Reference voltage			1.185		V
$V_{ref(tol)}$ Reference voltage tolerance	$T_A = 25^\circ\text{C}$, $I_{(vref)} = 50 \mu\text{A}$	–1%		1%	
	$I_{(vref)} = 50 \mu\text{A}$	–1.5%		1.5%	
Line regulation	$V_{CC} = 4.5$ V to 28 V, $I_{(vref)} = 50 \mu\text{A}$		0.05	3	mV
Load regulation	$I_{(vref)} = 0.1 \mu\text{A}$ to 1 mA		0.15	5	mV



TPS5140

FOUR-CHANNEL DC/DC CONTROLLER FOR NOTEBOOK PC POWER

SLVS305A – DECEMBER 2000 – REVISED JANUARY 2001

electrical characteristics over recommended operating free-air temperature range, $V_{CC} = 7\text{ V}$ (unless otherwise noted) (continued)

oscillator

PARAMETER		TEST CONDITIONS	MIN	TYP	MAX	UNIT
f_{osc}	Frequency	PWM mode, $C_T = 56\text{ pF}$, $T_A = 25^\circ\text{C}$		250		kHz
$V_{OS(CH)}$	High-level output voltage	DC	1	1.1	1.2	V
		$f_{osc} = 250\text{ kHz}$		1.17		
$V_{OS(CL)}$	Low-level output voltage	DC	0.4	0.5	0.6	V
		$f_{osc} = 250\text{ kHz}$		0.43		

error amplifier

PARAMETER		TEST CONDITIONS	MIN	TYP	MAX	UNIT
V_{IO}	Input offset voltage	$T_A = 25^\circ\text{C}$		2	10	mV
$A(V)$	Open-loop voltage gain			90		dB
$G(B)$	Unity-gain bandwidth			2.5		MHz
$I_{(snk)}$	Output sink current	$V_O = 1\text{ V}$	0.3	0.7		mA
$I_{(src)}$	Output source current		0.4	0.9		

duty control

PARAMETER		TEST CONDITIONS	MIN	TYP	MAX	UNIT
Maximum duty cycle		CH1/3, $f_{osc} = 250\text{ kHz}$	75%			
		CH2, $f_{osc} = 250\text{ kHz}$	85%			
		12V boost, $f_{osc} = 250\text{ kHz}$		70%		

control

PARAMETER		TEST CONDITIONS	MIN	TYP	MAX	UNIT
V_{IH}	High-level input voltage	STBY1/2/3/12V, EXT_PGPWM_SEL, STBY_VREF5/3.3	2			V
V_{IL}	Low-level input voltage	STBY1/2/3/12V, EXT_PGPWM_SEL, STBY_VREF5/3.3			0.3	V

5-V internal switch

PARAMETER		TEST CONDITIONS	MIN	TYP	MAX	UNIT
$V_{(TLH)}$	Threshold voltage	High	REG5V_IN		4.8	V
$V_{(THL)}$		Low	REG5V_IN		4.7	
V_{hys}	Hysteresis			30	200	mV

VREF5

PARAMETER		TEST CONDITIONS	MIN	TYP	MAX	UNIT
V_O	Output voltage	$I_O = 0\text{ mA to }50\text{ mA}$, $V_{CC} = 5.5\text{ V to }28\text{ V}$, $T_A = 25^\circ\text{C}$	4.8		5.2	V
	Line regulation	$V_{CC} = 5.5\text{ V to }28\text{ V}$, $I_O = 10\text{ mA}$			20	mV
	Load regulation	$I_O = 1\text{ mA to }10\text{ mA}$, $V_{CC} = 5.5\text{ V}$			40	mV
I_{OS}	Short circuit output current	$V_{ref} = 0\text{ V}$, $T_A = 25^\circ\text{C}$	65			mA
$V_{(TLH)}$	UVLO threshold voltage	High	VREF5 voltage		4.2	V
$V_{(THL)}$		Low			4.1	
V_{hys}	Hysteresis	VREF5 voltage	30		200	mV



TPS5140

FOUR-CHANNEL DC/DC CONTROLLER FOR NOTEBOOK PC POWER

SLVS305A – DECEMBER 2000 – REVISED JANUARY 2001

electrical characteristics over recommended operating free-air temperature range, $V_{CC} = 7\text{ V}$ (unless otherwise noted) (continued)

VREF3.3

PARAMETER		TEST CONDITIONS	MIN	TYP	MAX	UNIT
V_O	Output voltage	$I_O = 0\text{ mA to }30\text{ mA}$, $V_{CC} = 5.5\text{ V to }28\text{ V}$, $T_A = 25^\circ\text{C}$	3.15	3.30	3.45	V
	Line regulation	$V_{CC} = 5.5\text{ V to }28\text{ V}$, $I_O = 10\text{ mA}$			20	mV
	Load regulation	$I_O = 1\text{ mA to }10\text{ mA}$, $V_{CC} = 5.5\text{ V}$			40	mV
I_{OS}	Short circuit output current	$V_{ref} = 0\text{ V}$, $T_A = 25^\circ\text{C}$	-40			mA

output

PARAMETER		TEST CONDITIONS	MIN	TYP	MAX	UNIT
OUT_u	Sink current	$V_O = 3\text{ V}$		1.2		A
	Source current	$V_O = 2\text{ V}$		-1.2		
OUT_d	Sink current	$V_O = 3\text{ V}$		1.5		A
	Source current	$V_O = 2\text{ V}$		-1.5		
LL_UP	Sink current	$V_{LL_UP} = 0.3\text{ V}$, $OUT_{12V} = 12\text{ V}$		0.65		A
OUT_12V	Output impedance	$IN_{12V} = 12\text{ V}$, $I_{OUT_12V} = 150\text{ mA}$		1.1		Ω
$I_{(TRIP)}$	TRIP current	TRIP1/2/3, $T_A = 25^\circ\text{C}$	11.5	13	15	μA

softstart

PARAMETER		TEST CONDITIONS	MIN	TYP	MAX	UNIT
$I_{(CTRL)}$	Soft start current	Softstart1/2/3	-1.6	-2.3	-2.9	μA
		Softstart_12V		-0.007		

output voltage monitor

PARAMETER		TEST CONDITIONS	MIN	TYP	MAX	UNIT
OVP comparator threshold voltage		CH1/2/3	1.28	1.33	1.38	V
		12 V boost	12.9	13.4	13.9	
UVP comparator threshold voltage		CH1/2/3	0.90	0.95	1	V
		12 V boost	9	9.5	10	
PG comparator threshold voltage		PG comparator1/2/3, upper threshold	1.22	1.27	1.32	V
		PG comparator1/2/3, lower threshold	1.05	1.1	1.15	
PG propagation delay from INV to PG_OUT		INV = 0.985 V to 1.185 V, PG_DELAY = open		3.7		μs
		INV = 1.185 V to 0.985 V, PG_DELAY = open		8.9		
$I_{(PG_DELAY)}$	PG_DELAY source current		1.1	1.7	2.3	μA
$I_{(SCP)}$	SCP source current	UVP protection	1.5	2.3	3.1	μA
		OVP protection	8	11.5	15	

whole device

PARAMETER		TEST CONDITIONS	MIN	TYP	MAX	UNIT
I_{CC}	Supply current			1.8	2.6	mA
$I_{O(SD)}$	Shutdown current	STBY1/2/3/12V, $STBY_VREF5/3.3 = 0\text{ V}$		0.001	10	μA



TPS5140 FOUR-CHANNEL DC/DC CONTROLLER FOR NOTEBOOK PC POWER

SLVS305A – DECEMBER 2000 – REVISED JANUARY 2001

TYPICAL CHARACTERISTICS

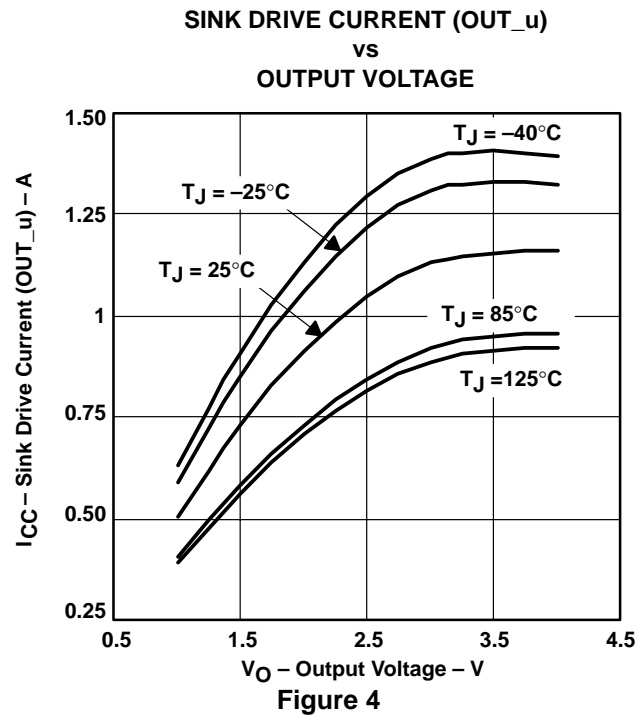
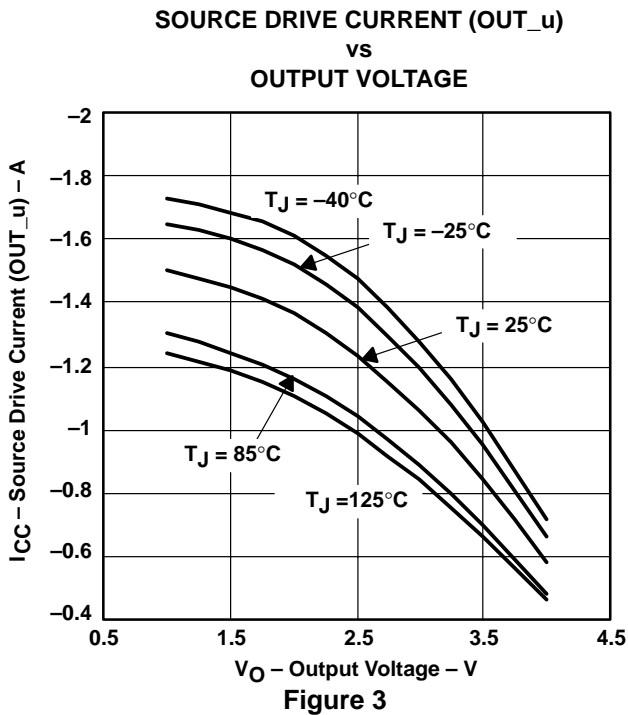
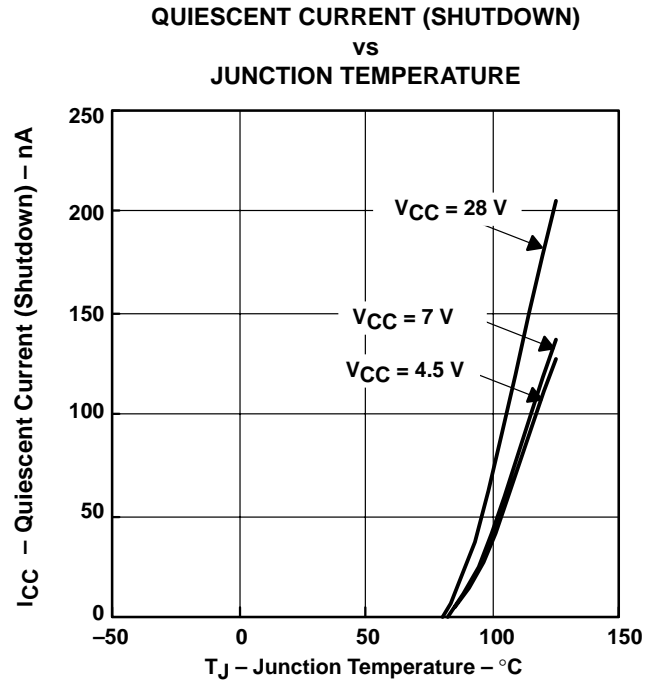
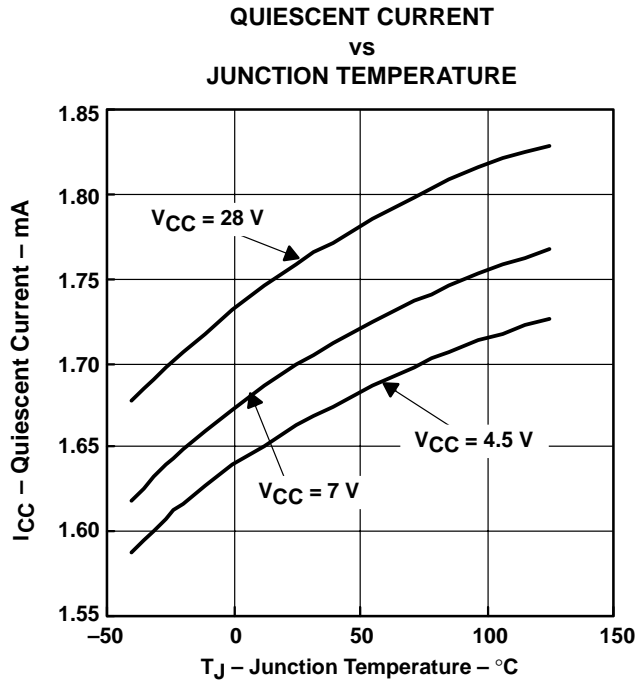

TYPICAL CHARACTERISTICS

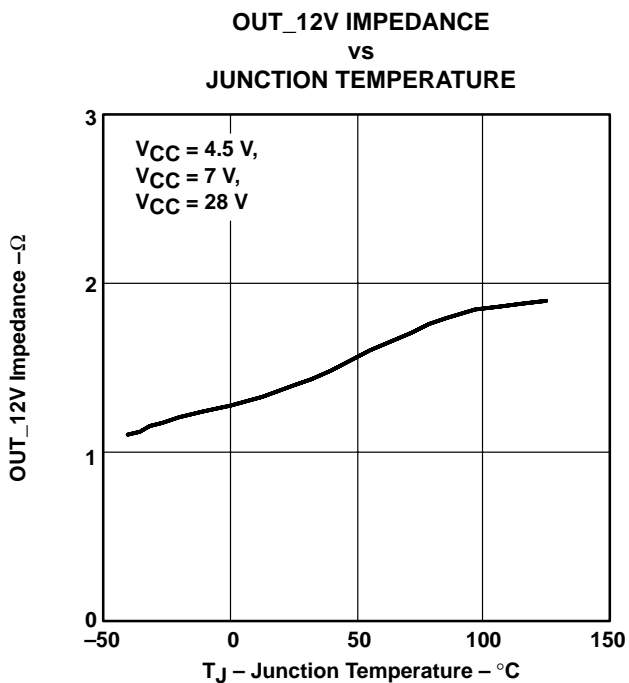
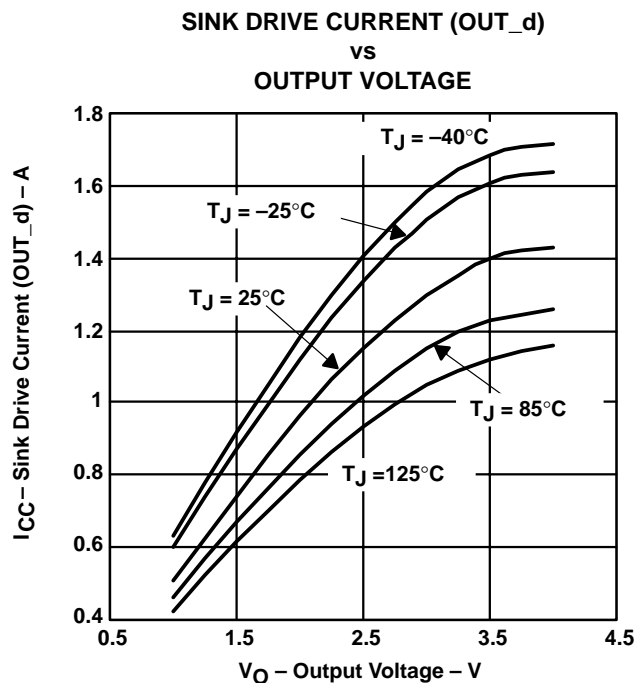
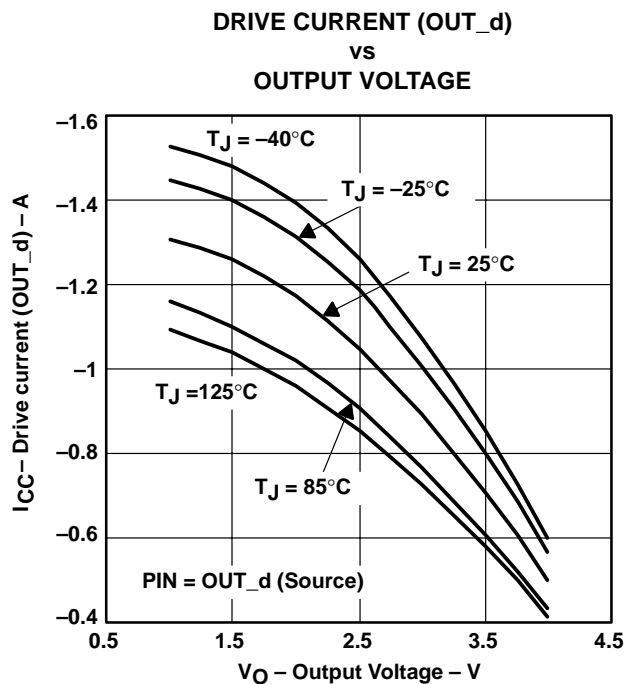

TPS5140 FOUR-CHANNEL DC/DC CONTROLLER FOR NOTEBOOK PC POWER

SLVS305A – DECEMBER 2000 – REVISED JANUARY 2001

TYPICAL CHARACTERISTICS

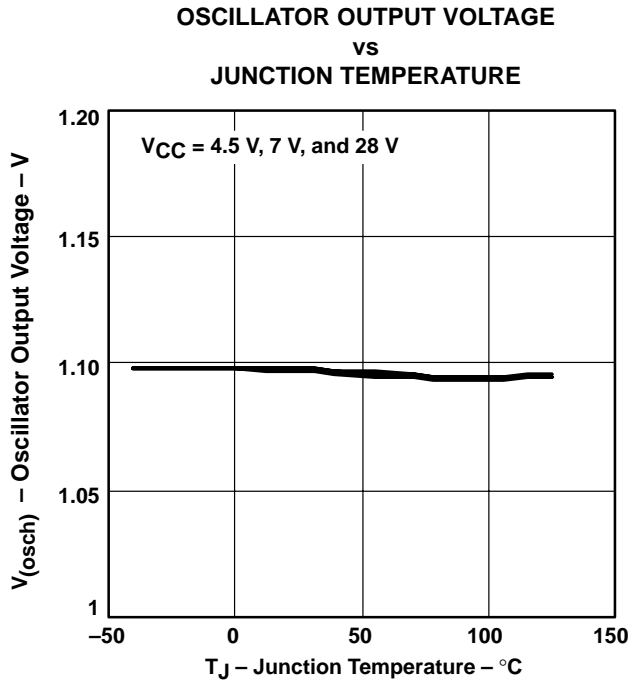

Figure 8

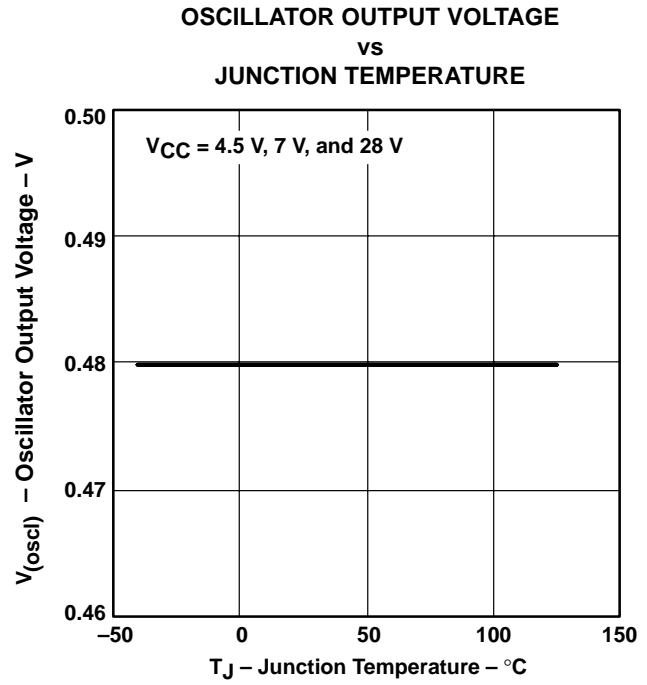

Figure 9

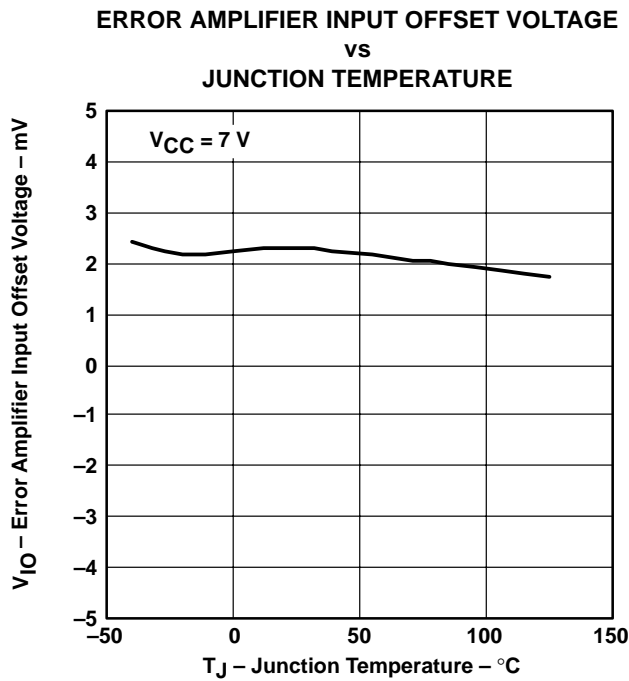

Figure 10

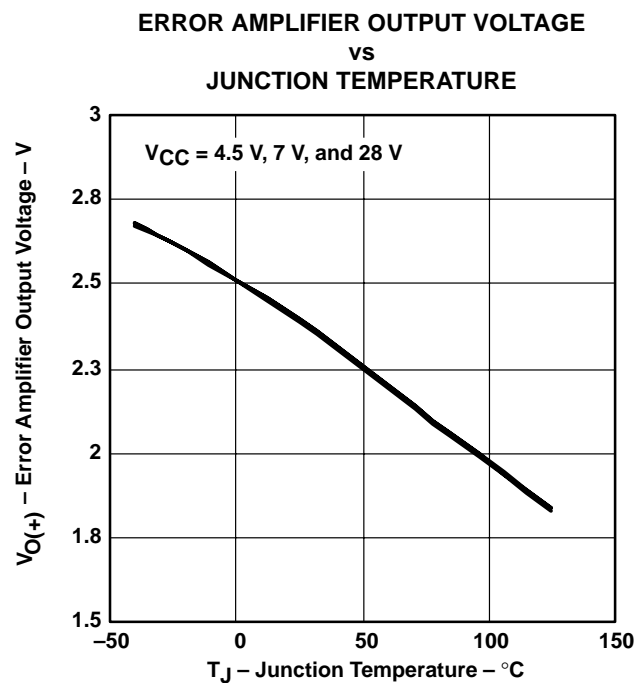

Figure 11

TYPICAL CHARACTERISTICS

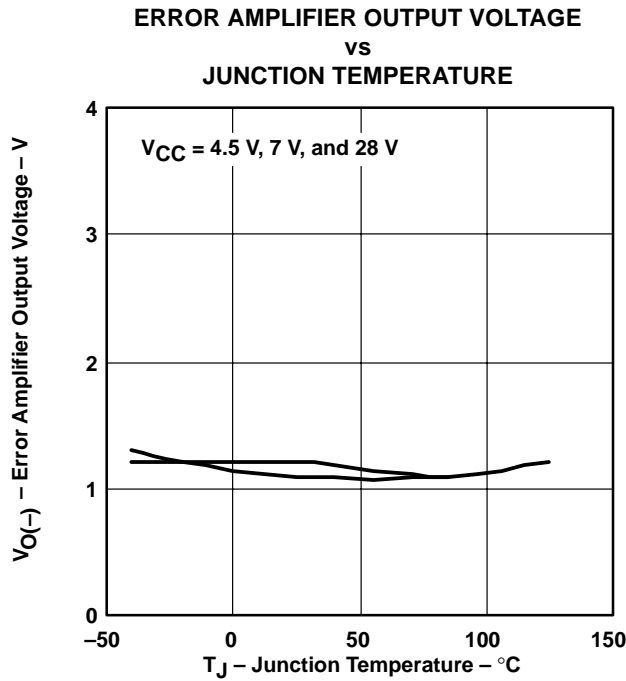

Figure 12

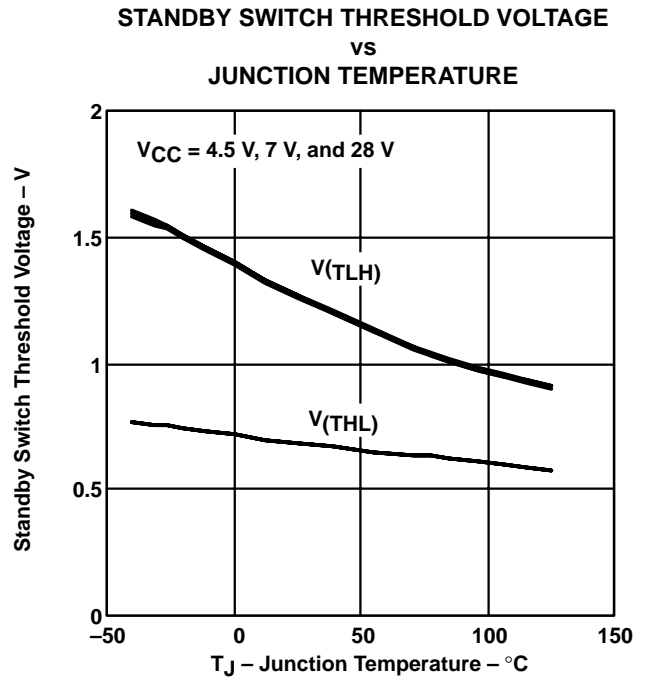

Figure 13

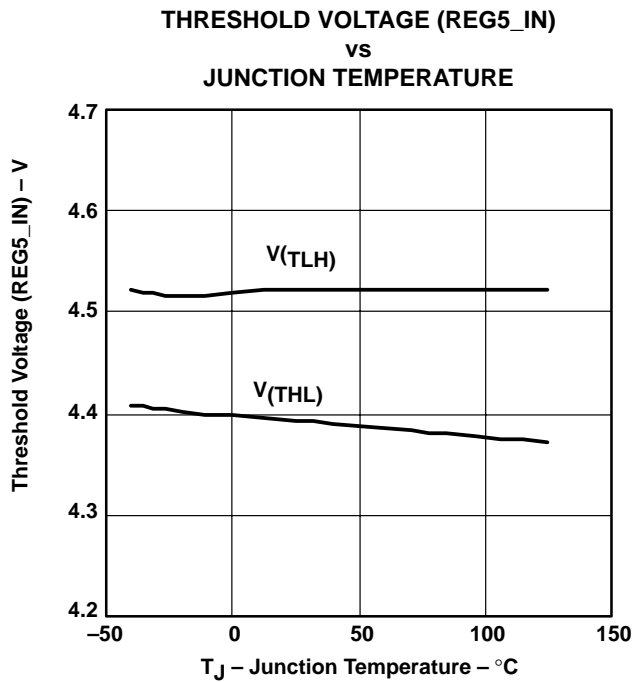

Figure 14

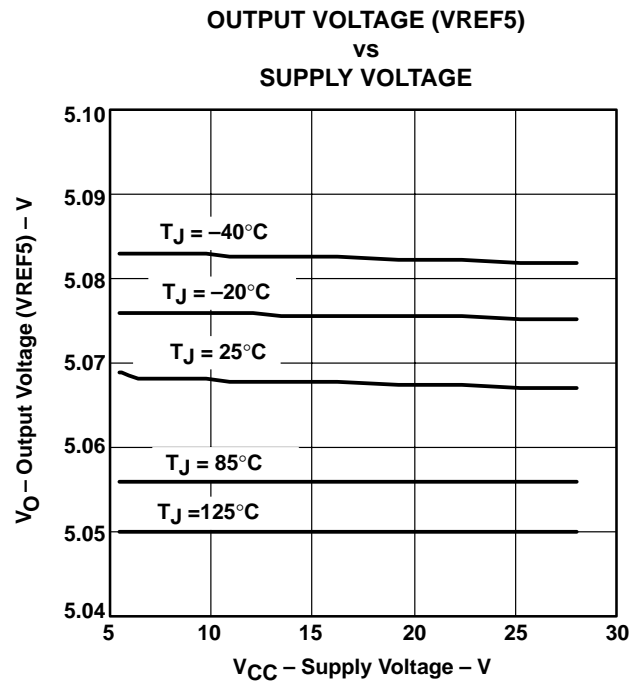

Figure 15

TPS5140 FOUR-CHANNEL DC/DC CONTROLLER FOR NOTEBOOK PC POWER

SLVS305A – DECEMBER 2000 – REVISED JANUARY 2001

TYPICAL CHARACTERISTICS

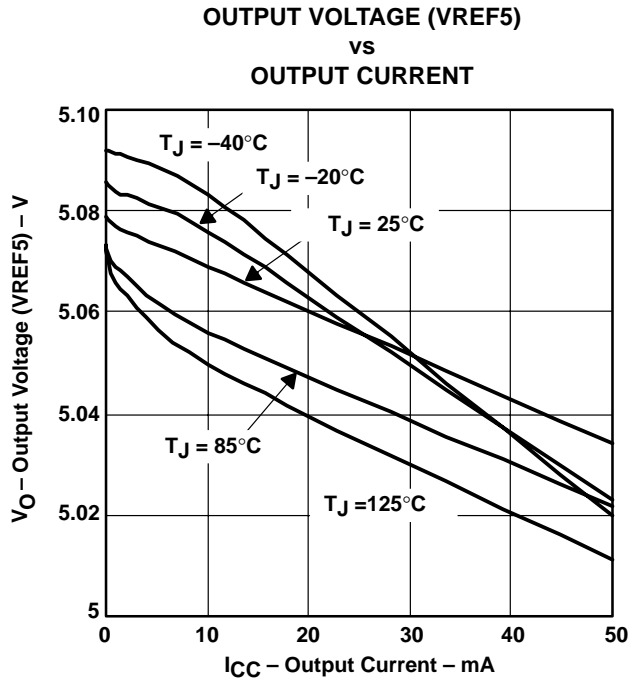

Figure 16

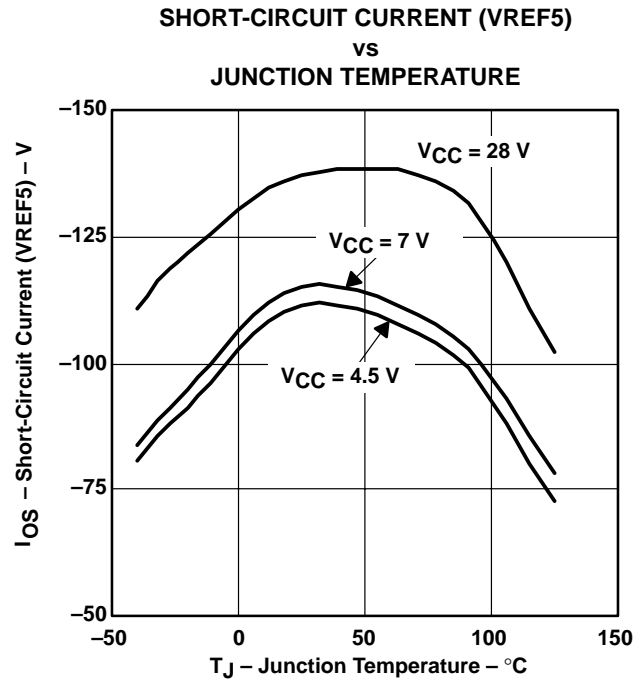

Figure 17

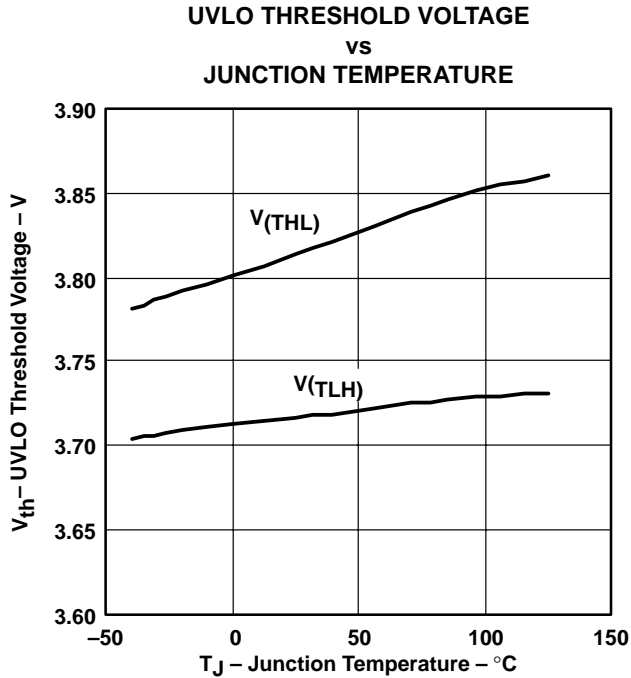

Figure 18

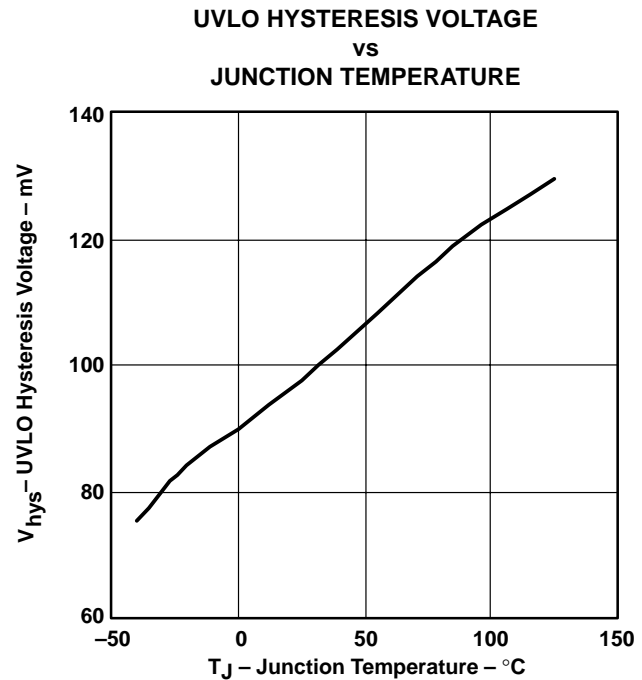

Figure 19

TYPICAL CHARACTERISTICS

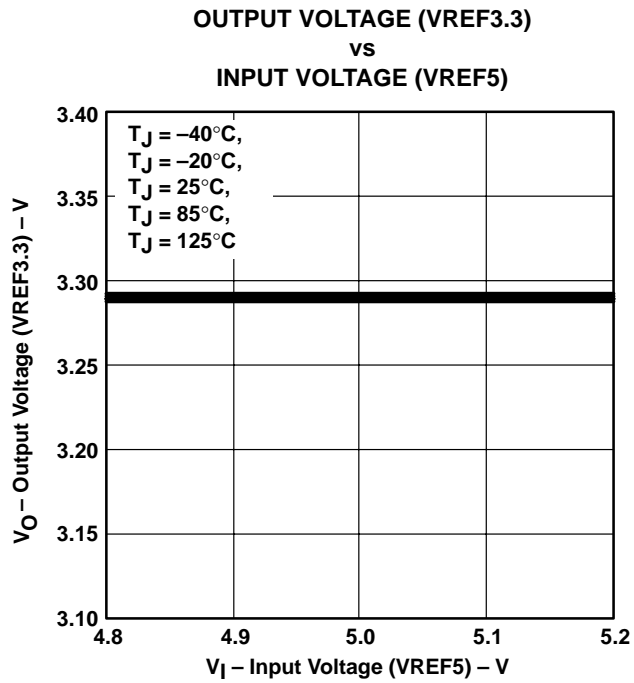

Figure 20

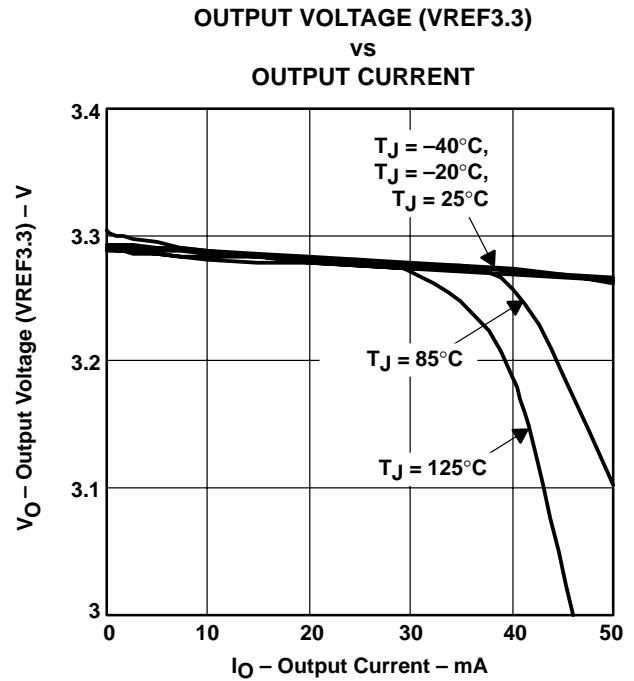

Figure 21

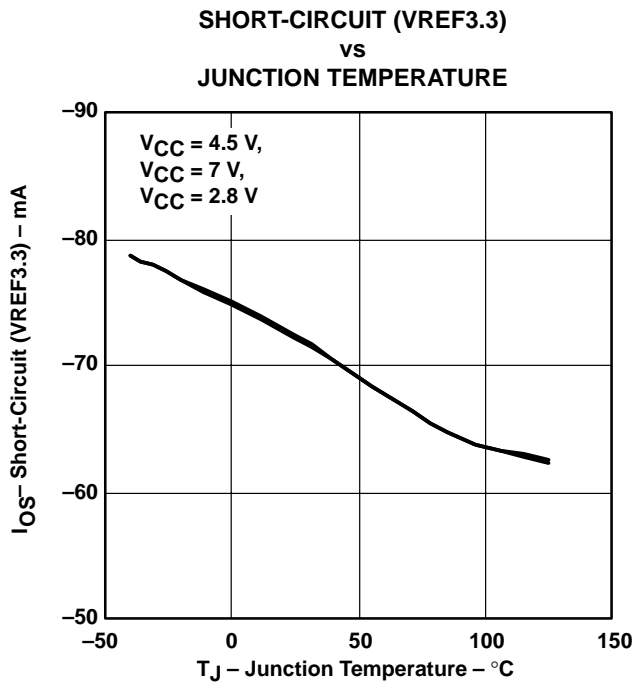

Figure 22

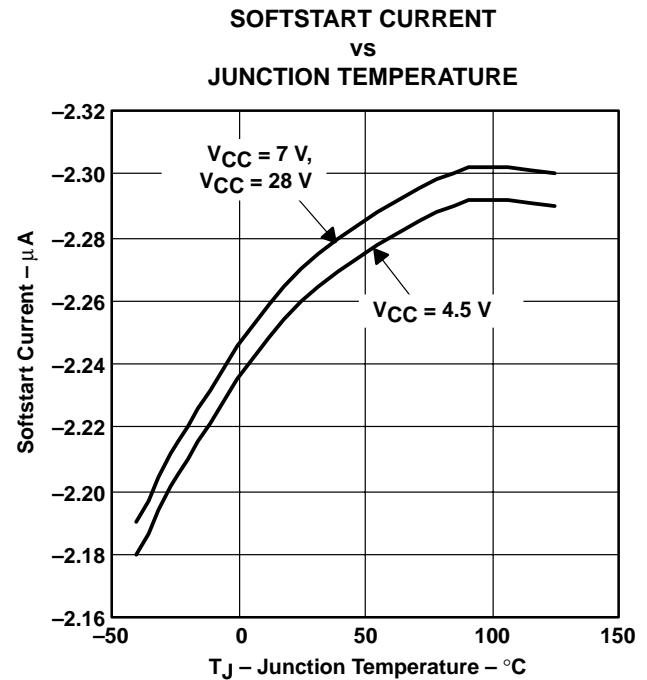

Figure 23

TPS5140 FOUR-CHANNEL DC/DC CONTROLLER FOR NOTEBOOK PC POWER

SLVS305A – DECEMBER 2000 – REVISED JANUARY 2001

TYPICAL CHARACTERISTICS

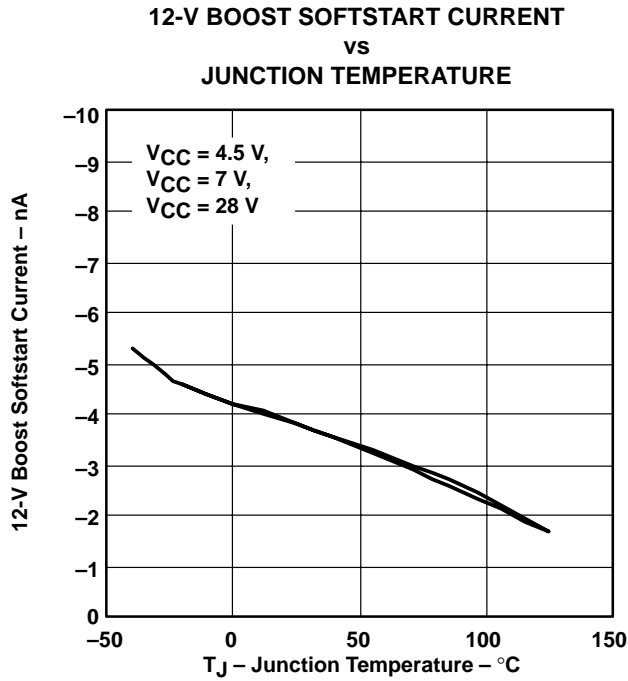

Figure 24

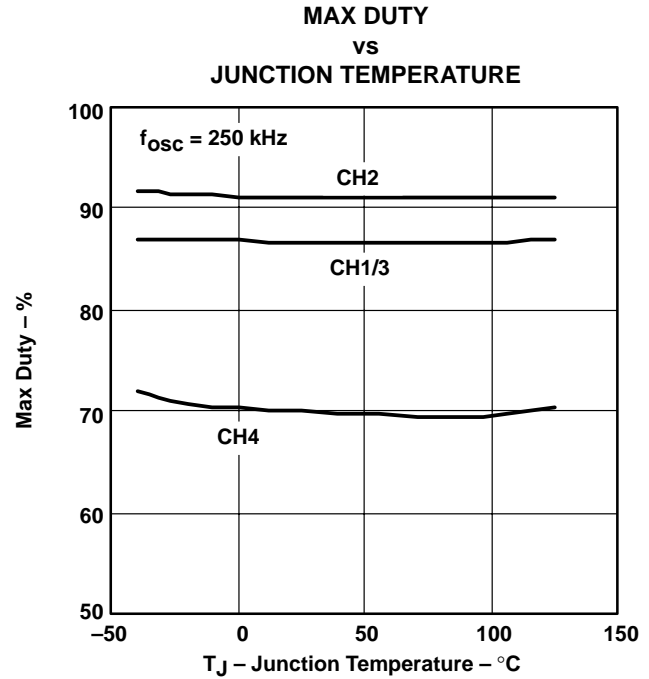

Figure 25

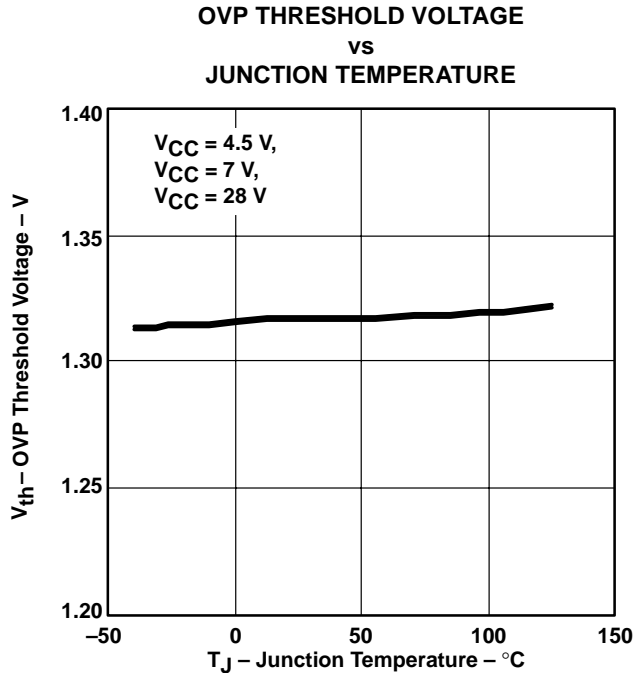

Figure 26

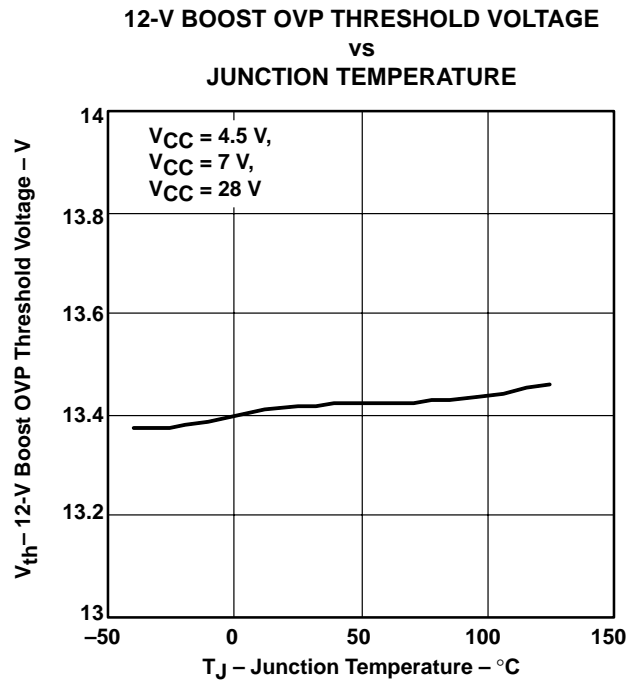

Figure 27



TYPICAL CHARACTERISTICS

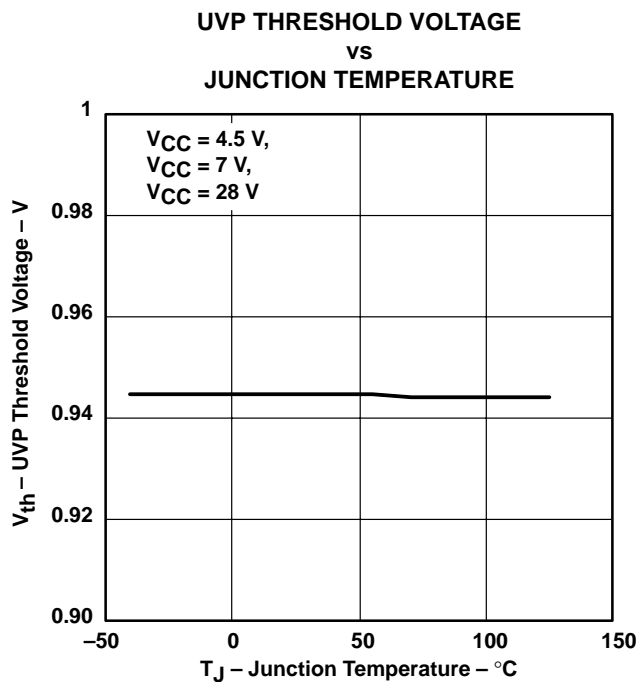

Figure 28

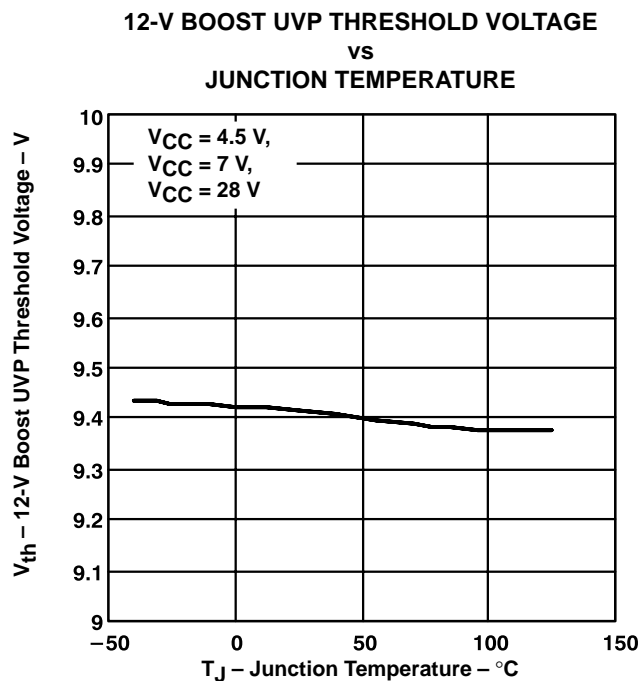

Figure 29

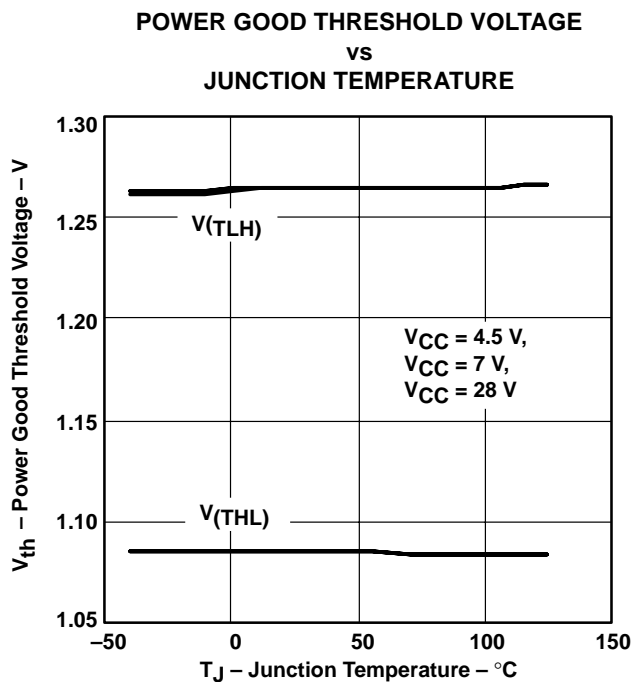

Figure 30

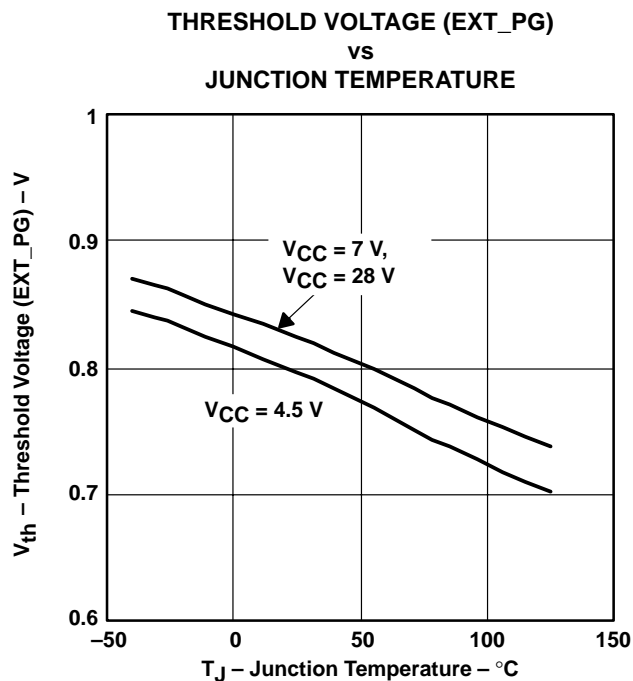

Figure 31

TPS5140 FOUR-CHANNEL DC/DC CONTROLLER FOR NOTEBOOK PC POWER

SLVS305A – DECEMBER 2000 – REVISED JANUARY 2001

TYPICAL CHARACTERISTICS

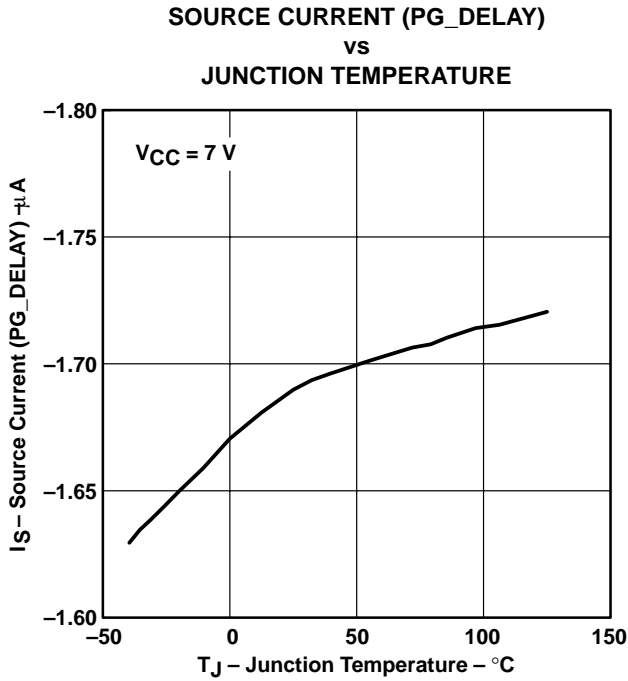

Figure 32

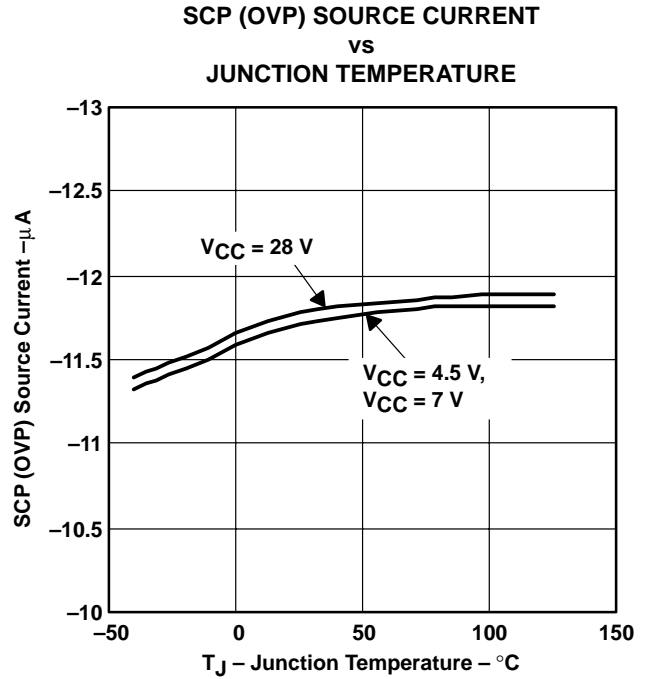

Figure 33

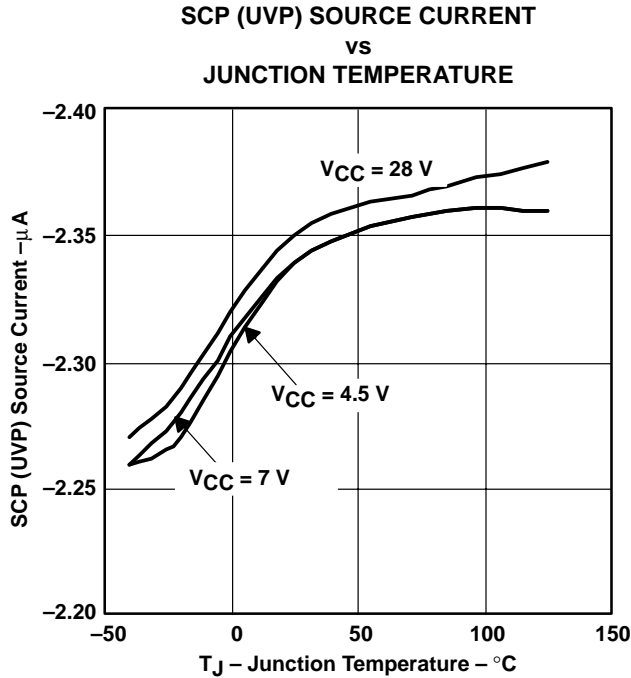

Figure 34

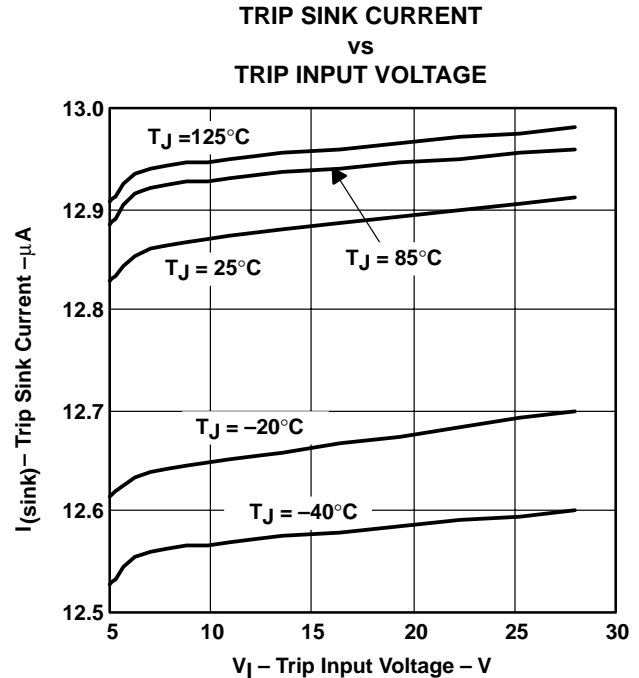

Figure 35

TYPICAL CHARACTERISTICS

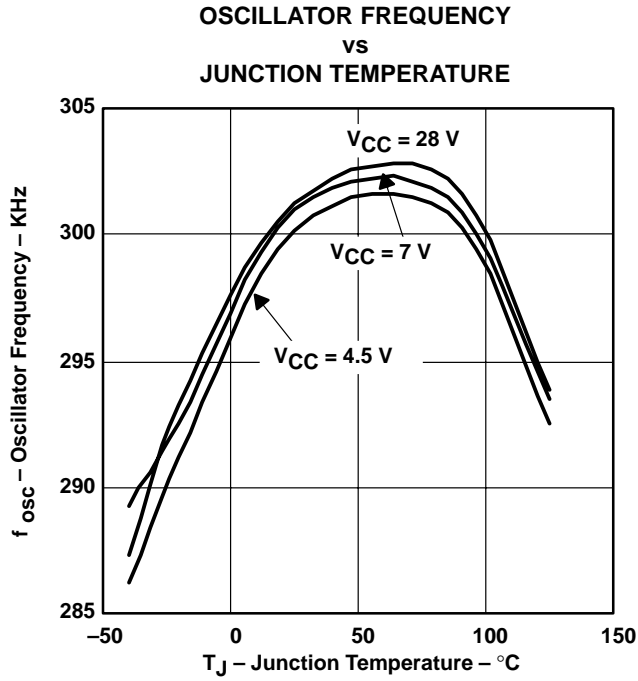

Figure 36

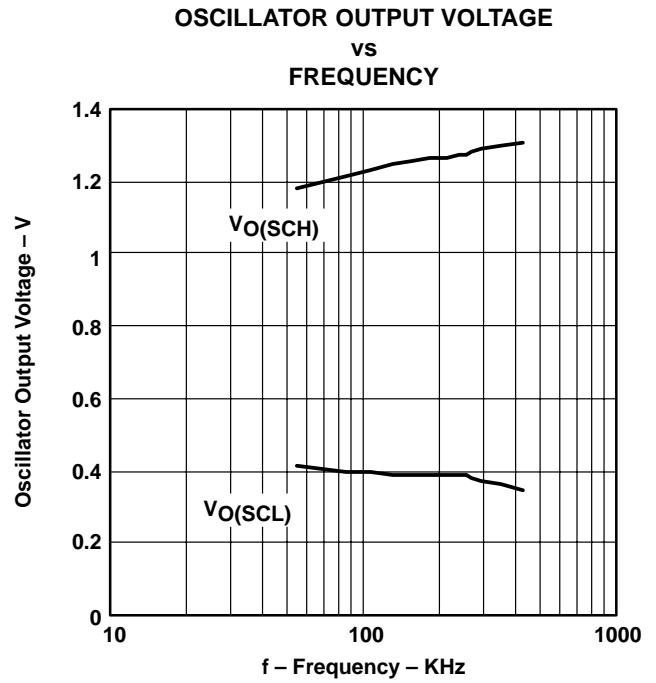

Figure 37

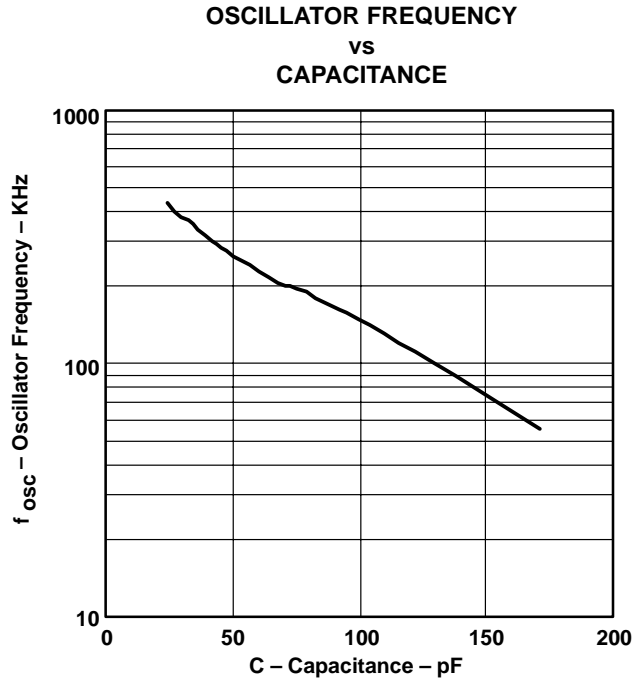

Figure 38

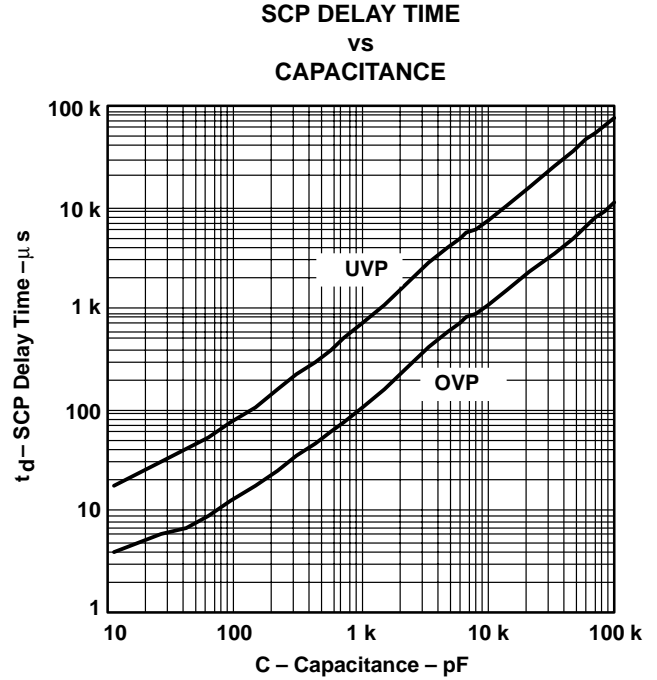

Figure 39

TPS5140 FOUR-CHANNEL DC/DC CONTROLLER FOR NOTEBOOK PC POWER

SLVS305A – DECEMBER 2000 – REVISED JANUARY 2001

TYPICAL CHARACTERISTICS

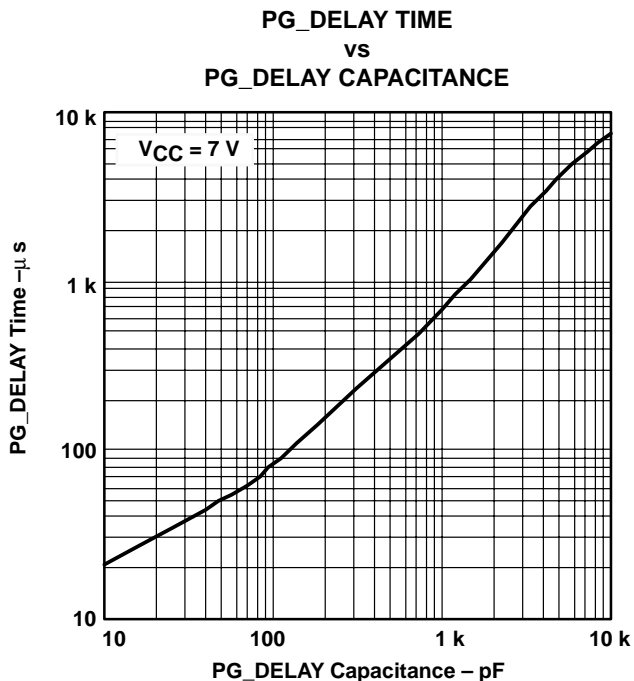

Figure 40

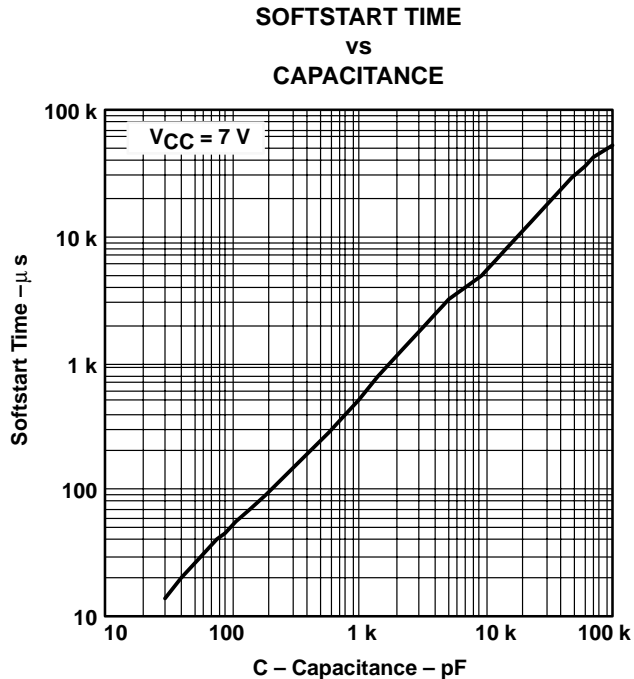

Figure 41

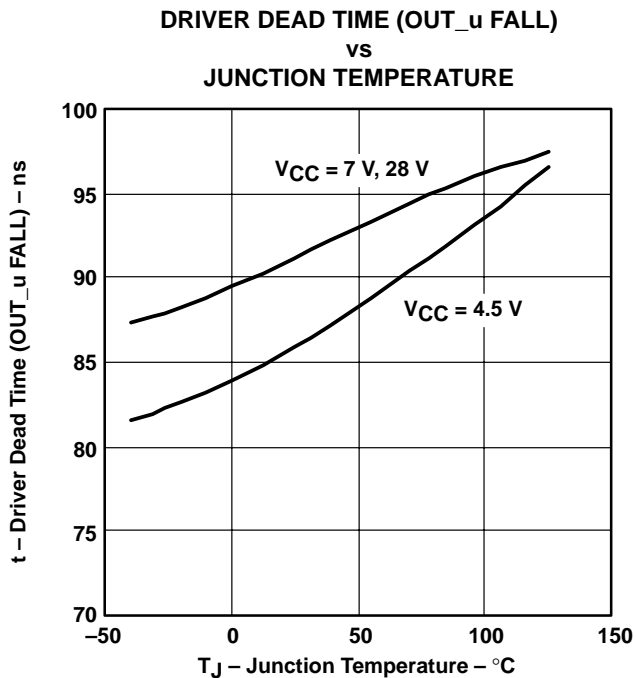

Figure 42

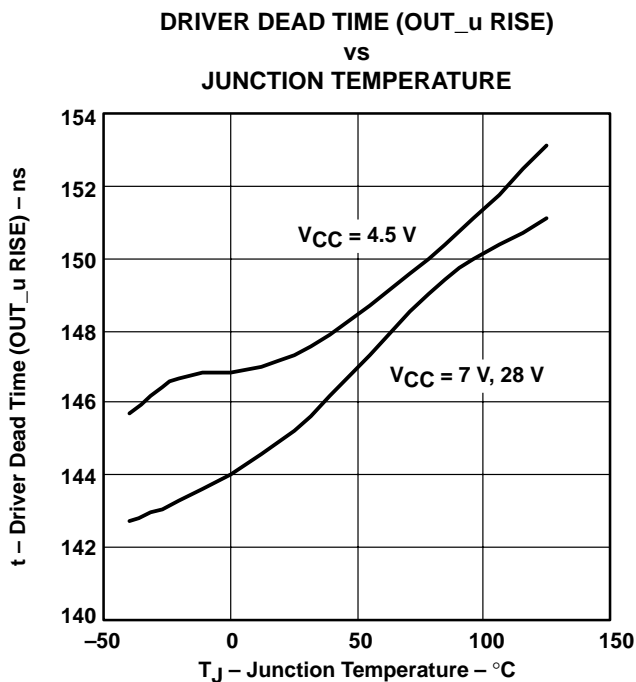

Figure 43



TPS5140 FOUR-CHANNEL DC/DC CONTROLLER FOR NOTEBOOK PC POWER

SLVS305A – DECEMBER 2000 – REVISED JANUARY 2001

APPLICATION INFORMATION

The design shown in this data sheet is a reference design for system power of notebook PC applications. An evaluation module (EVM), TPS5140EVM-172 (SLVP172), is available for customer testing and evaluation. The intent is to allow a customer to fully evaluate the given design using the plug-in EVM supply shown here. For subsequent customer board revisions, the EVM design can be copied onto the users' PCB to shorten design cycle. The following key design procedures will aid in the design of the notebook PC power supply using the TPS5140.

EVM input and outputs

		V _{O1}	V _{O2}	V _{O3}	V _{O4}
Output voltage	V _I range = 7 V ≈ 25 V	3.3 V	5 V	2.5 V	12 V
Maximum output current	I _{I(max)} = 9 A	4 A	5 A	2 A	120 mA

TPS5140 FOUR-CHANNEL DC/DC CONTROLLER FOR NOTEBOOK PC POWER

SLVS305A – DECEMBER 2000 – REVISED JANUARY 2001

APPLICATION INFORMATION

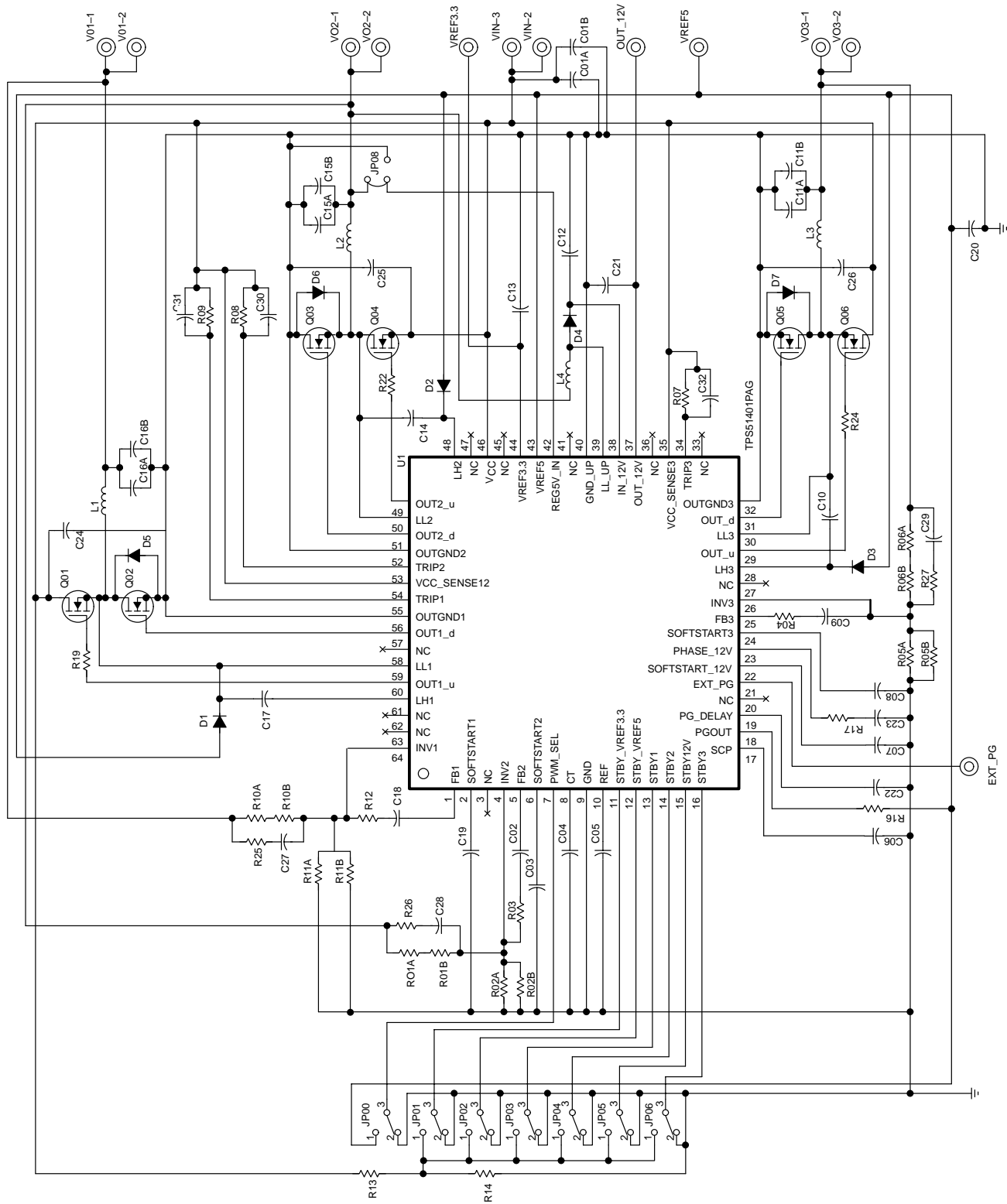

Figure 44. EVM Schematic



APPLICATION INFORMATION

SMPS (synchronous mode power supply)

output voltage setpoint calculation

The reference voltage and the voltage divider set the output voltage. In the TPS5140, the reference voltage is 1.185 V, and the divider is composed of two resistors in the EVM design that are R01A, R01B and R02A, R02B, or R10A, R10B and R11A, R11B, or R06A, R06B and R05A, R05B. The equation for the setpoint is:

$$R1 = \frac{R2 \times (V_O - V_{ref})}{V_{ref}}$$

where R1 is the top resistor (kΩ) (R01A and R01B, R10A and R10B or R06A and R06B); R2 is the bottom resistor (kΩ) (R02A and R02B, R11A and R11B or R05A and R05B); V_O is the required output voltage (V); V_{ref} is the reference voltage (1.185 V in TPS5140).

Example: $R2 = 10 \text{ k}\Omega$; $V_{ref} = 1.185 \text{ V}$; $V_O = 5 \text{ V}$, then $R1 = 32.19 \text{ k}\Omega$

Some of the most popular output voltage setpoints are calculated in the table below:

V_O	1.3 V	1.5 V	1.8 V	2.5 V	3.3 V	5 V
R1 (top) (kΩ)	0.97	2.66	5.19	11.10	17.85	32.19
R2 (bottom) (kΩ)	10	10	10	10	10	10

If user changes the resistor value, the R2 (bottom) value should be over 10 kΩ due to the phase compensation.

output inductor ripple current

The output inductor current $I_{(ripple)}$ can affect not only the efficiency, but also the output voltage ripple. The equation is exhibited below:

$$I_{(ripple)} = \frac{V_I - V_O - I_O \times (r_{DS(on)} + R_L)}{L_{(out)}} \times D \times t_s$$

where ripple is the peak-to-peak ripple current (A) through the inductor; V_I is the input voltage (V); V_O is the output voltage (V); I_O is the output current; $r_{DS(on)}$ is the on-time resistance of the MOSFET (Ω); R_L is the parasitic resistance of the inductor; D is the duty cycle; and t_s is the switching period (s). From the equation, it can be seen that the current ripple can be adjusted by changing the output inductor value.

Example: If $V_I = 10 \text{ V}$; $V_O = 5 \text{ V}$; $I_O = 5 \text{ A}$; $r_{DS(on)} = 26 \text{ m}\Omega$; $R_L = 5 \text{ m}\Omega$; $D = 0.50$; $t_s = 4 \text{ }\mu\text{s}$; $L_{(out)} = 6.1 \text{ }\mu\text{H}$, then the ripple current $I_{(ripple)} = 1.589 \text{ A}$.

output capacitor RMS current

Assuming the inductor ripple current goes completely through the output capacitor to ground, the RMS current in the output capacitor can be calculated as:

$$I_{O(rms)} = I_{(ripple)} \times \frac{\sqrt{3}}{6}$$

where $I_{O(rms)}$ is the maximum RMS current in the output capacitor (A) and $I_{(ripple)}$ is the peak-to-peak inductor ripple current (A).

Example: $I_{(ripple)} = 1.589 \text{ A}$, so $I_{O(rms)} = 0.459 \text{ A}$

TPS5140 FOUR-CHANNEL DC/DC CONTROLLER FOR NOTEBOOK PC POWER

SLVS305A – DECEMBER 2000 – REVISED JANUARY 2001

APPLICATION INFORMATION

SMPS (synchronous mode power supply) (continued)

input capacitor RMS current

Assuming the input current goes completely into the input capacitor to the power ground, the RMS current in the input capacitor can be calculated as:

$$I_{I(\text{rms})} = \sqrt{I_O^2 \times D \times (1-D)}$$

where $I_{I(\text{rms})}$ is the input RMS current in the input capacitor (A), I_O is the output current (A), and D is the duty cycle. From the equation, it can be seen that the highest input RMS current usually occurs at the lowest input voltage, so it is the worst case design for input capacitor ripple current.

Example: $I_O = 5 \text{ A}$; $D = 0.50$

Then, $I_{I(\text{rms})} = 2.5 \text{ A}$.

soft start

The soft start timing can be adjusted by selecting the soft start capacitor value. The equation is exhibited below:

$$C(\text{soft}) = \frac{2.3 \times T(\text{soft})}{1.185}$$

where $C(\text{soft})$ is the soft start capacitor (μF) (C19, C03 or C08 in EVM design), and $T(\text{soft})$ is the start up time (s).

Example: $T(\text{soft}) = 5 \text{ ms}$, so $C(\text{soft}) = 0.01 \mu\text{F}$.

current limit protection

The current limit in the TPS5140 on each channel is set using an internal current source and an external resistor (R09, R08 or R07). The sensed low-side MOSFET drain-to-source voltage is compared to the set point. If the voltage exceeds the limit, the internal oscillator is activated, and it continuously resets the current limit until the over-current condition is removed or SCP latches outputs off (see timer-latch SCP). The equation below should be used for calculating the external resistor value for the current protection set point. Also, only CH2 monitors both high-side and low-side MOSFET drain-to-source voltage.

$$R(\text{cl}) = \frac{r_{\text{DS(on)}} \times \left(I_{(\text{trip})} + \frac{I_{(\text{ripple})}}{2} \right)}{0.000013}$$

where $R(\text{cl})$ is the external current limit resistor (R09, R08 or R07), and $r_{\text{DS(on)}}$ is the low side MOSFET (Q02, Q03 or Q05) on-time resistance. $I_{(\text{trip})}$ is the required current limit and $I_{(\text{ripple})}$ is the peak-to-peak output inductor current.

Example: $r_{\text{DS(on)}} = 26 \text{ m}\Omega$, $I_{(\text{trip})} = 7 \text{ A}$, $I_{(\text{ripple})} = 1.589 \text{ A}$, so $R(\text{cl}) = 16 \text{ k}\Omega$.

APPLICATION INFORMATION

SMPS (synchronous mode power supply) (continued)

timer-latch SCP

The TPS5140 includes the function of the fault latch with timer to latch the MOSFET driver after constant time passes since the unusual condition of the output was detected. When the OVP or UVP comparator detects a fault condition, the timer starts to charge the SCP capacitor (C06), which is connected to the SCP terminal. If the SCP terminal goes up to 1.185 V, the fault latch is set.

- **over current protection and under voltage protection**

When the current limit circuit limits the output current, then the output voltage will go below the target output voltage and the UVP comparator detects a fault condition. The timer starts to charge the SCP capacitor when the UVP comparator detects the output under voltage and the fault latch will be set after $T_{(uvplatch)}$ has past. When UVP is latched, all output MOSFET drivers of the TPS5140 turn *OFF*. The equation below should be used for calculating the $T_{(uvplatch)}$:

$$C_{(scp)} = \frac{2.3 \times T_{(uvplatch)}}{1.185}$$

- **over voltage protection**

When OVP comparator detects the output over voltage, the timer starts to charge the SCP capacitor, and the fault latch will be set after $T_{(ovplatch)}$ has past. In case of OVP-latch, the high-side drivers of both channels are forced *OFF* and the low-side drivers of both channels are forced *ON*. The equation below should be used for calculating the $T_{(ovplatch)}$:

$$C_{(scp)} = \frac{11.5 \times T_{(ovplatch)}}{1.185}$$

where $C_{(scp)}$ is the external capacitor, $T_{(uvplatch)}$ is time from the UVP detection to latch, and $T_{(ovplatch)}$ is the time from OVP detection to latch.

Example: $T_{(uvplatch)} = 515 \mu\text{s}$, $T_{(ovplatch)} = 103 \mu\text{s}$, so $C_{(scp)} = 0.001 \mu\text{F}$

notice—usage of timer-latch

The SCP should not be set to a lower voltage (or GND) while the device is holding the latch-off status of the OVP or UVP. If the SCP terminal is manually set to a lower voltage in this term, an output overshoot may occur. The TPS5140 must be reset by grounding the STBY1,2,3 and STBY_VREF5,3.3 or by dropping the V_{CC} below the UVLO voltage.

disablement the protection function

When debugging the circuit once preliminary calculations have been performed, the evaluation may be hampered because the protection circuitry does not operate properly. In this case, the TPS5140 is able to invalidate the protection circuits for debugging.

OCP: Removing the resistor for the current limit and opening the TRIP terminal can disable the OCP.
 OVP, UVP: Grounding the SCP terminal can disable the OVP and UVP.

TPS5140

FOUR-CHANNEL DC/DC CONTROLLER FOR NOTEBOOK PC POWER

SLVS305A – DECEMBER 2000 – REVISED JANUARY 2001

APPLICATION INFORMATION

3.3 V linear regulator

The VREF3.3 terminal is the output of the 3.3-V linear regulator. The VREF3.3 terminal should be connected to an output capacitor. A ceramic capacitor of 4.7 μ F is recommended for stability of the output voltage.

REG5V_IN

The REG5V_IN terminal should be connected to the external 5 V (output of CH2), to decrease the power dissipation. Also, this terminal has an OVP comparator. If this terminal voltage exceeds a threshold voltage, the timer starts to charge the SCP capacitor, and all of output is forced to *OFF*.

12 V boost up converter

The TPS5140 has a boost up converter (12 V). The inductor (L4) which uses this boost up converter should be connected to the external 5 V. Also, the inductor value is recommended to be 22 μ H. The OUT_12V terminal should be connected to the output capacitor. A ceramic capacitor of 10 μ F is recommended for stability of the output voltage. It is also recommended that a ceramic capacitor (around 0.1 μ F) be connected between the IN_12V terminal and the GND_UP terminal.

soft start 12 V

This soft start terminal is connected to the internal capacitor. To extend the soft start time, this terminal should be connected to the external capacitor. The equation is:

$$\left(30 + C_{(\text{ext})} \right) \times 1.185 = 3.8 \times T_{(\text{soft_12V})}$$

where $C_{(\text{ext})}$ is the 12-V soft start capacitor (pF) and $T_{(\text{soft_12V})}$ is the start-up time (ms).

Example: $C_{(\text{ext})} = 33$ pF, so $T_{(\text{soft_12V})} = 19.6$ ms



APPLICATION INFORMATION

phase compensation for 12-V boost

The 12-V boost up converter is compensated to the phase margin. If the output components are changed, the phase margin will change. Therefore, the phase margin needs to be compensated. A resistor and capacitor should be connected in series from the PHASE_12V terminal to GND. If the inductor used is 22 μ H and the output capacitor is 10 μ F (ceramic), there is no need to compensate. The equivalent circuit of the 12-V boost is shown in Figure 45.

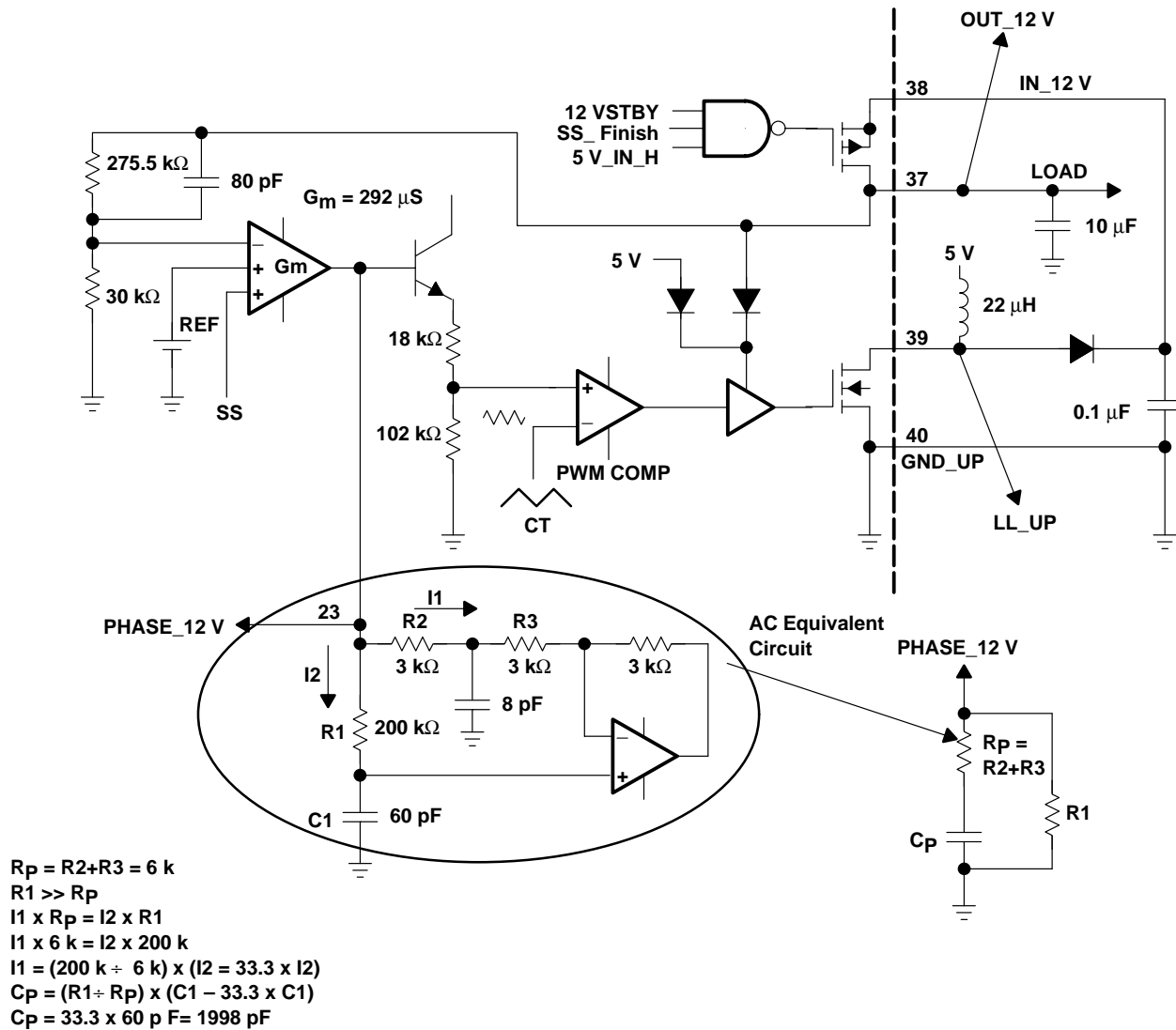

Figure 45. THS5140 12-V boost circuit

TPS5140 FOUR-CHANNEL DC/DC CONTROLLER FOR NOTEBOOK PC POWER

SLVS305A – DECEMBER 2000 – REVISED JANUARY 2001

APPLICATION INFORMATION

auto PWM/SKIP

Auto PWM/SKIP function monitors the drain-source voltage of the low-side MOSFET.

In the PWM mode to SKIP mode, when output currents decrease, the negative voltage between LL to GND is decreasing. If this voltage is positive voltage to GND, the auto SKIP circuit detects the SKIP mode. After a fixed time, the controller changes to SKIP mode.

In the SKIP mode to PWM mode, when output currents increase, the positive voltage between LL to GND is decreasing. In the SKIP mode, the auto PWM detect circuit has an offset voltage of about 20 mV. If the positive voltage between LL to GND decreases and becomes negative beyond the offset voltage of the GND level, then the auto PWM circuit detects the PWM mode, and the controller changes to the PWM mode.

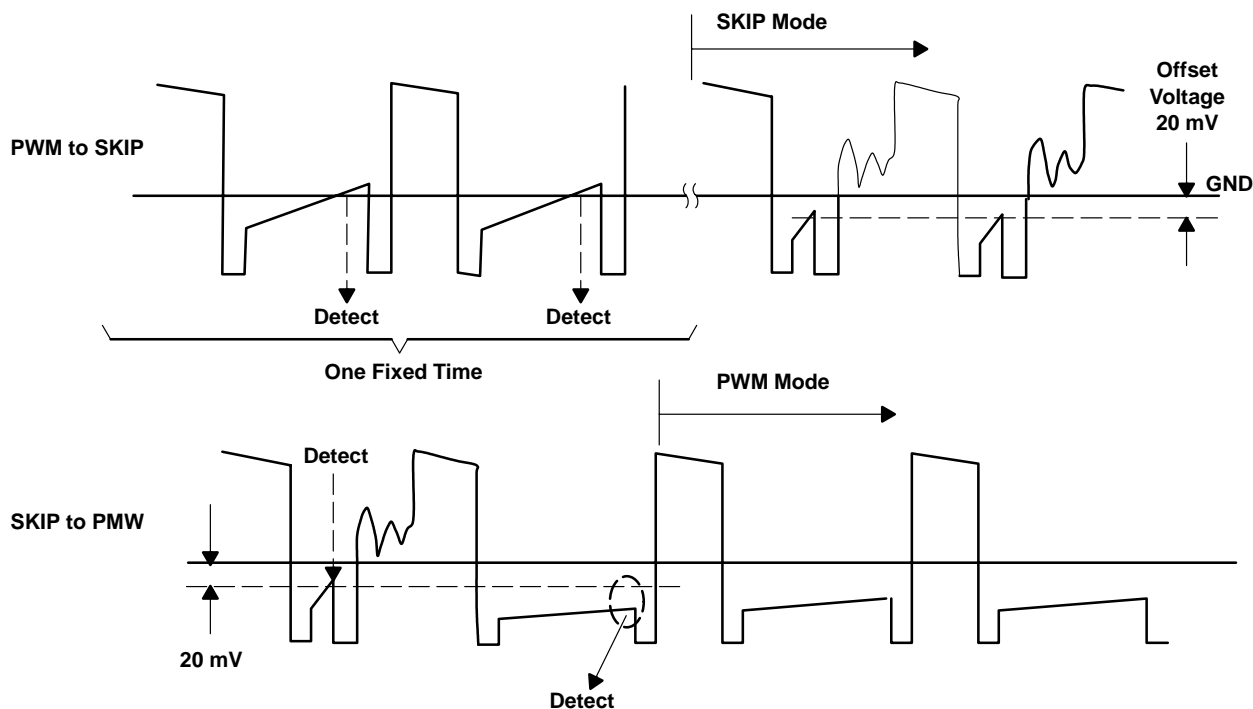

Figure 46. Timing Chart for the Auto PWM/SKIP Mode Function

APPLICATION INFORMATION

layout guidelines

Good power supply results will only occur when care is given to proper design and layout. Layout will affect noise pickup and generation yet cause a good design to perform with less than expected results. With a range of currents from milliamps to tens of amps, good power supply layout is much more difficult than most general PCB designs. The general design should proceed from the switching node to the output, then back to the driver section and, finally, parallel the low-level components. Below are several specific points to consider before the layout of a TPS5140 design begins.

- ANAGND and DRVGND should be isolated as much as possible.
- All sensitive analog components should reference to ANAGND. Terminals INV1/2/3, REF, CT, GND, SCP, and SOFTSTART1/2/3/12V should be placed in ANAGND.
- Ideally, all of the area under TPS5140 is also ANAGND.
- The source of the low-side MOSFETs should not be placed in the trace from ANAGND to DRVGND otherwise ANAGND is under the influence of output noise.
- The switch transitions in one channel may disturb the operation of other channels. So, the impedance between V_{CC} and GND wiring pattern should be as small as possible.
- The PCB is a four-layer pattern. This should be composed of power plane, power ground plane, signal ground plane, and signal plane.

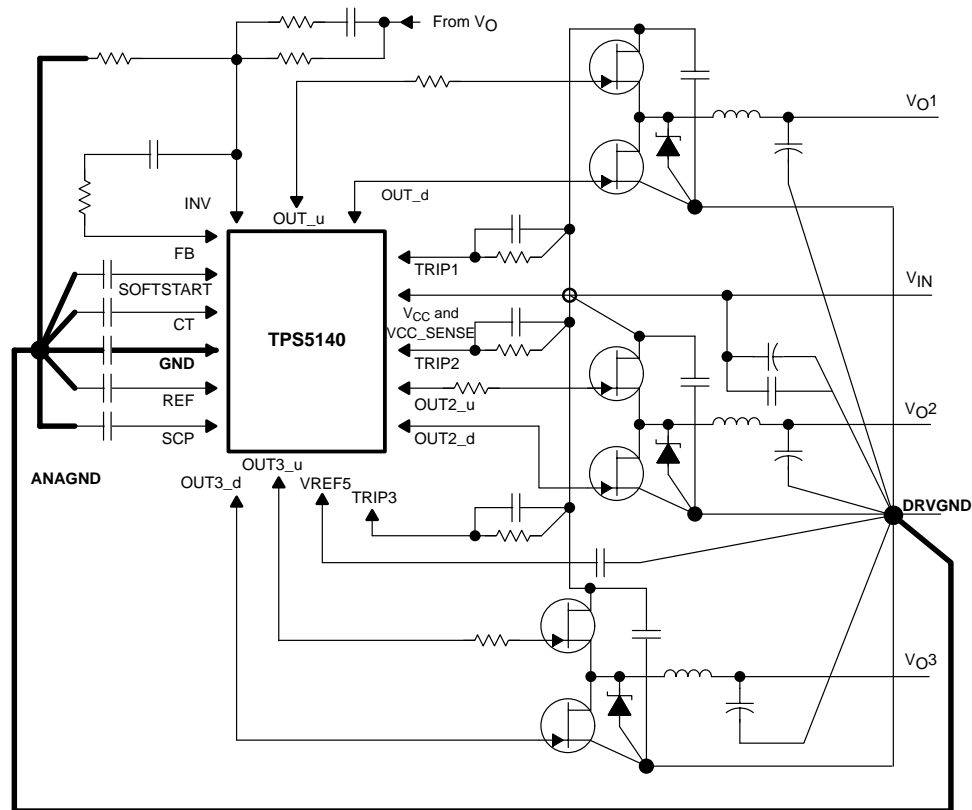

Figure 47. SLVP172 Four Layer PCB Diagram

TPS5140 FOUR-CHANNEL DC/DC CONTROLLER FOR NOTEBOOK PC POWER

SLVS305A – DECEMBER 2000 – REVISED JANUARY 2001

APPLICATION INFORMATION

layout guidelines (continued)

- DRVGND will connect to the main ground plane, close to the source of the low-side MOSFET.
- OUTGND1/2/3 should be placed close to the source of low-side MOSFET.
- The parallel Schottky diode, the high frequency bypass capacitors for MOSFETs, and the source of the low-side MOSFETs should be placed as close to each other as possible.

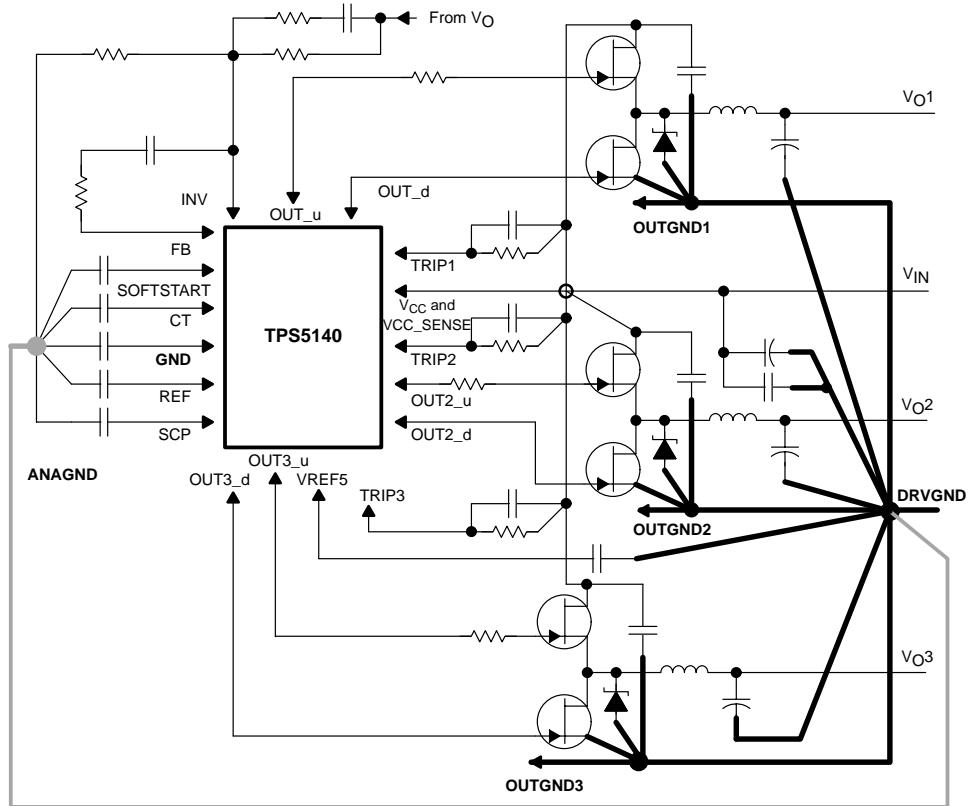

Figure 48. SLVP172 Low-Side MOSFETs Diagram

APPLICATION INFORMATION

layout guidelines (continued)

- Connections from the drivers to the gate of the power FETs should be as short and as wide as possible to reduce stray inductance. This becomes more critical if the external gate resistors are not being used. In addition, when dealing with current limit noise when using a MOSFET with a large input capacitance, a gate resistor should be inserted on the high side MOSFET to reduce the switching noise of the MOSFET.
- The connection from LL to the power FETs should be as short as and wide as possible.

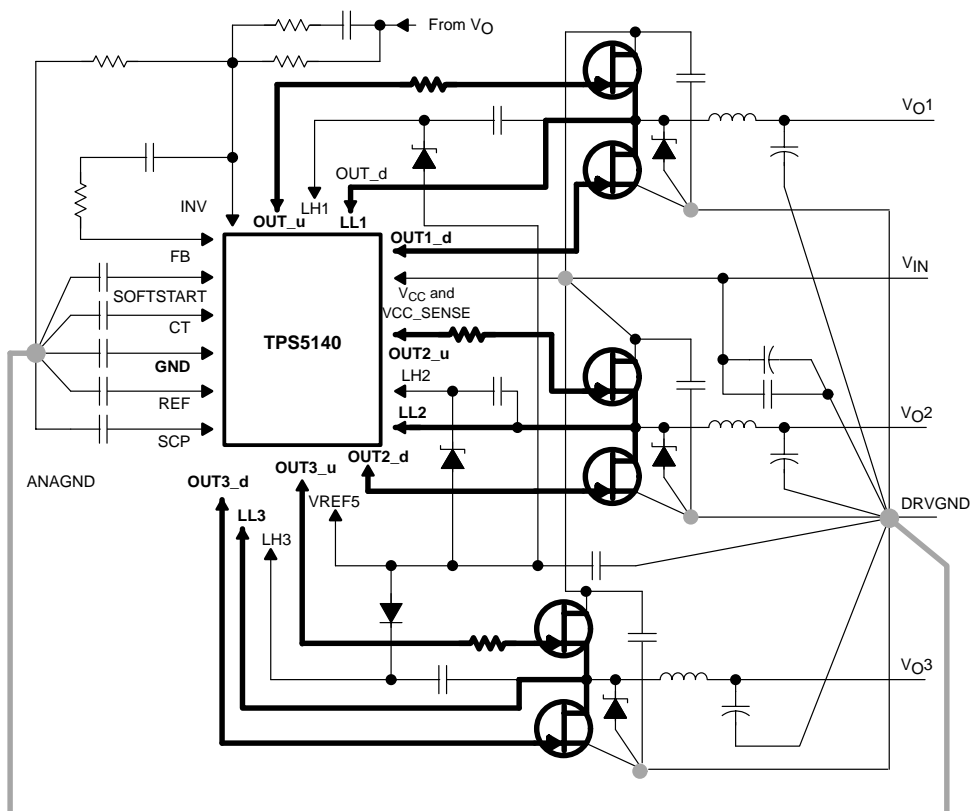

Figure 49. Connections From the Drivers to the Gate Diagram

TPS5140 FOUR-CHANNEL DC/DC CONTROLLER FOR NOTEBOOK PC POWER

SLVS305A – DECEMBER 2000 – REVISED JANUARY 2001

APPLICATION INFORMATION

layout guidelines (continued)

- The bypass capacitor for V_{CC} should be placed close to the TPS5140.
- The bulk storage capacitors across V_I should be placed close to the power FETs. High-frequency bypass capacitors should be placed in parallel with the bulk capacitors and connected close to the drain of the high-side FET and to the source of the low-side FET.
- Current limit set resistors must be connected to the drain of the high-side FET. A 0.1- μF capacitor should be placed in parallel with these resistors to align the phase between the drain of high-side FETs and the trip pin.

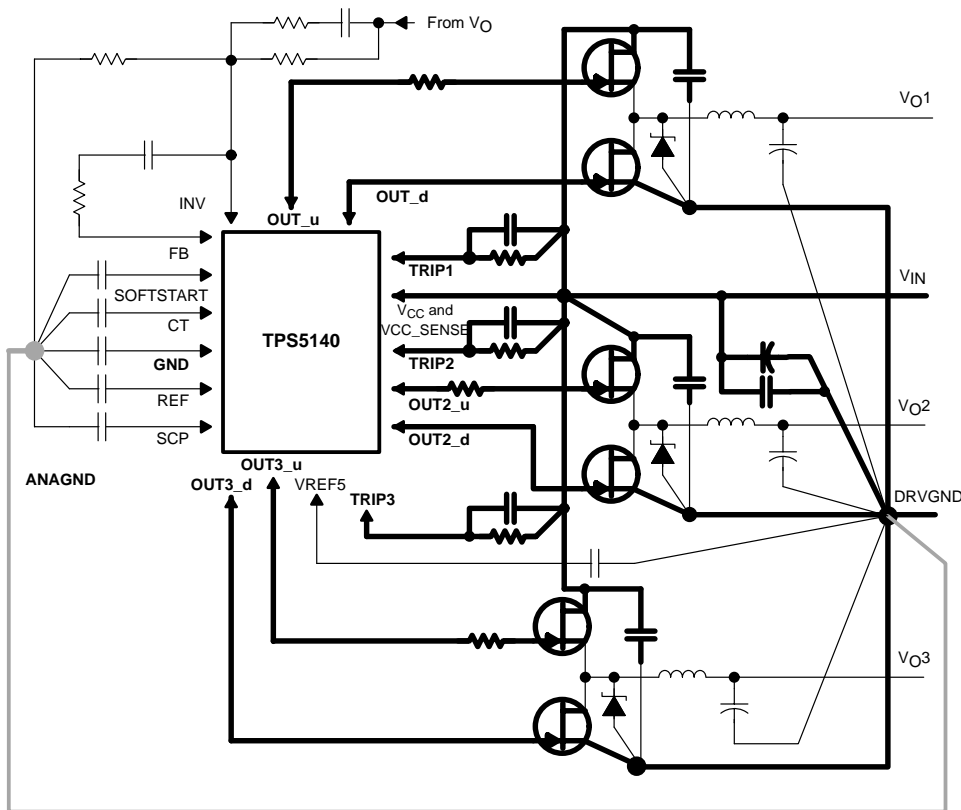

Figure 50. Bypass Capacitor Diagram

APPLICATION INFORMATION

layout guidelines (continued)

- The capacitor for VREF5 should be placed close to the TPS5140.
- The bootstrap capacitor (connected from LH to LL) should be placed close to the TPS5140.
- LH and LL should be routed close to each other to minimize differential mode noise coupling to these traces.
- The VREF5 capacitor should be placed close to DRVGND.
- LH and LL should not be routed near the control pin area. (ex. INV, FB, REF, etc.)

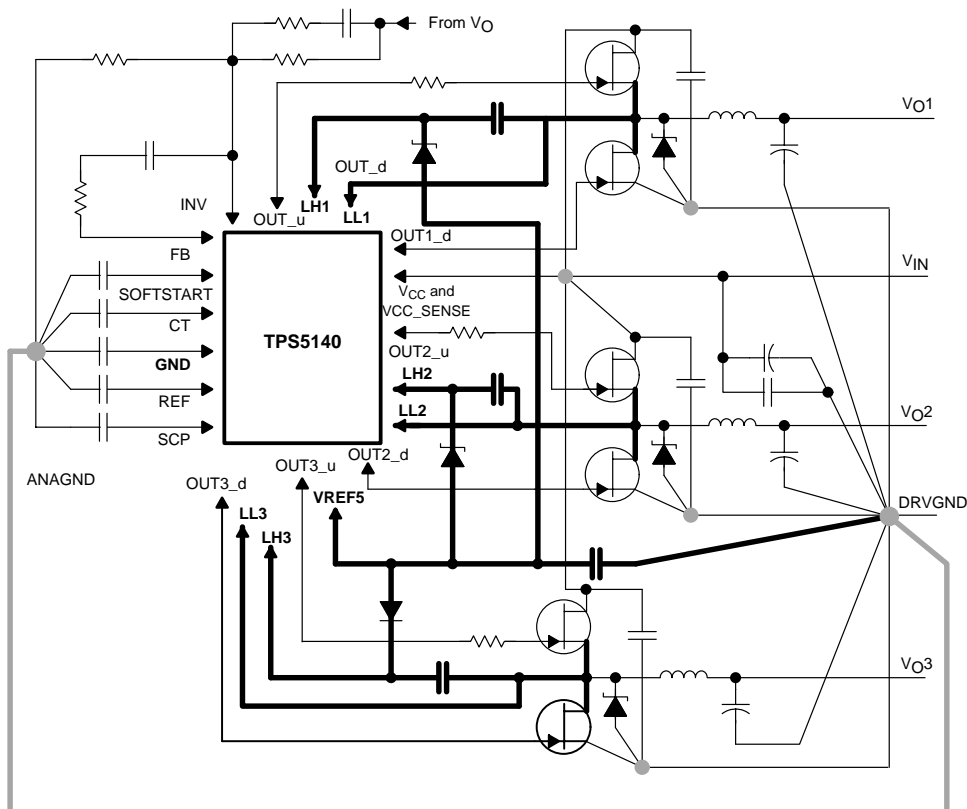

Figure 51. VREF5 Capacitor Diagram

TPS5140 FOUR-CHANNEL DC/DC CONTROLLER FOR NOTEBOOK PC POWER

SLVS305A – DECEMBER 2000 – REVISED JANUARY 2001

APPLICATION INFORMATION

layout guidelines (continued)

- The output voltage sensing trace should be isolated by either ground trace.
- The output voltage sensing trace should not be routed under the inductors on same layer of the PCB.
- The feedback components should be isolated from the output components such as MOSFETs, inductors, and output capacitors. Otherwise noise from the output components may couple into the feedback signal lines.
- The resistors for the output voltage set point should be connected to ANAGND.
- INV1/2/3 line should be as short as possible.

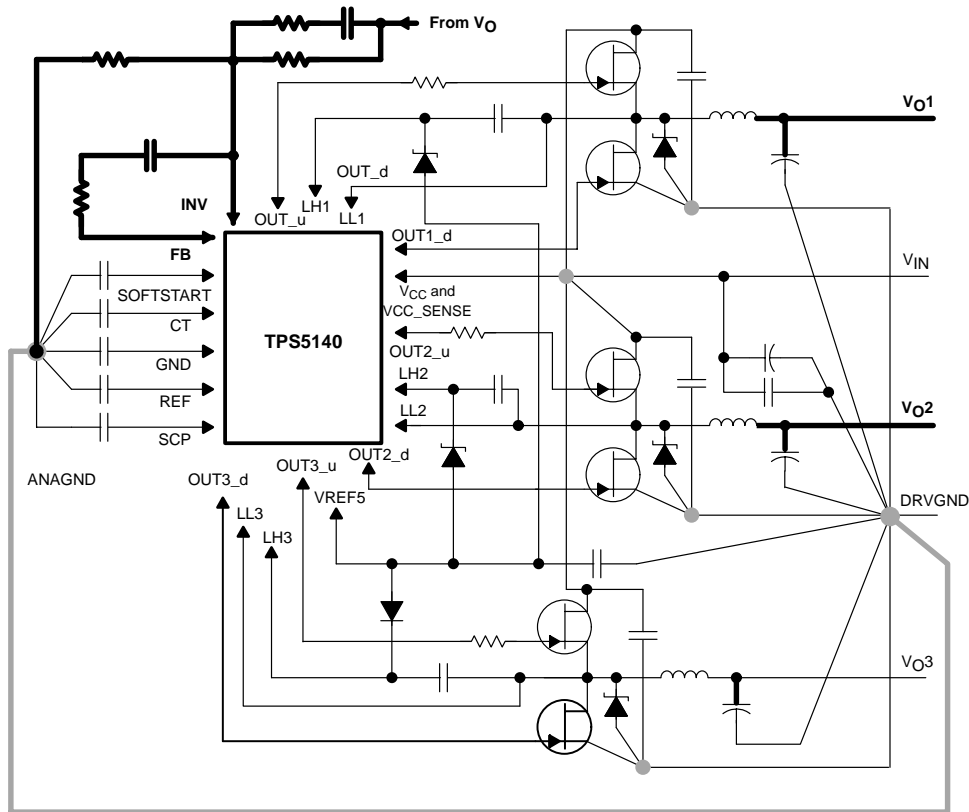

Figure 52. Output Voltage Diagram

APPLICATION INFORMATION

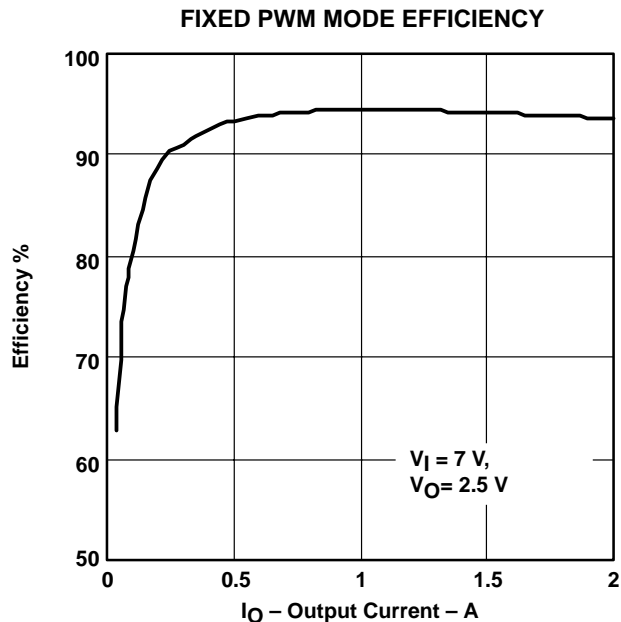

Figure 53

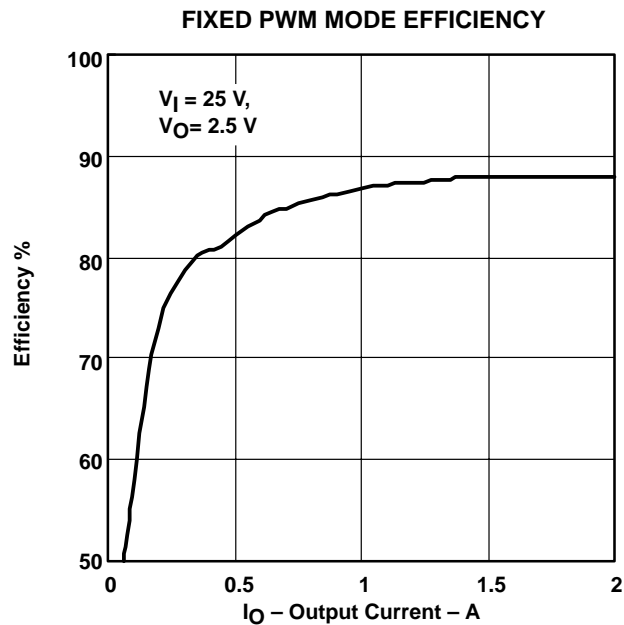

Figure 54

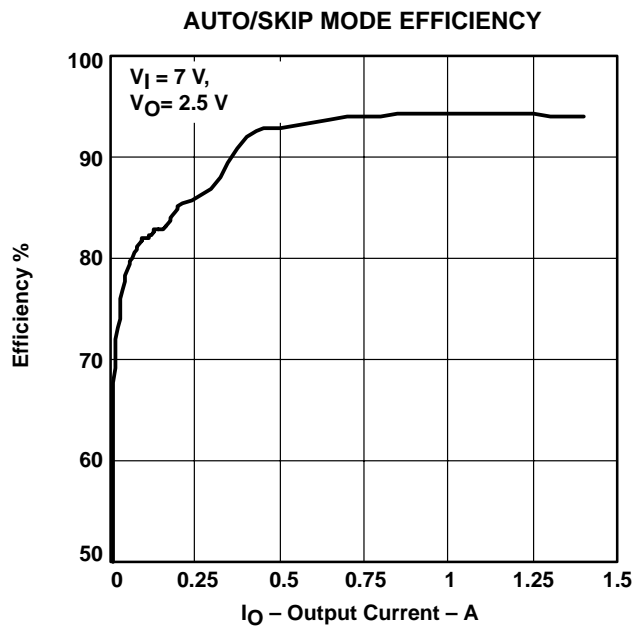

Figure 55

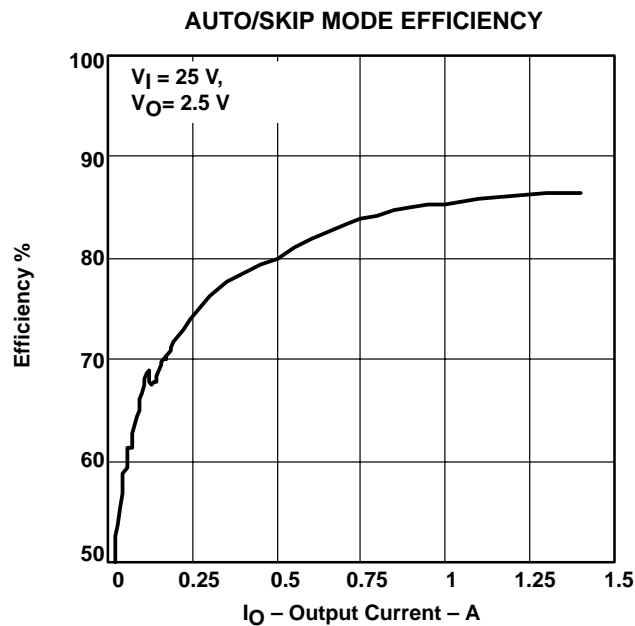

Figure 56

TPS5140 FOUR-CHANNEL DC/DC CONTROLLER FOR NOTEBOOK PC POWER

SLVS305A – DECEMBER 2000 – REVISED JANUARY 2001

APPLICATION INFORMATION

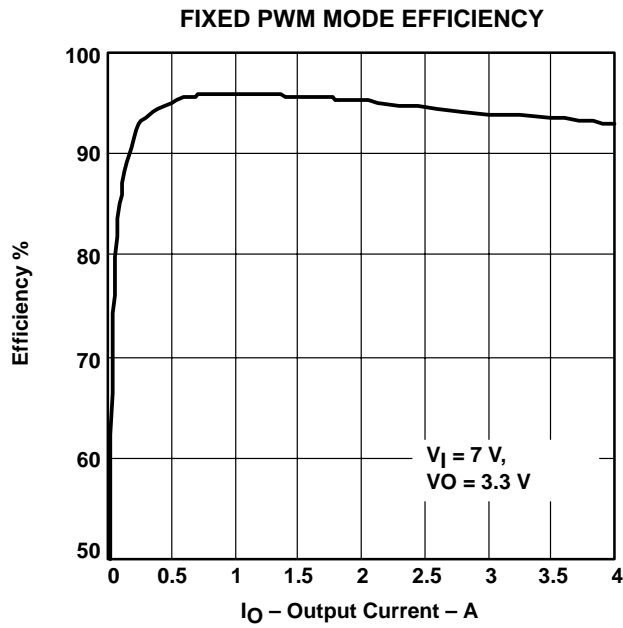

Figure 57

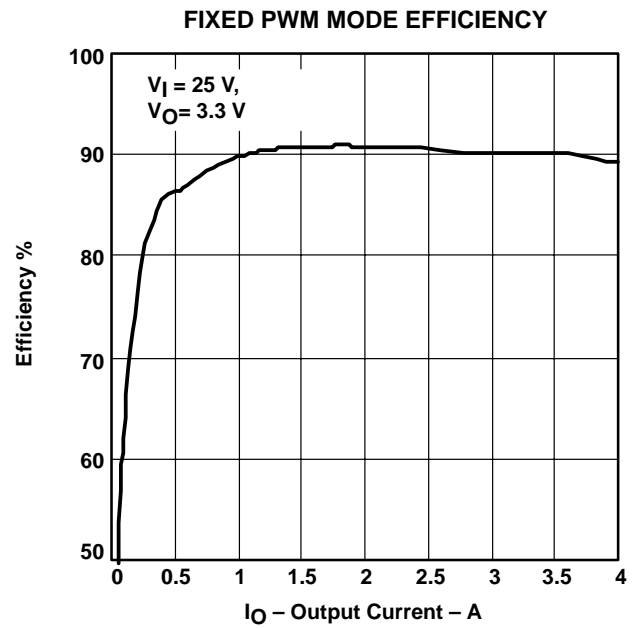

Figure 58

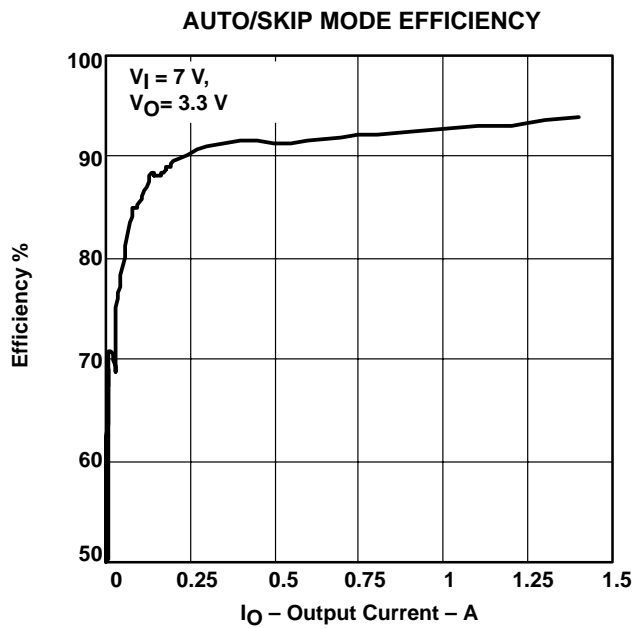

Figure 59

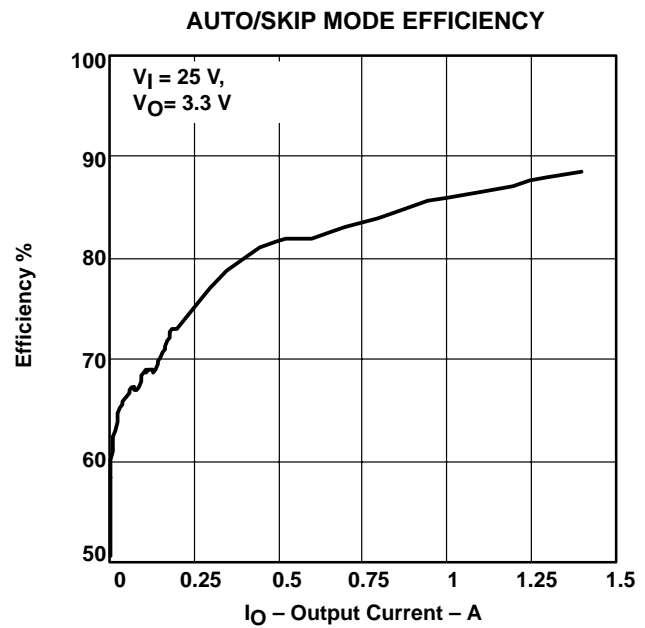

Figure 60

APPLICATION INFORMATION

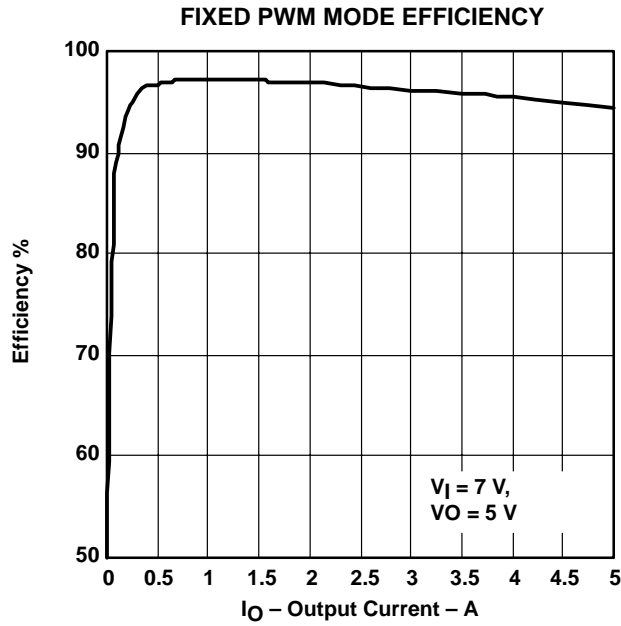

Figure 61

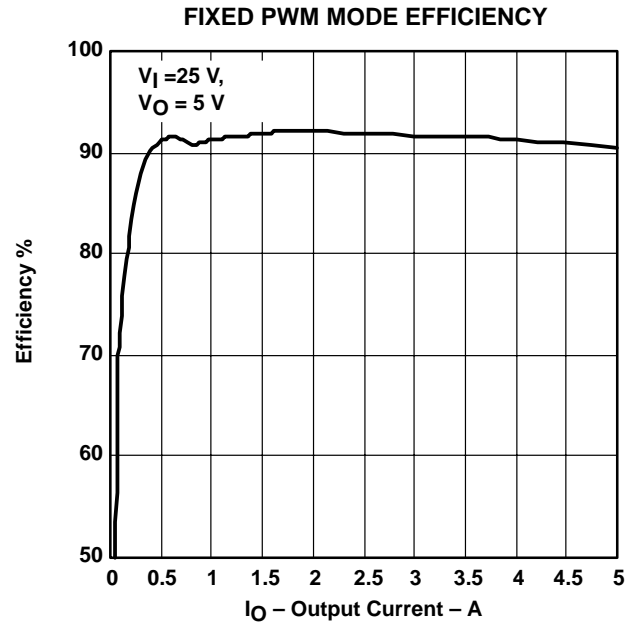

Figure 62

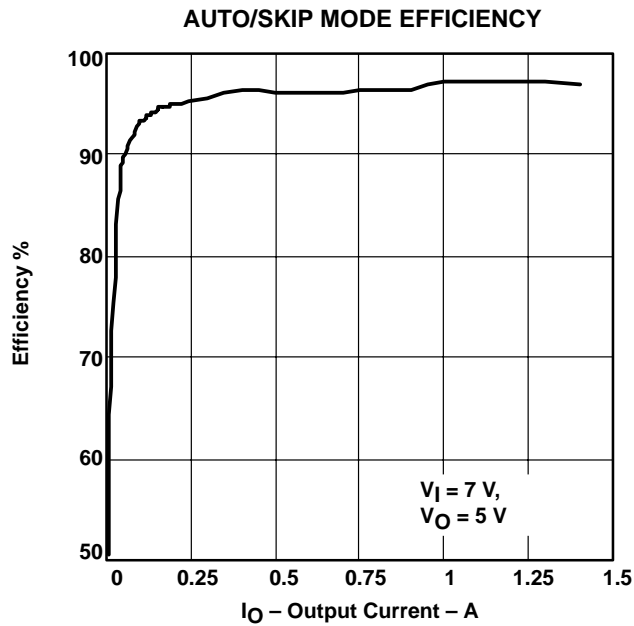

Figure 63

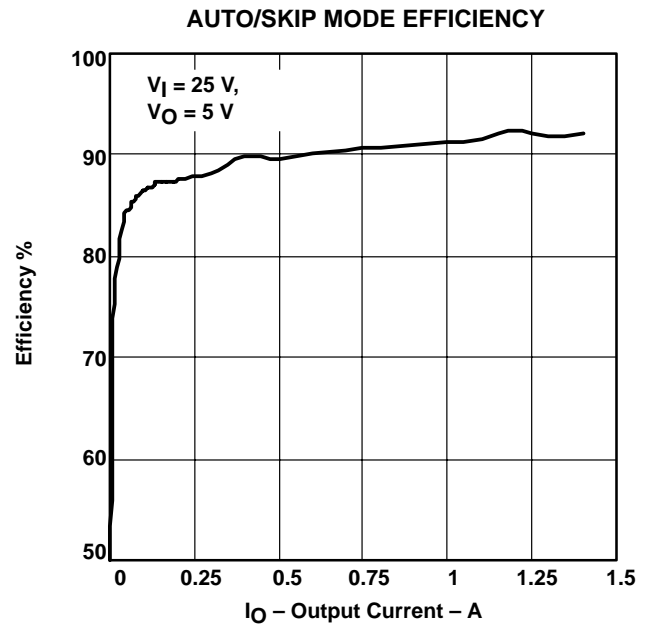

Figure 64

TPS5140 FOUR-CHANNEL DC/DC CONTROLLER FOR NOTEBOOK PC POWER

SLVS305A – DECEMBER 2000 – REVISED JANUARY 2001

APPLICATION INFORMATION

12 V BOOST EFFICIENCY

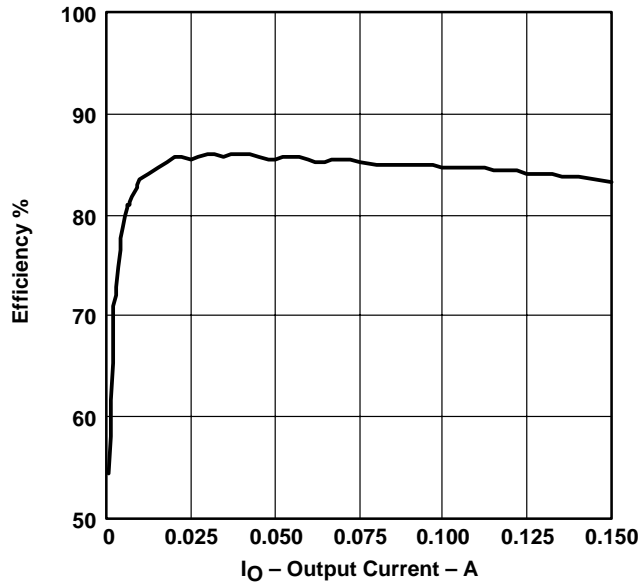

Figure 65

OUTPUT LINE REGULATION

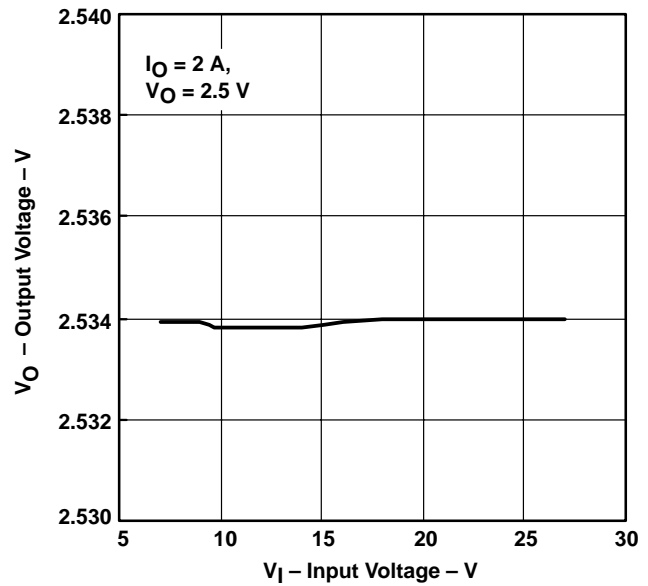

Figure 66

OUTPUT LINE REGULATION

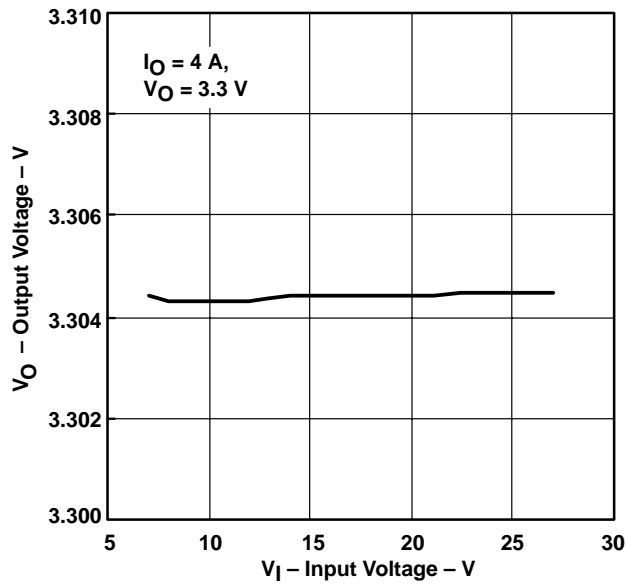

Figure 67

OUTPUT LINE REGULATION

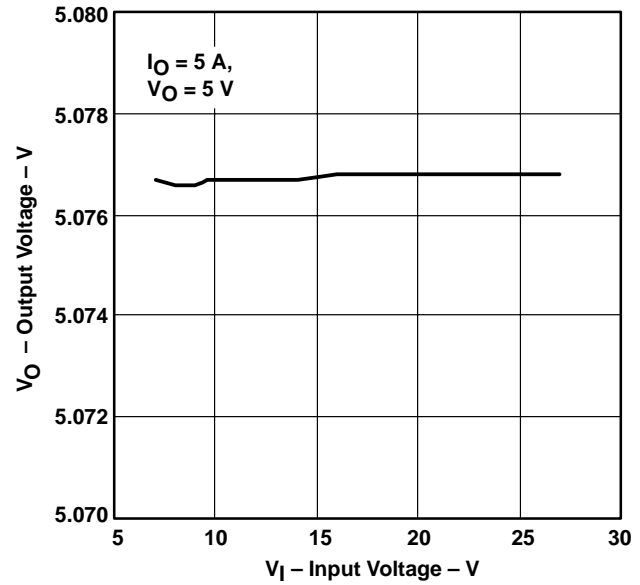

Figure 68

APPLICATION INFORMATION

OUTPUT LINE REGULATION

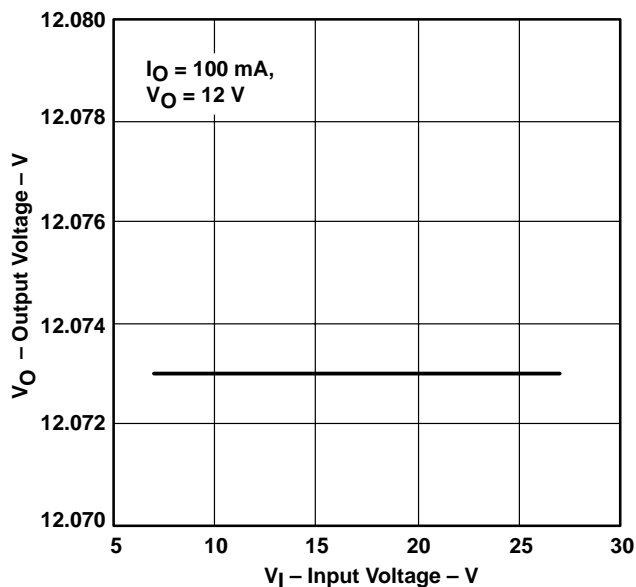

Figure 69

OUTPUT LOAD REGULATION

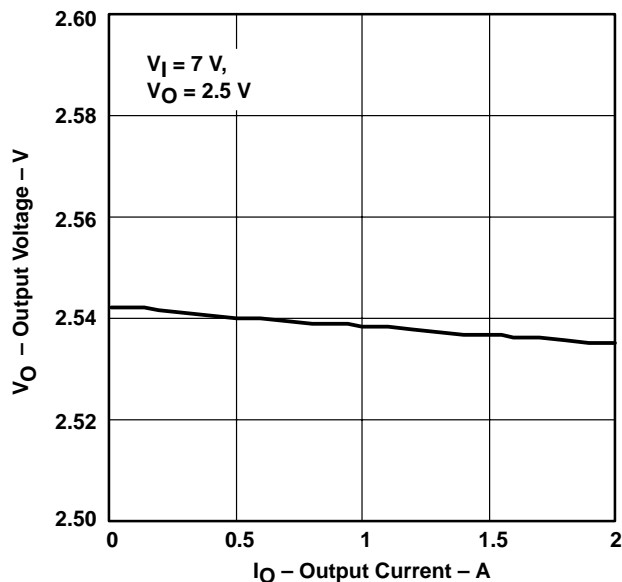

Figure 70

OUTPUT LOAD REGULATION

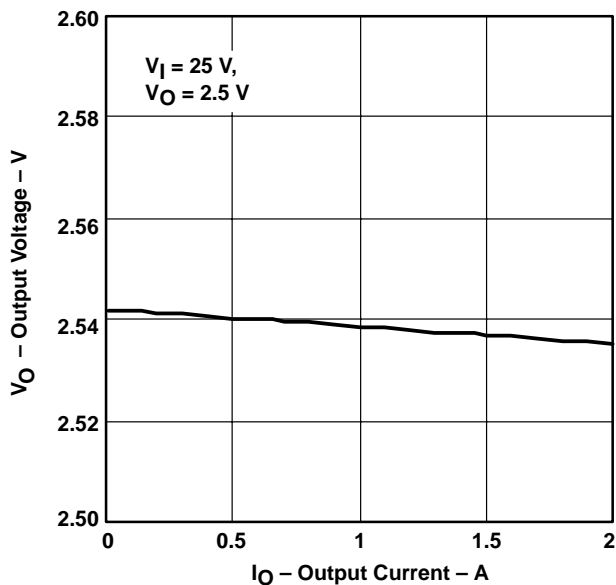

Figure 71

OUTPUT LOAD REGULATION

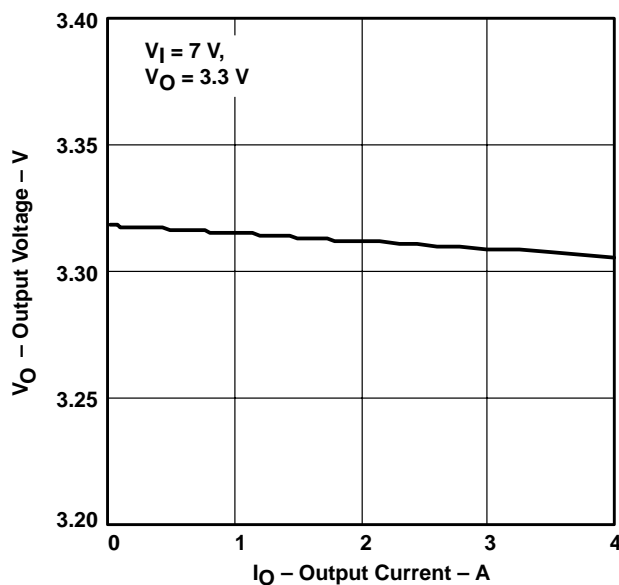

Figure 72

TPS5140 FOUR-CHANNEL DC/DC CONTROLLER FOR NOTEBOOK PC POWER

SLVS305A – DECEMBER 2000 – REVISED JANUARY 2001

APPLICATION INFORMATION

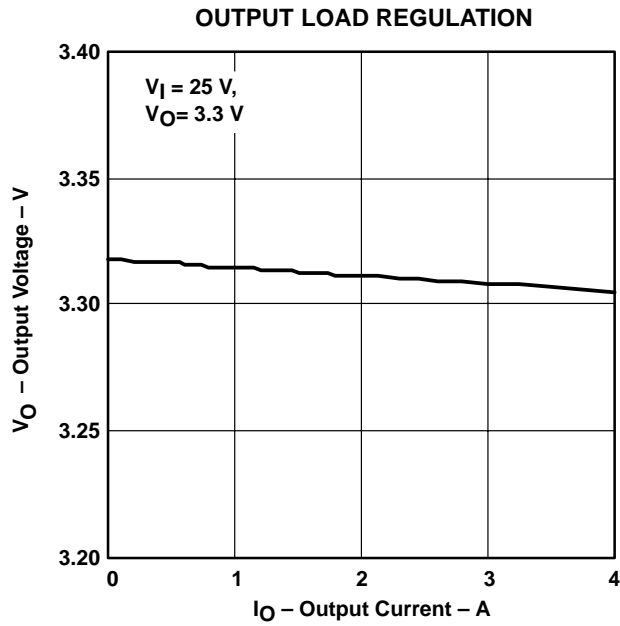

Figure 73

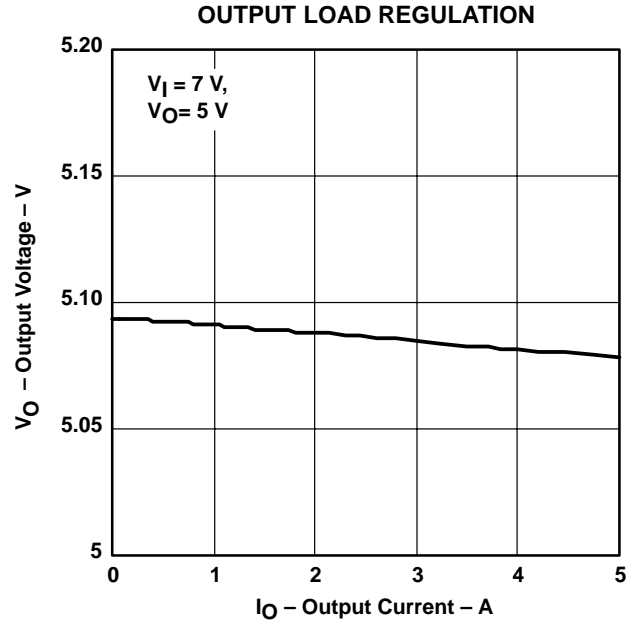

Figure 74

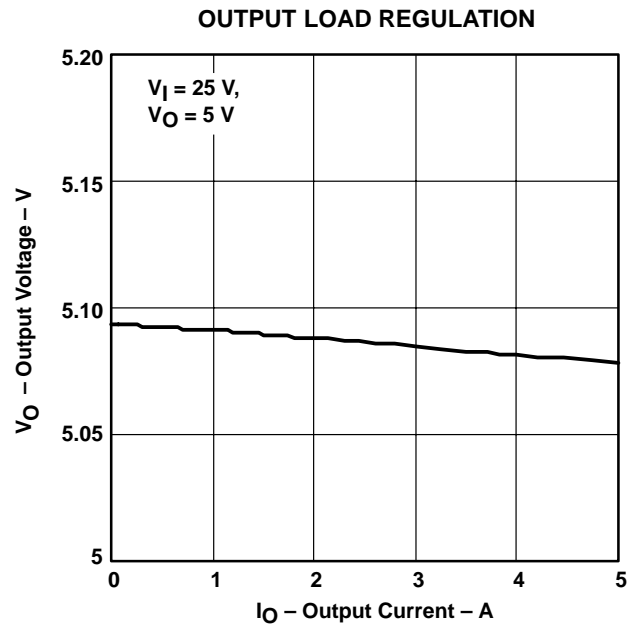

Figure 75

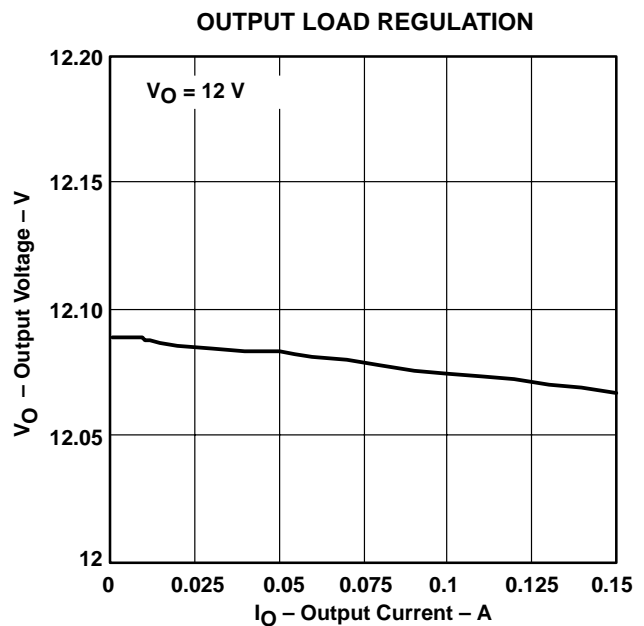

Figure 76

APPLICATION INFORMATION

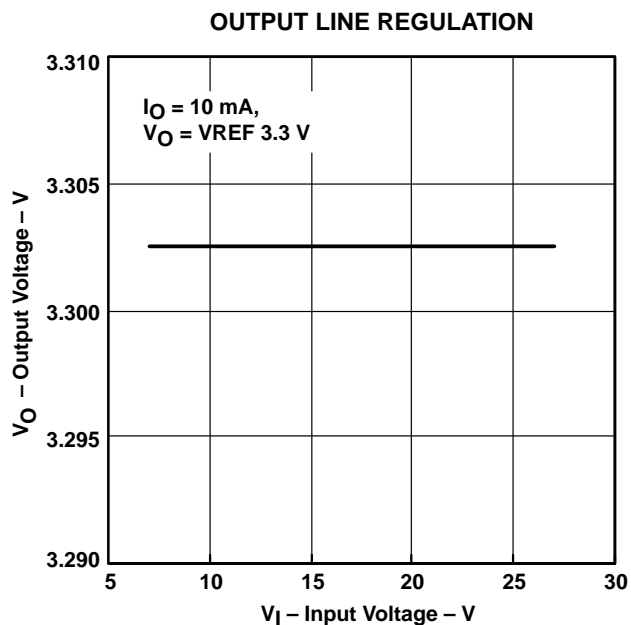

Figure 77

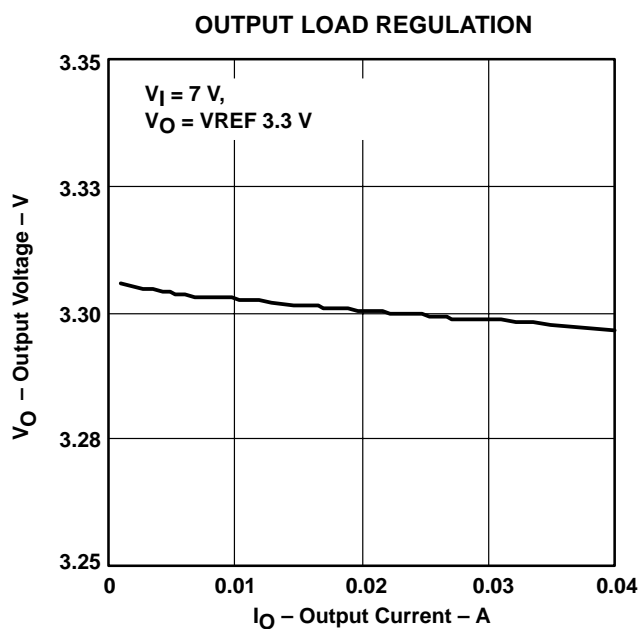

Figure 78

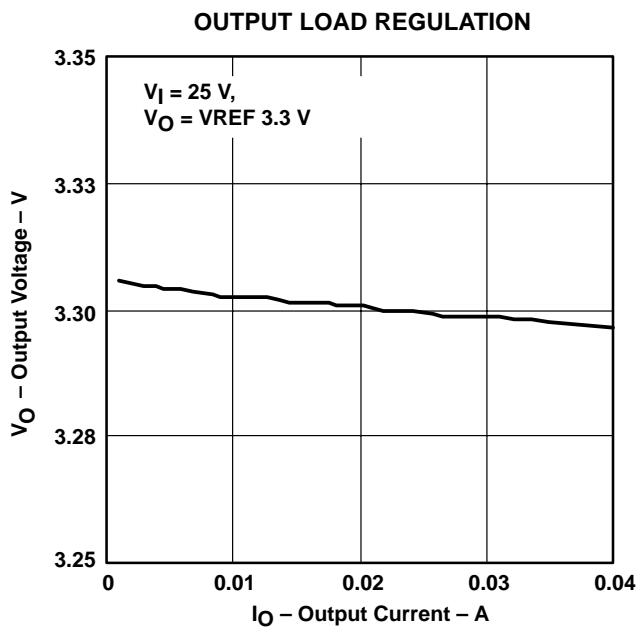

Figure 79

TPS5140 FOUR-CHANNEL DC/DC CONTROLLER FOR NOTEBOOK PC POWER

SLVS305A – DECEMBER 2000 – REVISED JANUARY 2001

APPLICATION INFORMATION

2.5 V OUTPUT VOLTAGE RIPPLE

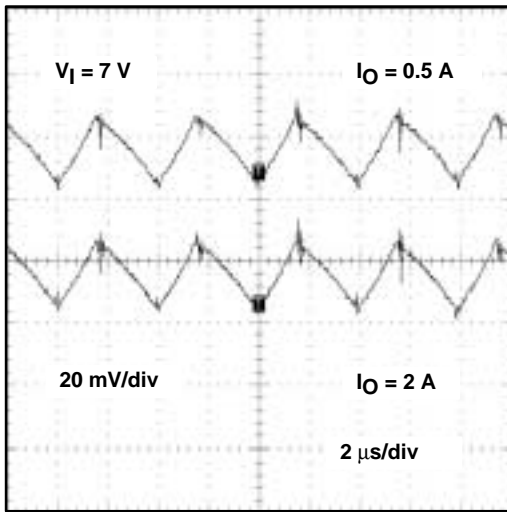

Figure 80

3.3 V OUTPUT VOLTAGE RIPPLE

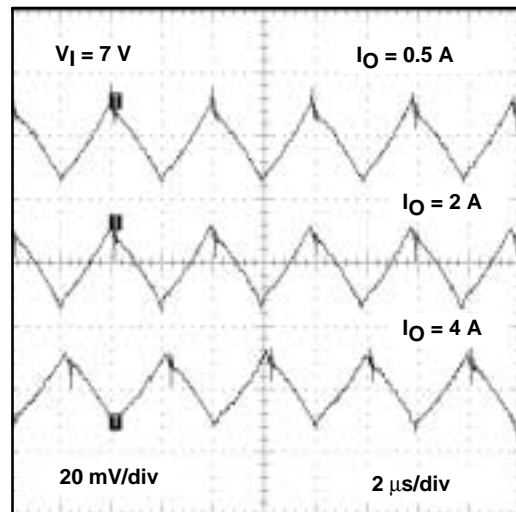

Figure 81

5 V OUTPUT VOLTAGE RIPPLE

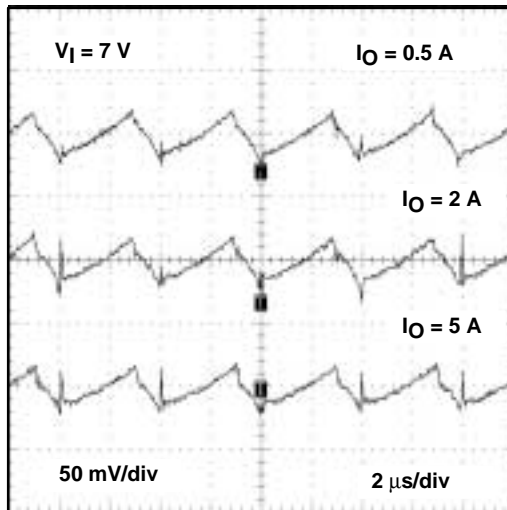

Figure 82

12 V OUTPUT VOLTAGE RIPPLE

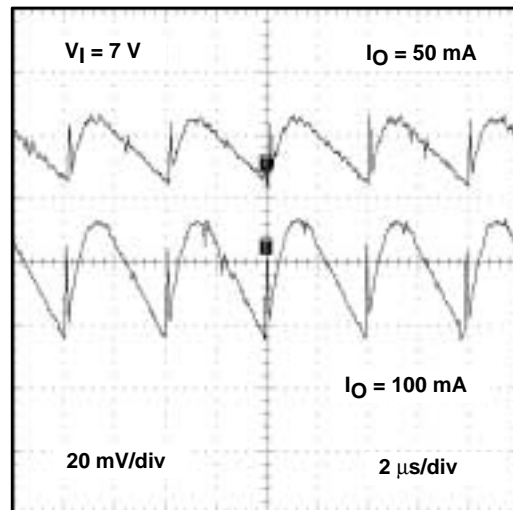

Figure 83

APPLICATION INFORMATION

2.5 V OUTPUT VOLTAGE
 LOAD TRANSIENT RESPONSE

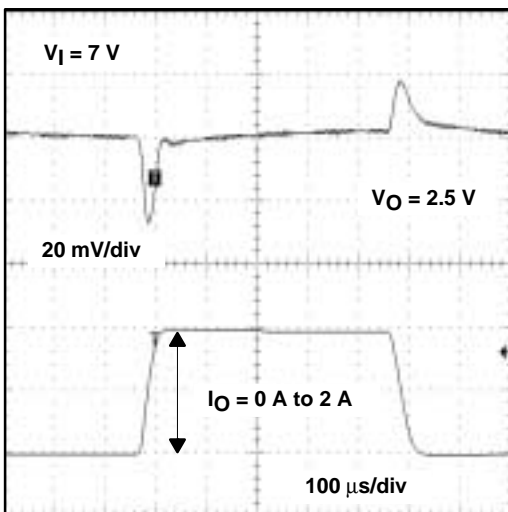

Figure 84

2.5 V OUTPUT VOLTAGE
 LOAD TRANSIENT RESPONSE

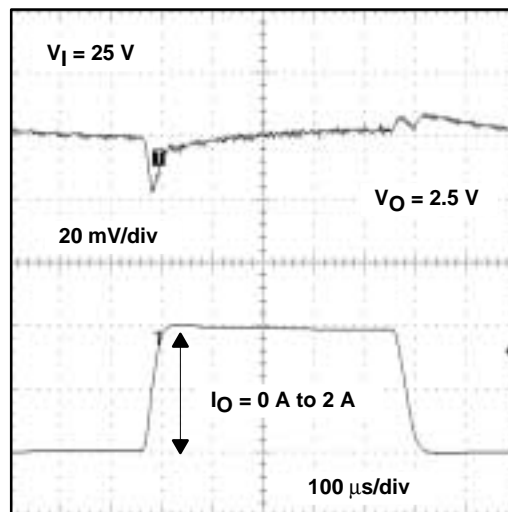

Figure 85

3.3 V OUTPUT VOLTAGE
 LOAD TRANSIENT RESPONSE

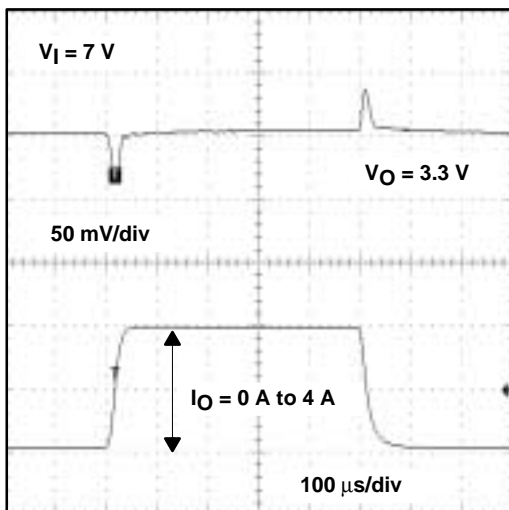

Figure 86

3.3 V OUTPUT VOLTAGE
 LOAD TRANSIENT RESPONSE

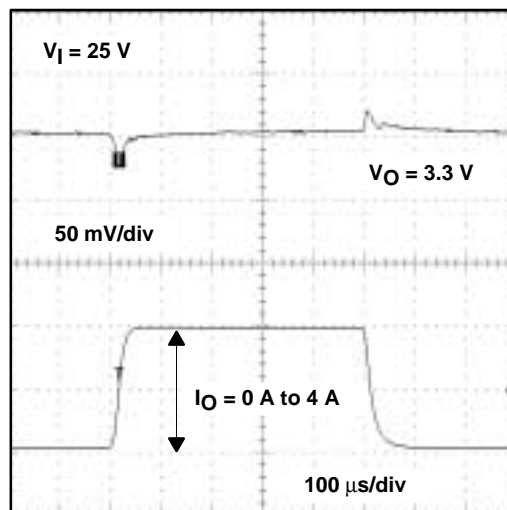

Figure 87

TPS5140 FOUR-CHANNEL DC/DC CONTROLLER FOR NOTEBOOK PC POWER

SLVS305A – DECEMBER 2000 – REVISED JANUARY 2001

APPLICATION INFORMATION

**5 V OUTPUT VOLTAGE
LOAD TRANSIENT RESPONSE**

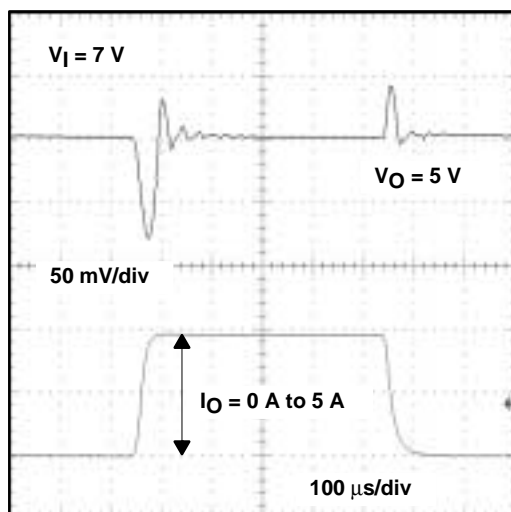

Figure 88

**5 V OUTPUT VOLTAGE
LOAD TRANSIENT RESPONSE**

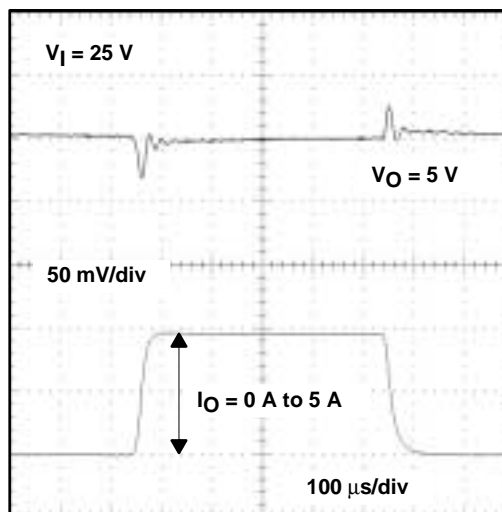

Figure 89

Table 4. Bill of Materials

REF.	PN	DESCRIPTION	MFG.	SIZE
C01	Open	Capacitor, electrolytic, 330 μ F, 35 V	Sanyo	10x10 mm
C02	Standard	Capacitor, ceramic, 2200 pF		805
C03	Standard	Capacitor, ceramic, 0.01 μ F		805
C04	Standard	Capacitor, ceramic, 56 pF		805
C05	Standard	Capacitor, ceramic, 0.1 μ F		805
C06	Standard	Capacitor, ceramic, 0.022 μ F		805
C07	Standard	Open		805
C08	Standard	Capacitor, ceramic, 0.01 μ F		805
C09	Standard	Capacitor, ceramic, 2200 pF		805
C10	Standard	Capacitor, ceramic, 1.0 μ F		805
C11A	10TPB220M	Capacitor, POSCAP, 220 μ F, 10 V	Sanyo	7.3x4.3 mm
C11B	Open	Open, Capacitor, POSCAP	Sanyo	7.3x4.3 mm
C12	Standard	Capacitor, ceramic, 0.1 μ F		805
C13	TMK325BJ475MN-B	Capacitor, ceramic, 4.7 μ F		1210 (3225)
C14	Standard	Capacitor, ceramic, 1.0 μ F		805
C15A	6TPB150M	Capacitor, POSCAP, 150 μ F, 6.3 V	Sanyo	7.3x4.3 mm
C15B	6TPB150M	Capacitor, POSCAP, 150 μ F, 6.3 V	Sanyo	7.3x4.3 mm
C16A	10TPB220M	Capacitor, POSCAP, 220 μ F, 10 V	Sanyo	7.3x4.3 mm
C16B	Open	Open, Capacitor, POSCAP	Sanyo	7.3x4.3 mm

TPS5140

FOUR-CHANNEL DC/DC CONTROLLER FOR NOTEBOOK PC POWER

SLVS305A – DECEMBER 2000 – REVISED JANUARY 2001

APPLICATION INFORMATION

Table 4. Bill of Materials (Continued)

REF.	PN	DESCRIPTION	MFG.	SIZE
C17	Standard	Capacitor, ceramic, 1.0 μ F		805
C18	Standard	Capacitor, ceramic, 2200 pF		805
C19	Standard	Capacitor, ceramic, 0.01 μ F		805
C20	TMK432BJ106MN	Capacitor, ceramic, 10 μ F, 25 V, X5R	Taiyo Yuden	1812 (432)
C21	TMK432BJ106MN	Capacitor, ceramic, 10 μ F, 25 V, X5R	Taiyo Yuden	1812 (432)
C22	Standard	Capacitor, ceramic, 0.01 μ F		805
C23	Standard	Open		805
C24	TMK432BJ106MN	Capacitor, ceramic, 10 μ F, 25 V, X5R	Taiyo Yuden	1812 (432)
C25	TMK432BJ106MN	Capacitor, ceramic, 10 μ F, 25 V, X5R	Taiyo Yuden	1812 (432)
C26	TMK432BJ106MN	Capacitor, ceramic, 10 μ F, 25 V, X5R	Taiyo Yuden	1812 (432)
C27	Standard	Capacitor, ceramic, 8200 pF		805
C28	Standard	Capacitor, ceramic, 8200 pF		805
C29	Standard	Capacitor, ceramic, 6800 pF		805
C30	Standard	Capacitor, ceramic, 0.1 μ F		805
C31	Standard	Capacitor, ceramic, 0.1 μ F		805
C32	Standard	Capacitor, ceramic, 0.1 μ F		805
D1	MBR0540T1	Diode, Schottky, 40 V, 500 mA	Motorola	3.7x1.6 mm
D2	MBR0540T1	Diode, Schottky, 40 V, 500 mA	Motorola	3.7x1.6 mm
D3	MBR0540T1	Diode, Schottky, 40 V, 500 mA	Motorola	3.7x1.6 mm
D4	RB160L-40-TE25	Diode, Schottky, 40 V, 1 A	Rohm	4.5x2.6 mm
D5	EC31QS04	Diode, Schottky, 40 V, 3 A	Nihon Inter	5.0x2.5 mm
D6	EC31QS04	Diode, Schottky, 40 V, 3 A	Nihon Inter	5.0x2.5 mm
D7	EC31QS04	Diode, Schottky, 40 V, 3 A	Nihon Inter	5.0x2.5 mm
JP00-JP06	WL-8	Header, straight, 3-pin	Mac8	
JP8	WL-8	Header, straight, 3-pin	Mac8	
JP00-JP06 shunt	JS-1	Jumper socket	Mac8	
JP8 shunt	JS-1	Jumper socket	Mac8	
L1	CDRH127-100	Inductor, 10 μ H, 5.4 A	Sumida	12x12 mm
L2	CDRH127-6R1	Inductor, 6.1 μ H, 6.6 A	Sumida	12x12 mm
L3	CDRH125-100	Inductor, 10 μ H, 4.0 A	Sumida	12x12 mm
L4	CDRH5D28-220	Inductor, 22 μ H, 0.9 A	Sumida	5.7x5.7 mm
R01A	Standard	Resistor, 15 k Ω , 1%		805
R01B	Standard	Resistor, 18 k Ω , 1%		805
R02A	Standard	Resistor, 10 k Ω , 1%		805
R02B	Standard	Open		805
R03	Standard	Resistor, 470 Ω , 5%		805
R04	Standard	Resistor, 470 Ω , 5%		805
R05A	Standard	Resistor, 10 k Ω , 1%		805
R05B	Standard	Open		805
R06A	Standard	Resistor, 1.8 k Ω , 1%		805
R06B	Standard	Resistor, 10 k Ω , 1%		805
R07	Standard	Resistor, 10 k Ω , 1%		805



TPS5140 FOUR-CHANNEL DC/DC CONTROLLER FOR NOTEBOOK PC POWER

SLVS305A – DECEMBER 2000 – REVISED JANUARY 2001

APPLICATION INFORMATION

Table 4. Bill of Materials (Continued)

REF.	PN	DESCRIPTION	MFG.	SIZE
R08	Standard	Resistor, 24 k Ω , 1%		805
R09	Standard	Resistor, 18 k Ω , 1%		805
R10A	Standard	Resistor, 2 k Ω , 1%		805
R10B	Standard	Resistor, 16 k Ω , 1%		805
R11A	Standard	Resistor, 10 k Ω , 1%		805
R11B	Standard	Open		805
R12	Standard	Resistor, 470 Ω , 5%		805
R13	Standard	Resistor, 100 k Ω , 5 %		805
R14	Standard	Open		805
R16	Standard	Resistor, 100 k Ω , 5 %		805
R17	Standard	Open		805
R19	Standard	Resistor, 15 Ω , 5 %		805
R22	Standard	Resistor, 15 Ω , 5 %		805
R24	Standard	Resistor, 15 Ω , 5 %		805
R25	Standard	Resistor, 220 Ω , 5 %		805
R26	Standard	Resistor, 470 Ω , 5 %		805
R27	Standard	Resistor, 100 Ω , 5 %		805
Q01–Q06	FDS6612A	Transistor, MOSFET, N–ch, 30 V, 8.4 A, 26 m Ω	Fairchild	SO–8
U1	TPS5140	IC, Quad controller	TI	TQFP

Table 5. Vendor and Source Information

MATERIAL	SOURCE	PART NUMBER	DISTRIBUTORS
MOSFETS (Q01– Q06)	In EVM design	FDS6612A (Fairchild)	Local Distributor
	Second source	IRF9410 (International Rectifier)	
MAIN DIODES (D5 – D7)	In EVM design	EC31QS04 (Nihon Inter)	81–3–3342–5407
CERAMIC CAPACITORS (C20, C21, C24 , C25, C26)	In EVM design	TMK432BJ106MN (Taiyo Yuden)	http://www.t-yuden.com http://www.yuden.co.jp
INDUCTORS (L1 – L4)	In EVM design	CDRH125–100 CDRH127–6R1 CDRH127–100 CDRH5D28–220 (Sumida)	http://www.sUmida.com



POST OFFICE BOX 655303 • DALLAS, TEXAS 75265

APPLICATION INFORMATION

EVM Layout

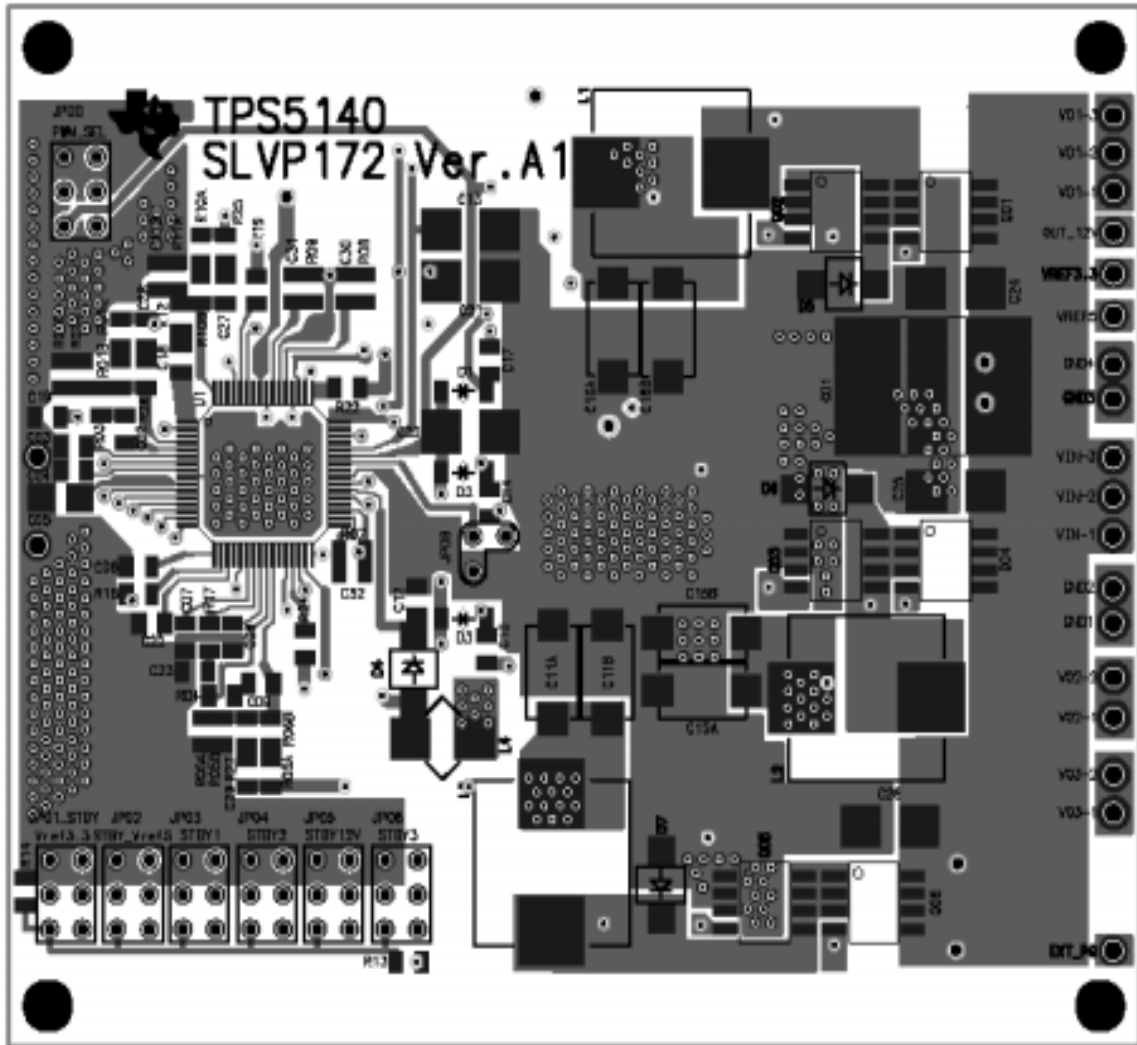

Top Layer

Figure 90. EVM Top Layer

TPS5140 FOUR-CHANNEL DC/DC CONTROLLER FOR NOTEBOOK PC POWER

SLVS305A – DECEMBER 2000 – REVISED JANUARY 2001

APPLICATION INFORMATION

EVM Layout (continued)

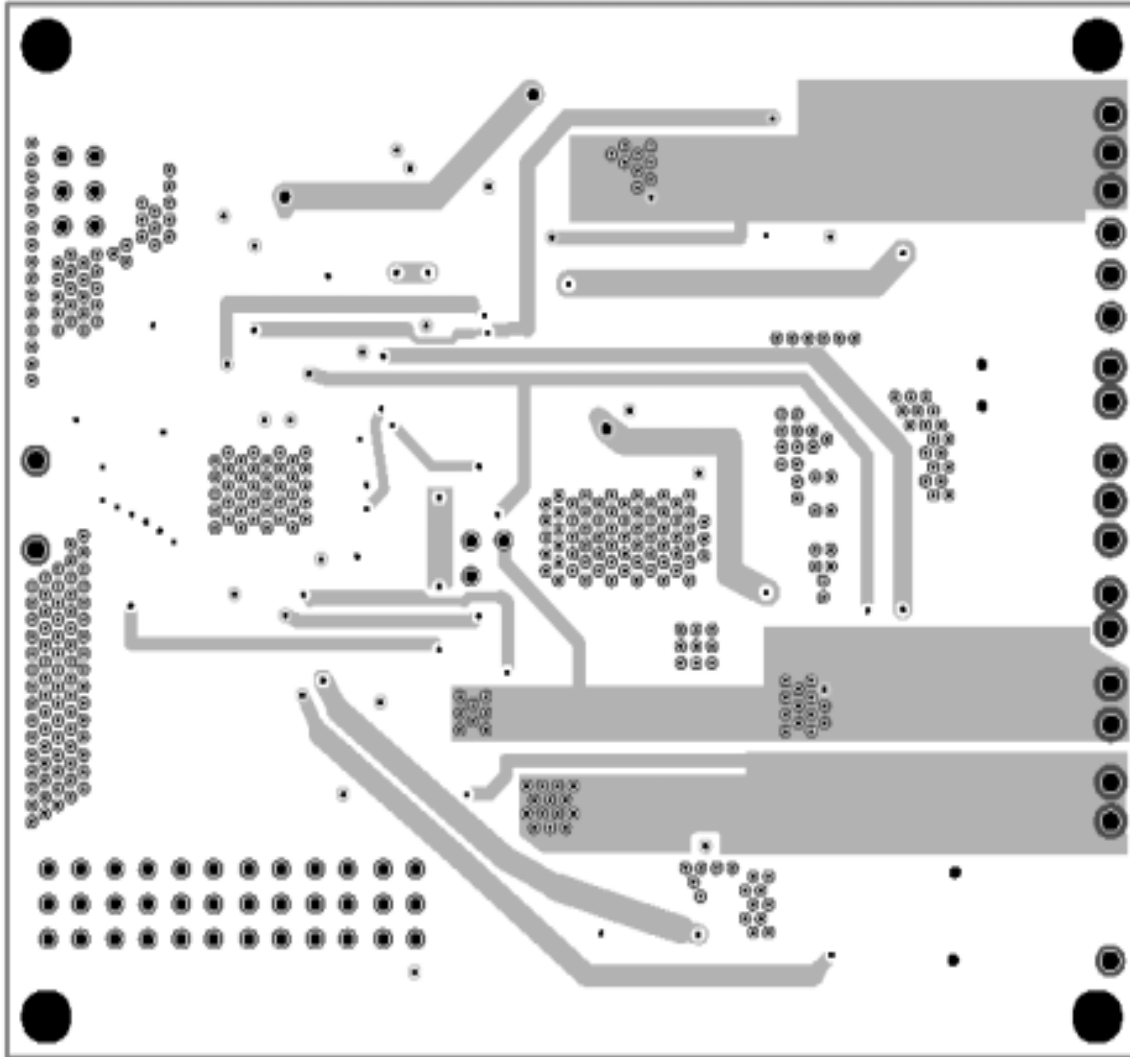

2nd Layer

Figure 91. EVM Second Layer

APPLICATION INFORMATION

EVM Layout (continued)

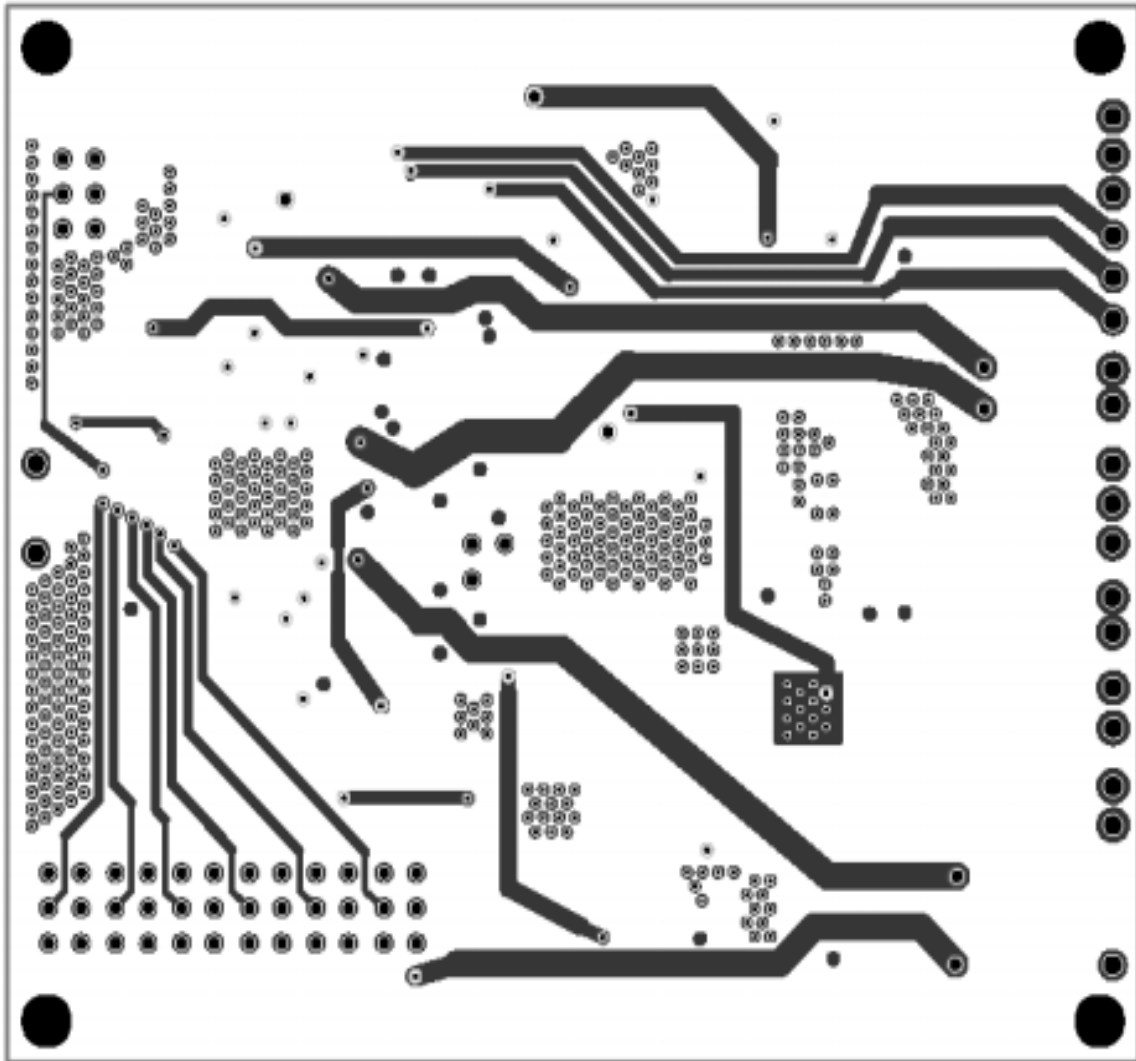

3rd Layer

Figure 92. EVM Third Layer

TPS5140 FOUR-CHANNEL DC/DC CONTROLLER FOR NOTEBOOK PC POWER

SLVS305A – DECEMBER 2000 – REVISED JANUARY 2001

APPLICATION INFORMATION

EVM Layout (continued)

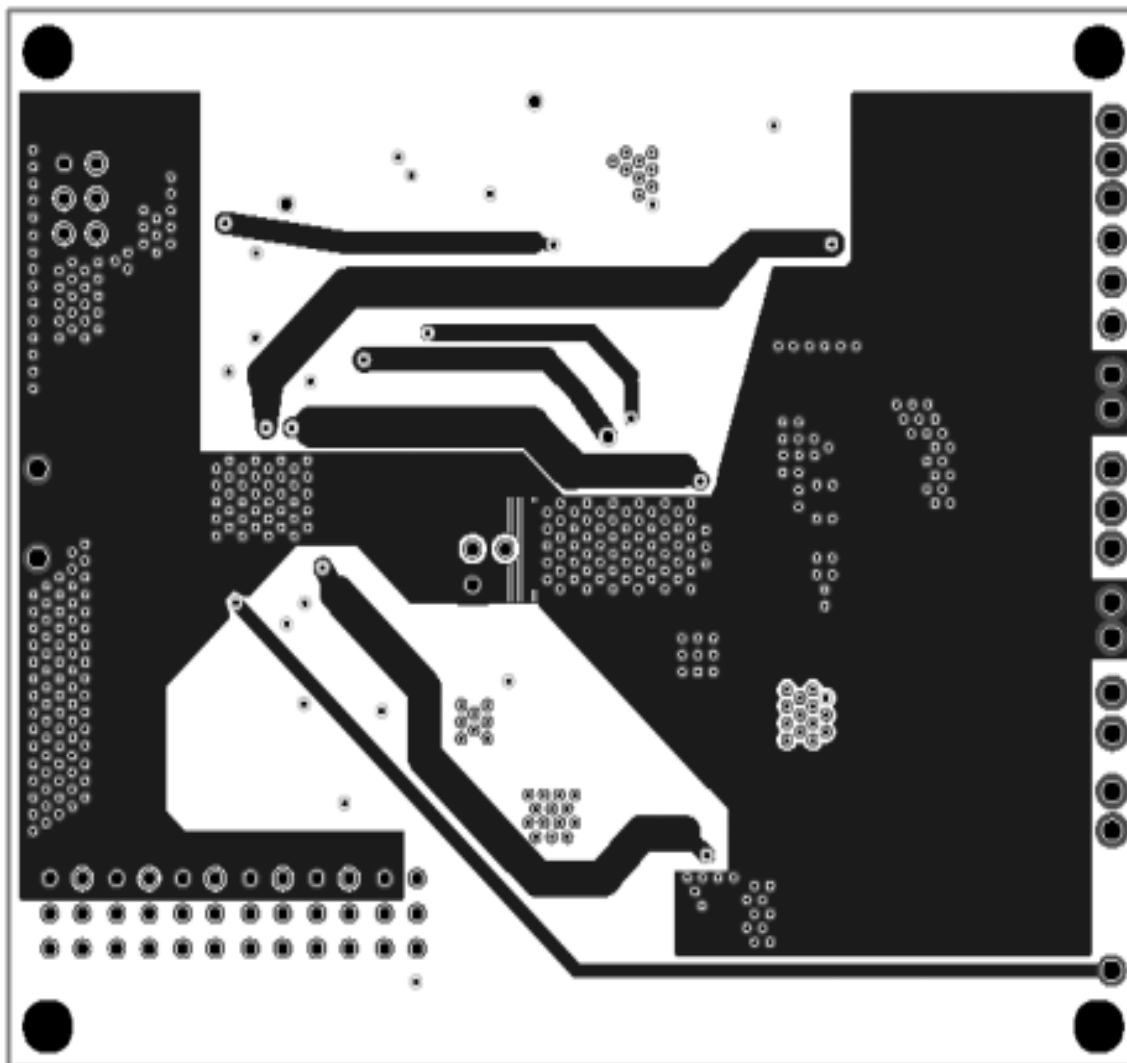

Bottom Layer (Top View)

Figure 93. EVM Bottom Layer (Top View)

TPS5140

FOUR-CHANNEL DC/DC CONTROLLER FOR NOTEBOOK PC POWER

SLVS305A – DECEMBER 2000 – REVISED JANUARY 2001

MECHANICAL DATA

PAG (S-PQFP-G64)

PLASTIC QUAD FLATPACK

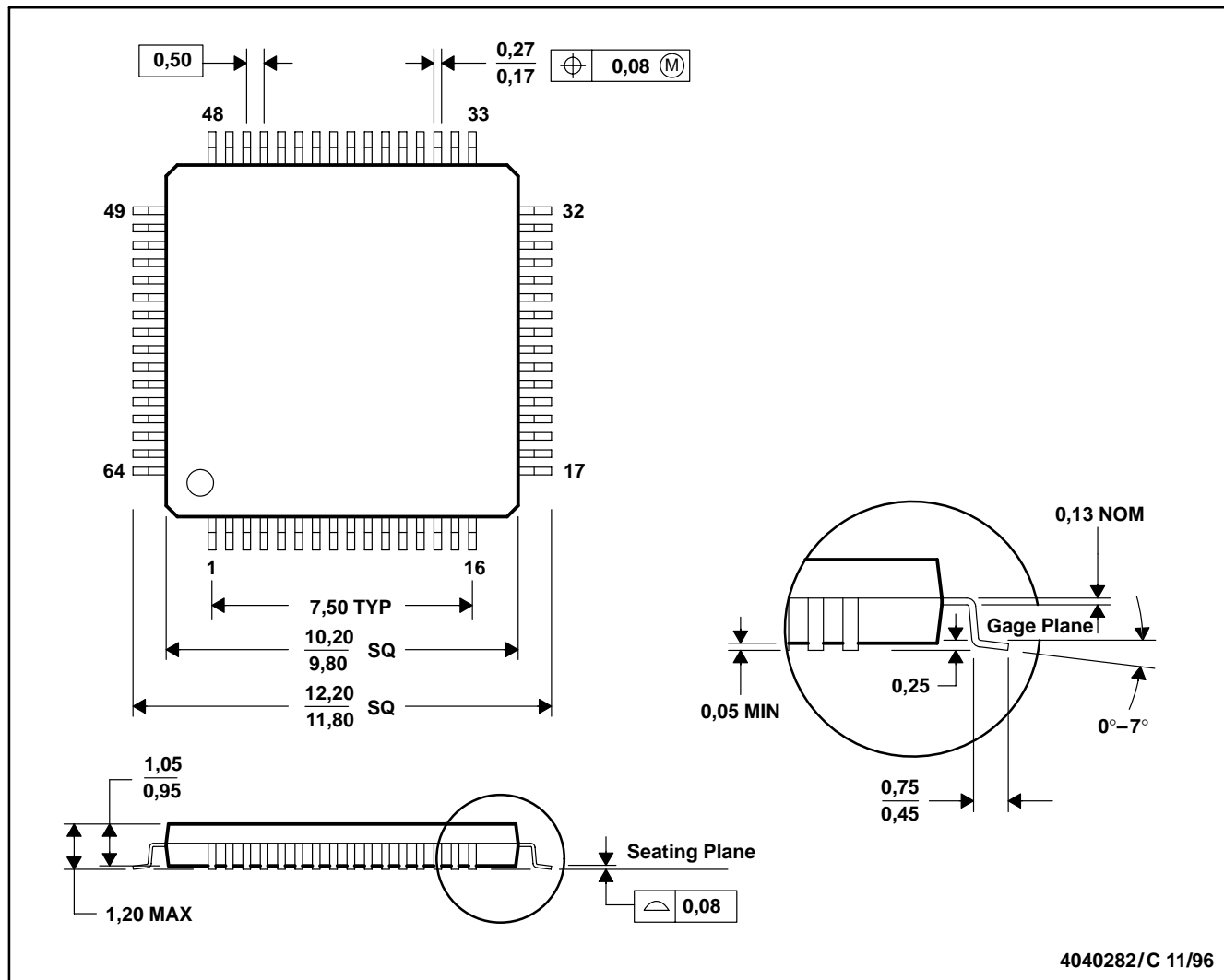

- NOTES: A. All linear dimensions are in millimeters.
 B. This drawing is subject to change without notice.
 C. Falls within JEDEC MS-026

PACKAGING INFORMATION

Orderable Device	Status ⁽¹⁾	Package Type	Package Drawing	Pins	Package Qty	Eco Plan ⁽²⁾	Lead/Ball Finish	MSL Peak Temp ⁽³⁾
TPS5140PAG	ACTIVE	TQFP	PAG	64	160	Green (RoHS & no Sb/Br)	CU NIPDAU	Level-4-260C-72 HR
TPS5140PAGG4	ACTIVE	TQFP	PAG	64	160	Green (RoHS & no Sb/Br)	CU NIPDAU	Level-4-260C-72 HR
TPS5140PAGR	ACTIVE	TQFP	PAG	64	1500	Green (RoHS & no Sb/Br)	CU NIPDAU	Level-4-260C-72 HR
TPS5140PAGRG4	ACTIVE	TQFP	PAG	64	1500	Green (RoHS & no Sb/Br)	CU NIPDAU	Level-4-260C-72 HR

⁽¹⁾ The marketing status values are defined as follows:

ACTIVE: Product device recommended for new designs.

LIFEBUY: TI has announced that the device will be discontinued, and a lifetime-buy period is in effect.

NRND: Not recommended for new designs. Device is in production to support existing customers, but TI does not recommend using this part in a new design.

PREVIEW: Device has been announced but is not in production. Samples may or may not be available.

OBSOLETE: TI has discontinued the production of the device.

⁽²⁾ Eco Plan - The planned eco-friendly classification: Pb-Free (RoHS), Pb-Free (RoHS Exempt), or Green (RoHS & no Sb/Br) - please check <http://www.ti.com/productcontent> for the latest availability information and additional product content details.

TBD: The Pb-Free/Green conversion plan has not been defined.

Pb-Free (RoHS): TI's terms "Lead-Free" or "Pb-Free" mean semiconductor products that are compatible with the current RoHS requirements for all 6 substances, including the requirement that lead not exceed 0.1% by weight in homogeneous materials. Where designed to be soldered at high temperatures, TI Pb-Free products are suitable for use in specified lead-free processes.

Pb-Free (RoHS Exempt): This component has a RoHS exemption for either 1) lead-based flip-chip solder bumps used between the die and package, or 2) lead-based die adhesive used between the die and leadframe. The component is otherwise considered Pb-Free (RoHS compatible) as defined above.

Green (RoHS & no Sb/Br): TI defines "Green" to mean Pb-Free (RoHS compatible), and free of Bromine (Br) and Antimony (Sb) based flame retardants (Br or Sb do not exceed 0.1% by weight in homogeneous material)

⁽³⁾ MSL, Peak Temp. -- The Moisture Sensitivity Level rating according to the JEDEC industry standard classifications, and peak solder temperature.

Important Information and Disclaimer:The information provided on this page represents TI's knowledge and belief as of the date that it is provided. TI bases its knowledge and belief on information provided by third parties, and makes no representation or warranty as to the accuracy of such information. Efforts are underway to better integrate information from third parties. TI has taken and continues to take reasonable steps to provide representative and accurate information but may not have conducted destructive testing or chemical analysis on incoming materials and chemicals. TI and TI suppliers consider certain information to be proprietary, and thus CAS numbers and other limited information may not be available for release.

In no event shall TI's liability arising out of such information exceed the total purchase price of the TI part(s) at issue in this document sold by TI to Customer on an annual basis.

TAPE AND REEL INFORMATION



QUADRANT ASSIGNMENTS FOR PIN 1 ORIENTATION IN TAPE



*All dimensions are nominal

Device	Package Type	Package Drawing	Pins	SPQ	Reel Diameter (mm)	Reel Width W1 (mm)	A0 (mm)	B0 (mm)	K0 (mm)	P1 (mm)	W (mm)	Pin1 Quadrant
TPS5140PAGR	TQFP	PAG	64	1500	330.0	24.4	13.0	13.0	1.5	16.0	24.0	Q2

TAPE AND REEL BOX DIMENSIONS



*All dimensions are nominal

Device	Package Type	Package Drawing	Pins	SPQ	Length (mm)	Width (mm)	Height (mm)
TPS5140PAGR	TQFP	PAG	64	1500	346.0	346.0	41.0

IMPORTANT NOTICE

Texas Instruments Incorporated and its subsidiaries (TI) reserve the right to make corrections, modifications, enhancements, improvements, and other changes to its products and services at any time and to discontinue any product or service without notice. Customers should obtain the latest relevant information before placing orders and should verify that such information is current and complete. All products are sold subject to TI's terms and conditions of sale supplied at the time of order acknowledgment.

TI warrants performance of its hardware products to the specifications applicable at the time of sale in accordance with TI's standard warranty. Testing and other quality control techniques are used to the extent TI deems necessary to support this warranty. Except where mandated by government requirements, testing of all parameters of each product is not necessarily performed.

TI assumes no liability for applications assistance or customer product design. Customers are responsible for their products and applications using TI components. To minimize the risks associated with customer products and applications, customers should provide adequate design and operating safeguards.

TI does not warrant or represent that any license, either express or implied, is granted under any TI patent right, copyright, mask work right, or other TI intellectual property right relating to any combination, machine, or process in which TI products or services are used. Information published by TI regarding third-party products or services does not constitute a license from TI to use such products or services or a warranty or endorsement thereof. Use of such information may require a license from a third party under the patents or other intellectual property of the third party, or a license from TI under the patents or other intellectual property of TI.

Reproduction of TI information in TI data books or data sheets is permissible only if reproduction is without alteration and is accompanied by all associated warranties, conditions, limitations, and notices. Reproduction of this information with alteration is an unfair and deceptive business practice. TI is not responsible or liable for such altered documentation. Information of third parties may be subject to additional restrictions.

Resale of TI products or services with statements different from or beyond the parameters stated by TI for that product or service voids all express and any implied warranties for the associated TI product or service and is an unfair and deceptive business practice. TI is not responsible or liable for any such statements.

TI products are not authorized for use in safety-critical applications (such as life support) where a failure of the TI product would reasonably be expected to cause severe personal injury or death, unless officers of the parties have executed an agreement specifically governing such use. Buyers represent that they have all necessary expertise in the safety and regulatory ramifications of their applications, and acknowledge and agree that they are solely responsible for all legal, regulatory and safety-related requirements concerning their products and any use of TI products in such safety-critical applications, notwithstanding any applications-related information or support that may be provided by TI. Further, Buyers must fully indemnify TI and its representatives against any damages arising out of the use of TI products in such safety-critical applications.

TI products are neither designed nor intended for use in military/aerospace applications or environments unless the TI products are specifically designated by TI as military-grade or "enhanced plastic." Only products designated by TI as military-grade meet military specifications. Buyers acknowledge and agree that any such use of TI products which TI has not designated as military-grade is solely at the Buyer's risk, and that they are solely responsible for compliance with all legal and regulatory requirements in connection with such use.

TI products are neither designed nor intended for use in automotive applications or environments unless the specific TI products are designated by TI as compliant with ISO/TS 16949 requirements. Buyers acknowledge and agree that, if they use any non-designated products in automotive applications, TI will not be responsible for any failure to meet such requirements.

Following are URLs where you can obtain information on other Texas Instruments products and application solutions:

Products

Amplifiers	amplifier.ti.com
Data Converters	dataconverter.ti.com
DSP	dsp.ti.com
Clocks and Timers	www.ti.com/clocks
Interface	interface.ti.com
Logic	logic.ti.com
Power Mgmt	power.ti.com
Microcontrollers	microcontroller.ti.com
RFID	www.ti-rfid.com
RF/IF and ZigBee® Solutions	www.ti.com/lprf

Applications

Audio	www.ti.com/audio
Automotive	www.ti.com/automotive
Broadband	www.ti.com/broadband
Digital Control	www.ti.com/digitalcontrol
Medical	www.ti.com/medical
Military	www.ti.com/military
Optical Networking	www.ti.com/opticalnetwork
Security	www.ti.com/security
Telephony	www.ti.com/telephony
Video & Imaging	www.ti.com/video
Wireless	www.ti.com/wireless

Mailing Address: Texas Instruments, Post Office Box 655303, Dallas, Texas 75265
Copyright © 2008, Texas Instruments Incorporated