

SN74AUC1G17 Single Schmitt-Trigger Buffer

1 Features

- Latch-Up Performance Exceeds 100 mA Per JESD 78, Class II
- ESD Protection Exceeds JESD 22
 - 2000-V Human-Body Model (A114-A)
 - 200-V Machine Model (A115-A)
 - 1000-V Charged-Device Model (C101)
- Available in the Texas Instruments NanoFree™ Package
- Optimized for 1.8-V Operation and Is 3.6-V I/O Tolerant to Support Mixed-Mode Signal Operation
- I_{off} Supports Partial Power Down Mode and Back Drive Protection
- Sub 1-V Operable
- Maximum t_{pd} of 2.4 ns at 1.8 V
- Low Power Consumption, 10- μ A Maximum I_{CC}
- ± 8 -mA Output Drive at 1.8 V

2 Applications

- AV Receiver
- Audio Dock: Portable
- Blu-Ray Player and Home Theater
- Embedded PC
- MP3 Player/Recorder (Portable Audio)
- Personal Digital Assistant (PDA)
- Power: Telecom/Server AC/DC Supply: Single Controller: Analog and Digital
- Solid State Drive (SSD): Client and Enterprise
- TV: LCD/Digital and High-Definition (HDTV)
- Tablet: Enterprise
- Video Analytics: Server
- Wireless Headset, Keyboard, and Mouse

3 Description

This single Schmitt-trigger buffer is operational at 0.8-V to 2.7-V V_{CC} , but is designed specifically for 1.65-V to 1.95-V V_{CC} operation.

The SN74AUC1G17 contains one buffer and performs the Boolean function $Y = A$. The device functions as an independent buffer, but because of Schmitt action, it may have different input threshold levels for positive-going (V_{T+}) and negative-going (V_{T-}) signals.

NanoFree™ package technology is a major breakthrough in IC packaging concepts, using the die as the package.

This device is fully specified for partial-power-down applications using I_{off} . The I_{off} circuitry disables the outputs, preventing damaging current backflow through the device when it is powered down.

For more information about AUC Little Logic devices, see [Applications of Texas Instruments AUC Sub-1-V Little Logic Devices](#), SCEA027.

Device Information⁽¹⁾

PART NUMBER	PACKAGE	BODY SIZE (NOM)
SN74AUC1G17DBV	SOT-23 (5)	2.90 mm x 1.60 mm
SN74AUC1G17DCK	SC70 (5)	2.00 mm x 1.25 mm
SN74AUC1G17DRL	SOT-5X3 (5)	1.60 mm x 1.20 mm
SN74AUC1G17YZP	DSBGA (5)	1.75 mm x 1.25 mm

(1) For all available packages, see the orderable addendum at the end of the data sheet.

Logic Diagram (Positive Logic)



Table of Contents

1 Features	1	6.8 Operating Characteristics.....	6
2 Applications	1	7 Parameter Measurement Information	7
3 Description	1	8 Detailed Description	8
4 Revision History	2	8.1 Functional Block Diagram	8
5 Pin Configuration and Functions	3	8.2 Device Functional Modes.....	8
6 Specifications	4	9 Device and Documentation Support	9
6.1 Absolute Maximum Ratings	4	9.1 Documentation Support	9
6.2 ESD Ratings.....	4	9.2 Receiving Notification of Documentation Updates....	9
6.3 Recommended Operating Conditions	4	9.3 Community Resources.....	9
6.4 Thermal Information	5	9.4 Trademarks	9
6.5 Electrical Characteristics.....	5	9.5 Electrostatic Discharge Caution.....	9
6.6 Switching Characteristics: $C_L = 15$ pF	6	9.6 Glossary	9
6.7 Switching Characteristics: $C_L = 30$ pF	6	10 Mechanical, Packaging, and Orderable Information	9

4 Revision History

NOTE: Page numbers for previous revisions may differ from page numbers in the current version.

Changes from Revision N (April 2007) to Revision O	Page
• Deleted DRY package throughout data sheet.....	1
• Added <i>Applications</i> , <i>Device Information</i> table, <i>Pin Configuration and Functions</i> , <i>ESD Ratings</i> table, <i>Thermal Information</i> table, <i>Feature Description</i> section, <i>Device Functional Modes</i> , <i>Device and Documentation Support</i> section, and <i>Mechanical, Packaging, and Orderable Information</i> section.....	1
• Deleted <i>Ordering Information</i> table, see <i>Mechanical, Packaging, and Orderable Information</i> at the end of the data sheet	1

5 Pin Configuration and Functions

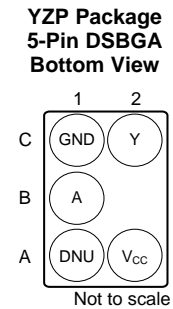
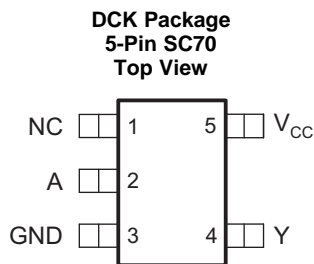
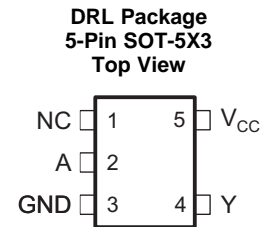
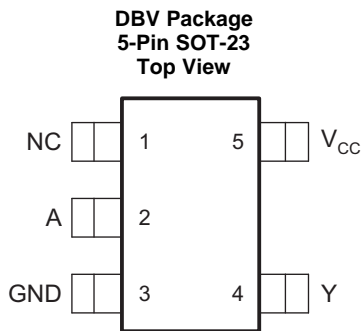

See mechanical drawings for dimensions.

NC – No internal connection

DNU – Do not use

Pin Functions

NAME	PIN		I/O	DESCRIPTION
	DBV, DCK, DRL	YZP		
A	2	B1	I	A logic input
DNU	—	A1	—	Do not use
GND	3	C1	—	Ground
NC	1	—	—	No internal connection
V _{CC}	5	A2	—	Positive supply
Y	4	C2	O	Y buffered output

6 Specifications

6.1 Absolute Maximum Ratings

 over operating free-air temperature range (unless otherwise noted)⁽¹⁾

		MIN	MAX	UNIT	
V _{CC}	Supply voltage	-0.5	3.6	V	
V _I	Input voltage ⁽²⁾	-0.5	3.6	V	
V _O	Voltage range applied to any output in the high impedance or power-off state ⁽²⁾	-0.5	3.6	V	
V _O	Output voltage ⁽²⁾	-0.5	V _{CC} + 0.5	V	
I _{IK}	Input clamp current	V _I < 0		-50	mA
I _{OK}	Output clamp current	V _O < 0		-50	mA
I _O	Continuous output current			±20	mA
	Continuous current through V _{CC} or GND			±100	mA
T _{stg}	Storage temperature	-65	150	°C	

- (1) Stresses beyond those listed under *Absolute Maximum Ratings* may cause permanent damage to the device. These are stress ratings only, which do not imply functional operation of the device at these or any other conditions beyond those indicated under *Recommended Operating Conditions*. Exposure to absolute-maximum-rated conditions for extended periods may affect device reliability.
- (2) The input negative-voltage and output voltage ratings may be exceeded if the input and output current ratings are observed.

6.2 ESD Ratings

		VALUE	UNIT
V _(ESD)	Electrostatic discharge	Human-body model (HBM), per ANSI/ESDA/JEDEC JS-001 ⁽¹⁾	2000
		Charged-device model (CDM), per JEDEC specification JESD22-C101 ⁽²⁾	1000
		Machine Model (A115-A)	200

- (1) JEDEC document JEP155 states that 500-V HBM allows safe manufacturing with a standard ESD control process.
- (2) JEDEC document JEP157 states that 250-V CDM allows safe manufacturing with a standard ESD control process.

6.3 Recommended Operating Conditions

 See⁽¹⁾

		MIN	MAX	UNIT
V _{CC}	Supply voltage	0.8	2.7	V
V _I	Input voltage	0	3.6	V
V _O	Output voltage	0	V _{CC}	V
I _{OH}	High-level output current	V _{CC} = 0.8 V		-0.7
		V _{CC} = 1.1 V		-3
		V _{CC} = 1.4 V		-5
		V _{CC} = 1.65 V		-8
		V _{CC} = 2.3 V		-9
I _{OL}	Low-level output current	V _{CC} = 0.8 V		0.7
		V _{CC} = 1.1 V		3
		V _{CC} = 1.4 V		5
		V _{CC} = 1.65 V		8
		V _{CC} = 2.3 V		9
T _A	Operating free-air temperature	-40	85	°C

- (1) All unused inputs of the device must be held at V_{CC} or GND to ensure proper device operation. See [Implications of Slow or Floating CMOS Inputs](#), SCBA004.

6.4 Thermal Information

THERMAL METRIC ⁽¹⁾	SN74AUC1G17				UNIT
	DBV (SOT-23)	DCK (SC70)	DRL (SOT-5X3)	YZP (DSBGA)	
	5 PINS	5 PINS	5 PINS	5 PINS	
R _{θJA} Junction-to-ambient thermal resistance	206	252	142	132	°C/W

(1) For more information about traditional and new thermal metrics, see the [Semiconductor and IC Package Thermal Metrics](#) application report.

6.5 Electrical Characteristics

over recommended operating free-air temperature range (unless otherwise noted)

PARAMETER	TEST CONDITIONS	V _{CC}	MIN TYP ⁽¹⁾ MAX	UNIT
V _{T+} Positive-going input threshold voltage		0.8 V	0.5	V
		1.1 V	0.51 0.86	
		1.4 V	0.65 1	
		1.65 V	0.79 1.16	
		2.3 V	1.11 1.56	
V _{T-} Negative-going input threshold voltage		0.8 V	0.3	V
		1.1 V	0.22 0.53	
		1.4 V	0.3 0.58	
		1.65 V	0.39 0.62	
		2.3 V	0.58 0.87	
ΔV _T Hysteresis (V _{T+} – V _{T-})		0.8 V	0.21	V
		1.1 V	0.25 0.38	
		1.4 V	0.31 0.5	
		1.65 V	0.37 0.62	
		2.3 V	0.48 0.77	
V _{OH}	I _{OH} = –100 μA	0.8 V to 2.7 V	V _{CC} – 0.1	V
	I _{OH} = –0.7 mA	0.8 V	0.55	
	I _{OH} = –3 mA	1.1 V	0.8	
	I _{OH} = –5 mA	1.4 V	1	
	I _{OH} = –8 mA	1.65 V	1.2	
	I _{OH} = –9 mA	2.3 V	1.8	
V _{OL}	I _{OL} = 100 μA	0.8 V to 2.7 V	0.2	V
	I _{OL} = 0.7 mA	0.8 V	0.25	
	I _{OL} = 3 mA	1.1 V	0.3	
	I _{OL} = 5 mA	1.4 V	0.4	
	I _{OL} = 8 mA	1.65 V	0.45	
	I _{OL} = 9 mA	2.3 V	0.6	
I _I A input	V _I = V _{CC} or GND	0 to 2.7 V	±5	μA
I _{off}	V _I or V _O = 2.7 V	0	±10	μA
I _{CC}	V _I = V _{CC} or GND, I _O = 0	0.8 V to 2.7 V	10	μA
C _i	V _I = V _{CC} or GND	2.5 V	3	pF

(1) All typical values are at T_A = 25°C.

SN74AUC1G17

SCES376O – SEPTEMBER 2001 – REVISED JUNE 2017

www.ti.com
6.6 Switching Characteristics: $C_L = 15$ pF

 over recommended operating free-air temperature range, $C_L = 15$ pF (unless otherwise noted) (see [Figure 1](#))

PARAMETER	FROM (INPUT)	TO (OUTPUT)	$V_{CC} = 0.8$ V	$V_{CC} = 1.2$ V ± 0.1 V		$V_{CC} = 1.5$ V ± 0.1 V		$V_{CC} = 1.8$ V ± 0.15 V			$V_{CC} = 2.5$ V ± 0.2 V		UNIT
			TYP	MIN	MAX	MIN	MAX	MIN	TYP	MAX	MIN	MAX	
t_{pd}	A	Y	5.7	0.8	3.9	0.7	2.1	0.6	1.1	1.9	0.5	1.5	ns

6.7 Switching Characteristics: $C_L = 30$ pF

 over recommended operating free-air temperature range, $C_L = 30$ pF (unless otherwise noted) (see [Figure 1](#))

PARAMETER	FROM (INPUT)	TO (OUTPUT)	$V_{CC} = 1.8$ V ± 0.15 V			$V_{CC} = 2.5$ V ± 0.2 V		UNIT
			MIN	TYP	MAX	MIN	MAX	
t_{pd}	A	Y	0.8	1.4	2.4	0.7	2.5	ns

6.8 Operating Characteristics
 $T_A = 25^\circ\text{C}$

PARAMETER	TEST CONDITIONS	$V_{CC} = 0.8$ V	$V_{CC} = 1.2$ V	$V_{CC} = 1.5$ V	$V_{CC} = 1.8$ V	$V_{CC} = 2.5$ V	UNIT	
		TYP	TYP	TYP	TYP	TYP		
C_{pd}	Power dissipation capacitance	f = 10 MHz	15	15	16	16	20	pF

7 Parameter Measurement Information

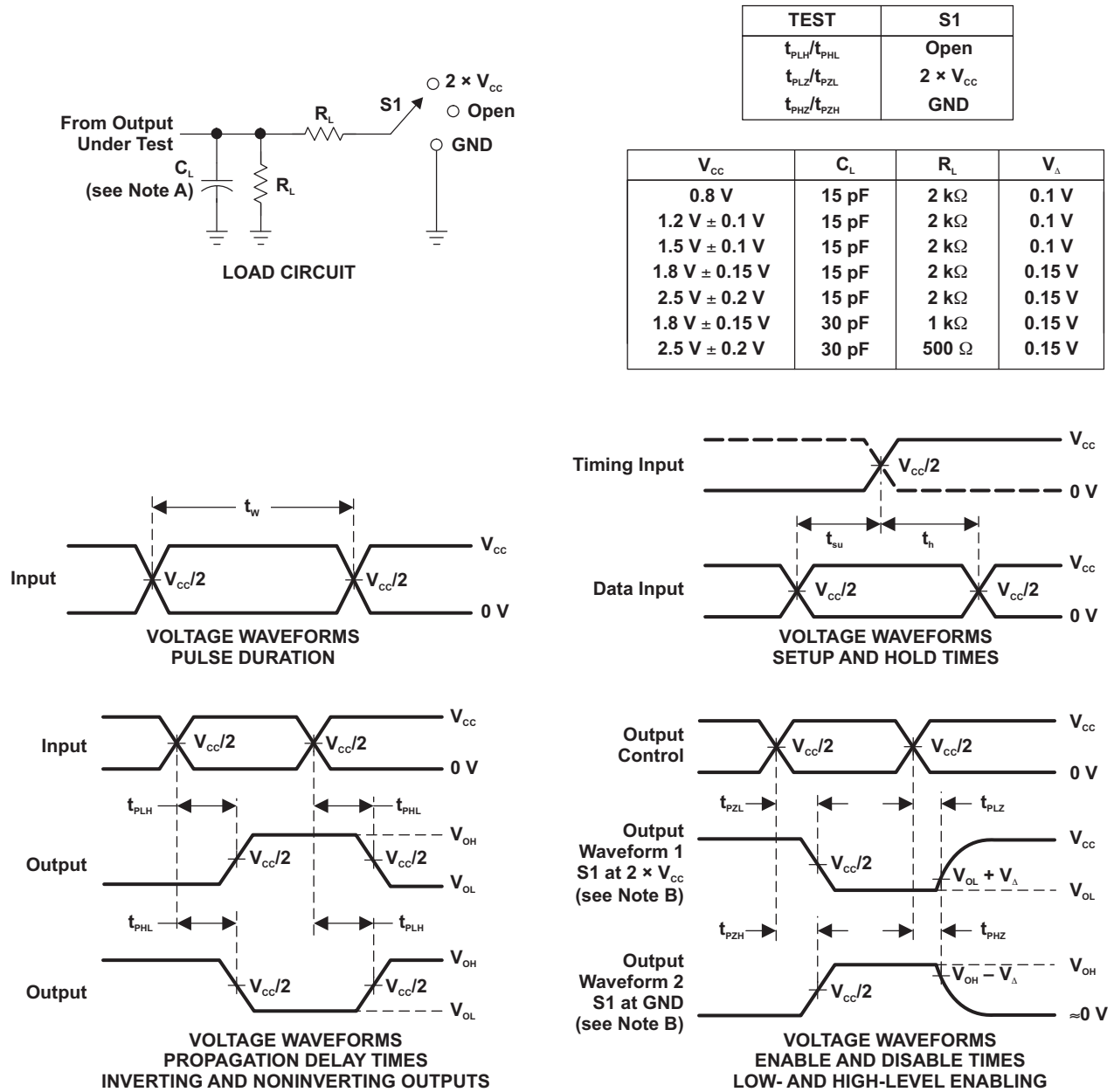

- NOTES: A. C_L includes probe and jig capacitance.
 B. Waveform 1 is for an output with internal conditions such that the output is low, except when disabled by the output control. Waveform 2 is for an output with internal conditions such that the output is high, except when disabled by the output control.
 C. All input pulses are supplied by generators having the following characteristics: PRR \leq 10 MHz, $Z_o = 50 \Omega$, slew rate ≥ 1 V/ns.
 D. The outputs are measured one at a time, with one transition per measurement.
 E. t_{PLZ} and t_{PHZ} are the same as t_{dis} .
 F. t_{PZL} and t_{PZH} are the same as t_{en} .
 G. t_{PLH} and t_{PHL} are the same as t_{pd} .
 H. All parameters and waveforms are not applicable to all devices.

Figure 1. Load Circuit and Voltage Waveforms

8 Detailed Description

8.1 Functional Block Diagram

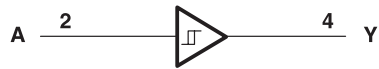

Figure 2. Logic Diagram (Positive Logic)

8.2 Device Functional Modes

[Table 1](#) lists the functional modes of the SN74AUC1G17.

Table 1. Function Table

INPUT A	OUTPUT Y
H	H
L	L

9 Device and Documentation Support

9.1 Documentation Support

9.1.1 Related Documentation

For related documentation see the following:

- [Applications of Texas Instruments AUC Sub-1-V Little Logic Devices](#), SCEA027
- [Implications of Slow or Floating CMOS Inputs](#), SCBA004

9.2 Receiving Notification of Documentation Updates

To receive notification of documentation updates, navigate to the device product folder on ti.com. In the upper right corner, click on *Alert me* to register and receive a weekly digest of any product information that has changed. For change details, review the revision history included in any revised document.

9.3 Community Resources

The following links connect to TI community resources. Linked contents are provided "AS IS" by the respective contributors. They do not constitute TI specifications and do not necessarily reflect TI's views; see TI's [Terms of Use](#).

TI E2E™ Online Community *TI's Engineer-to-Engineer (E2E) Community*. Created to foster collaboration among engineers. At e2e.ti.com, you can ask questions, share knowledge, explore ideas and help solve problems with fellow engineers.

Design Support *TI's Design Support* Quickly find helpful E2E forums along with design support tools and contact information for technical support.

9.4 Trademarks

NanoFree, E2E are trademarks of Texas Instruments.
All other trademarks are the property of their respective owners.

9.5 Electrostatic Discharge Caution



This integrated circuit can be damaged by ESD. Texas Instruments recommends that all integrated circuits be handled with appropriate precautions. Failure to observe proper handling and installation procedures can cause damage.

ESD damage can range from subtle performance degradation to complete device failure. Precision integrated circuits may be more susceptible to damage because very small parametric changes could cause the device not to meet its published specifications.

9.6 Glossary

SLYZ022 — *TI Glossary*.

This glossary lists and explains terms, acronyms, and definitions.

10 Mechanical, Packaging, and Orderable Information

The following pages include mechanical, packaging, and orderable information. This information is the most current data available for the designated devices. This data is subject to change without notice and revision of this document. For browser-based versions of this data sheet, refer to the left-hand navigation.

PACKAGING INFORMATION

Orderable Device	Status (1)	Package Type	Package Drawing	Pins	Package Qty	Eco Plan (2)	Lead finish/ Ball material (6)	MSL Peak Temp (3)	Op Temp (°C)	Device Marking (4/5)	Samples
SN74AUC1G17DBVR	ACTIVE	SOT-23	DBV	5	3000	RoHS & Green	NIPDAU SN	Level-1-260C-UNLIM	-40 to 85	(U175, U17F, U17K, U17R)	Samples
SN74AUC1G17DBVRG4	ACTIVE	SOT-23	DBV	5	3000	RoHS & Green	NIPDAU	Level-1-260C-UNLIM	-40 to 85	U17F	Samples
SN74AUC1G17DCKR	ACTIVE	SC70	DCK	5	3000	RoHS & Green	NIPDAU	Level-1-260C-UNLIM	-40 to 85	(U75, U7F, U7K, U7R)	Samples
SN74AUC1G17DRLR	ACTIVE	SOT-5X3	DRL	5	4000	RoHS & Green	NIPDAU NIPDAUAG	Level-1-260C-UNLIM	-40 to 85	(U77, U7R)	Samples
SN74AUC1G17YZPR	ACTIVE	DSBGA	YZP	5	3000	RoHS & Green	SNAGCU	Level-1-260C-UNLIM	-40 to 85	U7N	Samples

(1) The marketing status values are defined as follows:

ACTIVE: Product device recommended for new designs.

LIFEBUY: TI has announced that the device will be discontinued, and a lifetime-buy period is in effect.

NRND: Not recommended for new designs. Device is in production to support existing customers, but TI does not recommend using this part in a new design.

PREVIEW: Device has been announced but is not in production. Samples may or may not be available.

OBSOLETE: TI has discontinued the production of the device.

(2) **RoHS:** TI defines "RoHS" to mean semiconductor products that are compliant with the current EU RoHS requirements for all 10 RoHS substances, including the requirement that RoHS substance do not exceed 0.1% by weight in homogeneous materials. Where designed to be soldered at high temperatures, "RoHS" products are suitable for use in specified lead-free processes. TI may reference these types of products as "Pb-Free".

RoHS Exempt: TI defines "RoHS Exempt" to mean products that contain lead but are compliant with EU RoHS pursuant to a specific EU RoHS exemption.

Green: TI defines "Green" to mean the content of Chlorine (Cl) and Bromine (Br) based flame retardants meet JS709B low halogen requirements of <=1000ppm threshold. Antimony trioxide based flame retardants must also meet the <=1000ppm threshold requirement.

(3) MSL, Peak Temp. - The Moisture Sensitivity Level rating according to the JEDEC industry standard classifications, and peak solder temperature.

(4) There may be additional marking, which relates to the logo, the lot trace code information, or the environmental category on the device.

(5) Multiple Device Markings will be inside parentheses. Only one Device Marking contained in parentheses and separated by a "~" will appear on a device. If a line is indented then it is a continuation of the previous line and the two combined represent the entire Device Marking for that device.

(6) Lead finish/Ball material - Orderable Devices may have multiple material finish options. Finish options are separated by a vertical ruled line. Lead finish/Ball material values may wrap to two lines if the finish value exceeds the maximum column width.

Important Information and Disclaimer: The information provided on this page represents TI's knowledge and belief as of the date that it is provided. TI bases its knowledge and belief on information provided by third parties, and makes no representation or warranty as to the accuracy of such information. Efforts are underway to better integrate information from third parties. TI has taken and continues to take reasonable steps to provide representative and accurate information but may not have conducted destructive testing or chemical analysis on incoming materials and chemicals. TI and TI suppliers consider certain information to be proprietary, and thus CAS numbers and other limited information may not be available for release.

In no event shall TI's liability arising out of such information exceed the total purchase price of the TI part(s) at issue in this document sold by TI to Customer on an annual basis.

TAPE AND REEL INFORMATION

QUADRANT ASSIGNMENTS FOR PIN 1 ORIENTATION IN TAPE

*All dimensions are nominal

Device	Package Type	Package Drawing	Pins	SPQ	Reel Diameter (mm)	Reel Width W1 (mm)	A0 (mm)	B0 (mm)	K0 (mm)	P1 (mm)	W (mm)	Pin1 Quadrant
SN74AUC1G17DBVR	SOT-23	DBV	5	3000	178.0	9.0	3.23	3.17	1.37	4.0	8.0	Q3
SN74AUC1G17DBVR	SOT-23	DBV	5	3000	180.0	8.4	3.23	3.17	1.37	4.0	8.0	Q3
SN74AUC1G17DBVRG4	SOT-23	DBV	5	3000	178.0	9.0	3.23	3.17	1.37	4.0	8.0	Q3
SN74AUC1G17DCKR	SC70	DCK	5	3000	178.0	9.0	2.4	2.5	1.2	4.0	8.0	Q3
SN74AUC1G17DCKR	SC70	DCK	5	3000	180.0	8.4	2.47	2.3	1.25	4.0	8.0	Q3
SN74AUC1G17DCKR	SC70	DCK	5	3000	178.0	9.2	2.4	2.4	1.22	4.0	8.0	Q3
SN74AUC1G17DRLR	SOT-5X3	DRL	5	4000	180.0	9.5	1.78	1.78	0.69	4.0	8.0	Q3
SN74AUC1G17DRLR	SOT-5X3	DRL	5	4000	180.0	8.4	1.98	1.78	0.69	4.0	8.0	Q3
SN74AUC1G17YZPR	DSBGA	YZP	5	3000	178.0	9.2	1.02	1.52	0.63	4.0	8.0	Q1

TAPE AND REEL BOX DIMENSIONS

*All dimensions are nominal

Device	Package Type	Package Drawing	Pins	SPQ	Length (mm)	Width (mm)	Height (mm)
SN74AUC1G17DBVR	SOT-23	DBV	5	3000	180.0	180.0	18.0
SN74AUC1G17DBVR	SOT-23	DBV	5	3000	202.0	201.0	28.0
SN74AUC1G17DBVRG4	SOT-23	DBV	5	3000	180.0	180.0	18.0
SN74AUC1G17DCKR	SC70	DCK	5	3000	180.0	180.0	18.0
SN74AUC1G17DCKR	SC70	DCK	5	3000	202.0	201.0	28.0
SN74AUC1G17DCKR	SC70	DCK	5	3000	180.0	180.0	18.0
SN74AUC1G17DRLR	SOT-5X3	DRL	5	4000	184.0	184.0	19.0
SN74AUC1G17DRLR	SOT-5X3	DRL	5	4000	202.0	201.0	28.0
SN74AUC1G17YZPR	DSBGA	YZP	5	3000	220.0	220.0	35.0

DBV0005A



PACKAGE OUTLINE

SOT-23 - 1.45 mm max height

SMALL OUTLINE TRANSISTOR



4214839/E 09/2019

NOTES:

1. All linear dimensions are in millimeters. Any dimensions in parenthesis are for reference only. Dimensioning and tolerancing per ASME Y14.5M.
2. This drawing is subject to change without notice.
3. Reference JEDEC MO-178.
4. Body dimensions do not include mold flash, protrusions, or gate burrs. Mold flash, protrusions, or gate burrs shall not exceed 0.15 mm per side.

EXAMPLE BOARD LAYOUT

DBV0005A

SOT-23 - 1.45 mm max height

SMALL OUTLINE TRANSISTOR



LAND PATTERN EXAMPLE
EXPOSED METAL SHOWN
SCALE:15X



SOLDER MASK DETAILS

4214839/E 09/2019

NOTES: (continued)

- 5. Publication IPC-7351 may have alternate designs.
- 6. Solder mask tolerances between and around signal pads can vary based on board fabrication site.

EXAMPLE STENCIL DESIGN

DBV0005A

SOT-23 - 1.45 mm max height

SMALL OUTLINE TRANSISTOR



SOLDER PASTE EXAMPLE
BASED ON 0.125 mm THICK STENCIL
SCALE:15X

4214839/E 09/2019

NOTES: (continued)

7. Laser cutting apertures with trapezoidal walls and rounded corners may offer better paste release. IPC-7525 may have alternate design recommendations.
8. Board assembly site may have different recommendations for stencil design.

YZP0005



PACKAGE OUTLINE
DSBGA - 0.5 mm max height

DIE SIZE BALL GRID ARRAY

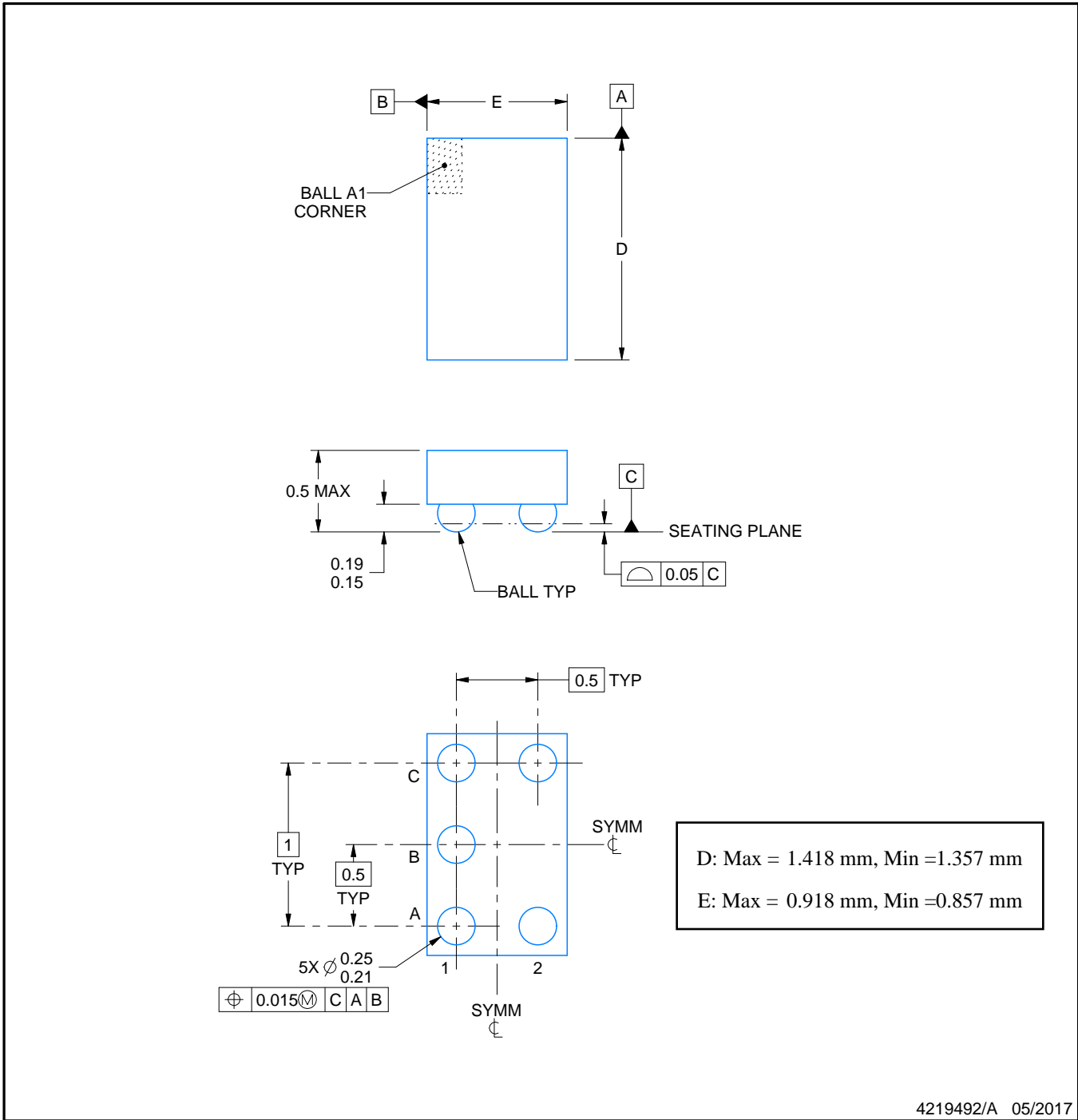

4219492/A 05/2017

NOTES:

1. All linear dimensions are in millimeters. Any dimensions in parenthesis are for reference only. Dimensioning and tolerancing per ASME Y14.5M.
2. This drawing is subject to change without notice.

EXAMPLE BOARD LAYOUT

YZP0005

DSBGA - 0.5 mm max height

DIE SIZE BALL GRID ARRAY



LAND PATTERN EXAMPLE
SCALE:40X



SOLDER MASK DETAILS
NOT TO SCALE

4219492/A 05/2017

NOTES: (continued)

3. Final dimensions may vary due to manufacturing tolerance considerations and also routing constraints. For more information, see Texas Instruments literature number SNVA009 (www.ti.com/lit/snva009).

EXAMPLE STENCIL DESIGN

YZP0005

DSBGA - 0.5 mm max height

DIE SIZE BALL GRID ARRAY



SOLDER PASTE EXAMPLE
BASED ON 0.1 mm THICK STENCIL
SCALE:40X

4219492/A 05/2017

NOTES: (continued)

4. Laser cutting apertures with trapezoidal walls and rounded corners may offer better paste release.

DRL0005A

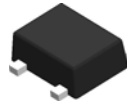

PACKAGE OUTLINE

SOT - 0.6 mm max height

PLASTIC SMALL OUTLINE



4220753/B 12/2020

NOTES:

1. All linear dimensions are in millimeters. Any dimensions in parenthesis are for reference only. Dimensioning and tolerancing per ASME Y14.5M.
2. This drawing is subject to change without notice.
3. This dimension does not include mold flash, protrusions, or gate burrs. Mold flash, protrusions, or gate burrs shall not exceed 0.15 mm per side.
4. Reference JEDEC registration MO-293 Variation UAAD-1

EXAMPLE BOARD LAYOUT

DRL0005A

SOT - 0.6 mm max height

PLASTIC SMALL OUTLINE

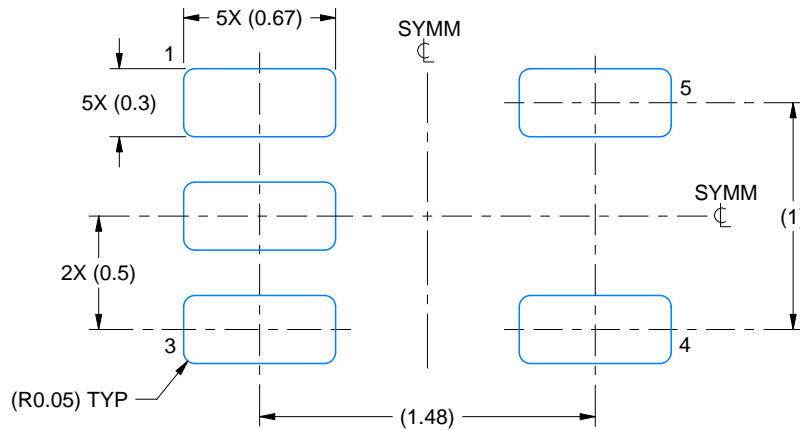

LAND PATTERN EXAMPLE
SCALE:30X



SOLDERMASK DETAILS

4220753/B 12/2020

NOTES: (continued)

- 5. Publication IPC-7351 may have alternate designs.
- 6. Solder mask tolerances between and around signal pads can vary based on board fabrication site.

EXAMPLE STENCIL DESIGN

DRL0005A

SOT - 0.6 mm max height

PLASTIC SMALL OUTLINE



SOLDER PASTE EXAMPLE
BASED ON 0.1 mm THICK STENCIL
SCALE:30X

4220753/B 12/2020

NOTES: (continued)

7. Laser cutting apertures with trapezoidal walls and rounded corners may offer better paste release. IPC-7525 may have alternate design recommendations.
8. Board assembly site may have different recommendations for stencil design.

DCK (R-PDSO-G5)

PLASTIC SMALL-OUTLINE PACKAGE



- NOTES:
- A. All linear dimensions are in millimeters.
 - B. This drawing is subject to change without notice.
 - C. Body dimensions do not include mold flash or protrusion. Mold flash and protrusion shall not exceed 0.15 per side.
 - D. Falls within JEDEC MO-203 variation AA.

DCK (R-PDSO-G5)

PLASTIC SMALL OUTLINE



- NOTES:
- All linear dimensions are in millimeters.
 - This drawing is subject to change without notice.
 - Customers should place a note on the circuit board fabrication drawing not to alter the center solder mask defined pad.
 - Publication IPC-7351 is recommended for alternate designs.
 - Laser cutting apertures with trapezoidal walls and also rounding corners will offer better paste release. Customers should contact their board assembly site for stencil design recommendations. Example stencil design based on a 50% volumetric metal load solder paste. Refer to IPC-7525 for other stencil recommendations.

IMPORTANT NOTICE AND DISCLAIMER

TI PROVIDES TECHNICAL AND RELIABILITY DATA (INCLUDING DATASHEETS), DESIGN RESOURCES (INCLUDING REFERENCE DESIGNS), APPLICATION OR OTHER DESIGN ADVICE, WEB TOOLS, SAFETY INFORMATION, AND OTHER RESOURCES "AS IS" AND WITH ALL FAULTS, AND DISCLAIMS ALL WARRANTIES, EXPRESS AND IMPLIED, INCLUDING WITHOUT LIMITATION ANY IMPLIED WARRANTIES OF MERCHANTABILITY, FITNESS FOR A PARTICULAR PURPOSE OR NON-INFRINGEMENT OF THIRD PARTY INTELLECTUAL PROPERTY RIGHTS.

These resources are intended for skilled developers designing with TI products. You are solely responsible for (1) selecting the appropriate TI products for your application, (2) designing, validating and testing your application, and (3) ensuring your application meets applicable standards, and any other safety, security, or other requirements. These resources are subject to change without notice. TI grants you permission to use these resources only for development of an application that uses the TI products described in the resource. Other reproduction and display of these resources is prohibited. No license is granted to any other TI intellectual property right or to any third party intellectual property right. TI disclaims responsibility for, and you will fully indemnify TI and its representatives against, any claims, damages, costs, losses, and liabilities arising out of your use of these resources.

TI's products are provided subject to TI's Terms of Sale (<https://www.ti.com/legal/termsofsale.html>) or other applicable terms available either on [ti.com](https://www.ti.com) or provided in conjunction with such TI products. TI's provision of these resources does not expand or otherwise alter TI's applicable warranties or warranty disclaimers for TI products.

Mailing Address: Texas Instruments, Post Office Box 655303, Dallas, Texas 75265
Copyright © 2021, Texas Instruments Incorporated