

General Description

The TD8210 is a fixed switching frequency (1.5MHz typical), current-mode, step-up regulator with an integrated N-channel MOSFET. The device allows the usage of small inductors and output capacitors for portable devices. The current-mode control scheme provides fast transient response and good output voltage accuracy.

The TD8210 includes under-voltage lockout, current limit, and over-temperature shutdown preventing damage in the event of an output overload.

Features

- Wide 2.7V to 6V Input Voltage Range
- Built-in 0.2Ω N-Channel MOSFET
- Built-in Soft-Start
- High Efficiency up to 90%
- <1mA Quiescent Current During Shutdown
- Current-Mode Operation
- Stable with Ceramic Output Capacitors
- Fast Transient Response
- Current-Limit Protection
- Over-Temperature Protection with Hysteresis
- Available in a SOT-23-5A and TDFN2x2-6 Package
- Lead Free and Green Devices Available
- (RoHS Compliant)

Applications

- Cell Phone and Smart Phone
- PDA, PMP, MP3
- Digital Camera
- Boost Regulators

Package Types

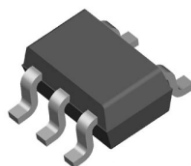

SOT23-5

Figure 1. Package Types of TD8210

Pin Configurations

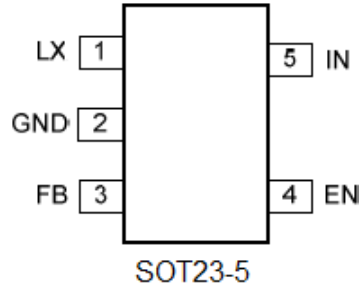
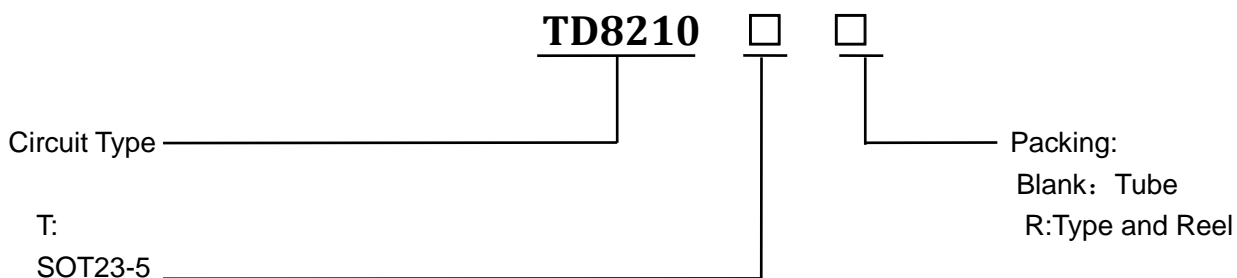

Figure 2 Pin Configuration of TD8210(Top View)

Pin Description

Pin Number	Pin Name	Description
1	LX	Switch pin. Connect this pin to inductor/diode here.
2	GDN	GND
3	FB	Feedback Input. The device senses feedback voltage via FB and regulate the voltage at 1.23V. Connecting FB with a resistor-divider from the output that sets the output voltage.
4	EN	Enable Control Input. Forcing this pin above 1.0V enables the device. Forcing this pin below 0.4V to shut it down. In shutdown, all functions are disabled to decrease the supply current below 1µA. Do not left this pin floating.
5	IN	Main Supply Pin. Must be closely decoupled to GND with a 2.2µF or greater ceramic capacitor.

Ordering Information



Function Block

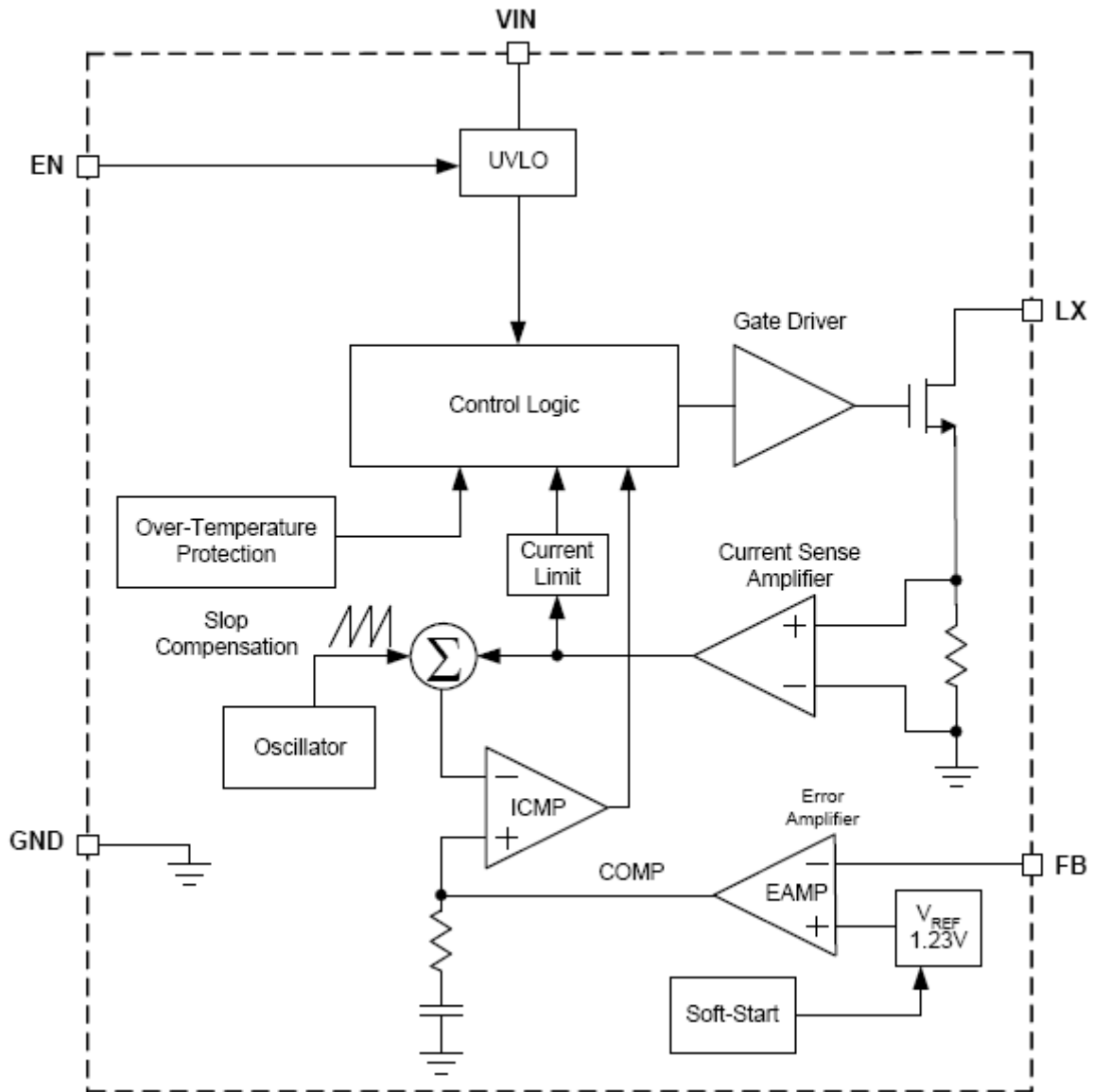

Figure 3 Function Block Diagram of TD8210

Absolute Maximum Ratings

Symbol	Parameter	Rating	Unit
V _{IN}	VIN Pin to GND	-0.3 to 7	V
V _{LX}	LX Pin to GND	-0.3 to 30	V
V _{EN}	EN Pin to GND	-0.3 to V _{IN}	V
T _J	Maximum Junction Temperature	150	°C
T _{STG}	Storage Temperature Range	-65 to 150	°C
T _{SOL}	Maximum Lead Soldering Temperature, 10 Seconds	260	°C

Note1: Stresses beyond those listed under "absolute maximum ratings" may cause permanent damage to the device. These are stress ratings only and functional operation of the device at these or any other conditions beyond those indicated under "recommended operating conditions" is not implied. Exposure to absolute maximum rating conditions for extended periods may affect device reliability

Recommended Operating Conditions

Symbol	Parameter	Range	Unit
V _{IN}	VIN Input Voltage	2.7 ~ 6	V
V _{LX}	LX to GND Voltage	-0.3~28	V
V _{OUT}	Converter Output Voltage	Vin~28	V
C _{IN}	Input Capacitor	2.2 ~	μF
C _{OUT}	Output Capacitor	2.2 ~	μF
T _A	Ambient Temperature	-40 ~ 85	°C
T _J	Junction Temperature	-40 ~ 125	°C

Thermal Characteristics

Symbol	Parameter	Typical Value	Unit
θ _{JA}	Junction-to-Ambient Resistance in Free Air	220	°C/W
θ _{JC}	Junction-to-Case Resistance	120	°C/W

Electrical Characteristics

Symbol	Parameter	Test Conditions	TD8210			Unit
			Min.	Typ.	Max.	
V _{IN}	Input Voltage	T _A =-40~85°C T _J =-40~120°C	2.7		6	V
IDD1	Input DC Bias Current	V _{FB} =1.3V, no switching	-	300	-	µA
IDD2		V _{FB} =1.1V, switching	-	2	5	mA
ISD		EN=GND	-	-	1	µA
	UVLO Threshold Voltage	V _{IN} Rising	2.0	2.2	2.4	V
	UVLO Hysteresis Voltage	V _{IN} Falling	50	100	150	mV
V _{REF}	Regulated Feedback Voltage	V _{IN} =2.7V~6V, T _A = 25 °C	1.212	1.23	1.248	V
		V _{IN} =2.7V~6V, T _A = -40 ~ 85 °C	1.205		1.255	
IFB	FB Input Current		-50		50	nA
FSW	Switching Frequency		1.25	1.5	1.75	MHz
RON	Power Switch On Resistance			0.2		Ω
ILIM	Power Switch Current Limit		2.2			A
	LX Leakage Current	V _{EN} = 0V, V _{LX} = 0V or 6V, V _{IN} = 6V	-1		1	µA
D _{MAX}	LX Maximum Duty Cycle		92	95	98	%
T _{SS}	Soft-Start Duration			2	3	ms
V _{TEN}	EN Voltage Threshold	V _{EN} Rising	0.4	0.7	1	V
	EN Voltage Hysteresis			0.1		V
I _{LEN}	EN Leakage Current	V _{EN} =5V, V _{IN} = 5V	-1		1	µA
T _{OTP}	Over-Temperature Protection	T _J Rising		150		°C
	Over-Temperature Protection	T _J Falling		40		°C

Typical Performance Characteristics

Output Current vs. Efficiency, $V_{OUT}=5V$

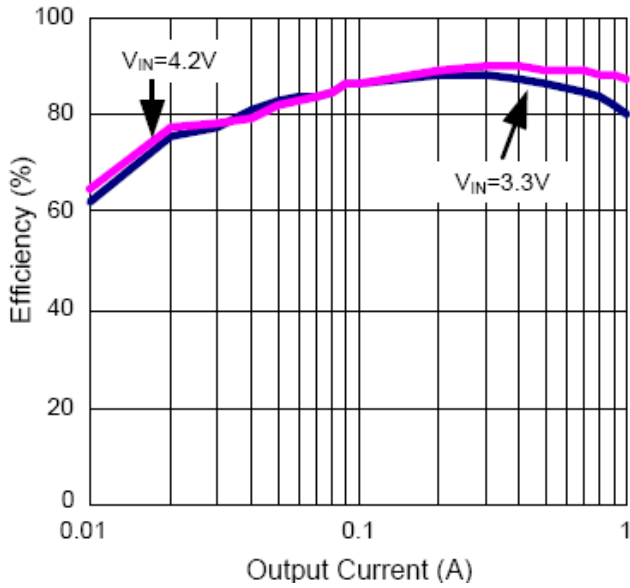

Output Current vs. Efficiency, $V_{OUT}=12V$

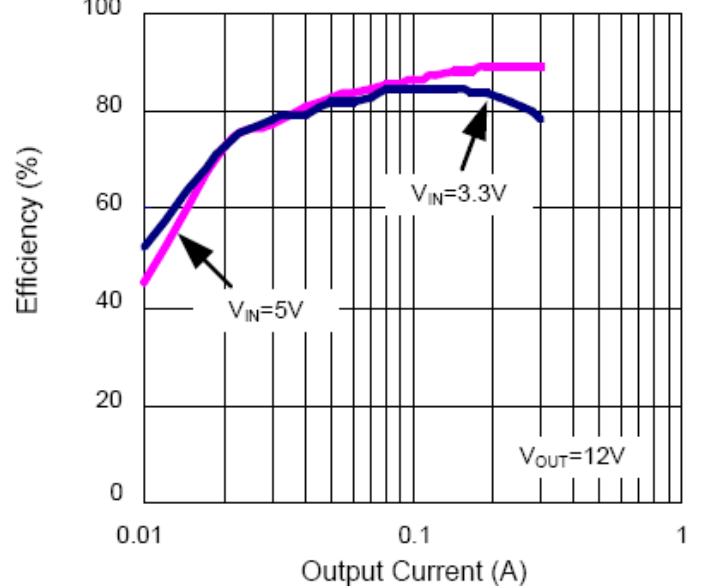

Supply Voltage vs. I_{VIN} Current

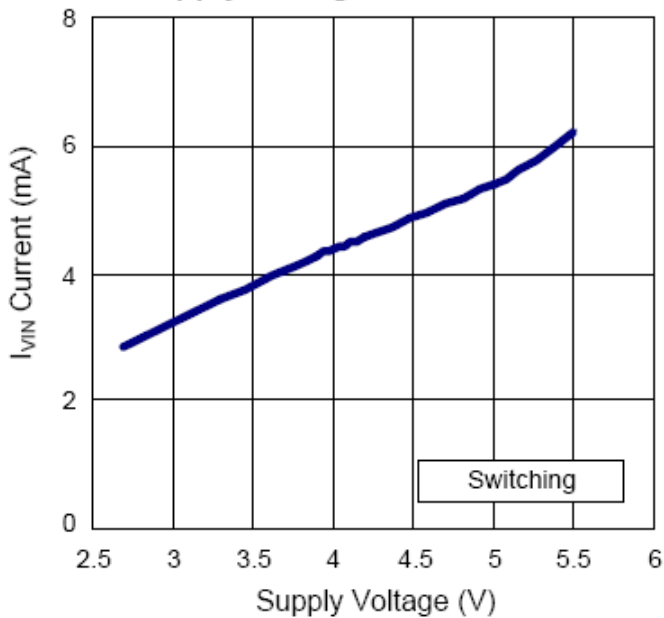

Supply Voltage vs. I_{VIN} Current

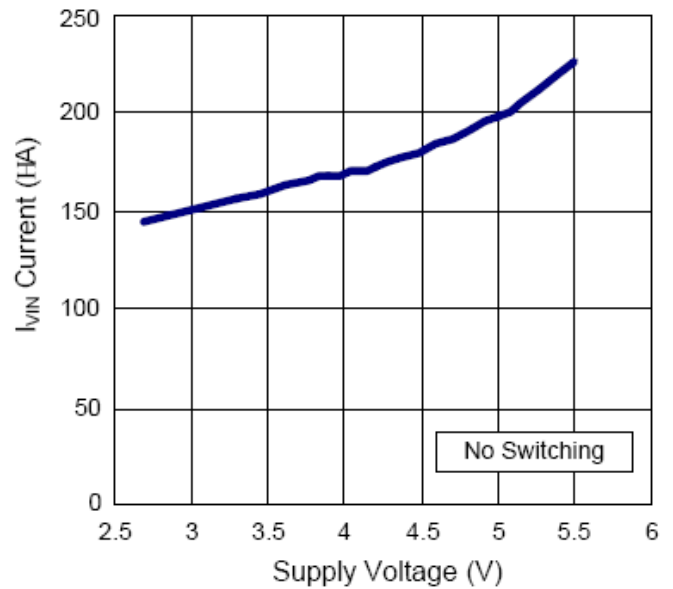

Typical Performance Characteristics(Cont.)

Supply Voltage vs. Switch ON Resistance

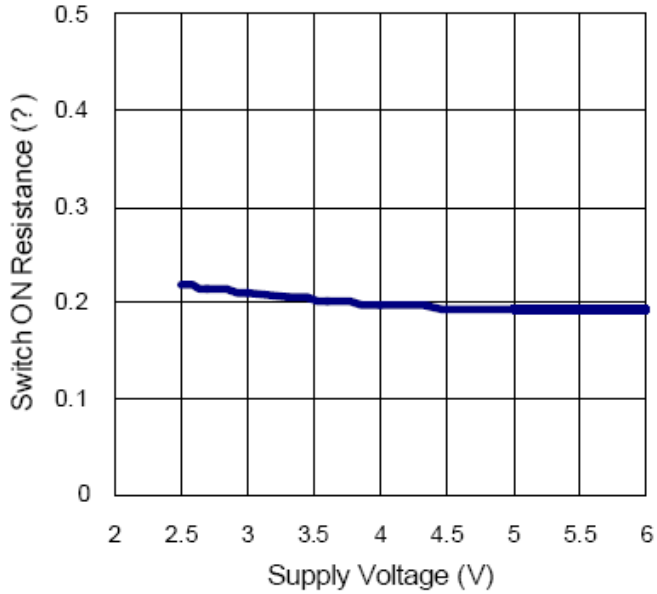

Supply Voltage vs. Maximum Duty Cycle

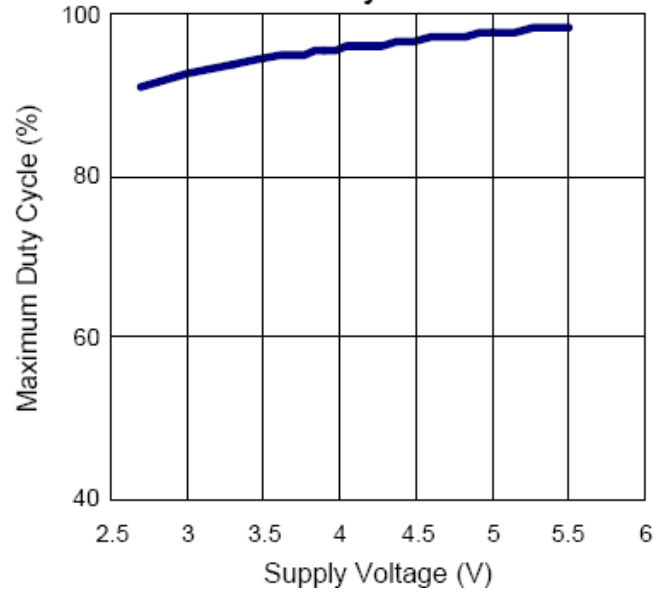

Supply Voltage vs. Reference Voltage

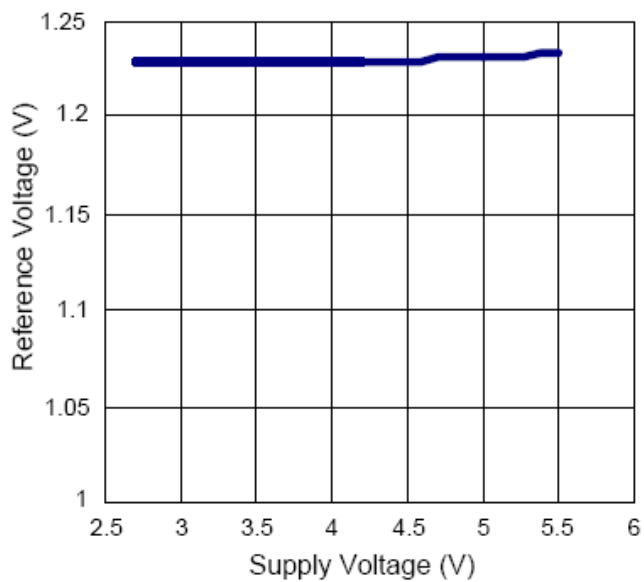

Operating Waveforms

EN Goes High - Enable, No Load

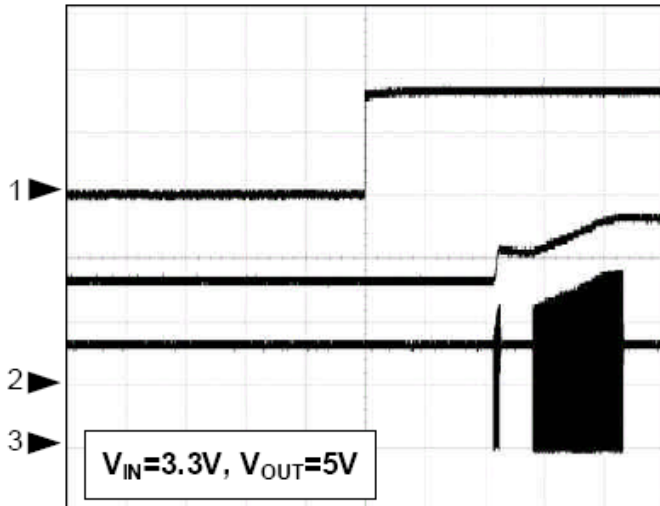

CH1: V_{EN} (2V/div)
 CH2: V_{OUT} (2V/div)
 CH3: V_{LX} (2V/div)
 Time: 200 μ s/div

EN Goes Low - Shutdown, $I_o=100mA$

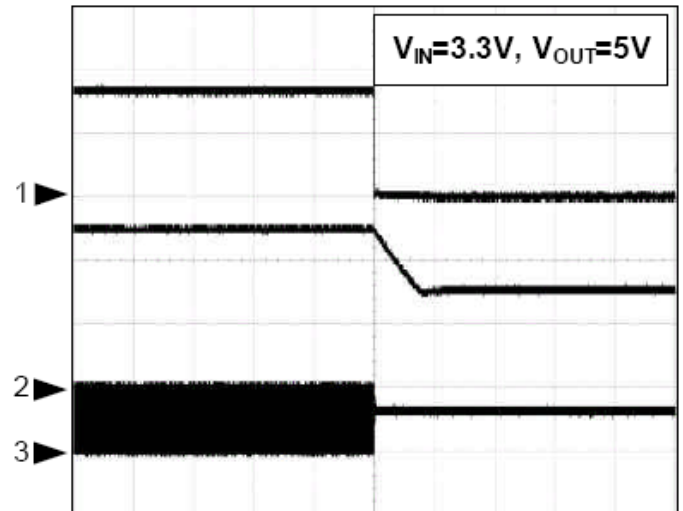

CH1: V_{EN} (2V/div)
 CH2: V_{OUT} (2V/div)
 CH3: V_{LX} (5V/div)
 Time: 200 μ s/div

Load Transient, $I_o=500mA \rightarrow 1A \rightarrow 500mA$

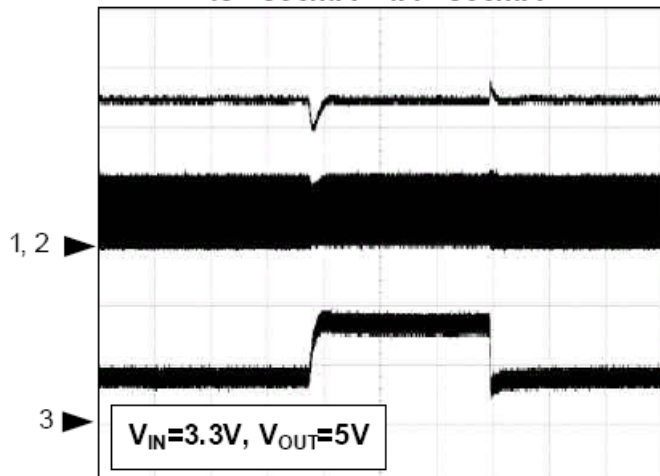

CH1: V_{OUT} (2V/div)
 CH2: V_{LX} (5V/div)
 CH3: I_L (1A/div)
 Time: 500 μ s/div

Normal Operation

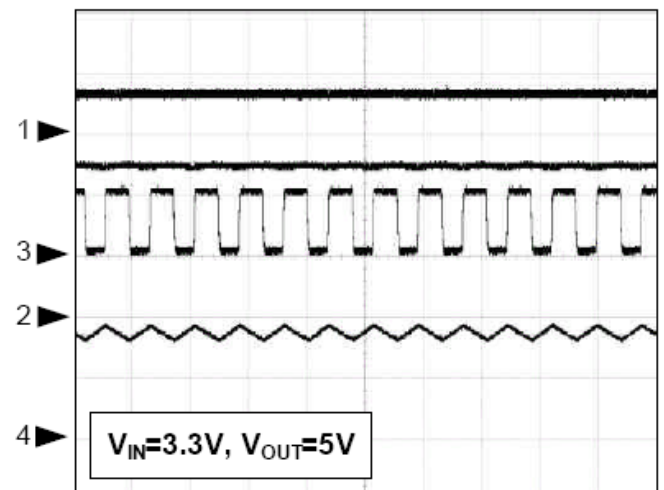

CH1: V_{EN} (5V/div)
 CH2: V_{OUT} (2V/div)
 CH3: V_{LX} (5V/div)
 CH4: I_L (1A/div)
 Time: 1 μ s/div

Operating Waveforms(Cont.)

EN Goes High - Enable, No Load

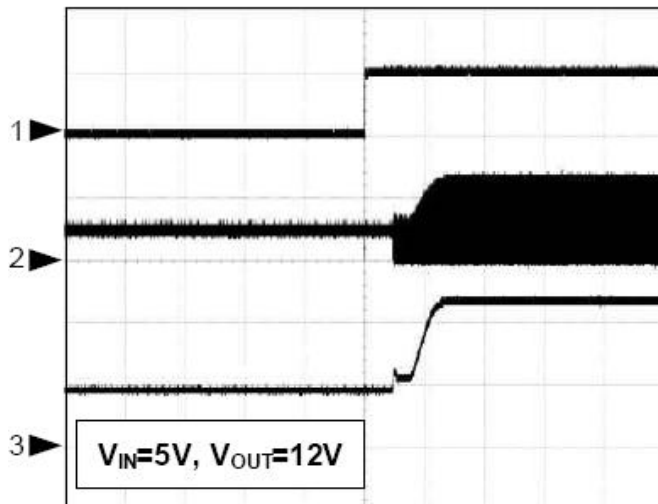

CH1: V_{EN} (5V/div)
 CH2: V_{LX} (10V/div)
 CH3: V_{OUT} (5V/div)
 Time: 500 μ s/div

EN Goes Low - Shutdown, $I_o=500mA$

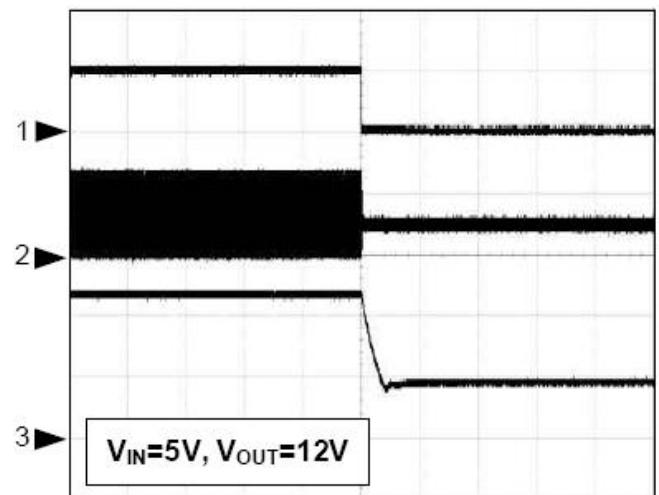

CH1: V_{EN} (5V/div)
 CH2: V_{LX} (10V/div)
 CH3: V_{OUT} (5V/div)
 Time: 200 μ s/div

Load Transient, $I_o = 100mA \rightarrow 500mA \rightarrow 100mA$

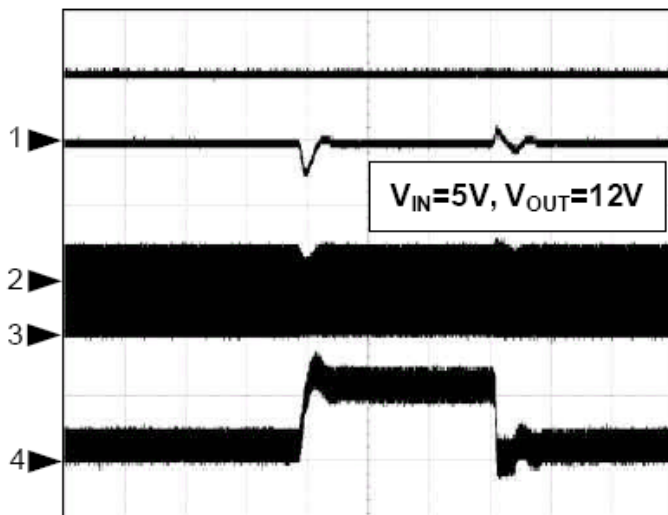

CH1: V_{EN} (5V/div)
 CH2: V_{OUT} (5V/div)
 CH3: V_{LX} (10V/div)
 CH4: I_L (1A/div)
 Time: 500 μ s/div

Normal Operation

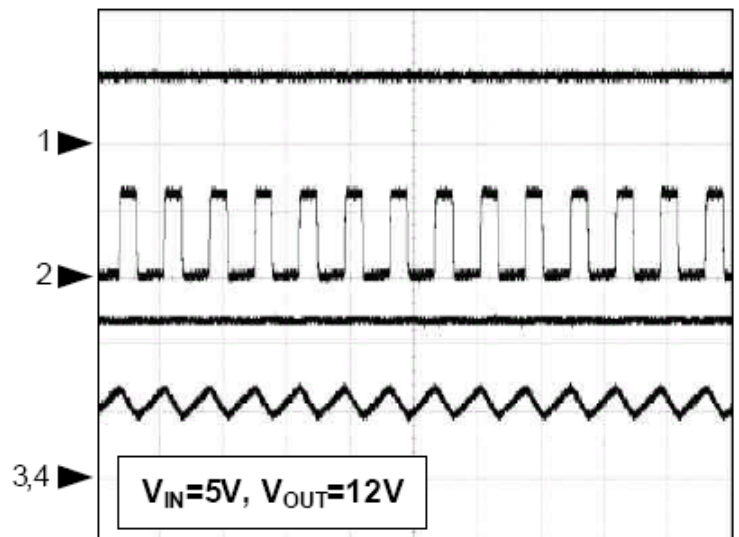

CH1: V_{EN} (5V/div)
 CH2: V_{OUT} (2V/div)
 CH3: V_{LX} (5V/div)
 CH4: I_L (1A/div)
 Time: 1 μ s/div

Typical Application Circuit

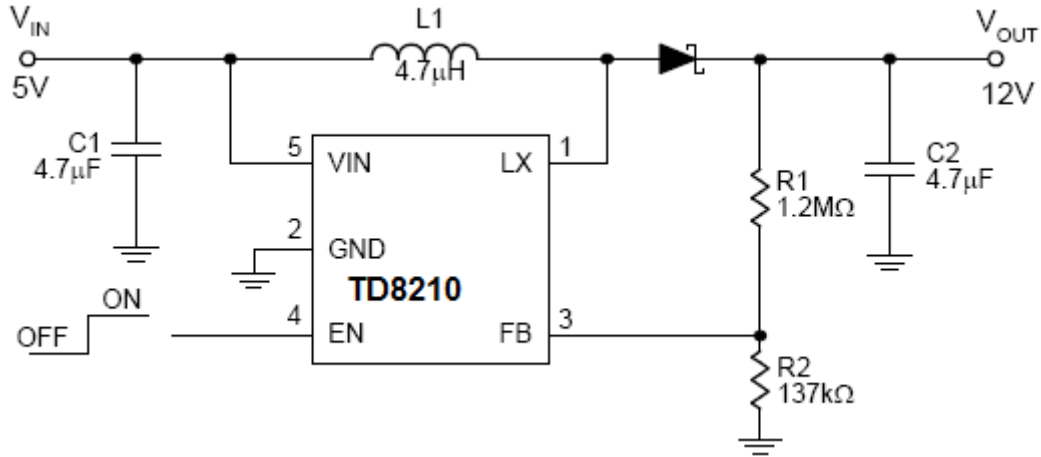

Figure 1. Typical 5V to 12V Supply

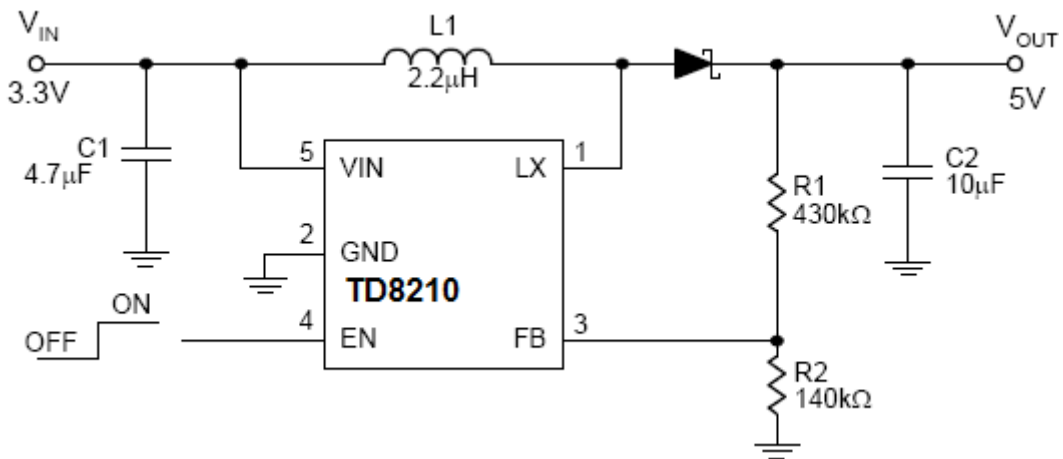

Figure 2. Standard 3.3V to 5V Supply

Typical Application Circuit(Cont.)

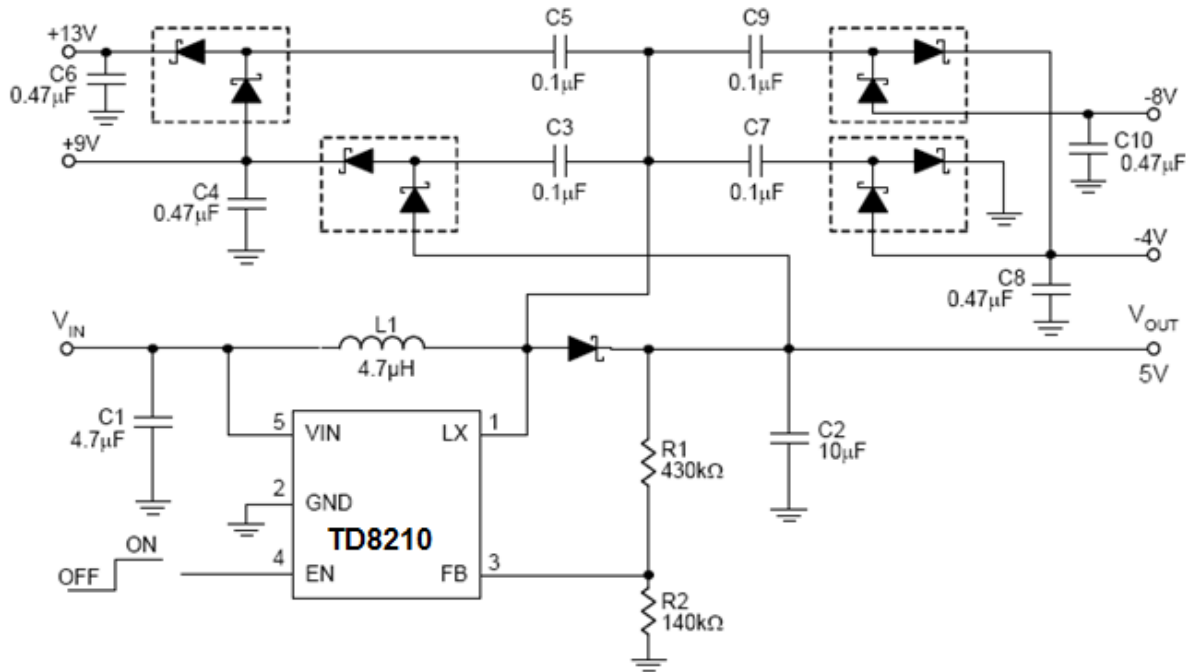

Figure 3. Multiple Output for TFT-LCD Power Supply

Function Description

Main Control Loop

The TD8210 is a constant frequency and current-mode switching regulator. In normal operation, the internal Nchannel power MOSFET is turned on each cycle when the oscillator sets an internal RS latch, and then turned off when an internal comparator (ICMP) resets the latch. The peak inductor current at which ICMP resets the RS latch is controlled by the voltage on the COMP node which is the output of the error amplifier (EAMP). An external resistive divider connected between V_{OUT} and ground allows the EAMP to receive an output feedback voltage V_{FB} at FB pin. When the load current increases, it causes a slightly to decrease in V_{FB} associated with the 1.23V reference, which in turn, it causes the COMP voltage to increase until the average inductor current matches the new load current.

VIN Under-Voltage Lockout (UVLO)

The Under-Voltage Lockout (UVLO) circuit compares the input voltage at VIN with the UVLO threshold to ensure the input voltage is high enough for reliable operation. The 100mV (typ) hysteresis prevents supply transients from causing a restart. Once the input voltage exceeds the UVLO rising threshold, startup begins. When the input voltage falls below the UVLO falling threshold, the controller turns off the converter.

Soft-Start

The TD8210 has a built-in soft-start to control the output voltage rise during start-up. During soft-start, an internal ramp voltage, connected to the one of the positive inputs of the error amplifier, raises up to replace the reference voltage (1.23V typical) until the ramp voltage reaches the reference voltage.

Current-Limit Protection

The TD8210 monitors the inductor current, flows through the N-channel MOSFET, and limits the current peak at current-limit level to prevent loads and the TD8210 from damaging during overload or short-circuit conditions.

Over-Temperature Protection (OTP)

The over-temperature circuit limits the junction temperature of the TD8210. When the junction temperature exceeds 150°C, a thermal sensor turns off the power MOSFET allowing the devices to cool. The thermal sensor allows the converters to start a soft-start process and regulates the output voltage again after the junction temperature cools by 40°C. The OTP is designed with a 40°C hysteresis to lower the average Junction Temperature (T_J) during continuous thermal overload conditions increasing the lifetime of the device.

Enable/Shutdown

Driving EN to the ground places the TD8210 in shutdown mode. When in shutdown, the internal power MOSFET turns off, all internal circuitry shuts down, and the quiescent supply current reduces to 1µA maximum.

Application Information

Input Capacitor Selection

The input capacitor (C_{IN}) reduces the ripple of the input current drawn from the input supply and reduces noise injection into the IC. The reflected ripple voltage will be smaller when an input capacitor with larger capacitance is used. For reliable operation, it is recommended to select the capacitor with maximum voltage rating at least 1.2 times of the maximum input voltage. The capacitors should be placed close to the VIN and the GND.

Inductor Selection

Selecting an inductor with low dc resistance reduces conduction losses and achieves high efficiency. The efficiency is moderated whilst using small chip inductor which operates with higher inductor core losses. Therefore, it is necessary to take further consideration while choosing an adequate inductor. Mainly, the inductor value determines the inductor ripple current: larger inductor value results in smaller inductor ripple current and lower conduction losses of the converter. However, larger inductor value generates slower load transient response. A reasonable design rule is to set the ripple current, ΔI_L , to be 30% to 50% of the maximum average inductor current, $I_{L(AVG)}$. The inductor value can be obtained as below,

$$L \geq \left(\frac{V_{IN}}{V_{OUT}} \right)^2 \times \frac{V_{OUT} - V_{IN}}{F_{SW} \cdot I_{OUT(MAX)}} \times \frac{\eta}{\left(\frac{\Delta I_L}{I_{L(AVG)}} \right)}$$

where

V_{IN} = input voltage

V_{OUT} = output voltage

F_{SW} = switching frequency in MHz

I_{OUT} = maximum output current in amp.

η = Efficiency

$\Delta I_L / I_{L(AVG)}$ = inductor ripple current/average current

(0.3 to 0.5 typical)

To avoid the saturation of the inductor, the inductor should be rated at least for the maximum input current of the converter plus the inductor ripple current. The maximum input current is calculated as below:

$$I_{IN(MAX)} = \frac{I_{OUT(MAX)} \cdot V_{OUT}}{V_{IN} \cdot \eta}$$

The peak inductor current is calculated as the following equation:

$$I_{PEAK} = I_{IN(MAX)} + \frac{1}{2} \cdot \frac{V_{IN} \cdot (V_{OUT} - V_{IN})}{V_{OUT} \cdot L \cdot F_{SW}}$$

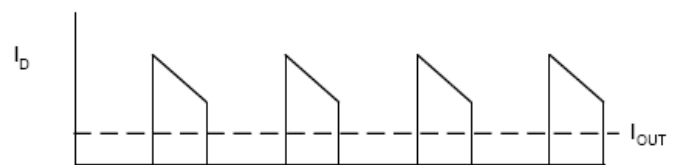
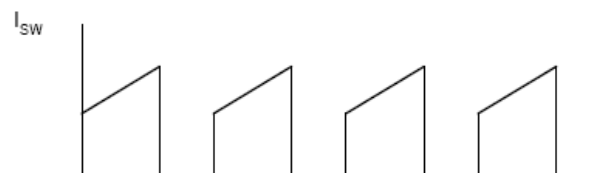
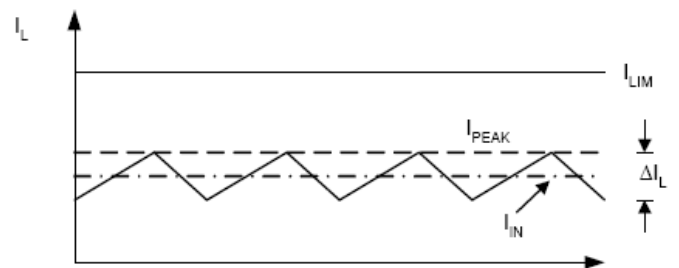
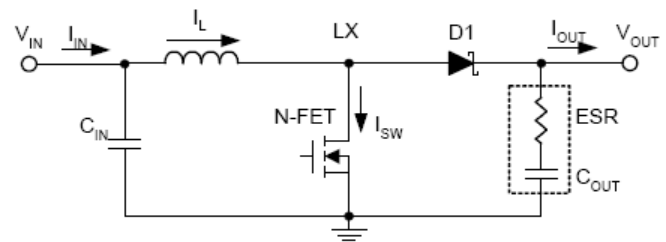

Output Capacitor Selection

The current-mode control scheme of the TD8210 allows the usage of tiny ceramic capacitors. The higher capacitor value provides good load transients response. Ceramic capacitors with low ESR values have the lowest output voltage ripple and are recommended. If required, tantalum capacitors may be used as well. The output ripple is the sum of the voltages across the ESR and the ideal output capacitor.

$$\Delta V_{OUT} = \Delta V_{ESR} + \Delta V_{C_{OUT}}$$

Application Information(Cont.)

I Output Capacitor Selection (Cont.)

$$\Delta V_{COUT} \approx \frac{I_{OUT}}{C_{OUT}} \cdot \left(\frac{V_{OUT} - V_{IN}}{V_{OUT} \cdot F_{SW}} \right)$$

$$\Delta V_{ESR} \approx I_{PEAK} \cdot R_{ESR}$$

where I_{PEAK} is the peak inductor current.

For ceramic capacitor application, the output voltage ripple is dominated by the ΔV_{COUT}. When choosing the input and output ceramic capacitors, the X5R or X7R with their good temperature and voltage characteristics are recommended.

Output Voltage Setting

The output voltage is set by a resistive divider. The external resistive divider is connected to the output which allows remote voltage sensing as shown in “Typical Application Circuits”. A suggestion of the maximum value of R1 is 2MΩ and R2 is 200kΩ for keeping the minimum current that provides enough noise rejection ability through the resistor divider. The output voltage can be calculated as below:

$$V_{OUT} = V_{REF} \cdot \left(1 + \frac{R1}{R2} \right) = 1.23 \cdot \left(1 + \frac{R1}{R2} \right)$$

Diode Selection

To achieve the high efficiency, a Schottky diode must be used. The current rating of the diode must meet the peak current rating of the converter.

Layout Consideration

For all switching power supplies, the layout is an important step in the design especially at high peak currents and switching frequencies. If the layout is not carefully done, the regulator might show noise problems and duty cycle jitter.

1. The input capacitor should be placed close to the VIN and the GND without any via holes for good input voltage filtering.
2. To minimize copper trace connections that can inject noise into the system, the inductor should be placed as close as possible to the LX pin to minimize the noise coupling into other circuits.

3. Since the feedback pin and network is a high impedance circuit the feedback network should be routed away from the inductor. The feedback pin and feedback network should be shielded with a ground plane or trace to minimize noise coupling into this circuit.
4. A star ground connection or ground plane minimizes ground shifts and noise is recommended.

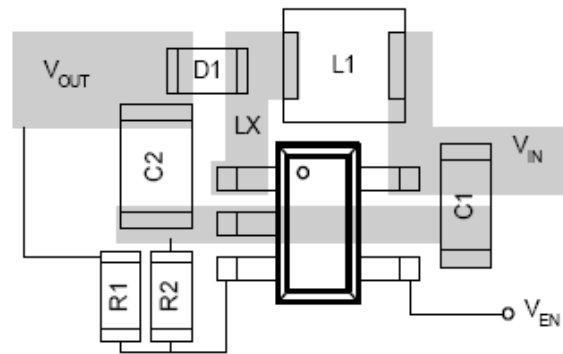

Optimized TD8210 Layout

Package Information

SOT23-5 Package Outline Dimensions

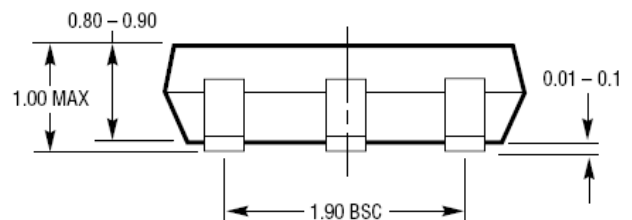
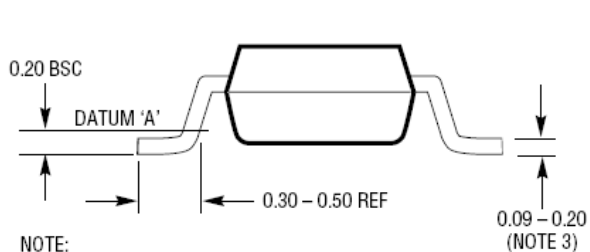
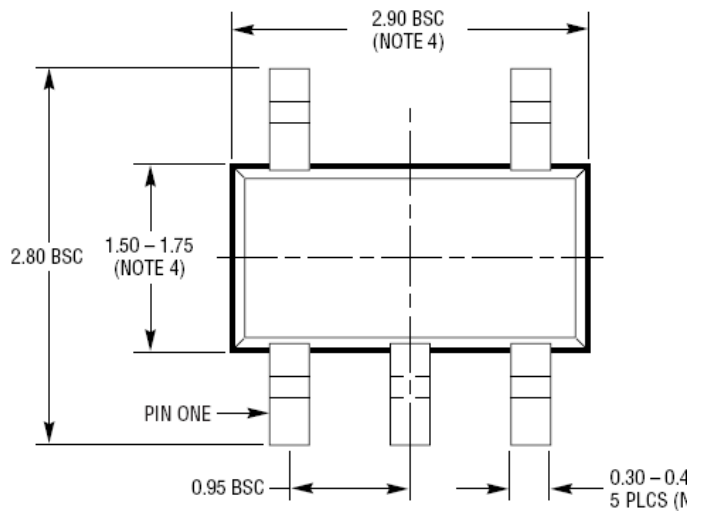
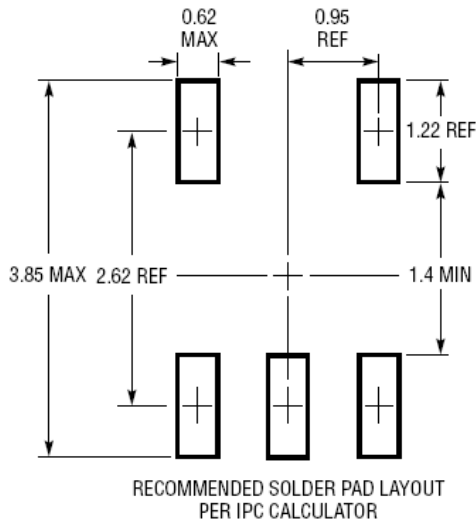

- NOTE:
1. DIMENSIONS ARE IN MILLIMETERS
 2. DRAWING NOT TO SCALE
 3. DIMENSIONS ARE INCLUSIVE OF PLATING
 4. DIMENSIONS ARE EXCLUSIVE OF MOLD FLASH AND METAL BURR
 5. MOLD FLASH SHALL NOT EXCEED 0.254mm
 6. JEDEC PACKAGE REFERENCE IS MO-193

SS T50T-23 0002

Design Notes