

Notice for TAIYO YUDEN products

Please read this notice before using the TAIYO YUDEN products.

⚠️ REMINDERS

■ Product Information in this Catalog

Product information in this catalog is as of October 2019. All of the contents specified herein and production status of the products listed in this catalog are subject to change without notice due to technical improvement of our products, etc. Therefore, please check for the latest information carefully before practical application or use of our products.

Please note that TAIYO YUDEN shall not be in any way responsible for any damages and defects in products or equipment incorporating our products, which are caused under the conditions other than those specified in this catalog or individual product specification sheets.

■ Approval of Product Specifications

Please contact TAIYO YUDEN for further details of product specifications as the individual product specification sheets are available. When using our products, please be sure to approve our product specifications or make a written agreement on the product specification with TAIYO YUDEN in advance.

■ Pre-Evaluation in the Actual Equipment and Conditions

Please conduct validation and verification of our products in actual conditions of mounting and operating environment before using our products.

■ Limited Application

1. Equipment Intended for Use

The products listed in this catalog are intended for general-purpose and standard use in general electronic equipment (e.g., AV equipment, OA equipment, home electric appliances, office equipment, information and communication equipment including, without limitation, mobile phone, and PC) and other equipment specified in this catalog or the individual product specification sheets.

TAIYO YUDEN has the line-up of the products intended for use in automotive electronic equipment, telecommunications infrastructure and industrial equipment, or medical devices classified as GHTF Classes A to C (Japan Classes I to III). Therefore, when using our products for these equipment, please check available applications specified in this catalog or the individual product specification sheets and use the corresponding products.

2. Equipment Requiring Inquiry

Please be sure to contact TAIYO YUDEN for further information before using the products listed in this catalog for the following equipment (excluding intended equipment as specified in this catalog or the individual product specification sheets) which may cause loss of human life, bodily injury, serious property damage and/or serious public impact due to a failure or defect of the products and/or malfunction attributed thereto.

- (1) Transportation equipment (automotive powertrain control system, train control system, and ship control system, etc.)
- (2) Traffic signal equipment
- (3) Disaster prevention equipment, crime prevention equipment
- (4) Medical devices classified as GHTF Class C (Japan Class III)
- (5) Highly public information network equipment, data-processing equipment (telephone exchange, and base station, etc.)
- (6) Any other equipment requiring high levels of quality and/or reliability equal to the equipment listed above

3. Equipment Prohibited for Use

Please do not incorporate our products into the following equipment requiring extremely high levels of safety and/or reliability.

- (1) Aerospace equipment (artificial satellite, rocket, etc.)
- (2) Aviation equipment *¹
- (3) Medical devices classified as GHTF Class D (Japan Class IV), implantable medical devices *²

- (4) Power generation control equipment (nuclear power, hydroelectric power, thermal power plant control system, etc.)
- (5) Undersea equipment (submarine repeating equipment, underwater work equipment, etc.)
- (6) Military equipment
- (7) Any other equipment requiring extremely high levels of safety and/or reliability equal to the equipment listed above

*Notes:

1. There is a possibility that our products can be used only for aviation equipment that does not directly affect the safe operation of aircraft (e.g., in-flight entertainment, cabin light, electric seat, cooking equipment) if such use meets requirements specified separately by TAIYO YUDEN. Please be sure to contact TAIYO YUDEN for further information before using our products for such aviation equipment.
2. Implantable medical devices contain not only internal unit which is implanted in a body, but also external unit which is connected to the internal unit.

4. Limitation of Liability

Please note that unless you obtain prior written consent of TAIYO YUDEN, TAIYO YUDEN shall not be in any way responsible for any damages incurred by you or third parties arising from use of the products listed in this catalog for any equipment that is not intended for use by TAIYO YUDEN, or any equipment requiring inquiry to TAIYO YUDEN or prohibited for use by TAIYO YUDEN as described above.

■ Safety Design

When using our products for high safety and/or reliability-required equipment or circuits, please fully perform safety and/or reliability evaluation. In addition, please install (i) systems equipped with a protection circuit and a protection device and/or (ii) systems equipped with a redundant circuit or other system to prevent an unsafe status in the event of a single fault for a failsafe design to ensure safety.

■ Intellectual Property Rights

Information contained in this catalog is intended to convey examples of typical performances and/or applications of our products and is not intended to make any warranty with respect to the intellectual property rights or any other related rights of TAIYO YUDEN or any third parties nor grant any license under such rights.

■ Limited Warranty

Please note that the scope of warranty for our products is limited to the delivered our products themselves and TAIYO YUDEN shall not be in any way responsible for any damages resulting from a failure or defect in our products. Notwithstanding the foregoing, if there is a written agreement (e.g., supply and purchase agreement, quality assurance agreement) signed by TAIYO YUDEN and your company, TAIYO YUDEN will warrant our products in accordance with such agreement.

■ TAIYO YUDEN's Official Sales Channel

The contents of this catalog are applicable to our products which are purchased from our sales offices or authorized distributors (hereinafter "TAIYO YUDEN's official sales channel"). Please note that the contents of this catalog are not applicable to our products purchased from any seller other than TAIYO YUDEN's official sales channel.

■ Caution for Export

Some of our products listed in this catalog may require specific procedures for export according to "U.S. Export Administration Regulations", "Foreign Exchange and Foreign Trade Control Law" of Japan, and other applicable regulations. Should you have any questions on this matter, please contact our sales staff.

SMD POWER INDUCTORS (NR SERIES/NR SERIES H TYPE/S TYPE/V TYPE)



REFLOW

■ PARTS NUMBER

* Operating Temp.: -25~+120°C (NRS40/50/60/80: -25~+125°C) (Including self-generated heat)

N	R	△	4	0	1	8	T	△	1	0	0	M	△
①			②				③		④			⑤	⑥

△=Blank space

① Series name

Code	Series name
NR△	Coating resin specification
NRH	
NRS	
NRV	

② Dimensions (L×W×H)

Code	Dimensions (L×W×H) [mm]
2010	2.0×2.0×1.0
2012	2.0×2.0×1.2
2410	2.4×2.4×1.0
2412	2.4×2.4×1.2
3010	3.0×3.0×1.0
3012	3.0×3.0×1.2
3015	3.0×3.0×1.5
4010	4.0×4.0×1.0
4012	4.0×4.0×1.2
4018	4.0×4.0×1.8
5010	4.9×4.9×1.0
5012	4.9×4.9×1.2
5014	4.9×4.9×1.4
5020	4.9×4.9×2.0
5024	4.9×4.9×2.4
5030	4.9×4.9×3.0
5040	4.9×4.9×4.0
6010	6.0×6.0×1.0
6012	6.0×6.0×1.2
6014	6.0×6.0×1.4
6020	6.0×6.0×2.0
6028	6.0×6.0×2.8
6045	6.0×6.0×4.5
8030	8.0×8.0×3.0
8040	8.0×8.0×4.0

③ Packaging

Code	Packaging
T△	Taping

④ Nominal inductance

Code (example)	Nominal inductance [μH]
2R2	2.2
100	10
101	100

※R=Decimal point

⑤ Inductance tolerance

Code	Inductance tolerance
M	±20%
N	±30%

⑥ Internal code

► This catalog contains the typical specification only due to the limitation of space. When you consider the purchase of our products, please check our product specification sheets. For details of each product (characteristics graph, reliability information, precautions for use, and so on), see our website (<http://www.ty-top.com/>).

STANDARD EXTERNAL DIMENSIONS / STANDARD QUANTITY



Type	A	B	C
NRV2010	0.65	1.35	2.0
NRS2012, NRV2012			
NRH2410	0.7	1.45	2.0
NRH2412			
NR 3010, NRH3010	0.8	2.2	2.7
NR 3012, NRH3012, NRV3012			
NR 3015, NRS3015			
NR 4010, NRS4010	1.2	2.8	3.7
NR 4012, NRS4012			
NR 4018, NRS4018			
NRS8030	1.8	5.6	7.5
NR 8040, NRS8040			

Unit: mm

Type	L	W	H	e	f	Standard quantity [pcs] Taping
NRV2010	2.0±0.1 (0.079±0.004)	2.0±0.1 (0.079±0.004)	1.0 max (0.039 max)	0.5±0.2 (0.020±0.008)	1.25±0.2 (0.050±0.008)	2500
NRS2012 NRV2012	2.0±0.1 (0.079±0.004)	2.0±0.1 (0.079±0.004)	1.2 max (0.047 max)	0.5±0.2 (0.020±0.008)	1.25±0.2 (0.050±0.008)	2500
NRH2410	2.4±0.1 (0.095±0.004)	2.4±0.1 (0.095±0.004)	1.0 max (0.039 max)	0.6±0.2 (0.024±0.008)	1.45±0.2 (0.057±0.008)	2500
NRH2412	2.4±0.1 (0.095±0.004)	2.4±0.1 (0.095±0.004)	1.2 max (0.047 max)	0.6±0.2 (0.024±0.008)	1.45±0.2 (0.057±0.008)	2500
NR 3010 NRH3010	3.0±0.1 (0.118±0.004)	3.0±0.1 (0.118±0.004)	1.0 max (0.039 max)	0.9±0.2 (0.035±0.008)	1.9±0.2 (0.075±0.008)	2000
NR 3012 NRH3012 NRV3012	3.0±0.1 (0.118±0.004)	3.0±0.1 (0.118±0.004)	1.2 max (0.047 max)	0.9±0.2 (0.035±0.008)	1.9±0.2 (0.075±0.008)	2000
NR 3015 NRS3015	3.0±0.1 (0.118±0.004)	3.0±0.1 (0.118±0.004)	1.5 max (0.059 max)	0.9±0.2 (0.035±0.008)	1.9±0.2 (0.075±0.008)	2000
NR 4010 NRS4010	4.0±0.2 (0.158±0.008)	4.0±0.2 (0.158±0.008)	1.0 max (0.039 max)	1.1±0.2 (0.043±0.008)	2.5±0.2 (0.098±0.008)	5000
NR 4012 NRS4012	4.0±0.2 (0.158±0.008)	4.0±0.2 (0.158±0.008)	1.2 max (0.047 max)	1.1±0.2 (0.043±0.008)	2.5±0.2 (0.098±0.008)	4500
NR 4018 NRS4018	4.0±0.2 (0.158±0.008)	4.0±0.2 (0.158±0.008)	1.8 max (0.071 max)	1.1±0.2 (0.043±0.008)	2.5±0.2 (0.098±0.008)	3500
NRS8030	8.0±0.2 (0.315±0.008)	8.0±0.2 (0.315±0.008)	3.0 max (0.118 max)	1.60±0.3 (0.063±0.012)	5.6±0.3 (0.22±0.012)	1000
NR 8040 NRS8040	8.0±0.2 (0.315±0.008)	8.0±0.2 (0.315±0.008)	*1) 4.2 max (0.165 max) *2) 4.0 max (0.158 max)	1.60±0.3 (0.063±0.012)	5.6±0.3 (0.22±0.012)	1000

*1) 0R9~6R8 type, *2) 100~221 type

Unit: mm (inch)

► This catalog contains the typical specification only due to the limitation of space. When you consider the purchase of our products, please check our product specification sheets. For details of each product (characteristics graph, reliability information, precautions for use, and so on), see our website (<http://www.ty-top.com/>).



Recommended Land Patterns



Type	A	B	C
NRS5010	1.5	3.6	4.0
NRS5012			
NRS5014			
NRS5020			
NRS5024			
NRS5030			
NR 5040, NRS5040	1.6	4.7	5.7
NRS6010			
NR 6012, NRS6012			
NRS6014			
NR 6020, NRS6020			
NR 6028, NRS6028			
NR 6045, NRS6045			

Unit: mm

Type	L	W	H	e	f	ΔI	Standard quantity [pcs] Taping
NRS5010	4.9±0.2 (0.193±0.008)	4.9±0.2 (0.193±0.008)	1.0 max (0.039 max)	1.2±0.2 (0.047±0.008)	3.3±0.2 (0.130±0.008)	1.3typ (0.051typ)	1000
NRS5012	4.9±0.2 (0.193±0.008)	4.9±0.2 (0.193±0.008)	1.2 max (0.047 max)	1.2±0.2 (0.047±0.008)	3.3±0.2 (0.130±0.008)	1.3typ (0.051typ)	1000
NRS5014	4.9±0.2 (0.193±0.008)	4.9±0.2 (0.193±0.008)	1.4 max (0.055 max)	1.2±0.2 (0.047±0.008)	3.3±0.2 (0.130±0.008)	1.3typ (0.051typ)	1000
NRS5020	4.9±0.2 (0.193±0.008)	4.9±0.2 (0.193±0.008)	2.0 max (0.079 max)	1.2±0.2 (0.047±0.008)	3.3±0.2 (0.130±0.008)	1.3typ (0.051typ)	800
NRS5024	4.9±0.2 (0.193±0.008)	4.9±0.2 (0.193±0.008)	*3) 2.5 max (0.098 max) *4) 2.4 max (0.095 max)	1.2±0.2 (0.047±0.008)	3.3±0.2 (0.130±0.008)	1.3typ (0.051typ)	2500
NRS5030	4.9±0.2 (0.193±0.008)	4.9±0.2 (0.193±0.008)	*5) 3.1 max (0.122 max) *6) 3.0 max (0.118 max)	1.2±0.2 (0.047±0.008)	3.3±0.2 (0.130±0.008)	1.3typ (0.051typ)	500
NR 5040 NRS5040	4.9±0.2 (0.193±0.008)	4.9±0.2 (0.193±0.008)	*7) 4.1 max (0.161 max) *8) 4.0 max (0.158 max)	1.2±0.2 (0.047±0.008)	3.3±0.2 (0.130±0.008)	1.3typ (0.051typ)	1500
NRS6010	6.0±0.2 (0.236±0.008)	6.0±0.2 (0.236±0.008)	1.0 max (0.039 max)	1.35±0.2 (0.053±0.008)	4.0±0.2 (0.158±0.008)	2.3typ (0.091typ)	1000
NR 6012 NRS6012	6.0±0.2 (0.236±0.008)	6.0±0.2 (0.236±0.008)	1.2 max (0.047 max)	1.35±0.2 (0.053±0.008)	4.0±0.2 (0.158±0.008)	2.3typ (0.091typ)	1000
NRS6014	6.0±0.2 (0.236±0.008)	6.0±0.2 (0.236±0.008)	1.4 max (0.055 max)	1.35±0.2 (0.053±0.008)	4.0±0.2 (0.158±0.008)	2.3typ (0.091typ)	1000
NR 6020 NRS6020	6.0±0.2 (0.236±0.008)	6.0±0.2 (0.236±0.008)	2.0 max (0.079 max)	1.35±0.2 (0.053±0.008)	4.0±0.2 (0.158±0.008)	2.3typ (0.091typ)	2500
NR 6028 NRS6028	6.0±0.2 (0.236±0.008)	6.0±0.2 (0.236±0.008)	2.8 max (0.110 max)	1.35±0.2 (0.053±0.008)	4.0±0.2 (0.158±0.008)	2.3typ (0.091typ)	2000
NR 6045 NRS6045	6.0±0.2 (0.236±0.008)	6.0±0.2 (0.236±0.008)	4.5 max (0.177 max)	1.35±0.2 (0.053±0.008)	4.0±0.2 (0.158±0.008)	2.3typ (0.091typ)	1500

*3) 1R0~1R5 type, *4) 2R2~330 type
 *5) R47~100 type, *6) 150~470 type
 *7) 1R5~100 type, *8) 150~470 type

Unit: mm (inch)

► This catalog contains the typical specification only due to the limitation of space. When you consider the purchase of our products, please check our product specification sheets. For details of each product (characteristics graph, reliability information, precautions for use, and so on), see our website (<http://www.ty-top.com/>).

■ PARTS NUMBER

● NRS2012 Shielded type

Parts number	EHS	Nominal inductance [μH]	Inductance tolerance	Self-resonant frequency [MHz] (min.)	DC Resistance [Ω] (±20%)	Rated current ※) [mA]				Measuring frequency [kHz]
						Saturation current: Idc1		Temperature rise current: Idc2		
						Max.	Typ.	Max.	Typ.	
NRS2012T 1R0N GJ	RoHS	1.0	±30%	—	0.070	1,900	2,050	1,700	1,850	100
NRS2012T 1R5N GJ	RoHS	1.5	±30%	—	0.090	1,650	1,800	1,500	1,650	100
NRS2012T 2R2M GJ	RoHS	2.2	±20%	—	0.107	1,350	1,500	1,370	1,500	100
NRS2012T 3R3M GJ	RoHS	3.3	±20%	—	0.190	1,000	1,150	1,020	1,100	100
NRS2012T 4R7M GJ	RoHS	4.7	±20%	—	0.241	900	1,050	910	1,000	100

● NRV2010 type

Parts number	EHS	Nominal inductance [μH]	Inductance tolerance	Self-resonant frequency [MHz] (min.)	DC Resistance [Ω] (±20%)	Rated current ※) [mA]				Measuring frequency [kHz]
						Saturation current: Idc1		Temperature rise current: Idc2		
						Max.	Typ.	Max.	Typ.	
NRV2010T R47N GF	RoHS	0.47	±30%	—	0.052	2,100	2,250	2,000	2,300	100
NRV2010T R68N GF	RoHS	0.68	±30%	—	0.060	1,850	2,000	1,850	2,100	100
NRV2010T 1R0N GF	RoHS	1.0	±30%	—	0.080	1,550	1,700	1,600	1,850	100
NRV2010T 1R5M GF	RoHS	1.5	±20%	—	0.100	1,350	1,450	1,450	1,650	100
NRV2010T 2R2M GF	RoHS	2.2	±20%	—	0.175	1,100	1,200	1,100	1,200	100
NRV2010T 3R3M GF	RoHS	3.3	±20%	—	0.250	890	950	1,000	1,100	100
NRV2010T 4R7M GF	RoHS	4.7	±20%	—	0.320	760	810	820	930	100

● NRV2012 type

Parts number	EHS	Nominal inductance [μH]	Inductance tolerance	Self-resonant frequency [MHz] (min.)	DC Resistance [Ω] (±20%)	Rated current ※) [mA]				Measuring frequency [kHz]
						Saturation current: Idc1		Temperature rise current: Idc2		
						Max.	Typ.	Max.	Typ.	
NRV2012T 1R0N GF	RoHS	1.0	±30%	—	0.073	2,200	2,350	1,650	1,830	100
NRV2012T 1R5N GF	RoHS	1.5	±30%	—	0.100	1,800	1,950	1,400	1,550	100
NRV2012T 2R2M GF	RoHS	2.2	±20%	—	0.129	1,600	1,700	1,200	1,350	100
NRV2012T 3R3M GF	RoHS	3.3	±20%	—	0.227	1,250	1,350	900	1,040	100
NRV2012T 4R7M GF	RoHS	4.7	±20%	—	0.325	1,100	1,150	750	850	100

● NRH2410 Shielded type

Parts number	EHS	Nominal inductance [μH]	Inductance tolerance	Self-resonant frequency [MHz] (min.)	DC Resistance [Ω] (±20%)	Rated current ※) [mA]				Measuring frequency [kHz]
						Saturation current: Idc1		Temperature rise current: Idc2		
						Max.	Typ.	Max.	Typ.	
NRH2410T R68NN 4	RoHS	0.68	±30%	120	0.060	2,200	2,300	1,570	1,810	100
NRH2410T 1R0NN 4	RoHS	1.0	±30%	106	0.070	1,800	1,950	1,410	1,640	100
NRH2410T 1R5MN	RoHS	1.5	±20%	94	0.110	1,550	1,640	1,160	1,320	100
NRH2410T 2R2MN	RoHS	2.2	±20%	77	0.150	1,290	1,340	970	1,110	100
NRH2410T 3R3MN	RoHS	3.3	±20%	56	0.220	1,000	1,140	770	890	100
NRH2410T 4R7MN	RoHS	4.7	±20%	50	0.290	880	930	670	780	100
NRH2410T 6R8MN	RoHS	6.8	±20%	43	0.410	750	765	570	650	100
NRH2410T 100MN	RoHS	10	±20%	32	0.690	550	605	450	520	100
NRH2410T 150MN	RoHS	15	±20%	27	1.02	470	520	370	430	100
NRH2410T 220MN	RoHS	22	±20%	22	1.47	390	405	300	340	100

● NRH2412 Shielded type

Parts number	EHS	Nominal inductance [μH]	Inductance tolerance	Self-resonant frequency [MHz] (min.)	DC Resistance [Ω] (±20%)	Rated current ※) [mA]				Measuring frequency [kHz]
						Saturation current: Idc1		Temperature rise current: Idc2		
						Max.	Typ.	Max.	Typ.	
NRH2412T R47NNGJ	RoHS	0.47	±30%	180	0.050	2,900	3,690	2,100	2,300	100
NRH2412T 1R0NNGH	RoHS	1.0	±30%	101	0.077	2,350	2,610	1,300	1,540	100
NRH2412T 1R5NNGH	RoHS	1.5	±30%	89	0.100	2,100	2,290	1,150	1,390	100
NRH2412T 2R2MNGH	RoHS	2.2	±20%	72	0.140	1,700	1,940	1,000	1,190	100
NRH2412T 3R3MNGH	RoHS	3.3	±20%	56	0.225	1,400	1,600	750	890	100
NRH2412T 4R7MNGH	RoHS	4.7	±20%	45	0.300	1,150	1,280	650	770	100
NRH2412T 6R8MNGH	RoHS	6.8	±20%	34	0.420	950	1,100	550	635	100
NRH2412T 100MNGH	RoHS	10	±20%	29	0.600	810	900	450	510	100

● NRH3010 Shielded type

Parts number	EHS	Nominal inductance [μH]	Inductance tolerance	Self-resonant frequency [MHz] (min.)	DC Resistance [Ω] (±20%)	Rated current ※) [mA]				Measuring frequency [kHz]
						Saturation current: Idc1		Temperature rise current: Idc2		
						Max.	Typ.	Max.	Typ.	
NRH3010T 1R2NN	RoHS	1.2	±30%	120	0.065	1,700	1,740	1,480	1,850	100
NRH3010T 1R5NN	RoHS	1.5	±30%	99	0.075	1,440	1,500	1,370	1,680	100
NRH3010T 2R2MN	RoHS	2.2	±20%	86	0.083	1,300	1,400	1,300	1,550	100
NRH3010T 3R3MN	RoHS	3.3	±20%	64	0.130	1,000	1,020	1,030	1,220	100
NRH3010T 4R7MN	RoHS	4.7	±20%	50	0.170	850	930	900	1,090	100
NRH3010T 6R8MN	RoHS	6.8	±20%	44	0.250	700	750	745	920	100
NRH3010T 100MN	RoHS	10	±20%	34	0.350	600	650	620	780	100
NRH3010T 150MN	RoHS	15	±20%	25	0.550	450	520	480	600	100
NRH3010T 220MN	RoHS	22	±20%	22	0.770	380	440	410	510	100
NRH3010T 330MN	RoHS	33	±20%	20	1.250	290	360	350	440	100
NRH3010T 470MN	RoHS	47	±20%	17	2.050	250	300	285	320	100

※) The saturation current value (Idc1) is the DC current value having inductance decrease down to 30%. (at 20°C)

※) The temperature rise current value (Idc2) is the DC current value having temperature increase up to 40°C. (at 20°C)

※) The rated current is the DC current value that satisfies both of current value saturation current value and temperature rise current value.

▶ This catalog contains the typical specification only due to the limitation of space. When you consider the purchase of our products, please check our product specification sheets. For details of each product (characteristics graph, reliability information, precautions for use, and so on), see our website (<http://www.ty-top.com/>).

PARTS NUMBER

NRH3012 Shielded type

Parts number	EHS	Nominal inductance [μH]	Inductance tolerance	Self-resonant frequency [MHz] (min.)	DC Resistance [Ω] (±20%)	Rated current ※) [mA]				Measuring frequency [kHz]
						Saturation current: Idc1		Temperature rise current: Idc2		
						Max.	Typ.	Max.	Typ.	
NRH3012T R47NN	RoHS	0.47	±30%	160	0.033	2,600	3,200	1,900	2,280	100
NRH3012T 1R0NN	RoHS	1.0	±30%	111	0.048	2,200	2,500	1,710	1,970	100
NRH3012T 1R5NN	RoHS	1.5	±30%	95	0.055	1,700	1,900	1,600	1,750	100
NRH3012T 2R2MN	RoHS	2.2	±20%	78	0.075	1,500	1,750	1,370	1,600	100
NRH3012T 3R3MN	RoHS	3.3	±20%	61	0.100	1,200	1,500	1,210	1,480	100
NRH3012T 4R7MN	RoHS	4.7	±20%	50	0.130	1,000	1,200	1,060	1,280	100
NRH3012T 6R8MN	RoHS	6.8	±20%	43	0.190	850	910	890	1,000	100
NRH3012T 100MN	RoHS	10	±20%	32	0.270	730	780	720	850	100
NRH3012T 150MN	RoHS	15	±20%	26	0.450	530	650	570	680	100
NRH3012T 220MN	RoHS	22	±20%	22	0.630	500	550	500	590	100
NRH3012T 330MN	RoHS	33	±20%	18	0.960	360	430	450	510	100
NRH3012T 470MN	RoHS	47	±20%	16	1.340	280	380	380	430	100

NRV3012 Shielded type

Parts number	EHS	Nominal inductance [μH]	Inductance tolerance	Self-resonant frequency [MHz] (min.)	DC Resistance [Ω] (±20%)	Rated current ※) [mA]				Measuring frequency [kHz]
						Saturation current: Idc1		Temperature rise current: Idc2		
						Max.	Typ.	Max.	Typ.	
NRV3012T 1R0N	RoHS	1.0	±30%	110	0.065	2,500	3,000	1,600	1,970	100
NRV3012T 1R5N	RoHS	1.5	±30%	92	0.075	2,100	2,500	1,400	1,610	100
NRV3012T 2R2M	RoHS	2.2	±20%	70	0.120	1,800	2,100	1,100	1,330	100
NRV3012T 3R3M	RoHS	3.3	±20%	55	0.150	1,600	1,900	1,000	1,260	100
NRV3012T 4R7M	RoHS	4.7	±20%	48	0.190	1,250	1,500	850	1,040	100
NRV3012T 6R8M	RoHS	6.8	±20%	40	0.300	950	1,200	650	800	100
NRV3012T 100M	RoHS	10	±20%	32	0.470	800	990	550	640	100

NRS3015 Shielded type

Parts number	EHS	Nominal inductance [μH]	Inductance tolerance	Self-resonant frequency [MHz] (min.)	DC Resistance [Ω] (±20%)	Rated current ※) [mA]				Measuring frequency [kHz]
						Saturation current: Idc1		Temperature rise current: Idc2		
						Max.	Typ.	Max.	Typ.	
NRS3015T 1R0NNGH	RoHS	1.0	±30%	100	0.030	2,100	2,400	2,100	2,350	100
NRS3015T 1R5NNGH	RoHS	1.5	±30%	87	0.038	1,800	2,100	1,820	2,100	100
NRS3015T 2R2MNGH	RoHS	2.2	±20%	64	0.058	1,480	1,700	1,500	1,800	100
NRS3015T 3R3MNGH	RoHS	3.3	±20%	49	0.078	1,210	1,400	1,230	1,500	100
NRS3015T 4R7MNGH	RoHS	4.7	±20%	40	0.120	1,020	1,100	1,040	1,300	100
NRS3015T 6R8MNGH	RoHS	6.8	±20%	36	0.160	870	920	880	1,100	100
NRS3015T 100MNGH	RoHS	10	±20%	28	0.220	700	750	710	840	100
NRS3015T 150MNGH	RoHS	15	±20%	23	0.325	580	680	680	760	100
NRS3015T 220MNGH	RoHS	22	±20%	20	0.520	470	540	470	530	100
NRS3015T 330MNGH	RoHS	33	±20%	18	0.780	400	440	440	490	100
NRS3015T 470MNGH	RoHS	47	±20%	17	1.100	325	380	350	380	100

NRS4010 Shielded type

Parts number	EHS	Nominal inductance [μH]	Inductance tolerance	Self-resonant frequency [MHz] (min.)	DC Resistance [Ω] (±20%)	Rated current ※) [mA]				Measuring frequency [kHz]
						Saturation current: Idc1		Temperature rise current: Idc2		
						Max.	Typ.	Max.	Typ.	
NRS4010T 1R0NDGG	RoHS	1.0	±30%	116	0.056	2,000	2,280	1,900	2,390	100
NRS4010T 2R2MDGG	RoHS	2.2	±20%	73	0.085	1,200	1,610	1,500	1,800	100
NRS4010T 3R3MDGG	RoHS	3.3	±20%	58	0.100	1,100	1,300	1,400	1,700	100
NRS4010T 4R7MDGG	RoHS	4.7	±20%	47	0.140	950	1,100	1,200	1,450	100
NRS4010T 6R8MDGG	RoHS	6.8	±20%	38	0.200	800	890	1,000	1,200	100
NRS4010T 100MDGG	RoHS	10	±20%	31	0.300	620	760	750	860	100
NRS4010T 150MDGG	RoHS	15	±20%	24	0.430	540	635	600	700	100
NRS4010T 220MDGG	RoHS	22	±20%	19	0.570	450	540	500	600	100
NRS4010T 330MDGG	RoHS	33	±20%	15	0.900	350	440	400	460	100
NRS4010T 470MDGG	RoHS	47	±20%	13	1.250	300	350	350	370	100

NRS4012 Shielded type

Parts number	EHS	Nominal inductance [μH]	Inductance tolerance	Self-resonant frequency [MHz] (min.)	DC Resistance [Ω] (±20%)	Rated current ※) [mA]				Measuring frequency [kHz]
						Saturation current: Idc1		Temperature rise current: Idc2		
						Max.	Typ.	Max.	Typ.	
NRS4012T 1R0NDGG	RoHS	1.0	±30%	100	0.042	2,800	2,900	2,200	2,670	100
NRS4012T 1R5NDGG	RoHS	1.5	±30%	90	0.051	2,300	2,500	2,000	2,430	100
NRS4012T 2R2MDGJ	RoHS	2.2	±20%	70	0.060	1,650	1,950	1,900	2,100	100
NRS4012T 3R3MDGJ	RoHS	3.3	±20%	60	0.070	1,400	1,700	1,700	1,880	100
NRS4012T 4R7MDGJ	RoHS	4.7	±20%	45	0.095	1,200	1,320	1,500	1,570	100
NRS4012T 6R8MDGJ	RoHS	6.8	±20%	35	0.125	900	1,170	1,300	1,400	100
NRS4012T 100MDGJ	RoHS	10	±20%	30	0.170	800	990	1,100	1,200	100
NRS4012T 150MDGJ	RoHS	15	±20%	24	0.260	650	820	750	840	100
NRS4012T 220MDGJ	RoHS	22	±20%	18	0.400	500	620	620	650	100
NRS4012T 330MDGJ	RoHS	33	±20%	15	0.600	400	500	480	530	100
NRS4012T 470MDGJ	RoHS	47	±20%	12	0.770	350	430	420	470	100

※) The saturation current value (Idc1) is the DC current value having inductance decrease down to 30%. (at 20°C)

※) The temperature rise current value (Idc2) is the DC current value having temperature increase up to 40°C. (at 20°C)

※) The rated current is the DC current value that satisfies both of current value saturation current value and temperature rise current value.

▶ This catalog contains the typical specification only due to the limitation of space. When you consider the purchase of our products, please check our product specification sheets. For details of each product (characteristics graph, reliability information, precautions for use, and so on), see our website (<http://www.ty-top.com/>).

PARTS NUMBER

● NRS4018 Shielded type

Parts number	EHS	Nominal inductance [μH]	Inductance tolerance	Self-resonant frequency [MHz] (min.)	DC Resistance [Ω] (±20%)	Rated current ※) [mA]				Measuring frequency [kHz]
						Saturation current: Idc1		Temperature rise current: Idc2		
						Max.	Typ.	Max.	Typ.	
NRS4018T 1R0NDGJ	RoHS	1.0	±30%	90	0.027	4,000	4,590	3,200	3,720	100
NRS4018T 1R5NDGJ	RoHS	1.5	±30%	75	0.037	3,300	3,750	2,400	3,000	100
NRS4018T 2R2MDGJ	RoHS	2.2	±20%	60	0.042	3,000	3,110	2,200	2,590	100
NRS4018T 3R3MDGJ	RoHS	3.3	±20%	45	0.055	2,300	2,560	2,000	2,240	100
NRS4018T 4R7MDGJ	RoHS	4.7	±20%	35	0.070	2,000	2,330	1,700	1,880	100
NRS4018T 6R8MDGJ	RoHS	6.8	±20%	30	0.098	1,600	1,820	1,450	1,690	100
NRS4018T 100MDGJ	RoHS	10	±20%	25	0.150	1,300	1,440	1,200	1,250	100
NRS4018T 150MDGJ	RoHS	15	±20%	18	0.210	1,100	1,150	850	915	100
NRS4018T 220MDGJ	RoHS	22	±20%	15	0.290	900	920	720	810	100
NRS4018T 330MDGJ	RoHS	33	±20%	12	0.460	700	830	550	630	100
NRS4018T 470MDGJ	RoHS	47	±20%	10	0.650	600	700	440	520	100
NRS4018T 680MDGJ	RoHS	68	±20%	8.3	1.00	520	600	320	400	100
NRS4018T 101MDGJ	RoHS	100	±20%	6.5	1.45	420	490	280	330	100
NRS4018T 151MDGJ	RoHS	150	±20%	5.5	2.30	340	390	220	280	100
NRS4018T 221MDGJ	RoHS	220	±20%	4.0	3.80	275	310	170	210	100

● NRS5010 type

Parts number	EHS	Nominal inductance [μH]	Inductance tolerance	Self-resonant frequency [MHz] (min.)	DC Resistance [Ω] (±20%)	Rated current ※) [mA]				Measuring frequency [kHz]
						Saturation current: Idc1		Temperature rise current: Idc2		
						Max.	Typ.	Max.	Typ.	
NRS5010T 1R0NMGF	RoHS	1.0	±30%	95	0.070	2,350	2,510	1,750	2,000	100
NRS5010T 2R2NMGF	RoHS	2.2	±30%	65	0.105	1,500	1,710	1,400	1,600	100
NRS5010T 3R3MMGF	RoHS	3.3	±20%	42	0.125	1,400	1,530	1,250	1,520	100
NRS5010T 4R7MMGF	RoHS	4.7	±20%	37	0.145	1,200	1,340	1,150	1,390	100
NRS5010T 6R8MMGF	RoHS	6.8	±20%	33	0.185	1,000	1,120	1,000	1,210	100
NRS5010T 100MMGF	RoHS	10	±20%	23	0.250	850	970	900	950	100
NRS5010T 150MMGF	RoHS	15	±20%	19	0.400	680	740	650	700	100
NRS5010T 220MMGF	RoHS	22	±20%	15	0.600	550	620	450	560	100

● NRS5012 type

Parts number	EHS	Nominal inductance [μH]	Inductance tolerance	Self-resonant frequency [MHz] (min.)	DC Resistance [Ω] (±20%)	Rated current ※) [mA]				Measuring frequency [kHz]
						Saturation current: Idc1		Temperature rise current: Idc2		
						Max.	Typ.	Max.	Typ.	
NRS5012T 1R0NMGF	RoHS	1.0	±30%	100	0.053	4,500	4,670	2,300	2,750	100
NRS5012T 1R5NMGF	RoHS	1.5	±30%	86	0.070	3,800	3,970	2,200	2,470	100
NRS5012T 2R2MMGF	RoHS	2.2	±20%	70	0.085	3,100	3,510	2,000	2,300	100
NRS5012T 3R3MMGF	RoHS	3.3	±20%	48	0.160	2,400	2,580	1,450	1,650	100
NRS5012T 4R7MMGF	RoHS	4.7	±20%	40	0.180	2,200	2,320	1,400	1,560	100
NRS5012T 6R8MMGF	RoHS	6.8	±20%	36	0.260	1,700	1,950	1,100	1,260	100
NRS5012T 100MMGF	RoHS	10	±20%	26	0.420	1,400	1,550	850	1,000	100
NRS5012T 150MMGF	RoHS	15	±20%	22	0.670	1,200	1,240	640	740	100

● NRS5014 Shielded type

Parts number	EHS	Nominal inductance [μH]	Inductance tolerance	Self-resonant frequency [MHz] (min.)	DC Resistance [Ω] (±20%)	Rated current ※) [mA]				Measuring frequency [kHz]
						Saturation current: Idc1		Temperature rise current: Idc2		
						Max.	Typ.	Max.	Typ.	
NRS5014T R47NMGG	RoHS	0.47	±30%	185	0.025	5,800	6,400	3,300	3,470	100
NRS5014T 1R2NMGG	RoHS	1.2	±30%	86	0.045	3,800	4,200	2,400	3,000	100
NRS5014T 2R2NMGG	RoHS	2.2	±30%	56	0.065	2,800	3,100	2,000	2,400	100
NRS5014T 3R3NMGG	RoHS	3.3	±30%	48	0.080	2,350	2,650	1,700	2,200	100
NRS5014T 4R7NMGG	RoHS	4.7	±30%	41	0.100	2,050	2,400	1,400	1,900	100
NRS5014T 6R8MMGG	RoHS	6.8	±20%	33	0.150	1,600	1,850	1,200	1,450	100
NRS5014T 100MMGG	RoHS	10	±20%	27	0.200	1,400	1,600	1,050	1,250	100
NRS5014T 150MMGG	RoHS	15	±20%	20	0.320	1,100	1,300	650	790	100
NRS5014T 220MMGG	RoHS	22	±20%	16	0.450	900	1,000	550	660	100

● NRS5020 Shielded type

Parts number	EHS	Nominal inductance [μH]	Inductance tolerance	Self-resonant frequency [MHz] (min.)	DC Resistance [Ω] (±20%)	Rated current ※) [mA]				Measuring frequency [kHz]
						Saturation current: Idc1		Temperature rise current: Idc2		
						Max.	Typ.	Max.	Typ.	
NRS5020T R47NMGG	RoHS	0.47	±30%	230	0.012	6,100	6,900	5,000	5,800	100
NRS5020T 1R0NMGJ	RoHS	1.0	±30%	81	0.021	4,000	4,500	3,600	3,710	100
NRS5020T 1R5NMGJ	RoHS	1.5	±30%	68	0.026	3,350	3,800	3,200	3,540	100
NRS5020T 2R2NMGG	RoHS	2.2	±30%	57	0.035	2,900	3,200	2,900	3,200	100
NRS5020T 3R3NMGG	RoHS	3.3	±30%	46	0.048	2,400	2,700	2,400	3,080	100
NRS5020T 4R7MMGG	RoHS	4.7	±20%	37	0.060	2,000	2,270	2,000	2,370	100
NRS5020T 6R8MMGG	RoHS	6.8	±20%	30	0.090	1,600	1,850	1,650	2,200	100
NRS5020T 100MMGG	RoHS	10	±20%	24	0.120	1,300	1,480	1,450	1,850	100
NRS5020T 150MMGG	RoHS	15	±20%	20	0.165	1,100	1,260	1,200	1,480	100
NRS5020T 220MMGG	RoHS	22	±20%	17	0.260	900	1,100	1,000	1,230	100
NRS5020T 470MMGG	RoHS	47	±20%	12	0.435	630	750	560	610	100
NRS5020T 101MMGG	RoHS	100	±20%	7	0.850	420	510	400	450	100

※) The saturation current value (Idc1) is the DC current value having inductance decrease down to 30%. (at 20°C)

※) The temperature rise current value (Idc2) is the DC current value having temperature increase up to 40°C. (at 20°C)

※) The rated current is the DC current value that satisfies both of current value saturation current value and temperature rise current value.

▶ This catalog contains the typical specification only due to the limitation of space. When you consider the purchase of our products, please check our product specification sheets. For details of each product (characteristics graph, reliability information, precautions for use, and so on), see our website (<http://www.ty-top.com/>).

PARTS NUMBER

● NRS5024 Shielded type

Parts number	EHS	Nominal inductance [μH]	Inductance tolerance	Self-resonant frequency [MHz] (min.)	DC Resistance [Ω] (±20%)	Rated current ※) [mA]				Measuring frequency [kHz]
						Saturation current: Idc1		Temperature rise current: Idc2		
						Max.	Typ.	Max.	Typ.	
NRS5024T 1R0NMGJ	RoHS	1.0	±30%	85	0.016	5,800	6,800	4,400	4,900	100
NRS5024T 1R5NMGJ	RoHS	1.5	±30%	67	0.022	5,200	5,800	3,600	4,300	100
NRS5024T 2R2NMGJ	RoHS	2.2	±30%	51	0.029	4,100	4,800	3,100	3,600	100
NRS5024T 3R3NMGJ	RoHS	3.3	±30%	41	0.043	3,100	3,700	2,400	2,750	100
NRS5024T 4R7MMGJ	RoHS	4.7	±20%	37	0.055	2,700	3,400	2,000	2,400	100
NRS5024T 6R8MMGJ	RoHS	6.8	±20%	28	0.080	2,200	2,750	1,600	1,800	100
NRS5024T 100MMGJ	RoHS	10	±20%	21	0.125	1,700	2,100	1,200	1,460	100
NRS5024T 150MMGJ	RoHS	15	±20%	18	0.170	1,400	1,750	1,000	1,250	100
NRS5024T 220MMGJ	RoHS	22	±20%	15	0.230	1,200	1,450	820	900	100
NRS5024T 330MMGJ	RoHS	33	±20%	11	0.370	1,000	1,200	630	700	100

● NRS5030 Shielded type

Parts number	EHS	Nominal inductance [μH]	Inductance tolerance	Self-resonant frequency [MHz] (min.)	DC Resistance [Ω] (±30%)	Rated current ※) [mA]				Measuring frequency [kHz]
						Saturation current: Idc1		Temperature rise current: Idc2		
						Max.	Typ.	Max.	Typ.	
NRS5030T R47NMGJ	RoHS	0.47	±30%	185	0.010	9,000	9,400	5,000	5,900	100
NRS5030T 1R0NMGJ	RoHS	1.0	±30%	110	0.015	6,600	7,400	4,000	4,900	100
NRS5030T 2R2NMGJ	RoHS	2.2	±30%	46	0.023	4,200	5,000	3,500	4,100	100
NRS5030T 3R3MMGJ	RoHS	3.3	±20%	36	0.030	3,600	3,900	3,000	3,600	100
NRS5030T 4R7MMGJ	RoHS	4.7	±20%	31	0.035	3,100	3,500	2,600	3,000	100
NRS5030T 6R8MMGJ	RoHS	6.8	±20%	22	0.052	2,500	2,800	2,300	2,500	100
NRS5030T 100MMGJ	RoHS	10	±20%	20	0.070	2,100	2,300	1,700	2,000	100
NRS5030T 150MMGJ	RoHS	15	±20%	14	0.125	1,600	1,800	1,400	1,550	100
NRS5030T 220MMGJ	RoHS	22	±20%	13	0.180	1,400	1,500	1,050	1,200	100
NRS5030T 330MMGJ	RoHS	33	±20%	10	0.225	1,150	1,250	800	950	100
NRS5030T 470MMGJ	RoHS	47	±20%	9	0.325	950	1,050	700	800	100

● NRS5040 Shielded type

Parts number	EHS	Nominal inductance [μH]	Inductance tolerance	Self-resonant frequency [MHz] (min.)	DC Resistance [Ω] (±30%)	Rated current ※) [mA]				Measuring frequency [kHz]
						Saturation current: Idc1		Temperature rise current: Idc2		
						Max.	Typ.	Max.	Typ.	
NRS5040T 1R5NMGJ	RoHS	1.5	±30%	60	0.017	6,400	6,530	4,500	4,730	100
NRS5040T 2R2NMGJ	RoHS	2.2	±30%	42	0.022	5,000	5,250	3,700	4,080	100
NRS5040T 3R3NMGJ	RoHS	3.3	±30%	32	0.027	4,000	4,280	3,300	3,770	100
NRS5040T 4R7NMGK	RoHS	4.7	±30%	28	0.029	3,300	3,470	3,100	3,500	100
NRS5040T 6R8MMGJ	RoHS	6.8	±20%	21	0.049	2,800	2,910	2,400	2,470	100
NRS5040T 100MMGJ	RoHS	10	±20%	18	0.056	2,300	2,470	2,100	2,210	100
NRS5040T 150MMGJ	RoHS	15	±20%	13	0.080	2,000	2,150	1,800	1,920	100
NRS5040T 220MMGK	RoHS	22	±20%	9	0.126	1,500	1,580	1,400	1,470	100
NRS5040T 330MMGJ	RoHS	33	±20%	7	0.180	1,300	1,390	1,200	1,270	100
NRS5040T 470MMGJ	RoHS	47	±20%	6	0.310	1,100	1,150	900	950	100

● NRS6010 type

Parts number	EHS	Nominal inductance [μH]	Inductance tolerance	Self-resonant frequency [MHz] (min.)	DC Resistance [Ω] (±20%)	Rated current ※) [mA]				Measuring frequency [kHz]
						Saturation current: Idc1		Temperature rise current: Idc2		
						Max.	Typ.	Max.	Typ.	
NRS6010T 1R5MMGF	RoHS	1.5	±20%	77	0.090	2,400	2,650	1,900	2,150	100
NRS6010T 2R2MMGF	RoHS	2.2	±20%	56	0.110	1,900	2,120	1,700	1,950	100
NRS6010T 3R3MMGF	RoHS	3.3	±20%	42	0.135	1,600	1,750	1,500	1,750	100
NRS6010T 4R7MMGF	RoHS	4.7	±20%	36	0.165	1,300	1,470	1,400	1,600	100
NRS6010T 6R8MMGF	RoHS	6.8	±20%	30	0.220	1,200	1,300	1,200	1,320	100
NRS6010T 100MMGF	RoHS	10	±20%	25	0.270	1,000	1,100	1,100	1,200	100
NRS6010T 220MMGF	RoHS	22	±20%	12	0.580	650	720	700	740	100

● NRS6012 Shielded type

Parts number	EHS	Nominal inductance [μH]	Inductance tolerance	Self-resonant frequency [MHz] (min.)	DC Resistance [Ω] (±20%)	Rated current ※) [mA]				Measuring frequency [kHz]
						Saturation current: Idc1		Temperature rise current: Idc2		
						Max.	Typ.	Max.	Typ.	
NRS6012T 1R0NMGJ	RoHS	1.0	±30%	95	0.050	3,000	3,900	2,400	2,700	100
NRS6012T 1R5NMGJ	RoHS	1.5	±30%	69	0.067	2,600	3,500	2,100	2,300	100
NRS6012T 2R5NMGJ	RoHS	2.5	±30%	45	0.090	2,100	2,900	1,800	2,100	100
NRS6012T 3R3NMGJ	RoHS	3.3	±30%	42	0.105	1,800	2,500	1,700	1,950	100
NRS6012T 4R7MMGJ	RoHS	4.7	±20%	36	0.125	1,600	2,100	1,550	1,750	100
NRS6012T 5R3MMGJ	RoHS	5.3	±20%	34	0.125	1,500	1,750	1,550	1,750	100
NRS6012T 6R8MMGJ	RoHS	6.8	±20%	30	0.165	1,300	1,600	1,350	1,600	100
NRS6012T 100MMGJ	RoHS	10	±20%	22	0.200	1,000	1,400	1,200	1,380	100
NRS6012T 150MMGJ	RoHS	15	±20%	18	0.295	800	1,100	800	950	100
NRS6012T 220MMGJ	RoHS	22	±20%	12	0.465	760	900	650	750	100
NRS6012T 330MMGJ	RoHS	33	±20%	8	0.580	590	800	550	670	100
NRS6012T 470MMGJ	RoHS	47	±20%	6	0.965	520	630	460	540	100
NRS6012T 680MMGJ	RoHS	68	±20%	3	1.16	440	560	410	450	100
NRS6012T 101MMGJ	RoHS	100	±20%	1	1.67	350	490	320	380	100

※) The saturation current value (Idc1) is the DC current value having inductance decrease down to 30%. (at 20°C)

※) The temperature rise current value (Idc2) is the DC current value having temperature increase up to 40°C. (at 20°C)

※) The rated current is the DC current value that satisfies both of current value saturation current value and temperature rise current value.

PARTS NUMBER

● NRS6014 Shielded type

Parts number	EHS	Nominal inductance [μH]	Inductance tolerance	Self-resonant frequency [MHz] (min.)	DC Resistance [Ω] (±20%)	Rated current ※) [mA]				Measuring frequency [kHz]
						Saturation current: Idc1		Temperature rise current: Idc2		
						Max.	Typ.	Max.	Typ.	
NRS6014T 1R2NMG	RoHS	1.2	±30%	77	0.042	4,000	4,400	2,750	3,200	100
NRS6014T 2R2NMG	RoHS	2.2	±30%	61	0.055	3,000	3,500	2,300	2,600	100
NRS6014T 3R3NMG	RoHS	3.3	±30%	41	0.075	2,500	2,600	2,000	2,200	100
NRS6014T 4R7MMG	RoHS	4.7	±20%	36	0.090	2,000	2,170	1,900	1,950	100
NRS6014T 6R8MMG	RoHS	6.8	±20%	30	0.115	1,700	1,880	1,650	1,700	100
NRS6014T 100MMG	RoHS	10	±20%	24	0.140	1,400	1,540	1,400	1,500	100
NRS6014T 150MMG	RoHS	15	±20%	20	0.210	1,150	1,300	1,200	1,280	100
NRS6014T 220MMG	RoHS	22	±20%	16	0.300	950	1,100	1,000	1,090	100

● NRS6020 Shielded type

Parts number	EHS	Nominal inductance [μH]	Inductance tolerance	Self-resonant frequency [MHz] (min.)	DC Resistance [Ω] (±20%)	Rated current ※) [mA]				Measuring frequency [kHz]
						Saturation current: Idc1		Temperature rise current: Idc2		
						Max.	Typ.	Max.	Typ.	
NRS6020T 0R8NMG	RoHS	0.8	±30%	110	0.020	6,400	7,400	4,100	4,800	100
NRS6020T 1R5NMG	RoHS	1.5	±30%	93	0.026	4,300	5,300	3,600	4,200	100
NRS6020T 2R2NMG	RoHS	2.2	±30%	73	0.034	3,200	4,000	2,900	3,400	100
NRS6020T 3R3NMG	RoHS	3.3	±30%	55	0.040	2,800	3,400	2,750	3,100	100
NRS6020T 4R7NMG	RoHS	4.7	±30%	43	0.058	2,400	2,800	2,150	2,500	100
NRS6020T 6R8NMG	RoHS	6.8	±30%	30	0.085	2,000	2,600	1,800	2,100	100
NRS6020T 100MMG	RoHS	10	±20%	18	0.125	1,900	2,240	1,500	1,700	100
NRS6020T 220MMG	RoHS	22	±20%	11	0.290	1,250	1,470	950	1,100	100

● NRS6028 Shielded type

Parts number	EHS	Nominal inductance [μH]	Inductance tolerance	Self-resonant frequency [MHz] (min.)	DC Resistance [Ω] (±30%)	Rated current ※) [mA]				Measuring frequency [kHz]
						Saturation current: Idc1		Temperature rise current: Idc2		
						Max.	Typ.	Max.	Typ.	
NRS6028T 0R9NMG	RoHS	0.9	±30%	90	0.013	6,700	7,900	4,600	5,200	100
NRS6028T 1R5NMG	RoHS	1.5	±30%	78	0.016	5,100	6,100	4,200	4,700	100
NRS6028T 2R2NMG	RoHS	2.2	±30%	68	0.020	4,200	5,100	3,700	4,200	100
NRS6028T 3R0NMG	RoHS	3.0	±30%	55	0.023	3,600	4,300	3,400	3,900	100
NRS6028T 4R7NMG	RoHS	4.7	±20%	39	0.031	2,700	3,300	3,000	3,400	100
NRS6028T 6R8NMG	RoHS	6.8	±20%	25	0.043	2,600	3,000	2,500	2,900	100
NRS6028T 100MMG	RoHS	10	±20%	20	0.065	1,900	2,200	1,900	2,200	100
NRS6028T 150MMG	RoHS	15	±20%	17	0.095	1,600	1,900	1,800	1,900	100
NRS6028T 220MMG	RoHS	22	±20%	12	0.135	1,300	1,600	1,400	1,600	100
NRS6028T 330MMG	RoHS	33	±20%	10	0.220	1,100	1,300	1,100	1,250	100
NRS6028T 470MMG	RoHS	47	±20%	8	0.300	1,000	1,150	920	1,050	100
NRS6028T 680MMG	RoHS	68	±20%	5	0.420	800	950	770	880	100
NRS6028T 101MMG	RoHS	100	±20%	3	0.600	650	750	660	750	100

● NRS6045 Shielded type

Parts number	EHS	Nominal inductance [μH]	Inductance tolerance	Self-resonant frequency [MHz] (min.)	DC Resistance [Ω] (±30%)	Rated current ※) [mA]				Measuring frequency [kHz]
						Saturation current: Idc1		Temperature rise current: Idc2		
						Max.	Typ.	Max.	Typ.	
NRS6045T 1R0NMG	RoHS	1.0	±30%	110	0.014	9,800	11,000	4,500	5,200	100
NRS6045T 1R3NMG	RoHS	1.3	±30%	95	0.016	8,200	9,300	4,200	4,800	100
NRS6045T 1R5NMG	RoHS	1.5	±30%	95	0.016	8,200	9,300	4,200	4,800	100
NRS6045T 1R8NMG	RoHS	1.8	±30%	80	0.019	7,200	8,100	3,900	4,400	100
NRS6045T 2R2NMG	RoHS	2.2	±30%	60	0.022	6,400	7,300	3,600	4,100	100
NRS6045T 2R3NMG	RoHS	2.3	±30%	60	0.022	6,400	7,300	3,600	4,100	100
NRS6045T 3R0NMG	RoHS	3.0	±30%	45	0.024	5,600	6,500	3,300	4,000	100
NRS6045T 3R3NMG	RoHS	3.3	±30%	45	0.024	5,600	6,500	3,300	4,000	100
NRS6045T 4R5MMG	RoHS	4.5	±20%	25	0.030	4,400	5,400	3,100	3,600	100
NRS6045T 4R7NMG	RoHS	4.7	±30%	25	0.030	4,400	5,400	3,100	3,600	100
NRS6045T 6R3MMG	RoHS	6.3	±20%	15	0.036	3,600	4,300	3,000	3,300	100
NRS6045T 6R8MMG	RoHS	6.8	±20%	15	0.036	3,600	4,300	3,000	3,300	100
NRS6045T 100MMG	RoHS	10	±20%	12	0.046	3,100	3,600	2,400	2,800	100
NRS6045T 150MMG	RoHS	15	±20%	10	0.070	2,500	3,000	1,900	2,300	100
NRS6045T 220MMG	RoHS	22	±20%	7	0.107	2,000	2,400	1,600	1,900	100
NRS6045T 330MMG	RoHS	33	±20%	6	0.141	1,650	2,000	1,400	1,600	100
NRS6045T 470MMG	RoHS	47	±20%	5	0.211	1,400	1,600	1,150	1,350	100
NRS6045T 680MMG	RoHS	68	±20%	4	0.304	1,100	1,300	950	1,100	100
NRS6045T 101MMG	RoHS	100	±20%	3	0.466	900	1,200	750	900	100

※) The saturation current value (Idc1) is the DC current value having inductance decrease down to 30%. (at 20°C)

※) The temperature rise current value (Idc2) is the DC current value having temperature increase up to 40°C. (at 20°C)

※) The rated current is the DC current value that satisfies both of current value saturation current value and temperature rise current value.

▶ This catalog contains the typical specification only due to the limitation of space. When you consider the purchase of our products, please check our product specification sheets. For details of each product (characteristics graph, reliability information, precautions for use, and so on), see our website (<http://www.ty-top.com/>).

PARTS NUMBER

●NRS8030 Shielded type

Parts number	EHS	Nominal inductance [μ H]	Inductance tolerance	Self-resonant frequency [MHz] (min.)	DC Resistance [Ω] ($\pm 30\%$)	Rated current ※) [mA]				Measuring frequency[kHz]
						Saturation current: Idc1		Temperature rise current: Idc2		
						Max.	Typ.	Max.	Typ.	
NRS8030T 1R0NJGJ	RoHS	1.0	$\pm 30\%$	120	0.009	7,800	9,300	6,200	7,600	100
NRS8030T 1R5NJGJ	RoHS	1.5	$\pm 30\%$	80	0.012	6,200	7,800	5,300	6,400	100
NRS8030T 2R2NJGJ	RoHS	2.2	$\pm 30\%$	60	0.015	4,900	6,100	4,800	5,600	100
NRS8030T 3R3MJGJ	RoHS	3.3	$\pm 20\%$	50	0.019	4,200	5,200	4,300	5,100	100
NRS8030T 4R7MJGJ	RoHS	4.7	$\pm 20\%$	40	0.022	3,600	4,400	4,000	4,700	100
NRS8030T 6R8MJGJ	RoHS	6.8	$\pm 20\%$	32	0.029	3,000	3,600	3,400	4,000	100
NRS8030T 100MJGJ	RoHS	10	$\pm 20\%$	27	0.033	2,400	2,900	3,000	3,600	100
NRS8030T 150MJGJ	RoHS	15	$\pm 20\%$	20	0.060	2,000	2,300	2,200	2,600	100
NRS8030T 220MJGJ	RoHS	22	$\pm 20\%$	16	0.070	1,750	2,200	1,900	2,300	100
NRS8030T 330MJGJ	RoHS	33	$\pm 20\%$	13	0.120	1,300	1,600	1,500	1,800	100
NRS8030T 470MJGJ	RoHS	47	$\pm 20\%$	11	0.170	1,100	1,400	1,300	1,500	100

●NRS8040 Shielded type

Parts number	EHS	Nominal inductance [μ H]	Inductance tolerance	Self-resonant frequency [MHz] (min.)	DC Resistance [Ω] ($\pm 30\%$)	Rated current ※) [mA]				Measuring frequency[kHz]
						Saturation current: Idc1		Temperature rise current: Idc2		
						Max.	Typ.	Max.	Typ.	
NRS8040T 0R9NJGJ	RoHS	0.9	$\pm 30\%$	85	0.006	13,000	14,000	7,800	9,600	100
NRS8040T 1R0NJGJ	RoHS	1	$\pm 30\%$	85	0.006	13,000	14,000	7,800	9,600	100
NRS8040T 1R4NJGJ	RoHS	1.4	$\pm 30\%$	63	0.007	10,000	11,000	7,000	8,400	100
NRS8040T 1R5NJGJ	RoHS	1.5	$\pm 30\%$	63	0.007	10,000	11,000	7,000	8,400	100
NRS8040T 2R0NJGJ	RoHS	2.0	$\pm 30\%$	50	0.009	8,100	9,200	6,300	7,600	100
NRS8040T 2R2NJGJ	RoHS	2.2	$\pm 30\%$	50	0.009	8,100	9,200	6,300	7,600	100
NRS8040T 3R3NJGJ	RoHS	3.3	$\pm 30\%$	34	0.015	6,400	6,800	4,900	6,000	100
NRS8040T 3R6NJGJ	RoHS	3.6	$\pm 30\%$	34	0.015	6,400	6,800	4,900	6,000	100
NRS8040T 4R7NJGJ	RoHS	4.7	$\pm 30\%$	30	0.018	5,400	5,900	4,100	5,200	100
NRS8040T 6R8NJGJ	RoHS	6.8	$\pm 30\%$	24	0.025	4,400	4,800	3,700	4,400	100
NRS8040T 100MJGJ	RoHS	10	$\pm 20\%$	22	0.034	3,800	4,100	3,100	3,500	100
NRS8040T 150MJGJ	RoHS	15	$\pm 20\%$	16	0.050	2,900	3,200	2,400	3,000	100
NRS8040T 220MJGJ	RoHS	22	$\pm 20\%$	13	0.066	2,400	2,700	2,200	2,600	100
NRS8040T 330MJGK	RoHS	33	$\pm 20\%$	12	0.100	2,000	2,300	1,700	1,900	100
NRS8040T 470MJGK	RoHS	47	$\pm 20\%$	8	0.140	1,500	1,800	1,500	1,600	100
NRS8040T 680MJGK	RoHS	68	$\pm 20\%$	7	0.210	1,300	1,500	1,200	1,300	100
NRS8040T 101MJGK	RoHS	100	$\pm 20\%$	6	0.280	1,100	1,300	1,000	1,100	100
NRS8040T 151MJGK	RoHS	150	$\pm 20\%$	5	0.420	900	980	800	890	100
NRS8040T 221MJGK	RoHS	220	$\pm 20\%$	4	0.620	700	800	670	740	100

●NR 3010 Shielded type

Parts number	EHS	Nominal inductance [μ H]	Inductance tolerance	Self-resonant frequency [MHz] (min.)	DC Resistance [Ω] ($\pm 20\%$)	Rated current ※) [mA]		Measuring frequency[kHz]
						Saturation current: Idc1	Temperature rise current: Idc2	
						Max.	Max.	
NR 3010T 1R0N	RoHS	1.0	$\pm 30\%$	126	0.065	1,300	1,400	100
NR 3010T 1R5N	RoHS	1.5	$\pm 30\%$	98	0.080	1,200	1,300	100
NR 3010T 2R2M	RoHS	2.2	$\pm 20\%$	82	0.095	1,100	1,100	100
NR 3010T 3R3M	RoHS	3.3	$\pm 20\%$	63	0.140	870	940	100
NR 3010T 4R7M	RoHS	4.7	$\pm 20\%$	56	0.190	750	780	100
NR 3010T 6R8M	RoHS	6.8	$\pm 20\%$	46	0.300	610	630	100
NR 3010T 100M	RoHS	10	$\pm 20\%$	35	0.450	500	510	100
NR 3010T 150M	RoHS	15	$\pm 20\%$	30	0.740	400	400	100
NR 3010T 220M	RoHS	22	$\pm 20\%$	25	1.03	350	350	100
NR 3010T 330M	RoHS	33	$\pm 20\%$	20	1.55	260	275	100
NR 3010T 470M	RoHS	47	$\pm 20\%$	17	2.05	220	235	100

●NR 3012 Shielded type

Parts number	EHS	Nominal inductance [μ H]	Inductance tolerance	Self-resonant frequency [MHz] (min.)	DC Resistance [Ω] ($\pm 20\%$)	Rated current ※) [mA]		Measuring frequency[kHz]
						Saturation current: Idc1	Temperature rise current: Idc2	
						Max.	Max.	
NR 3012T 1R0N	RoHS	1.0	$\pm 30\%$	110	0.050	1,500	1,490	100
NR 3012T 1R5N	RoHS	1.5	$\pm 30\%$	92	0.060	1,360	1,400	100
NR 3012T 2R2M	RoHS	2.2	$\pm 20\%$	70	0.080	1,100	1,200	100
NR 3012T 3R3M	RoHS	3.3	$\pm 20\%$	55	0.100	910	1,050	100
NR 3012T 4R7M	RoHS	4.7	$\pm 20\%$	48	0.130	770	980	100
NR 3012T 6R8M	RoHS	6.8	$\pm 20\%$	40	0.190	670	740	100
NR 3012T 100M	RoHS	10	$\pm 20\%$	32	0.290	540	630	100
NR 3012T 150M	RoHS	15	$\pm 20\%$	27	0.450	440	485	100
NR 3012T 220M	RoHS	22	$\pm 20\%$	22	0.630	375	420	100
NR 3012T 330M	RoHS	33	$\pm 20\%$	19	1.03	310	330	100
NR 3012T 470M	RoHS	47	$\pm 20\%$	17	1.45	250	280	100

※) The saturation current value (Idc1) is the DC current value having inductance decrease down to 30%. (at 20°C)

※) The temperature rise current value (Idc2) is the DC current value having temperature increase up to 40°C. (at 20°C)

※) The rated current is the DC current value that satisfies both of current value saturation current value and temperature rise current value.

PARTS NUMBER

● NR 3015 Shielded type

Parts number	EHS	Nominal inductance [μ H]	Inductance tolerance	Self-resonant frequency [MHz] (min.)	DC Resistance [Ω] ($\pm 20\%$)	Rated current ※) [mA]		Measuring frequency [kHz]
						Saturation current: Idc1 Max.	Temperature rise current: Idc2 Max.	
NR 3015T 1R0N	RoHS	1.0	$\pm 30\%$	100	0.030	2,100	2,100	100
NR 3015T 1R5N	RoHS	1.5	$\pm 30\%$	87	0.040	1,800	1,820	100
NR 3015T 2R2M	RoHS	2.2	$\pm 20\%$	64	0.060	1,480	1,500	100
NR 3015T 3R3M	RoHS	3.3	$\pm 20\%$	49	0.080	1,210	1,230	100
NR 3015T 4R7M	RoHS	4.7	$\pm 20\%$	40	0.120	1,020	1,040	100
NR 3015T 6R8M	RoHS	6.8	$\pm 20\%$	36	0.160	870	880	100
NR 3015T 100M	RoHS	10	$\pm 20\%$	28	0.230	700	710	100
NR 3015T 150M	RoHS	15	$\pm 20\%$	23	0.360	560	560	100
NR 3015T 220M	RoHS	22	$\pm 20\%$	20	0.520	470	470	100
NR 3015T 330M	RoHS	33	$\pm 20\%$	18	0.840	390	370	100
NR 3015T 470M	RoHS	47	$\pm 20\%$	17	1.34	320	300	100

● NR 4010 Shielded type

Parts number	EHS	Nominal inductance [μ H]	Inductance tolerance	Self-resonant frequency [MHz] (min.)	DC Resistance [Ω] ($\pm 20\%$)	Rated current ※) [mA]		Measuring frequency [kHz]
						Saturation current: Idc1 Max.	Temperature rise current: Idc2 Max.	
NR 4010T 1R0N	RoHS	1.0	$\pm 30\%$	116	0.100	1,800	1,050	100
NR 4010T 2R2N	RoHS	2.2	$\pm 30\%$	73	0.150	1,150	890	100
NR 4010T 3R3M	RoHS	3.3	$\pm 20\%$	58	0.180	1,100	820	100
NR 4010T 4R7M	RoHS	4.7	$\pm 20\%$	47	0.210	900	750	100
NR 4010T 6R8M	RoHS	6.8	$\pm 20\%$	38	0.300	740	620	100
NR 4010T 100M	RoHS	10	$\pm 20\%$	31	0.380	560	600	100
NR 4010T 150M	RoHS	15	$\pm 20\%$	24	0.510	470	510	100
NR 4010T 220M	RoHS	22	$\pm 20\%$	19	0.870	360	400	100
NR 4010T 330M	RoHS	33	$\pm 20\%$	15	1.54	280	300	100
NR 4010T 470M	RoHS	47	$\pm 20\%$	13	1.81	240	280	100

● NR 4012 Shielded type

Parts number	EHS	Nominal inductance [μ H]	Inductance tolerance	Self-resonant frequency [MHz] (min.)	DC Resistance [Ω] ($\pm 20\%$)	Rated current ※) [mA]		Measuring frequency [kHz]
						Saturation current: Idc1 Max.	Temperature rise current: Idc2 Max.	
NR 4012T 1R0N	RoHS	1.0	$\pm 30\%$	131	0.060	2,500	1,500	100
NR 4012T 2R2M	RoHS	2.2	$\pm 20\%$	66	0.090	1,650	1,200	100
NR 4012T 3R3M	RoHS	3.3	$\pm 20\%$	50	0.130	1,200	980	100
NR 4012T 4R7M	RoHS	4.7	$\pm 20\%$	45	0.140	1,050	960	100
NR 4012T 6R8M	RoHS	6.8	$\pm 20\%$	35	0.180	900	840	100
NR 4012T 100M	RoHS	10	$\pm 20\%$	28	0.240	740	770	100
NR 4012T 150M	RoHS	15	$\pm 20\%$	23	0.400	560	600	100
NR 4012T 220M	RoHS	22	$\pm 20\%$	18	0.480	510	540	100
NR 4012T 330M	RoHS	33	$\pm 20\%$	15	0.810	400	420	100
NR 4012T 470M	RoHS	47	$\pm 20\%$	12	1.00	350	370	100

● NR 4018 Shielded type

Parts number	EHS	Nominal inductance [μ H]	Inductance tolerance	Self-resonant frequency [MHz] (min.)	DC Resistance [Ω] ($\pm 20\%$)	Rated current ※) [mA]		Measuring frequency [kHz]
						Saturation current: Idc1 Max.	Temperature rise current: Idc2 Max.	
NR 4018T 1R0N	RoHS	1.0	$\pm 30\%$	80	0.030	4,000	1,830	100
NR 4018T 2R2M	RoHS	2.2	$\pm 20\%$	52	0.060	2,700	1,440	100
NR 4018T 3R3M	RoHS	3.3	$\pm 20\%$	44	0.070	2,000	1,230	100
NR 4018T 4R7M	RoHS	4.7	$\pm 20\%$	34	0.090	1,700	1,200	100
NR 4018T 6R8M	RoHS	6.8	$\pm 20\%$	29	0.110	1,450	1,060	100
NR 4018T 100M	RoHS	10	$\pm 20\%$	24	0.180	1,200	840	100
NR 4018T 150M	RoHS	15	$\pm 20\%$	19	0.250	940	650	100
NR 4018T 220M	RoHS	22	$\pm 20\%$	16	0.360	800	590	100
NR 4018T 330M	RoHS	33	$\pm 20\%$	12	0.530	650	490	100
NR 4018T 470M	RoHS	47	$\pm 20\%$	10	0.650	570	420	100
NR 4018T 680M	RoHS	68	$\pm 20\%$	8.3	1.00	470	320	100
NR 4018T 101M	RoHS	100	$\pm 20\%$	6.5	1.50	400	270	100
NR 4018T 151M	RoHS	150	$\pm 20\%$	5.5	2.50	310	220	100
NR 4018T 221M	RoHS	220	$\pm 20\%$	4.0	4.00	270	170	100

● NR 5040 Shielded type

Parts number	EHS	Nominal inductance [μ H]	Inductance tolerance	Self-resonant frequency [MHz] (min.)	DC Resistance [Ω] ($\pm 30\%$)	Rated current ※) [mA]		Measuring frequency [kHz]
						Saturation current: Idc1 Max.	Temperature rise current: Idc2 Max.	
NR 5040T 1R5N	RoHS	1.5	$\pm 30\%$	60	0.020	6,000	3,600	100
NR 5040T 2R2N	RoHS	2.2	$\pm 30\%$	42	0.022	4,600	3,500	100
NR 5040T 3R3N	RoHS	3.3	$\pm 30\%$	32	0.027	3,800	3,300	100
NR 5040T 4R7N	RoHS	4.7	$\pm 30\%$	28	0.029	3,300	3,100	100
NR 5040T 6R8M	RoHS	6.8	$\pm 20\%$	21	0.049	2,600	2,300	100
NR 5040T 100M	RoHS	10	$\pm 20\%$	18	0.056	2,300	2,100	100
NR 5040T 150M	RoHS	15	$\pm 20\%$	13	0.080	2,000	1,800	100
NR 5040T 220M	RoHS	22	$\pm 20\%$	9	0.126	1,600	1,400	100
NR 5040T 330M	RoHS	33	$\pm 20\%$	7	0.180	1,300	1,200	100
NR 5040T 470M	RoHS	47	$\pm 20\%$	6	0.310	1,100	900	100

※) The saturation current value (Idc1) is the DC current value having inductance decrease down to 30%. (at 20°C)

※) The temperature rise current value (Idc2) is the DC current value having temperature increase up to 40°C. (at 20°C)

※) The rated current is the DC current value that satisfies both of current value saturation current value and temperature rise current value.

► This catalog contains the typical specification only due to the limitation of space. When you consider the purchase of our products, please check our product specification sheets. For details of each product (characteristics graph, reliability information, precautions for use, and so on), see our website (<http://www.ty-top.com/>).

PARTS NUMBER

NR 6012 Shielded type

Parts number	EHS	Nominal inductance [μH]	Inductance tolerance	Self-resonant frequency [MHz] (min.)	DC Resistance [Ω] (±20%)	Rated current ※) [mA]		Measuring frequency [kHz]
						Saturation current: Idc1 Max.	Temperature rise current: Idc2 Max.	
NR 6012T 2R5NE	RoHS	2.5	±30%	45	0.090	2,100	1,730	100
NR 6012T 4R0NE	RoHS	4.0	±30%	39	0.105	1,800	1,570	100
NR 6012T 5R3ME	RoHS	5.3	±20%	34	0.125	1,500	1,400	100
NR 6012T 6R8ME	RoHS	6.8	±20%	30	0.165	1,300	1,180	100
NR 6012T 100ME	RoHS	10	±20%	22	0.235	1,000	1,000	100
NR 6012T 150ME	RoHS	15	±20%	18	0.330	800	790	100
NR 6012T 220ME	RoHS	22	±20%	12	0.530	760	630	100
NR 6012T 330ME	RoHS	33	±20%	8	0.700	590	530	100
NR 6012T 470ME	RoHS	47	±20%	6	1.05	520	460	100
NR 6012T 680ME	RoHS	68	±20%	3	1.35	440	410	100
NR 6012T 101ME	RoHS	100	±20%	1	2.18	350	320	100

NR 6020 Shielded type

Parts number	EHS	Nominal inductance [μH]	Inductance tolerance	Self-resonant frequency [MHz] (min.)	DC Resistance [Ω] (±20%)	Rated current ※) [mA]		Measuring frequency [kHz]
						Saturation current: Idc1 Max.	Temperature rise current: Idc2 Max.	
NR 6020T 0R8N	RoHS	0.8	±30%	110	0.020	5,500	3,800	100
NR 6020T 1R5N	RoHS	1.5	±30%	93	0.026	4,000	3,200	100
NR 6020T 2R2N	RoHS	2.2	±30%	73	0.034	3,200	2,700	100
NR 6020T 3R3N	RoHS	3.3	±30%	55	0.040	2,800	2,600	100
NR 6020T 4R7N	RoHS	4.7	±30%	43	0.058	2,400	2,000	100
NR 6020T 6R8N	RoHS	6.8	±30%	30	0.085	2,000	1,800	100
NR 6020T 100M	RoHS	10	±20%	18	0.125	1,700	1,400	100
NR 6020T 220M	RoHS	22	±20%	11	0.290	1,050	950	100

NR 6028 Shielded type

Parts number	EHS	Nominal inductance [μH]	Inductance tolerance	Self-resonant frequency [MHz] (min.)	DC Resistance [Ω] (±30%)	Rated current ※) [mA]		Measuring frequency [kHz]
						Saturation current: Idc1 Max.	Temperature rise current: Idc2 Max.	
NR 6028T 0R9N	RoHS	0.9	±30%	90	0.013	6,600	4,600	100
NR 6028T 1R5N	RoHS	1.5	±30%	78	0.016	5,000	4,200	100
NR 6028T 2R2N	RoHS	2.2	±30%	68	0.020	4,200	3,700	100
NR 6028T 3R0N	RoHS	3.0	±30%	55	0.023	3,600	3,400	100
NR 6028T 4R7M	RoHS	4.7	±20%	39	0.031	2,700	3,000	100
NR 6028T 6R0M	RoHS	6.0	±20%	30	0.040	2,500	2,500	100
NR 6028T 100M	RoHS	10	±20%	20	0.065	1,900	1,900	100
NR 6028T 150M	RoHS	15	±20%	17	0.095	1,600	1,800	100
NR 6028T 220M	RoHS	22	±20%	12	0.135	1,300	1,400	100
NR 6028T 330M	RoHS	33	±20%	10	0.220	1,100	1,100	100
NR 6028T 470M	RoHS	47	±20%	8	0.300	950	920	100
NR 6028T 680M	RoHS	68	±20%	5	0.420	760	770	100
NR 6028T 101M	RoHS	100	±20%	3	0.600	620	660	100

NR 6045 Shielded type

Parts number	EHS	Nominal inductance [μH]	Inductance tolerance	Self-resonant frequency [MHz] (min.)	DC Resistance [Ω] (±30%)	Rated current ※) [mA]		Measuring frequency [kHz]
						Saturation current: Idc1 Max.	Temperature rise current: Idc2 Max.	
NR 6045T 1R0N	RoHS	1.0	±30%	110	0.014	8,500	4,200	100
NR 6045T 1R3N	RoHS	1.3	±30%	95	0.016	8,000	4,000	100
NR 6045T 1R8N	RoHS	1.8	±30%	80	0.018	7,000	3,700	100
NR 6045T 2R3N	RoHS	2.3	±30%	60	0.021	6,000	3,500	100
NR 6045T 3R0N	RoHS	3.0	±30%	45	0.024	5,000	3,200	100
NR 6045T 4R5M	RoHS	4.5	±20%	25	0.031	4,000	3,000	100
NR 6045T 6R3M	RoHS	6.3	±20%	15	0.038	3,800	2,800	100
NR 6045T 100M	RoHS	10	±20%	12	0.047	3,000	2,500	100
NR 6045T 150M	RoHS	15	±20%	10	0.077	2,300	1,900	100
NR 6045T 220M	RoHS	22	±20%	7	0.115	1,900	1,500	100
NR 6045T 330M	RoHS	33	±20%	6	0.145	1,500	1,400	100
NR 6045T 470M	RoHS	47	±20%	5	0.220	1,300	1,100	100
NR 6045T 680M	RoHS	68	±20%	4	0.330	1,000	900	100
NR 6045T 101M	RoHS	100	±20%	3	0.500	800	700	100

NR 8040 Shielded type

Parts number	EHS	Nominal inductance [μH]	Inductance tolerance	Self-resonant frequency [MHz] (min.)	DC Resistance [Ω] (±30%)	Rated current ※) [mA]		Measuring frequency [kHz]
						Saturation current: Idc1 Max.	Temperature rise current: Idc2 Max.	
NR 8040T 0R9N	RoHS	0.9	±30%	85	0.006	11,000	7,800	100
NR 8040T 1R4N	RoHS	1.4	±30%	63	0.007	9,000	7,000	100
NR 8040T 2R0N	RoHS	2.0	±30%	50	0.009	7,400	6,300	100
NR 8040T 3R6N	RoHS	3.6	±30%	34	0.015	5,300	4,900	100
NR 8040T 4R7N	RoHS	4.7	±30%	30	0.018	4,700	4,100	100
NR 8040T 6R8N	RoHS	6.8	±30%	24	0.025	4,000	3,700	100
NR 8040T 100M	RoHS	10	±20%	22	0.034	3,400	3,100	100
NR 8040T 150M	RoHS	15	±20%	16	0.050	2,700	2,400	100
NR 8040T 220M	RoHS	22	±20%	13	0.066	2,200	2,200	100
NR 8040T 330M	RoHS	33	±20%	12	0.100	1,900	1,700	100
NR 8040T 470M	RoHS	47	±20%	8	0.150	1,500	1,400	100
NR 8040T 680M	RoHS	68	±20%	7	0.230	1,200	1,100	100
NR 8040T 101M	RoHS	100	±20%	6	0.290	1,000	1,000	100

※) The saturation current value (Idc1) is the DC current value having inductance decrease down to 30%. (at 20°C)

※) The temperature rise current value (Idc2) is the DC current value having temperature increase up to 40°C. (at 20°C)

※) The rated current is the DC current value that satisfies both of current value saturation current value and temperature rise current value.

► This catalog contains the typical specification only due to the limitation of space. When you consider the purchase of our products, please check our product specification sheets. For details of each product (characteristics graph, reliability information, precautions for use, and so on), see our website (<http://www.ty-top.com/>).

SMD POWER INDUCTORS (NR SERIES/NR SERIES H TYPE/M TYPE/S TYPE/V TYPE)

PACKAGING

① Minimum Quantity

Type	Standard Quantity [pcs]
	Tape & Reel
NRV2010	2500
NRS2012	2500
NRV2012	2500
NRH2410	2500
NRH2412	2500
NR 3010	2000
NRH3010	2000
NR 3012	2000
NRH3012	2000
NRV3012	2000
NR 3015	2000
NRS3015	2000
NR 4010	5000
NRS4010	5000
NR 4012	4500
NRS4012	4500
NR 4018	3500
NRS4018	3500

Type	Standard Quantity [pcs]
	Tape & Reel
NRS5010	1000
NRS5012	1000
NRS5014	1000
NRS5020	800
NRS5024	2500
NRS5030	500
NR 5040	1500
NRS5040	1500
NRS6010	1000
NR 6012	1000
NRS6012	1000
NRS6014	1000
NR 6020	2500
NRS6020	2500
NR 6028	2000
NRS6028	2000
NR 6045	1500
NRM6045	1500
NRS6045	1500
NRS8030	1000
NR 8040	1000
NRS8040	1000

② Tape Material

● Embossed Tape



③ Taping dimensions

● Embossed tape 8mm wide (0.315 inches wide)



▶ This catalog contains the typical specification only due to the limitation of space. When you consider the purchase of our products, please check our specification. For details of each product (characteristics graph, reliability information, precautions for use, and so on), see our Web site (<http://www.ty-top.com/>).

Type	Chip cavity		Insertion pitch	Tape thickness	
	A	B		T	K
NRV2010	2.2±0.1 (0.102±0.004)	2.2±0.1 (0.102±0.004)	4.0±0.1 (0.157±0.004)	0.25±0.05 (0.009±0.002)	1.3±0.1 (0.051±0.004)
NRS2012 NRV2012					
NRH2410	2.6±0.1 (0.087±0.004)	2.6±0.1 (0.102±0.004)		0.25±0.05 (0.009±0.002)	1.3±0.1 (0.051±0.004)
NRH2412					
NR 3010 NRH3010	3.2±0.1 (0.126±0.004)	3.2±0.1 (0.126±0.004)		0.3±0.05 (0.012±0.002)	1.4±0.1 (0.055±0.004)
NR 3012 NRH3012 NRV3012					1.6±0.1 (0.063±0.004)
NR 3015 NRS3015			1.9±0.1 (0.075±0.004)		

Unit : mm (inch)

● Embossed tape 12mm wide (0.47 inches wide)



Type	Chip cavity		Insertion pitch	Tape thickness		
	A	B		T	K	
NR 4010 NRS4010	4.3±0.1 (0.169±0.004)	4.3±0.1 (0.169±0.004)	8.0±0.1 (0.315±0.004)	0.3±0.1 (0.012±0.004)	1.4±0.1 (0.055±0.004)	
NR 4012 NRS4012					1.6±0.1 (0.063±0.004)	
NR 4018 NRS4018	2.1±0.1 (0.083±0.004)					
NRS5010	5.25±0.1 (0.207±0.004)	5.25±0.1 (0.207±0.004)			1.4±0.1 (0.055±0.004)	
NRS5012						1.4±0.1 (0.055±0.004)
NRS5014						1.6±0.1 (0.063±0.004)
NRS5020				2.3±0.1 (0.091±0.004)		
NRS5024	5.15±0.1 (0.203±0.004)	5.15±0.1 (0.203±0.004)		2.7±0.1 (0.106±0.004)		
NRS5030					3.2±0.1 (0.126±0.004)	
NR 5040 NRS5040					4.2±0.1 (0.165±0.004)	
NRS6010					6.3±0.1 (0.248±0.004)	6.3±0.1 (0.248±0.004)
NR 6012 NRS6012	1.6±0.1 (0.063±0.004)					
NRS6014	1.6±0.1 (0.063±0.004)					
NR 6020 NRS6020	2.3±0.1 (0.090±0.004)					
NR 6028 NRS6028	3.1±0.1 (0.122±0.004)					
NR 6045 NRM6045 NRS6045	4.7±0.1 (0.185±0.004)					

Unit : mm (inch)

▶ This catalog contains the typical specification only due to the limitation of space. When you consider the purchase of our products, please check our specification. For details of each product (characteristics graph, reliability information, precautions for use, and so on), see our Web site (<http://www.ty-top.com/>).

● Embossed tape 16mm wide (0.63 inches wide)



Type	Chip cavity		Insertion pitch F	Tape thickness	
	A	B		T	K
NRS8030	8.3 ± 0.1 (0.327 ± 0.004)	8.3 ± 0.1 (0.327 ± 0.004)	12.0 ± 0.1 (0.472 ± 0.004)	0.5 ± 0.1 (0.020 ± 0.004)	3.4 ± 0.1 (0.134 ± 0.004)
NR 8040 NRS8040					4.5 ± 0.1 (0.177 ± 0.004)

Unit: mm (inch)

④ Leader and Blank portion

● NR, NRH, NRS, NRV



⑤ Reel size



Type	Reel size (Reference values)		
	ϕD	ϕd	W
NRV2010	180 ± 0.5 (7.087 ± 0.019)	60 ± 1.0 (2.36 ± 0.04)	10.0 ± 1.5 (0.394 ± 0.059)
NRS2012			
NRV2012			
NRH2410			
NRH2412			
NR 3010			
NRH3010			
NR 3012			
NRH3012			
NRV3012			
NR 3015	180 ± 0.5 (7.087 ± 0.019)	60 ± 1.0 (2.36 ± 0.04)	10.0 ± 1.5 (0.394 ± 0.059)
NRS3015			

▶ This catalog contains the typical specification only due to the limitation of space. When you consider the purchase of our products, please check our specification. For details of each product (characteristics graph, reliability information, precautions for use, and so on), see our Web site (<http://www.ty-top.com/>).

NRS5010	180±3.0 (7.087±0.118)	60±2.0 (2.36±0.08)	14.0±1.5 (0.551±0.059)
NRS5012			
NRS5014			
NRS5020			
NRS5030			
NRS6010			
NR 6012			
NRS6012			
NRS6014			

Unit: mm (inch)



Type	Reel size (Reference values)			
	φD	φd	t (max.)	W
NR 4010	330±3.0 (12.99±0.118)	80±2.0 (3.15±0.078)	18.5 (0.72)	13.5±1.0 (0.531±0.04)
NRS4010				
NR 4012				
NRS4012				
NR 4018				
NRS4018				
NRS5024				
NR 5040				
NRS5040				
NR 6020				
NRS6020				
NR 6028				
NRS6028				
NR 6045				
NRM6045				
NRS6045				
NRS8030	22.5 (0.89)	17.5±1.0 (0.689±0.04)		
NR 8040				
NRS8040				

Unit: mm (inch)

⑥ Top Tape Strength

The top tape requires a peel-off force of 0.1 to 1.3N in the direction of the arrow as illustrated below.



► This catalog contains the typical specification only due to the limitation of space. When you consider the purchase of our products, please check our specification. For details of each product (characteristics graph, reliability information, precautions for use, and so on), see our Web site (<http://www.ty-top.com/>).

SMD POWER INDUCTORS (NR□, NS SERIES)

RELIABILITY DATA

1. Operating Temperature Range		
Specified Value	NR30/40/50/60/80, NRS20, NRV20/30, NRH24/30 Type	-25~+120°C
	NRS40/50/60/80 Type	-25~+125°C
	NR10050 Type	-25~+105°C
	NS101, NS125 Type	-40~+125°C
Test Methods and Remarks	Including self-generated heat	
2. Storage Temperature Range		
Specified Value	NR30/40/50/60/80, NRV20/30, NRH24/30, NRS20/40/50/60/80 Type	-40~+85°C
	NR10050 Type	
	NS101, NS125 Type	
Test Methods and Remarks	NR30/40/50/60/80, NRV20/30, NRH24/30, NRS20/40/50/60/80 Type, NR10050 Type, NS101/125 Type : -5 to 40°C for the product with taping.	
3. Rated current		
Specified Value	NR30/40/50/60/80, NRV20/30, NRH24/30, NRS20/40/50/60/80 Type	Within the specified tolerance
	NR10050 Type	
	NS101, NS125 Type	
4. Inductance		
Specified Value	NR30/40/50/60/80, NRV20/30, NRH24/30, NRS20/40/50/60/80 Type	Within the specified tolerance
	NR10050 Type	
	NS101, NS125 Type	
Test Methods and Remarks	Measuring equipment : LCR Meter (HP 4285A or equivalent) Measuring frequency : Specified frequency NR30/40/50/60/80, NRV20/30, NRH24/30, NRS20/40/50/60/80 Type, NR10050 Type, NS101/125 Type : Measuring equipment : LCR Meter (HP 4285A or equivalent) Measuring frequency : 100kHz, 1V NR10050 Type : Measuring equipment : LCR Meter (HP 4263A or equivalent) Measuring frequency : 100kHz, 1V	
5. DC Resistance		
Specified Value	NR30/40/50/60/80, NRV20/30, NRH24/30, NRS20/40/50/60/80 Type	Within the specified tolerance
	NR10050 Type	
	NS101, NS125 Type	
Test Methods and Remarks	Measuring equipment : DC ohmmeter (HIOKI 3227 or equivalent)	
6. Self resonance frequency		
Specified Value	NR30/40/50/60/80, NRV30, NRH24/30, NRS40/50/60/80 Type	Within the specified tolerance
	NR10050 Type	
	NS101, NS125 Type	-
Test Methods and Remarks	NR30/40/50/60/80, NRV30, NRH24/30, NRS40/50/60/80 Type, NR10050 Type : Measuring equipment : Impedance analyzer/material analyzer (HP4291A or equivalent HP4191A, 4192A or equivalent)	

▶ This catalog contains the typical specification only due to the limitation of space. When you consider the purchase of our products, please check our specification.
 For details of each product (characteristics graph, reliability information, precautions for use, and so on), see our Web site (<http://www.ty-top.com/>).

7. Temperature characteristic														
Specified Value	NR30/40/50/60/80, NRV20/30, NRH24/30, NRS20/40/50/60/80 Type	Inductance change : Within $\pm 20\%$												
	NR10050 Type													
	NS101, NS125 Type	Inductance change : Within $\pm 15\%$												
Test Methods and Remarks	NR30/40/50/60/80, NRV20/30, NRH24/30, NRS20/40/50/60/80 Type, NR10050 Type : Measurement of inductance shall be taken at temperature range within $-25^{\circ}\text{C}\sim +85^{\circ}\text{C}$. With reference to inductance value at $+20^{\circ}\text{C}$., change rate shall be calculated.													
	NS101, NS125 Type : Measurement of inductance shall be taken at temperature range within $-40^{\circ}\text{C}\sim +125^{\circ}\text{C}$. With reference to inductance value at $+20^{\circ}\text{C}$., change rate shall be calculated. Change of maximum inductance deviation in step 1 to 5													
	<table border="1"> <thead> <tr> <th>Step</th> <th>Temperature ($^{\circ}\text{C}$)</th> </tr> </thead> <tbody> <tr> <td>1</td> <td>20</td> </tr> <tr> <td>2</td> <td>Minimum operating temperature</td> </tr> <tr> <td>3</td> <td>20 (Standard temperature)</td> </tr> <tr> <td>4</td> <td>Maximum operating temperature</td> </tr> <tr> <td>5</td> <td>20</td> </tr> </tbody> </table>	Step	Temperature ($^{\circ}\text{C}$)	1	20	2	Minimum operating temperature	3	20 (Standard temperature)	4	Maximum operating temperature	5	20	
Step	Temperature ($^{\circ}\text{C}$)													
1	20													
2	Minimum operating temperature													
3	20 (Standard temperature)													
4	Maximum operating temperature													
5	20													

8. Resistance to flexure of substrate																																												
Specified Value	NR30/40/50/60/80, NRV20/30, NRH24/30, NRS20/40/50/60/80 Type	No damage																																										
	NR10050 Type	—																																										
	NS101, NS125 Type	No damage																																										
Test Methods and Remarks	NR30/40/50/60/80, NRV20/30, NRH24/30, NRS20/40/50/60/80 Type, NS101/125 Type : The test samples shall be soldered to the test board by the reflow. As illustrated below, apply force in the direction of the arrow indicating until deflection of the test board reaches to 2 mm. Test board size : $100 \times 40 \times 1.0$ Test board material : Glass epoxy-resin Solder cream thickness : 0.10mm (NR30, NRS20, NRH24/30, NRV20/30) : 0.15mm (NR40/50/60/80, NRS40/50/60, NS101/125Type)																																											
	<div style="display: flex; align-items: flex-start;"> <div style="margin-right: 20px;"> <p>Land dimension</p>  </div> <table border="1"> <thead> <tr> <th>Type</th> <th>A</th> <th>B</th> <th>C</th> </tr> </thead> <tbody> <tr> <td>NRS20, NRV20</td> <td>0.65</td> <td>0.7</td> <td>2.0</td> </tr> <tr> <td>NRH24</td> <td>0.7</td> <td>0.75</td> <td>2.0</td> </tr> <tr> <td>NR30, NRV30, NRH30</td> <td>0.8</td> <td>1.4</td> <td>2.7</td> </tr> <tr> <td>NR40, NRS40</td> <td>1.2</td> <td>1.6</td> <td>3.7</td> </tr> <tr> <td>NR50, NRS50</td> <td>1.5</td> <td>2.1</td> <td>4.0</td> </tr> <tr> <td>NR60, NRS60</td> <td>1.6</td> <td>3.1</td> <td>5.7</td> </tr> <tr> <td>NR80, NRS80</td> <td>1.8</td> <td>3.8</td> <td>7.5</td> </tr> </tbody> </table> </div> <div style="margin-left: 20px;">  <table border="1"> <thead> <tr> <th>Type</th> <th>A</th> <th>B</th> <th>C</th> </tr> </thead> <tbody> <tr> <td>NS101</td> <td>2.5</td> <td>5.6</td> <td>3.2</td> </tr> <tr> <td>NS125</td> <td>2.5</td> <td>8.6</td> <td>3.2</td> </tr> </tbody> </table> </div>	Type	A	B	C	NRS20, NRV20	0.65	0.7	2.0	NRH24	0.7	0.75	2.0	NR30, NRV30, NRH30	0.8	1.4	2.7	NR40, NRS40	1.2	1.6	3.7	NR50, NRS50	1.5	2.1	4.0	NR60, NRS60	1.6	3.1	5.7	NR80, NRS80	1.8	3.8	7.5	Type	A	B	C	NS101	2.5	5.6	3.2	NS125	2.5	8.6
Type	A	B	C																																									
NRS20, NRV20	0.65	0.7	2.0																																									
NRH24	0.7	0.75	2.0																																									
NR30, NRV30, NRH30	0.8	1.4	2.7																																									
NR40, NRS40	1.2	1.6	3.7																																									
NR50, NRS50	1.5	2.1	4.0																																									
NR60, NRS60	1.6	3.1	5.7																																									
NR80, NRS80	1.8	3.8	7.5																																									
Type	A	B	C																																									
NS101	2.5	5.6	3.2																																									
NS125	2.5	8.6	3.2																																									

9. Insulation resistance : between wires		
Specified Value	NR30/40/50/60/80, NRV20/30, NRH24/30, NRS20/40/50/60/80 Type	—
	NR10050 Type	
	NS101, NS125 Type	

10. Insulation resistance : between wire and core		
Specified Value	NR30/40/50/60/80, NRV20/30, NRH24/30, NRS20/40/50/60/80 Type	—
	NR10050 Type	
	NS101, NS125 Type	

▶ This catalog contains the typical specification only due to the limitation of space. When you consider the purchase of our products, please check our specification.
For details of each product (characteristics graph, reliability information, precautions for use, and so on), see our Web site (<http://www.ty-top.com/>).

11. Withstanding voltage : between wire and core

Specified Value	NR30/40/50/60/80, NRV20/30, NRH24/30, NRS20/40/50/60/80 Type	-
	NR10050 Type	
	NS101, NS125 Type	

12. Adhesion of terminal electrode

Specified Value	NR30/40/50/60/80, NRV20/30, NRH24/30, NRS20/40/50/60/80 Type	Shall not come off PC board
	NR10050 Type	
	NS101, NS125 Type	
Test Methods and Remarks	<p>NR30/40/50/60/80, NRV20/30, NRH24/30, NRS20/40/50/60/80 Type, NS101/125 Type :</p> <p>The test samples shall be soldered to the test board by the reflow.</p> <p>Applied force : 10N to X and Y directions. Duration : 5s. Solder cream thickness : 0.10mm (NR30, NRS20, NRH24/30, NRV20/30) : 0.15mm (NR40/50/60/80, NRS40/50/60, NS101/125Type)</p>  <p>NR10050 Type Applied force : 5N to X and Y directions. Duration : 5s.</p>	

13. Resistance to vibration

Specified Value	NR30/40/50/60/80, NRV20/30, NRH24/30, NRS20/40/50/60/80 Type	Inductance change : Within $\pm 10\%$ No significant abnormality in appearance.														
	NR10050 Type															
	NS101, NS125 Type															
Test Methods and Remarks	<p>NR30/40/50/60/80, NRV20/30, NRH24/30, NRS20/40/50/60/80 Type, NR10050 Type, NS101/125 Type :</p> <p>The test samples shall be soldered to the test board by the reflow. Then it shall be submitted to below test conditions.</p> <table border="1" data-bbox="295 1164 1133 1344"> <tr> <td>Frequency Range</td> <td colspan="2">10~55Hz</td> </tr> <tr> <td>Total Amplitude</td> <td colspan="2">1.5mm (May not exceed acceleration 196m/s²)</td> </tr> <tr> <td>Sweeping Method</td> <td colspan="2">10Hz to 55Hz to 10Hz for 1min.</td> </tr> <tr> <td rowspan="3">Time</td> <td>X</td> <td rowspan="3">For 2 hours on each X, Y, and Z axis.</td> </tr> <tr> <td>Y</td> </tr> <tr> <td>Z</td> </tr> </table> <p>Recovery : At least 2hrs of recovery under the standard condition after the test, followed by the measurement within 48hrs.</p>	Frequency Range	10~55Hz		Total Amplitude	1.5mm (May not exceed acceleration 196m/s ²)		Sweeping Method	10Hz to 55Hz to 10Hz for 1min.		Time	X	For 2 hours on each X, Y, and Z axis.	Y	Z	
Frequency Range	10~55Hz															
Total Amplitude	1.5mm (May not exceed acceleration 196m/s ²)															
Sweeping Method	10Hz to 55Hz to 10Hz for 1min.															
Time	X	For 2 hours on each X, Y, and Z axis.														
	Y															
	Z															

14. Solderability

Specified Value	NR30/40/50/60/80, NRV20/30, NRH24/30, NRS20/40/50/60/80 Type	At least 90% of surface of terminal electrode is covered by new solder.				
	NR10050 Type					
	NS101, NS125 Type					
Test Methods and Remarks	<p>The test samples shall be dipped in flux, and then immersed in molten solder as shown in below table.</p> <p>Flux : Methanol solution containing rosin 25%. NR30/40/50/60/80, NRV20/30, NRH24/30, NRS20/40/50/60/80 Type, NR10050 Type, NS101/125 Type</p> <table border="1" data-bbox="279 1691 702 1758"> <tr> <td>Solder Temperature</td> <td>245\pm5$^{\circ}$C</td> </tr> <tr> <td>Time</td> <td>5\pm1.0 sec.</td> </tr> </table> <p>※Immersion depth : All sides of mounting terminal shall be immersed.</p>	Solder Temperature	245 \pm 5 $^{\circ}$ C	Time	5 \pm 1.0 sec.	
Solder Temperature	245 \pm 5 $^{\circ}$ C					
Time	5 \pm 1.0 sec.					

▶ This catalog contains the typical specification only due to the limitation of space. When you consider the purchase of our products, please check our specification.
For details of each product (characteristics graph, reliability information, precautions for use, and so on), see our Web site (<http://www.ty-top.com/>).

15. Resistance to soldering heat		
Specified Value	NR30/40/50/60/80, NRV20/30, NRH24/30, NRS20/40/50/60/80 Type	Inductance change : Within $\pm 10\%$ No significant abnormality in appearance.
	NR10050 Type	
	NS101, NS125 Type	
Test Methods and Remarks	NR30/40/50/60/80, NRV20/30, NRH24/30, NRS20/40/50/60/80 Type, NR10050 Type, NS101/125 Type : The test sample shall be exposed to reflow oven at $230\pm 5^{\circ}\text{C}$ for 40 seconds, with peak temperature at $260\pm 5^{\circ}\text{C}$ for 5 seconds, 2 times. NR30/40/50/60/80, NRV20/30, NRH24/30, NRS20/40/50/60/80 Type, NS101/125 Type Test board material : Glass epoxy-resin Test board thickness : 1.0mm NR10050 Type Test board material : Glass epoxy-resin Test board thickness : 1.6mm Recovery : At least 2hrs of recovery under the standard condition after the test, followed by the measurement within 48hrs.	

16. Thermal shock																				
Specified Value	NR30/40/50/60/80, NRV20/30, NRH24/30, NRS20/40/50/60/80 Type	Inductance change : Within $\pm 10\%$ No significant abnormality in appearance.																		
	NR10050 Type																			
	NS101, NS125 Type																			
Test Methods and Remarks	NR30/40/50/60/80, NRV20/30, NRH24/30, NRS20/40/50/60/80 Type, NR10050 Type, NS101/125 Type : The test samples shall be soldered to the test board by the reflow. The test samples shall be placed at specified temperature for specified time by step 1 to step 4 as shown in below table in sequence. The temperature cycle shall be repeated 100 cycles. <table border="1" style="margin: 10px auto;"> <thead> <tr> <th colspan="3">Conditions of 1 cycle</th> </tr> <tr> <th>Step</th> <th>Temperature ($^{\circ}\text{C}$)</th> <th>Duration (min)</th> </tr> </thead> <tbody> <tr> <td>1</td> <td>-40 ± 3</td> <td>30 ± 3</td> </tr> <tr> <td>2</td> <td>Room temperature</td> <td>Within 3</td> </tr> <tr> <td>3</td> <td>$+85\pm 2$</td> <td>30 ± 3</td> </tr> <tr> <td>4</td> <td>Room temperature</td> <td>Within 3</td> </tr> </tbody> </table> Recovery : At least 2hrs of recovery under the standard condition after the test, followed by the measurement within 48hrs.		Conditions of 1 cycle			Step	Temperature ($^{\circ}\text{C}$)	Duration (min)	1	-40 ± 3	30 ± 3	2	Room temperature	Within 3	3	$+85\pm 2$	30 ± 3	4	Room temperature	Within 3
Conditions of 1 cycle																				
Step	Temperature ($^{\circ}\text{C}$)	Duration (min)																		
1	-40 ± 3	30 ± 3																		
2	Room temperature	Within 3																		
3	$+85\pm 2$	30 ± 3																		
4	Room temperature	Within 3																		

17. Damp heat								
Specified Value	NR30/40/50/60/80, NRV20/30, NRH24/30, NRS20/40/50/60/80 Type	Inductance change : Within $\pm 10\%$ No significant abnormality in appearance.						
	NR10050 Type		—					
	NS101, NS125 Type	Inductance change : Within $\pm 10\%$ No significant abnormality in appearance.						
Test Methods and Remarks	NR30/40/50/60/80, NRV20/30, NRH24/30, NRS20/40/50/60/80 Type, NS101/125 Type : The test samples shall be soldered to the test board by the reflow. The test samples shall be placed in thermostatic oven set at specified temperature and humidity as shown in below table. <table border="1" style="margin: 10px auto;"> <tbody> <tr> <td>Temperature</td> <td>$60\pm 2^{\circ}\text{C}$</td> </tr> <tr> <td>Humidity</td> <td>90~95%RH</td> </tr> <tr> <td>Time</td> <td>500+24/-0 hour</td> </tr> </tbody> </table> Recovery : At least 2hrs of recovery under the standard condition after the test, followed by the measurement within 48hrs.		Temperature	$60\pm 2^{\circ}\text{C}$	Humidity	90~95%RH	Time	500+24/-0 hour
Temperature	$60\pm 2^{\circ}\text{C}$							
Humidity	90~95%RH							
Time	500+24/-0 hour							

18. Loading under damp heat										
Specified Value	NR30/40/50/60/80, NRV20/30, NRH24/30, NRS20/40/50/60/80 Type	Inductance change : Within $\pm 10\%$ No significant abnormality in appearance.								
	NR10050 Type									
	NS101, NS125 Type									
Test Methods and Remarks	NR30/40/50/60/80, NRV20/30, NRH24/30, NRS20/40/50/60/80 Type, NR10050 Type, NS101/125 Type : The test samples shall be soldered to the test board by the reflow. The test samples shall be placed in thermostatic oven set at specified temperature and humidity and applied the rated current continuously as shown in below table. <table border="1" style="margin: 10px auto;"> <tbody> <tr> <td>Temperature</td> <td>$60\pm 2^{\circ}\text{C}$</td> </tr> <tr> <td>Humidity</td> <td>90~95%RH</td> </tr> <tr> <td>Applied current</td> <td>Rated current</td> </tr> <tr> <td>Time</td> <td>500+24/-0 hour</td> </tr> </tbody> </table> Recovery : At least 2hrs of recovery under the standard condition after the test, followed by the measurement within 48hrs.		Temperature	$60\pm 2^{\circ}\text{C}$	Humidity	90~95%RH	Applied current	Rated current	Time	500+24/-0 hour
Temperature	$60\pm 2^{\circ}\text{C}$									
Humidity	90~95%RH									
Applied current	Rated current									
Time	500+24/-0 hour									

▶ This catalog contains the typical specification only due to the limitation of space. When you consider the purchase of our products, please check our specification.
 For details of each product (characteristics graph, reliability information, precautions for use, and so on), see our Web site (<http://www.ty-top.com/>).

19. Low temperature life test		
Specified Value	NR30/40/50/60/80, NRV20/30, NRH24/30, NRS20/40/50/60/80 Type	Inductance change : Within $\pm 10\%$ No significant abnormality in appearance.
	NR10050 Type	
	NS101, NS125 Type	
Test Methods and Remarks	NR30/40/50/60/80, NRV20/30, NRH24/30, NRS20/40/50/60/80 Type, NR10050 Type, NS101/125 Type : The test samples shall be soldered to the test board by the reflow. After that, the test samples shall be placed at test conditions as shown in below table.	
	Temperature	$-40 \pm 2^{\circ}\text{C}$
	Time	$500 + 24 / - 0$ hour
Recovery : At least 2hrs of recovery under the standard condition after the test, followed by the measurement within 48hrs.		
20. High temperature life test		
Specified Value	NR30/40/50/60/80, NRV20/30, NRH24/30, NRS20/40/50/60/80 Type	—
	NR10050 Type	—
	NS101, NS125 Type	—
Test Methods and Remarks	NR10050 Type :	
	Temperature	$105 \pm 3^{\circ}\text{C}$
	Time	$500 + 24 / - 0$ hour
Recovery : At least 2hrs of recovery under the standard condition after the test, followed by the measurement within 48hrs.		
21. Loading at high temperature life test		
Specified Value	NR30/40/50/60/80, NRV20/30, NRH24/30, NRS20/40/50/60/80 Type	Inductance change : Within $\pm 10\%$ No significant abnormality in appearance.
	NR10050 Type	—
	NS101, NS125 Type	Inductance change : Within $\pm 10\%$ No significant abnormality in appearance.
Test Methods and Remarks	NR30/40/50/60/80, NRV30, NRH24/30, NRS40/50/60/80 Type, NS12555, NS12565, NS12575 Type : The test samples shall be soldered to the test board by the reflow soldering.	
	Temperature	$85 \pm 2^{\circ}\text{C}$
	Applied current	Rated current
	Time	$500 + 24 / - 0$ hour
Recovery : At least 2hrs of recovery under the standard condition after the test, followed by the measurement within 48hrs.		
22. Standard condition		
Specified Value	NR30/40/50/60/80, NRV20/30, NRH24/30, NRS20/40/50/60/80 Type	Standard test condition : Unless otherwise specified, temperature is $20 \pm 15^{\circ}\text{C}$ and $65 \pm 20\%$ of relative humidity. When there is any question concerning measurement result: In order to provide correlation data, the test shall be condition of $20 \pm 2^{\circ}\text{C}$ of temperature, $65 \pm 5\%$ relative humidity. Inductance is in accordance with our measured value.
	NR10050 Type	
	NS101, NS125 Type	

SMD POWER INDUCTORS (NR□, NS SERIES)

PRECAUTIONS

1. Circuit Design

Precautions

◆ Operating environment

1. The products described in this specification are intended for use in general electronic equipment, (office supply equipment, telecommunications systems, measuring equipment, and household equipment). They are not intended for use in mission-critical equipment or systems requiring special quality and high reliability (traffic systems, safety equipment, aerospace systems, nuclear control systems and medical equipment including life-support systems,) where product failure might result in loss of life, injury or damage. For such uses, contact TAIYO YUDEN Sales Department in advance.

2. PCB Design

Precautions

◆ Land pattern design

1. Please refer to a recommended land pattern.
2. There is stress, which has been caused by distortion of a PCB, to the inductor.
(NR30/40/50/60/80, NRV20/30, NRH24/30, NRS20/30/40/50/60/80 Type)
3. Please consider the arrangement of parts on a PCB. (NR30/40/50/60/80, NRV20/30, NRH24/30, NRS20/30/40/50/60/80 Type)

Technical considerations

◆ Land pattern design

Surface Mounting

1. Mounting and soldering conditions should be checked beforehand.
2. Applicable soldering process to this products is reflow soldering only.
3. Please use the recommended land pattern shown as below. Electrical characteristics and the mounting ability of the product are being considered in the recommended land pattern. If a PCB is designed with other dimensions, defective soldering and stress to a product may occur due to misalignment. The performance of the product may not be brought out. If an adopted land pattern is different from the recommended land pattern, stress to the product will increase. It may cause cracks or defective electrical characteristics of the product. Please conduct validation completely before studying adoption of this product and please judge the pros and cons of adoption of this product with taking on responsibility.
(NR30/40/50/60/80, NRV20/30, NRH24/30, NRS20/30/40/50/60/80 Type)
4. As coefficients of thermal expansion between an inductor and a PCB differs, cracks may occur on a ferrite core when thermal stress is applied to them after mounting an inductor. (Please refer to the drawings below.) Please conduct validation completely before studying adoption of this product and please judge the pros and cons of adoption of this product with taking on responsibility.
(NR30/40/50/60/80, NRV20/30, NRH24/30, NRS20/30/40/50/60/80 Type)



5. SMD inductors should be located to minimize any possible mechanical stresses from board warp or deflection. When splitting the PCB board after mounting inductors and other components, care is required so as not to give any stresses of deflection or twisting to the board.
(NR30/40/50/60/80, NRV20/30, NRH24/30, NRS20/30/40/50/60/80 Type)



A product tends to undergo stress in order "A>C>B≡D".
Please consider the layouts of a product to minimize any stresses.

3. Considerations for automatic placement	
Precautions	<ul style="list-style-type: none"> ◆Adjustment of mounting machine <ol style="list-style-type: none"> 1. Excessive impact load should not be imposed on the products when mounting onto the PC boards. 2. Mounting and soldering conditions should be checked beforehand.
Technical considerations	<ul style="list-style-type: none"> ◆Adjustment of mounting machine <ol style="list-style-type: none"> 1. When installing products, care should be taken not to apply distortion stress as it may deform the products. 2. Stress may be applied to a product with a warp or a twist in handling of the product. Please conduct validation completely before studying adoption of this product and please judge the pros and cons of adoption of this product with taking on responsibility. (NR30/40/50/60/80, NRV20/30, NRH24/30, NRS20/30/40/50/60/80 Type) <div style="display: flex; justify-content: space-around; align-items: center;"> <div style="text-align: center;"> <p><Wrap></p>  </div> <div style="text-align: center;"> <p><Twist></p>  </div> </div>

4. Soldering	
Precautions	<ul style="list-style-type: none"> ◆Reflow soldering <ol style="list-style-type: none"> 1. Please contact any of our offices for a reflow soldering, and refer to the recommended condition specified. 2. The product shall be used reflow soldering only. 3. Please do not add any stress to a product until it returns in normal temperature after reflow soldering. ◆Lead free soldering <ol style="list-style-type: none"> 1. When using products with lead free soldering, we request to use them after confirming adhesion, temperature of resistance to soldering heat, soldering etc sufficiently. ◆Recommended conditions for using a soldering iron (NR10050 Type) <ul style="list-style-type: none"> • Put the soldering iron on the land-pattern. • Soldering iron's temperature – Below 350°C • Duration – 3 seconds or less • The soldering iron should not directly touch the inductor.
Technical considerations	<ul style="list-style-type: none"> ◆Reflow soldering <ol style="list-style-type: none"> 1. If products are used beyond the range of the recommended conditions, heat stresses may deform the products, and consequently degrade the reliability of the products. <ul style="list-style-type: none"> • NR30/40/50/60/80, NRV20/30, NRH24/30, NRS20/40/50/60/80 Type, NR10050 Type, NS101/125 Type <p>Recommended reflow condition (Pb free solder)</p> 

5. Cleaning	
Precautions	<ul style="list-style-type: none"> ◆Cleaning conditions <ol style="list-style-type: none"> 1. Washing by supersonic waves shall be avoided.
Technical considerations	<ul style="list-style-type: none"> ◆Cleaning conditions <ol style="list-style-type: none"> 1. If washed by supersonic waves, the products might be broken.

▶ This catalog contains the typical specification only due to the limitation of space. When you consider the purchase of our products, please check our specification. For details of each product (characteristics graph, reliability information, precautions for use, and so on), see our Web site (<http://www.ty-top.com/>)

6. Handling	
Precautions	<ul style="list-style-type: none"> ◆ Handling <ol style="list-style-type: none"> 1. Keep the product away from all magnets and magnetic objects. ◆ Breakaway PC boards (splitting along perforations) <ol style="list-style-type: none"> 1. When splitting the PC board after mounting product, care should be taken not to give any stresses of deflection or twisting to the board. 2. Board separation should not be done manually, but by using the appropriate devices. ◆ Mechanical considerations <ol style="list-style-type: none"> 1. Please do not give the product any excessive mechanical shocks. 2. Please do not add any shock and power to a product in transportation. ◆ Pick-up pressure <ol style="list-style-type: none"> 1. Please do not push to add any pressure to a winding part. Please do not give any shock and push into a ferrite core exposure part. ◆ Packing <ol style="list-style-type: none"> 1. Please avoid accumulation of a packing box as much as possible.
Technical considerations	<ul style="list-style-type: none"> ◆ Handling <ol style="list-style-type: none"> 1. There is a case that a characteristic varies with magnetic influence. ◆ Breakaway PC boards (splitting along perforations) <ol style="list-style-type: none"> 1. The position of the product on PCBs shall be carefully considered to minimize the stress caused from splitting of the PCBs. ◆ Mechanical considerations <ol style="list-style-type: none"> 1. There is a case to be damaged by a mechanical shock. 2. There is a case to be broken by the handling in transportation. ◆ Pick-up pressure <ol style="list-style-type: none"> 1. Damage and a characteristic can vary with an excessive shock or stress. ◆ Packing <ol style="list-style-type: none"> 1. If packing boxes are accumulated, that could cause a deformation on packing tapes or a damage on the products.
7. Storage conditions	
Precautions	<ul style="list-style-type: none"> ◆ Storage <ol style="list-style-type: none"> 1. To maintain the solderability of terminal electrodes and to keep the packing material in good condition, temperature and humidity in the storage area should be controlled. <ul style="list-style-type: none"> ▪ Recommended conditions <ul style="list-style-type: none"> Ambient temperature : $-5\sim 40^{\circ}\text{C}$ Humidity : Below 70% RH ▪ The ambient temperature must be kept below 30°C. Even under ideal storage conditions, solderability of products electrodes may decrease as time passes. <ul style="list-style-type: none"> For this reason, product should be used within 6 months from the time of delivery. In case of storage over 6 months, solderability shall be checked before actual usage.
Technical considerations	<ul style="list-style-type: none"> ◆ Storage <ol style="list-style-type: none"> 1. Under a high temperature and humidity environment, problems such as reduced solderability caused by oxidation of terminal electrodes and deterioration of taping/packaging materials may take place.

SMD POWER INDUCTORS



REFLOW

■ PARTS NUMBER

*Operating Temp.: -25~+105°C (Including self-generated heat)

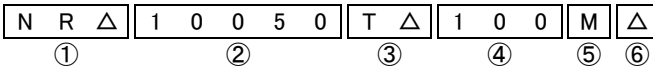

△ = Blank space

① Series name

Code	Series name
NR△	Coating resin specification

② Dimensions (L × H)

Code	Dimensions (L × H) [mm]
10050	10.0 × 5.0

③ Packaging

Code	Packaging
T△	Taping

④ Nominal inductance

Code (example)	Nominal inductance [μH]
1R3	1.3
100	10
101	100

※R=Decimal point

⑤ Inductance tolerance

Code	Inductance tolerance
M	±20%
N	±30%

⑥ Internal code

Code	Internal code
△	standard

■ STANDARD EXTERNAL DIMENSIONS / STANDARD QUANTITY

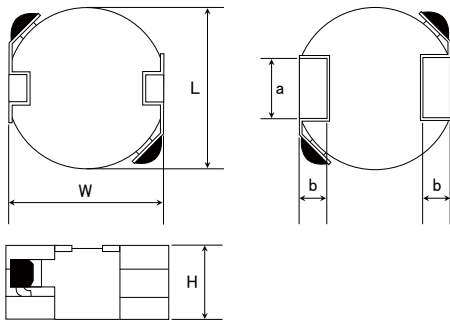

Recommended Land Patterns
Surface Mounting

- Mounting and soldering conditions should be checked beforehand.
- Applicable soldering process to these products is reflow soldering only.

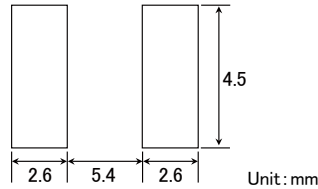

Type	L	W	H	a	b	Standard quantity [pcs] Taping
NR 10050	10.0±0.3 (0.394±0.012)	9.8±0.5 (0.386±0.020)	5.0 max (0.197 max)	4.0 (0.16)	1.75 (0.07)	500

Unit: mm (inch)

■ PARTS NUMBER

● NR 10050 type

Parts number	EHS	Nominal inductance [μH]	Inductance tolerance	Self-resonant frequency [MHz] (min.)	DC Resistance [Ω] (±30%)	Rated current ※) [mA]		Measuring frequency [kHz]
						Saturation current Idc1	Temperature rise current Idc2	
NR 10050T 1R3N	RoHS	1.3	±30%	53	0.0068	11,000	9,000	100
NR 10050T 2R1N	RoHS	2.1	±30%	37	0.0080	10,000	8,300	100
NR 10050T 2R9N	RoHS	2.9	±30%	29	0.0093	8,200	7,300	100
NR 10050T 3R8N	RoHS	3.8	±30%	26	0.013	7,300	6,800	100
NR 10050T 4R9N	RoHS	4.9	±30%	23	0.015	6,600	6,000	100
NR 10050T 6R5N	RoHS	6.5	±30%	19	0.018	6,000	5,200	100
NR 10050T 100M	RoHS	10	±20%	15	0.025	4,700	4,100	100
NR 10050T 150M	RoHS	15	±20%	11	0.035	3,600	3,200	100
NR 10050T 220M	RoHS	22	±20%	10	0.045	2,600	2,500	100
NR 10050T 330M	RoHS	33	±20%	8.2	0.066	2,500	2,100	100
NR 10050T 470M	RoHS	47	±20%	7.0	0.092	2,000	1,800	100
NR 10050T 680M	RoHS	68	±20%	5.6	0.144	1,700	1,500	100
NR 10050T 101M	RoHS	100	±20%	4.6	0.209	1,300	1,200	100
NR 10050T 221M	RoHS	220	±20%	3.0	0.450	1,000	800	100

※) The saturation current value (Idc1) is the DC current value having inductance decrease down to 30%. (at 20°C)

※) The temperature rise current value (Idc2) is the DC current value having temperature increase up to 40°C. (at 20°C)

※) The maximum rated current is the DC current value that satisfies both of current value Saturation current value and temperature rise current value. (at 20°C)

▶ This catalog contains the typical specification only due to the limitation of space. When you consider the purchase of our products, please check our product specification sheets. For details of each product (characteristics graph, reliability information, precautions for use, and so on), see our website (<http://www.ty-top.com/>).

SMD POWER INDUCTORS

PACKAGING

① Minimum Quantity

Type	Standard Quantity [pcs]
	Tape & Reel
NR 10050	500

② Tape Material

● Embossed Tape

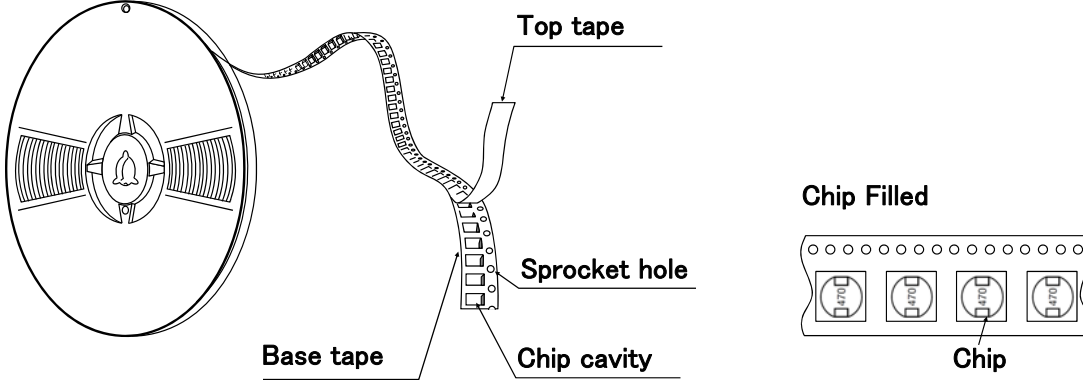

③ Taping dimensions

● Embossed tape 24mm wide (0.945 inches wide)

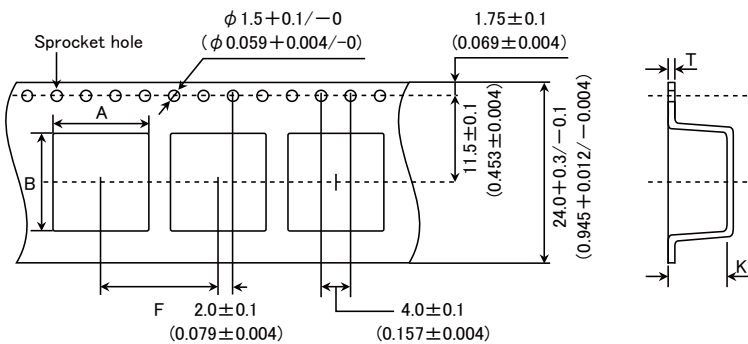

Type	Chip cavity		Insertion pitch	Tape thickness	
	A	B	F	T	K
NR 10050	10.4 ± 0.1 (0.409 ± 0.004)	9.9 ± 0.1 (0.390 ± 0.004)	16.0 ± 0.1 (0.630 ± 0.004)	0.5 ± 0.05 (0.020 ± 0.002)	5.7 ± 0.1 (0.224 ± 0.004)

Unit : mm (inch)

④ Leader and Blank portion

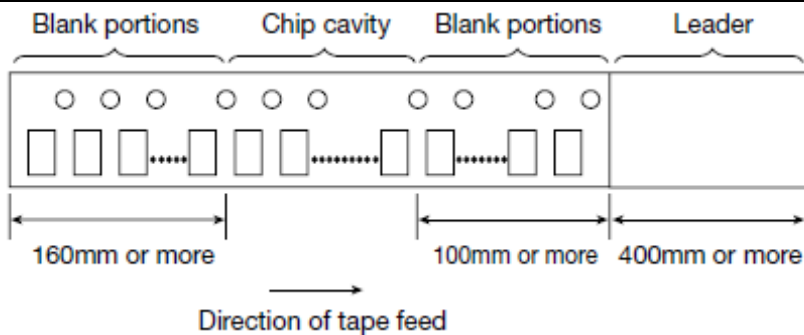

► This catalog contains the typical specification only due to the limitation of space. When you consider the purchase of our products, please check our specification. For details of each product (characteristics graph, reliability information, precautions for use, and so on), see our Web site (<http://www.ty-top.com/>).

⑤ Reel size

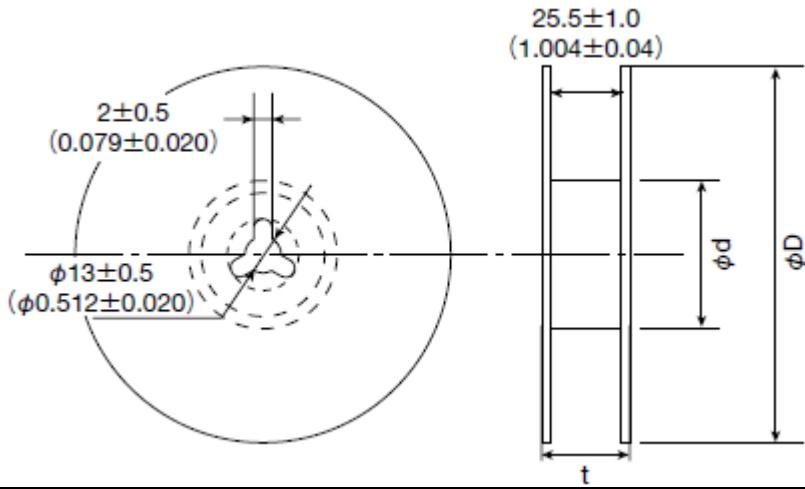

Type	Reel size (Reference value)		
	ϕD	ϕd	t (max.)
NR 10050	330±3 (12.99±0.118)	80±2 (3.15±0.078)	30.5 (1.201)

Unit : mm (inch)

⑥ Top Tape Strength

The top tape requires a peel-off force of 0.1 to 1.3N in the direction of the arrow as illustrated below.

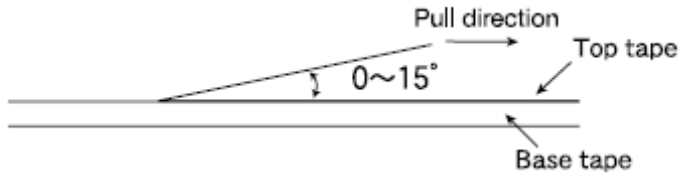

SMD POWER INDUCTORS (NR□, NS SERIES)

RELIABILITY DATA

1. Operating Temperature Range		
Specified Value	NR30/40/50/60/80, NRS20, NRV20/30, NRH24/30 Type	-25~+120°C
	NRS40/50/60/80 Type	-25~+125°C
	NR10050 Type	-25~+105°C
	NS101, NS125 Type	-40~+125°C
Test Methods and Remarks	Including self-generated heat	
2. Storage Temperature Range		
Specified Value	NR30/40/50/60/80, NRV20/30, NRH24/30, NRS20/40/50/60/80 Type	-40~+85°C
	NR10050 Type	
	NS101, NS125 Type	
Test Methods and Remarks	NR30/40/50/60/80, NRV20/30, NRH24/30, NRS20/40/50/60/80 Type, NR10050 Type, NS101/125 Type : -5 to 40°C for the product with taping.	
3. Rated current		
Specified Value	NR30/40/50/60/80, NRV20/30, NRH24/30, NRS20/40/50/60/80 Type	Within the specified tolerance
	NR10050 Type	
	NS101, NS125 Type	
4. Inductance		
Specified Value	NR30/40/50/60/80, NRV20/30, NRH24/30, NRS20/40/50/60/80 Type	Within the specified tolerance
	NR10050 Type	
	NS101, NS125 Type	
Test Methods and Remarks	Measuring equipment : LCR Meter (HP 4285A or equivalent) Measuring frequency : Specified frequency NR30/40/50/60/80, NRV20/30, NRH24/30, NRS20/40/50/60/80 Type, NR10050 Type, NS101/125 Type : Measuring equipment : LCR Meter (HP 4285A or equivalent) Measuring frequency : 100kHz, 1V NR10050 Type : Measuring equipment : LCR Meter (HP 4263A or equivalent) Measuring frequency : 100kHz, 1V	
5. DC Resistance		
Specified Value	NR30/40/50/60/80, NRV20/30, NRH24/30, NRS20/40/50/60/80 Type	Within the specified tolerance
	NR10050 Type	
	NS101, NS125 Type	
Test Methods and Remarks	Measuring equipment : DC ohmmeter (HIOKI 3227 or equivalent)	
6. Self resonance frequency		
Specified Value	NR30/40/50/60/80, NRV30, NRH24/30, NRS40/50/60/80 Type	Within the specified tolerance
	NR10050 Type	
	NS101, NS125 Type	-
Test Methods and Remarks	NR30/40/50/60/80, NRV30, NRH24/30, NRS40/50/60/80 Type, NR10050 Type : Measuring equipment : Impedance analyzer/material analyzer (HP4291A or equivalent HP4191A, 4192A or equivalent)	

▶ This catalog contains the typical specification only due to the limitation of space. When you consider the purchase of our products, please check our specification.
 For details of each product (characteristics graph, reliability information, precautions for use, and so on), see our Web site (<http://www.ty-top.com/>).

7. Temperature characteristic														
Specified Value	NR30/40/50/60/80, NRV20/30, NRH24/30, NRS20/40/50/60/80 Type	Inductance change : Within $\pm 20\%$												
	NR10050 Type													
	NS101, NS125 Type	Inductance change : Within $\pm 15\%$												
Test Methods and Remarks	NR30/40/50/60/80, NRV20/30, NRH24/30, NRS20/40/50/60/80 Type, NR10050 Type : Measurement of inductance shall be taken at temperature range within $-25^{\circ}\text{C}\sim +85^{\circ}\text{C}$. With reference to inductance value at $+20^{\circ}\text{C}$., change rate shall be calculated.													
	NS101, NS125 Type : Measurement of inductance shall be taken at temperature range within $-40^{\circ}\text{C}\sim +125^{\circ}\text{C}$. With reference to inductance value at $+20^{\circ}\text{C}$., change rate shall be calculated. Change of maximum inductance deviation in step 1 to 5													
	<table border="1"> <thead> <tr> <th>Step</th> <th>Temperature ($^{\circ}\text{C}$)</th> </tr> </thead> <tbody> <tr> <td>1</td> <td>20</td> </tr> <tr> <td>2</td> <td>Minimum operating temperature</td> </tr> <tr> <td>3</td> <td>20 (Standard temperature)</td> </tr> <tr> <td>4</td> <td>Maximum operating temperature</td> </tr> <tr> <td>5</td> <td>20</td> </tr> </tbody> </table>	Step	Temperature ($^{\circ}\text{C}$)	1	20	2	Minimum operating temperature	3	20 (Standard temperature)	4	Maximum operating temperature	5	20	
Step	Temperature ($^{\circ}\text{C}$)													
1	20													
2	Minimum operating temperature													
3	20 (Standard temperature)													
4	Maximum operating temperature													
5	20													

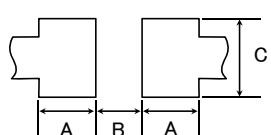
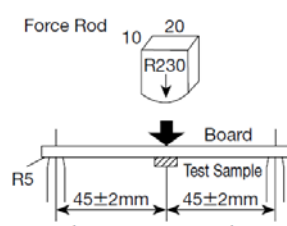
8. Resistance to flexure of substrate																																												
Specified Value	NR30/40/50/60/80, NRV20/30, NRH24/30, NRS20/40/50/60/80 Type	No damage																																										
	NR10050 Type	—																																										
	NS101, NS125 Type	No damage																																										
Test Methods and Remarks	NR30/40/50/60/80, NRV20/30, NRH24/30, NRS20/40/50/60/80 Type, NS101/125 Type : The test samples shall be soldered to the test board by the reflow. As illustrated below, apply force in the direction of the arrow indicating until deflection of the test board reaches to 2 mm. Test board size : $100 \times 40 \times 1.0$ Test board material : Glass epoxy-resin Solder cream thickness : 0.10mm (NR30, NRS20, NRH24/30, NRV20/30) : 0.15mm (NR40/50/60/80, NRS40/50/60, NS101/125Type)																																											
	<div style="display: flex; align-items: flex-start;"> <div style="margin-right: 20px;"> <p>Land dimension</p>  </div> <table border="1"> <thead> <tr> <th>Type</th> <th>A</th> <th>B</th> <th>C</th> </tr> </thead> <tbody> <tr> <td>NRS20, NRV20</td> <td>0.65</td> <td>0.7</td> <td>2.0</td> </tr> <tr> <td>NRH24</td> <td>0.7</td> <td>0.75</td> <td>2.0</td> </tr> <tr> <td>NR30, NRV30, NRH30</td> <td>0.8</td> <td>1.4</td> <td>2.7</td> </tr> <tr> <td>NR40, NRS40</td> <td>1.2</td> <td>1.6</td> <td>3.7</td> </tr> <tr> <td>NR50, NRS50</td> <td>1.5</td> <td>2.1</td> <td>4.0</td> </tr> <tr> <td>NR60, NRS60</td> <td>1.6</td> <td>3.1</td> <td>5.7</td> </tr> <tr> <td>NR80, NRS80</td> <td>1.8</td> <td>3.8</td> <td>7.5</td> </tr> </tbody> </table> </div> <div style="margin-left: 20px;">  <table border="1"> <thead> <tr> <th>Type</th> <th>A</th> <th>B</th> <th>C</th> </tr> </thead> <tbody> <tr> <td>NS101</td> <td>2.5</td> <td>5.6</td> <td>3.2</td> </tr> <tr> <td>NS125</td> <td>2.5</td> <td>8.6</td> <td>3.2</td> </tr> </tbody> </table> </div>	Type	A	B	C	NRS20, NRV20	0.65	0.7	2.0	NRH24	0.7	0.75	2.0	NR30, NRV30, NRH30	0.8	1.4	2.7	NR40, NRS40	1.2	1.6	3.7	NR50, NRS50	1.5	2.1	4.0	NR60, NRS60	1.6	3.1	5.7	NR80, NRS80	1.8	3.8	7.5	Type	A	B	C	NS101	2.5	5.6	3.2	NS125	2.5	8.6
Type	A	B	C																																									
NRS20, NRV20	0.65	0.7	2.0																																									
NRH24	0.7	0.75	2.0																																									
NR30, NRV30, NRH30	0.8	1.4	2.7																																									
NR40, NRS40	1.2	1.6	3.7																																									
NR50, NRS50	1.5	2.1	4.0																																									
NR60, NRS60	1.6	3.1	5.7																																									
NR80, NRS80	1.8	3.8	7.5																																									
Type	A	B	C																																									
NS101	2.5	5.6	3.2																																									
NS125	2.5	8.6	3.2																																									

9. Insulation resistance : between wires		
Specified Value	NR30/40/50/60/80, NRV20/30, NRH24/30, NRS20/40/50/60/80 Type	—
	NR10050 Type	
	NS101, NS125 Type	

10. Insulation resistance : between wire and core		
Specified Value	NR30/40/50/60/80, NRV20/30, NRH24/30, NRS20/40/50/60/80 Type	—
	NR10050 Type	
	NS101, NS125 Type	

▶ This catalog contains the typical specification only due to the limitation of space. When you consider the purchase of our products, please check our specification.
For details of each product (characteristics graph, reliability information, precautions for use, and so on), see our Web site (<http://www.ty-top.com/>).

11. Withstanding voltage : between wire and core		
Specified Value	NR30/40/50/60/80, NRV20/30, NRH24/30, NRS20/40/50/60/80 Type	-
	NR10050 Type	
	NS101, NS125 Type	

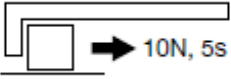
12. Adhesion of terminal electrode		
Specified Value	NR30/40/50/60/80, NRV20/30, NRH24/30, NRS20/40/50/60/80 Type	Shall not come off PC board
	NR10050 Type	
	NS101, NS125 Type	
Test Methods and Remarks	NR30/40/50/60/80, NRV20/30, NRH24/30, NRS20/40/50/60/80 Type, NS101/125 Type : The test samples shall be soldered to the test board by the reflow. Applied force : 10N to X and Y directions. Duration : 5s. Solder cream thickness : 0.10mm (NR30, NRS20, NRH24/30, NRV20/30) : 0.15mm (NR40/50/60/80, NRS40/50/60, NS101/125Type)	
	 NR10050 Type Applied force : 5N to X and Y directions. Duration : 5s.	

13. Resistance to vibration																
Specified Value	NR30/40/50/60/80, NRV20/30, NRH24/30, NRS20/40/50/60/80 Type	Inductance change : Within $\pm 10\%$ No significant abnormality in appearance.														
	NR10050 Type															
	NS101, NS125 Type															
Test Methods and Remarks	NR30/40/50/60/80, NRV20/30, NRH24/30, NRS20/40/50/60/80 Type, NR10050 Type, NS101/125 Type : The test samples shall be soldered to the test board by the reflow. Then it shall be submitted to below test conditions. <table border="1" data-bbox="295 1164 1133 1344"> <tr> <td>Frequency Range</td> <td colspan="2">10~55Hz</td> </tr> <tr> <td>Total Amplitude</td> <td colspan="2">1.5mm (May not exceed acceleration 196m/s²)</td> </tr> <tr> <td>Sweeping Method</td> <td colspan="2">10Hz to 55Hz to 10Hz for 1min.</td> </tr> <tr> <td rowspan="3">Time</td> <td>X</td> <td rowspan="3">For 2 hours on each X, Y, and Z axis.</td> </tr> <tr> <td>Y</td> </tr> <tr> <td>Z</td> </tr> </table> Recovery : At least 2hrs of recovery under the standard condition after the test, followed by the measurement within 48hrs.		Frequency Range	10~55Hz		Total Amplitude	1.5mm (May not exceed acceleration 196m/s ²)		Sweeping Method	10Hz to 55Hz to 10Hz for 1min.		Time	X	For 2 hours on each X, Y, and Z axis.	Y	Z
Frequency Range	10~55Hz															
Total Amplitude	1.5mm (May not exceed acceleration 196m/s ²)															
Sweeping Method	10Hz to 55Hz to 10Hz for 1min.															
Time	X	For 2 hours on each X, Y, and Z axis.														
	Y															
	Z															

14. Solderability						
Specified Value	NR30/40/50/60/80, NRV20/30, NRH24/30, NRS20/40/50/60/80 Type	At least 90% of surface of terminal electrode is covered by new solder.				
	NR10050 Type					
	NS101, NS125 Type					
Test Methods and Remarks	The test samples shall be dipped in flux, and then immersed in molten solder as shown in below table. Flux : Methanol solution containing rosin 25%. NR30/40/50/60/80, NRV20/30, NRH24/30, NRS20/40/50/60/80 Type, NR10050 Type, NS101/125 Type <table border="1" data-bbox="279 1691 702 1758"> <tr> <td>Solder Temperature</td> <td>245\pm5°C</td> </tr> <tr> <td>Time</td> <td>5\pm1.0 sec.</td> </tr> </table> ※Immersion depth : All sides of mounting terminal shall be immersed.		Solder Temperature	245 \pm 5°C	Time	5 \pm 1.0 sec.
Solder Temperature	245 \pm 5°C					
Time	5 \pm 1.0 sec.					

▶ This catalog contains the typical specification only due to the limitation of space. When you consider the purchase of our products, please check our specification.
 For details of each product (characteristics graph, reliability information, precautions for use, and so on), see our Web site (<http://www.ty-top.com/>).

15. Resistance to soldering heat		
Specified Value	NR30/40/50/60/80, NRV20/30, NRH24/30, NRS20/40/50/60/80 Type	Inductance change : Within $\pm 10\%$ No significant abnormality in appearance.
	NR10050 Type	
	NS101, NS125 Type	
Test Methods and Remarks	NR30/40/50/60/80, NRV20/30, NRH24/30, NRS20/40/50/60/80 Type, NR10050 Type, NS101/125 Type : The test sample shall be exposed to reflow oven at $230 \pm 5^\circ\text{C}$ for 40 seconds, with peak temperature at $260 \pm 5^\circ\text{C}$ for 5 seconds, 2 times. NR30/40/50/60/80, NRV20/30, NRH24/30, NRS20/40/50/60/80 Type, NS101/125 Type Test board material : Glass epoxy-resin Test board thickness : 1.0mm NR10050 Type Test board material : Glass epoxy-resin Test board thickness : 1.6mm Recovery : At least 2hrs of recovery under the standard condition after the test, followed by the measurement within 48hrs.	

16. Thermal shock																				
Specified Value	NR30/40/50/60/80, NRV20/30, NRH24/30, NRS20/40/50/60/80 Type	Inductance change : Within $\pm 10\%$ No significant abnormality in appearance.																		
	NR10050 Type																			
	NS101, NS125 Type																			
Test Methods and Remarks	NR30/40/50/60/80, NRV20/30, NRH24/30, NRS20/40/50/60/80 Type, NR10050 Type, NS101/125 Type : The test samples shall be soldered to the test board by the reflow. The test samples shall be placed at specified temperature for specified time by step 1 to step 4 as shown in below table in sequence. The temperature cycle shall be repeated 100 cycles. <table border="1" style="margin: 10px auto;"> <thead> <tr> <th colspan="3">Conditions of 1 cycle</th> </tr> <tr> <th>Step</th> <th>Temperature ($^\circ\text{C}$)</th> <th>Duration (min)</th> </tr> </thead> <tbody> <tr> <td>1</td> <td>-40 ± 3</td> <td>30 ± 3</td> </tr> <tr> <td>2</td> <td>Room temperature</td> <td>Within 3</td> </tr> <tr> <td>3</td> <td>$+85 \pm 2$</td> <td>30 ± 3</td> </tr> <tr> <td>4</td> <td>Room temperature</td> <td>Within 3</td> </tr> </tbody> </table> Recovery : At least 2hrs of recovery under the standard condition after the test, followed by the measurement within 48hrs.		Conditions of 1 cycle			Step	Temperature ($^\circ\text{C}$)	Duration (min)	1	-40 ± 3	30 ± 3	2	Room temperature	Within 3	3	$+85 \pm 2$	30 ± 3	4	Room temperature	Within 3
Conditions of 1 cycle																				
Step	Temperature ($^\circ\text{C}$)	Duration (min)																		
1	-40 ± 3	30 ± 3																		
2	Room temperature	Within 3																		
3	$+85 \pm 2$	30 ± 3																		
4	Room temperature	Within 3																		

17. Damp heat								
Specified Value	NR30/40/50/60/80, NRV20/30, NRH24/30, NRS20/40/50/60/80 Type	Inductance change : Within $\pm 10\%$ No significant abnormality in appearance.						
	NR10050 Type		—					
	NS101, NS125 Type	Inductance change : Within $\pm 10\%$ No significant abnormality in appearance.						
Test Methods and Remarks	NR30/40/50/60/80, NRV20/30, NRH24/30, NRS20/40/50/60/80 Type, NS101/125 Type : The test samples shall be soldered to the test board by the reflow. The test samples shall be placed in thermostatic oven set at specified temperature and humidity as shown in below table. <table border="1" style="margin: 10px auto;"> <tbody> <tr> <td>Temperature</td> <td>$60 \pm 2^\circ\text{C}$</td> </tr> <tr> <td>Humidity</td> <td>90~95%RH</td> </tr> <tr> <td>Time</td> <td>500+24/-0 hour</td> </tr> </tbody> </table> Recovery : At least 2hrs of recovery under the standard condition after the test, followed by the measurement within 48hrs.		Temperature	$60 \pm 2^\circ\text{C}$	Humidity	90~95%RH	Time	500+24/-0 hour
Temperature	$60 \pm 2^\circ\text{C}$							
Humidity	90~95%RH							
Time	500+24/-0 hour							

18. Loading under damp heat										
Specified Value	NR30/40/50/60/80, NRV20/30, NRH24/30, NRS20/40/50/60/80 Type	Inductance change : Within $\pm 10\%$ No significant abnormality in appearance.								
	NR10050 Type									
	NS101, NS125 Type									
Test Methods and Remarks	NR30/40/50/60/80, NRV20/30, NRH24/30, NRS20/40/50/60/80 Type, NR10050 Type, NS101/125 Type : The test samples shall be soldered to the test board by the reflow. The test samples shall be placed in thermostatic oven set at specified temperature and humidity and applied the rated current continuously as shown in below table. <table border="1" style="margin: 10px auto;"> <tbody> <tr> <td>Temperature</td> <td>$60 \pm 2^\circ\text{C}$</td> </tr> <tr> <td>Humidity</td> <td>90~95%RH</td> </tr> <tr> <td>Applied current</td> <td>Rated current</td> </tr> <tr> <td>Time</td> <td>500+24/-0 hour</td> </tr> </tbody> </table> Recovery : At least 2hrs of recovery under the standard condition after the test, followed by the measurement within 48hrs.		Temperature	$60 \pm 2^\circ\text{C}$	Humidity	90~95%RH	Applied current	Rated current	Time	500+24/-0 hour
Temperature	$60 \pm 2^\circ\text{C}$									
Humidity	90~95%RH									
Applied current	Rated current									
Time	500+24/-0 hour									

▶ This catalog contains the typical specification only due to the limitation of space. When you consider the purchase of our products, please check our specification.
 For details of each product (characteristics graph, reliability information, precautions for use, and so on), see our Web site (<http://www.ty-top.com/>).

19. Low temperature life test		
Specified Value	NR30/40/50/60/80, NRV20/30, NRH24/30, NRS20/40/50/60/80 Type	Inductance change : Within $\pm 10\%$ No significant abnormality in appearance.
	NR10050 Type	
	NS101, NS125 Type	
Test Methods and Remarks	NR30/40/50/60/80, NRV20/30, NRH24/30, NRS20/40/50/60/80 Type, NR10050 Type, NS101/125 Type : The test samples shall be soldered to the test board by the reflow. After that, the test samples shall be placed at test conditions as shown in below table.	
	Temperature	$-40 \pm 2^{\circ}\text{C}$
	Time	$500 + 24 / - 0$ hour
Recovery : At least 2hrs of recovery under the standard condition after the test, followed by the measurement within 48hrs.		
20. High temperature life test		
Specified Value	NR30/40/50/60/80, NRV20/30, NRH24/30, NRS20/40/50/60/80 Type	—
	NR10050 Type	—
	NS101, NS125 Type	—
Test Methods and Remarks	NR10050 Type :	
	Temperature	$105 \pm 3^{\circ}\text{C}$
	Time	$500 + 24 / - 0$ hour
Recovery : At least 2hrs of recovery under the standard condition after the test, followed by the measurement within 48hrs.		
21. Loading at high temperature life test		
Specified Value	NR30/40/50/60/80, NRV20/30, NRH24/30, NRS20/40/50/60/80 Type	Inductance change : Within $\pm 10\%$ No significant abnormality in appearance.
	NR10050 Type	—
	NS101, NS125 Type	Inductance change : Within $\pm 10\%$ No significant abnormality in appearance.
Test Methods and Remarks	NR30/40/50/60/80, NRV30, NRH24/30, NRS40/50/60/80 Type, NS12555, NS12565, NS12575 Type : The test samples shall be soldered to the test board by the reflow soldering.	
	Temperature	$85 \pm 2^{\circ}\text{C}$
	Applied current	Rated current
	Time	$500 + 24 / - 0$ hour
Recovery : At least 2hrs of recovery under the standard condition after the test, followed by the measurement within 48hrs.		
22. Standard condition		
Specified Value	NR30/40/50/60/80, NRV20/30, NRH24/30, NRS20/40/50/60/80 Type	Standard test condition : Unless otherwise specified, temperature is $20 \pm 15^{\circ}\text{C}$ and $65 \pm 20\%$ of relative humidity. When there is any question concerning measurement result: In order to provide correlation data, the test shall be condition of $20 \pm 2^{\circ}\text{C}$ of temperature, $65 \pm 5\%$ relative humidity. Inductance is in accordance with our measured value.
	NR10050 Type	
	NS101, NS125 Type	

SMD POWER INDUCTORS (NR□, NS SERIES)

PRECAUTIONS

1. Circuit Design

Precautions

◆ Operating environment

- The products described in this specification are intended for use in general electronic equipment, (office supply equipment, telecommunications systems, measuring equipment, and household equipment). They are not intended for use in mission-critical equipment or systems requiring special quality and high reliability (traffic systems, safety equipment, aerospace systems, nuclear control systems and medical equipment including life-support systems,) where product failure might result in loss of life, injury or damage. For such uses, contact TAIYO YUDEN Sales Department in advance.

2. PCB Design

Precautions

◆ Land pattern design

- Please refer to a recommended land pattern.
- There is stress, which has been caused by distortion of a PCB, to the inductor.
(NR30/40/50/60/80, NRV20/30, NRH24/30, NRS20/30/40/50/60/80 Type)
- Please consider the arrangement of parts on a PCB. (NR30/40/50/60/80, NRV20/30, NRH24/30, NRS20/30/40/50/60/80 Type)

Technical considerations

◆ Land pattern design

Surface Mounting

- Mounting and soldering conditions should be checked beforehand.
- Applicable soldering process to this products is reflow soldering only.
- Please use the recommended land pattern shown as below. Electrical characteristics and the mounting ability of the product are being considered in the recommended land pattern. If a PCB is designed with other dimensions, defective soldering and stress to a product may occur due to misalignment. The performance of the product may not be brought out. If an adopted land pattern is different from the recommended land pattern, stress to the product will increase. It may cause cracks or defective electrical characteristics of the product. Please conduct validation completely before studying adoption of this product and please judge the pros and cons of adoption of this product with taking on responsibility.
(NR30/40/50/60/80, NRV20/30, NRH24/30, NRS20/30/40/50/60/80 Type)
- As coefficients of thermal expansion between an inductor and a PCB differs, cracks may occur on a ferrite core when thermal stress is applied to them after mounting an inductor. (Please refer to the drawings below.) Please conduct validation completely before studying adoption of this product and please judge the pros and cons of adoption of this product with taking on responsibility.
(NR30/40/50/60/80, NRV20/30, NRH24/30, NRS20/30/40/50/60/80 Type)

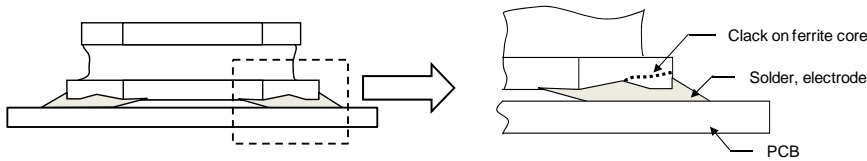

- SMD inductors should be located to minimize any possible mechanical stresses from board warp or deflection. When splitting the PCB board after mounting inductors and other components, care is required so as not to give any stresses of deflection or twisting to the board.
(NR30/40/50/60/80, NRV20/30, NRH24/30, NRS20/30/40/50/60/80 Type)

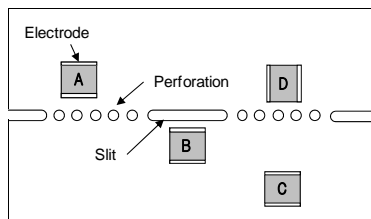

A product tends to undergo stress in order "A>C>B≡D".
Please consider the layouts of a product to minimize any stresses.

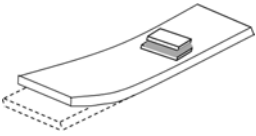
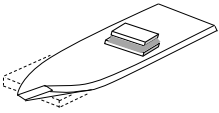
3. Considerations for automatic placement	
Precautions	<ul style="list-style-type: none"> ◆Adjustment of mounting machine <ol style="list-style-type: none"> 1. Excessive impact load should not be imposed on the products when mounting onto the PC boards. 2. Mounting and soldering conditions should be checked beforehand.
Technical considerations	<ul style="list-style-type: none"> ◆Adjustment of mounting machine <ol style="list-style-type: none"> 1. When installing products, care should be taken not to apply distortion stress as it may deform the products. 2. Stress may be applied to a product with a warp or a twist in handling of the product. Please conduct validation completely before studying adoption of this product and please judge the pros and cons of adoption of this product with taking on responsibility. (NR30/40/50/60/80, NRV20/30, NRH24/30, NRS20/30/40/50/60/80 Type) <div style="display: flex; justify-content: space-around; align-items: center;"> <div style="text-align: center;"> <p><Wrap></p>  </div> <div style="text-align: center;"> <p><Twist></p>  </div> </div>

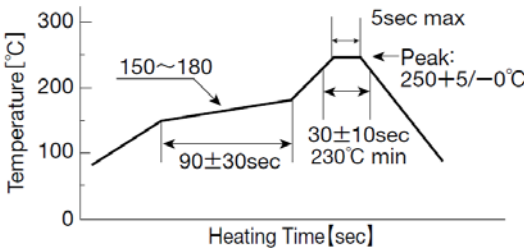
4. Soldering	
Precautions	<ul style="list-style-type: none"> ◆Reflow soldering <ol style="list-style-type: none"> 1. Please contact any of our offices for a reflow soldering, and refer to the recommended condition specified. 2. The product shall be used reflow soldering only. 3. Please do not add any stress to a product until it returns in normal temperature after reflow soldering. ◆Lead free soldering <ol style="list-style-type: none"> 1. When using products with lead free soldering, we request to use them after confirming adhesion, temperature of resistance to soldering heat, soldering etc sufficiently. ◆Recommended conditions for using a soldering iron (NR10050 Type) <ul style="list-style-type: none"> • Put the soldering iron on the land-pattern. • Soldering iron's temperature – Below 350°C • Duration – 3 seconds or less • The soldering iron should not directly touch the inductor.
Technical considerations	<ul style="list-style-type: none"> ◆Reflow soldering <ol style="list-style-type: none"> 1. If products are used beyond the range of the recommended conditions, heat stresses may deform the products, and consequently degrade the reliability of the products. <ul style="list-style-type: none"> •NR30/40/50/60/80, NRV20/30, NRH24/30, NRS20/40/50/60/80 Type, NR10050 Type, NS101/125 Type <p>Recommended reflow condition (Pb free solder)</p> 

5. Cleaning	
Precautions	<ul style="list-style-type: none"> ◆Cleaning conditions <ol style="list-style-type: none"> 1. Washing by supersonic waves shall be avoided.
Technical considerations	<ul style="list-style-type: none"> ◆Cleaning conditions <ol style="list-style-type: none"> 1. If washed by supersonic waves, the products might be broken.

6. Handling	
Precautions	<ul style="list-style-type: none"> ◆ Handling <ol style="list-style-type: none"> 1. Keep the product away from all magnets and magnetic objects. ◆ Breakaway PC boards (splitting along perforations) <ol style="list-style-type: none"> 1. When splitting the PC board after mounting product, care should be taken not to give any stresses of deflection or twisting to the board. 2. Board separation should not be done manually, but by using the appropriate devices. ◆ Mechanical considerations <ol style="list-style-type: none"> 1. Please do not give the product any excessive mechanical shocks. 2. Please do not add any shock and power to a product in transportation. ◆ Pick-up pressure <ol style="list-style-type: none"> 1. Please do not push to add any pressure to a winding part. Please do not give any shock and push into a ferrite core exposure part. ◆ Packing <ol style="list-style-type: none"> 1. Please avoid accumulation of a packing box as much as possible.
Technical considerations	<ul style="list-style-type: none"> ◆ Handling <ol style="list-style-type: none"> 1. There is a case that a characteristic varies with magnetic influence. ◆ Breakaway PC boards (splitting along perforations) <ol style="list-style-type: none"> 1. The position of the product on PCBs shall be carefully considered to minimize the stress caused from splitting of the PCBs. ◆ Mechanical considerations <ol style="list-style-type: none"> 1. There is a case to be damaged by a mechanical shock. 2. There is a case to be broken by the handling in transportation. ◆ Pick-up pressure <ol style="list-style-type: none"> 1. Damage and a characteristic can vary with an excessive shock or stress. ◆ Packing <ol style="list-style-type: none"> 1. If packing boxes are accumulated, that could cause a deformation on packing tapes or a damage on the products.
7. Storage conditions	
Precautions	<ul style="list-style-type: none"> ◆ Storage <ol style="list-style-type: none"> 1. To maintain the solderability of terminal electrodes and to keep the packing material in good condition, temperature and humidity in the storage area should be controlled. <ul style="list-style-type: none"> ▪ Recommended conditions <ul style="list-style-type: none"> Ambient temperature : $-5\sim 40^{\circ}\text{C}$ Humidity : Below 70% RH ▪ The ambient temperature must be kept below 30°C. Even under ideal storage conditions, solderability of products electrodes may decrease as time passes. <p style="margin-left: 20px;">For this reason, product should be used within 6 months from the time of delivery.</p> <p style="margin-left: 20px;">In case of storage over 6 months, solderability shall be checked before actual usage.</p>
Technical considerations	<ul style="list-style-type: none"> ◆ Storage <ol style="list-style-type: none"> 1. Under a high temperature and humidity environment, problems such as reduced solderability caused by oxidation of terminal electrodes and deterioration of taping/packaging materials may take place.

SMD POWER INDUCTORS(NS SERIES)



REFLOW

■ PARTS NUMBER

* Operating Temp.: -40~+125°C (Including self-generated heat)

N	S	△	1	0	1	4	5	T	△	1	0	0	M	N	A
①			②					③		④			⑤		⑥

△=Blank space

① Series name

Code	Series name
NS△	Shielded specification

② Dimensions (L × W × H)

Code	Dimensions (L × W × H) [mm]
10145	10.1 × 10.1 × 4.5
10155	10.1 × 10.1 × 5.5
10165	10.1 × 10.1 × 6.5
12555	12.5 × 12.5 × 5.5
12565	12.5 × 12.5 × 6.5
12575	12.5 × 12.5 × 7.5

③ Packaging

Code	Packaging
T△	Taping

④ Nominal inductance

Code (example)	Nominal inductance [μH]
1R0	1.0
100	10
101	100

※R=Decimal point

⑤ Inductance tolerance

Code	Inductance tolerance
M	±20%
N	±30%

⑥ Internal code

Code	Internal code
N△	Internal code
NA	

■ STANDARD EXTERNAL DIMENSIONS / MINIMUM QUANTITY

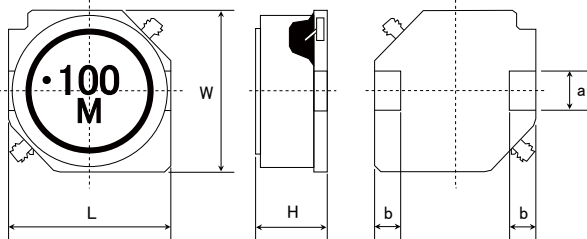

※ The NS 101□□ type does not have the indication of the Manufacturing date code.

Type	L	W	H	a	b	Minimum quantity [pcs]
NS 10145	10.1±0.3 (0.398±0.012)	10.1±0.3 (0.398±0.012)	4.5±0.35 (0.177±0.014)	2.8±0.1 (0.110±0.004)	2.0±0.15 (0.079±0.006)	2000
NS 10155	10.1±0.3 (0.398±0.012)	10.1±0.3 (0.398±0.012)	5.5±0.35 (0.217±0.014)	2.8±0.1 (0.110±0.004)	2.0±0.15 (0.079±0.006)	2000
NS 10165	10.1±0.3 (0.398±0.012)	10.1±0.3 (0.398±0.012)	6.5±0.35 (0.256±0.014)	2.8±0.1 (0.110±0.004)	2.0±0.15 (0.079±0.006)	2000
NS 12555	12.5±0.3 (0.492±0.012)	12.5±0.3 (0.492±0.012)	5.5±0.35 (0.217±0.014)	3.0±0.1 (0.118±0.004)	2.0±0.15 (0.079±0.006)	2000
NS 12565	12.5±0.3 (0.492±0.012)	12.5±0.3 (0.492±0.012)	6.5±0.35 (0.256±0.014)	3.0±0.1 (0.118±0.004)	2.0±0.15 (0.079±0.006)	2000
NS 12575	12.5±0.3 (0.492±0.012)	12.5±0.3 (0.492±0.012)	7.5±0.35 (0.295±0.014)	3.0±0.1 (0.118±0.004)	2.0±0.15 (0.079±0.006)	2000

Unit : mm (inch)

Recommended Land Patterns

Surface Mounting

- Mounting and soldering conditions should be checked beforehand.
- Applicable soldering process to these products is reflow soldering only.

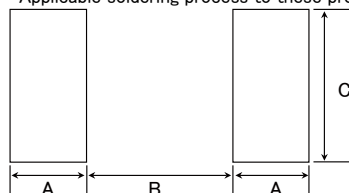

Type	A	B	C
NS 10145	2.5	5.6	3.2
NS 10155	2.5	5.6	3.2
NS 10165	2.5	5.6	3.2
NS 12555	2.5	8.6	3.2
NS 12565	2.5	8.6	3.2
NS 12575	2.5	8.6	3.2

Unit : mm

▶ This catalog contains the typical specification only due to the limitation of space. When you consider the purchase of our products, please check our product specification sheets. For details of each product (characteristics graph, reliability information, precautions for use, and so on), see our website (<http://www.ty-top.com/>).

PARTS NUMBER

● NS 10145 type

Parts number	EHS	Nominal inductance [μ H]	Inductance tolerance	DC Resistance [Ω] ($\pm 20\%$)	Rated current ※) [A]		Measuring frequency [kHz]
					Saturation current Idc1	Temperature rise current Idc2	
NS 10145T 1R0NNA	RoHS	1.0	$\pm 30\%$	0.0049	12.54	8.90	100
NS 10145T 1R5NNA	RoHS	1.5	$\pm 30\%$	0.0060	10.34	7.99	100
NS 10145T 2R2NNA	RoHS	2.2	$\pm 30\%$	0.0085	8.91	6.64	100
NS 10145T 3R3NNA	RoHS	3.3	$\pm 30\%$	0.0100	7.33	6.10	100
NS 10145T 4R7NNA	RoHS	4.7	$\pm 30\%$	0.0144	6.69	5.03	100
NS 10145T 5R6NNA	RoHS	5.6	$\pm 30\%$	0.0181	5.85	4.45	100
NS 10145T 6R8NNA	RoHS	6.8	$\pm 30\%$	0.0200	5.05	4.22	100
NS 10145T 100MNA	RoHS	10	$\pm 20\%$	0.0248	4.22	3.77	100
NS 10145T 150MNA	RoHS	15	$\pm 20\%$	0.0381	3.44	3.00	100
NS 10145T 220MNA	RoHS	22	$\pm 20\%$	0.0520	2.87	2.55	100
NS 10145T 330MNA	RoHS	33	$\pm 20\%$	0.0815	2.36	2.01	100
NS 10145T 470MNA	RoHS	47	$\pm 20\%$	0.100	1.85	1.80	100
NS 10145T 680MNA	RoHS	68	$\pm 20\%$	0.150	1.66	1.45	100
NS 10145T 101MNA	RoHS	100	$\pm 20\%$	0.200	1.29	1.25	100
NS 10145T 151MNA	RoHS	150	$\pm 20\%$	0.341	1.11	0.94	100
NS 10145T 221MNA	RoHS	220	$\pm 20\%$	0.485	0.91	0.78	100
NS 10145T 331MNA	RoHS	330	$\pm 20\%$	0.700	0.71	0.64	100
NS 10145T 471MNA	RoHS	470	$\pm 20\%$	1.030	0.61	0.52	100
NS 10145T 681MNA	RoHS	680	$\pm 20\%$	1.57	0.50	0.42	100
NS 10145T 102MNA	RoHS	1000	$\pm 20\%$	2.58	0.41	0.32	100
NS 10145T 152MNA	RoHS	1500	$\pm 20\%$	3.70	0.36	0.27	100

● NS 10155 type

Parts number	EHS	Nominal inductance [μ H]	Inductance tolerance	DC Resistance [Ω] ($\pm 20\%$)	Rated current ※) [A]		Measuring frequency [kHz]
					Saturation current Idc1	Temperature rise current Idc2	
NS 10155T 1R5NNA	RoHS	1.5	$\pm 30\%$	0.0060	11.90	8.39	100
NS 10155T 2R2NNA	RoHS	2.2	$\pm 30\%$	0.0072	10.00	7.61	100
NS 10155T 3R3NNA	RoHS	3.3	$\pm 30\%$	0.0097	8.50	6.49	100
NS 10155T 4R7NNA	RoHS	4.7	$\pm 30\%$	0.0112	7.40	6.01	100
NS 10155T 6R8NNA	RoHS	6.8	$\pm 30\%$	0.0159	6.00	4.98	100
NS 10155T 100MNA	RoHS	10	$\pm 20\%$	0.0200	4.49	4.40	100
NS 10155T 150MNA	RoHS	15	$\pm 20\%$	0.0284	4.03	3.65	100
NS 10155T 220MNA	RoHS	22	$\pm 20\%$	0.0380	3.37	3.12	100

● NS 10165 type

Parts number	EHS	Nominal inductance [μ H]	Inductance tolerance	DC Resistance [Ω] ($\pm 20\%$)	Rated current ※) [A]		Measuring frequency [kHz]
					Saturation current Idc1	Temperature rise current Idc2	
NS 10165T 1R5NNA	RoHS	1.5	$\pm 30\%$	0.0062	13.60	8.04	100
NS 10165T 2R2NNA	RoHS	2.2	$\pm 30\%$	0.0074	10.80	7.32	100
NS 10165T 3R3NNA	RoHS	3.3	$\pm 30\%$	0.0086	9.30	6.76	100
NS 10165T 4R7NNA	RoHS	4.7	$\pm 30\%$	0.0112	7.70	5.88	100
NS 10165T 6R8NNA	RoHS	6.8	$\pm 30\%$	0.0140	6.00	5.22	100
NS 10165T 100MNA	RoHS	10	$\pm 20\%$	0.0174	5.20	4.66	100
NS 10165T 150MNA	RoHS	15	$\pm 20\%$	0.0250	4.50	3.84	100
NS 10165T 220MNA	RoHS	22	$\pm 20\%$	0.0313	3.60	3.41	100

● NS 12555 type

Parts number	EHS	Nominal inductance [μ H]	Inductance tolerance	DC Resistance [Ω] ($\pm 20\%$)	Rated current ※) [A]		Measuring frequency [kHz]
					Saturation current Idc1	Temperature rise current Idc2	
NS 12555T 6R0NN	RoHS	6.0	$\pm 30\%$	0.0140	5.01	5.60	100
NS 12555T 100MN	RoHS	10	$\pm 20\%$	0.0175	4.73	5.04	100
NS 12555T 150MN	RoHS	15	$\pm 20\%$	0.0233	3.89	4.18	100
NS 12555T 220MN	RoHS	22	$\pm 20\%$	0.0297	3.20	3.81	100
NS 12555T 330MN	RoHS	33	$\pm 20\%$	0.0415	2.64	3.16	100
NS 12555T 470MN	RoHS	47	$\pm 20\%$	0.0551	2.23	2.70	100
NS 12555T 680MN	RoHS	68	$\pm 20\%$	0.0797	1.81	2.14	100
NS 12555T 101MN	RoHS	100	$\pm 20\%$	0.117	1.53	1.86	100
NS 12555T 151MN	RoHS	150	$\pm 20\%$	0.176	1.22	1.43	100
NS 12555T 221MN	RoHS	220	$\pm 20\%$	0.270	1.00	1.18	100
NS 12555T 331MN	RoHS	330	$\pm 20\%$	0.410	0.82	0.96	100
NS 12555T 471MN	RoHS	470	$\pm 20\%$	0.520	0.68	0.80	100
NS 12555T 681MN	RoHS	680	$\pm 20\%$	0.760	0.60	0.72	100
NS 12555T 102MN	RoHS	1000	$\pm 20\%$	1.12	0.47	0.59	100
NS 12555T 152MN	RoHS	1500	$\pm 20\%$	1.73	0.40	0.44	100

※) The saturation current value (Idc1) is the DC current value having inductance decrease down to 30%. (at 20°C)

※) The temperature rise current value (Idc2) is the DC current value having temperature increase up to 40°C. (at 20°C)

※) The rated current is the DC current value that satisfies both of current value saturation current value and temperature rise current value.

PARTS NUMBER

● NS 12565 type

Parts number	EHS	Nominal inductance [μ H]	Inductance tolerance	DC Resistance [Ω] ($\pm 20\%$)	Rated current ※) [A]		Measuring frequency [kHz]
					Saturation current Idc1	Temperature rise current Idc2	
NS 12565T 2R0NN	RoHS	2.0	$\pm 30\%$	0.0080	13.91	7.60	100
NS 12565T 4R2NN	RoHS	4.2	$\pm 30\%$	0.0126	10.15	5.91	100
NS 12565T 7R0NN	RoHS	7.0	$\pm 30\%$	0.0162	7.93	5.21	100
NS 12565T 100MN	RoHS	10	$\pm 20\%$	0.0199	6.96	4.75	100
NS 12565T 150MN	RoHS	15	$\pm 20\%$	0.0237	5.84	4.33	100
NS 12565T 220MN	RoHS	22	$\pm 20\%$	0.0310	4.87	3.91	100
NS 12565T 330MN	RoHS	33	$\pm 20\%$	0.0390	3.89	3.22	100
NS 12565T 470MN	RoHS	47	$\pm 20\%$	0.0575	3.34	2.78	100
NS 12565T 680MN	RoHS	68	$\pm 20\%$	0.0775	2.78	2.30	100
NS 12565T 101MN	RoHS	100	$\pm 20\%$	0.123	2.23	1.81	100
NS 12565T 151MN	RoHS	150	$\pm 20\%$	0.173	1.84	1.54	100
NS 12565T 221MN	RoHS	220	$\pm 20\%$	0.273	1.39	1.18	100

● NS 12575 type

Parts number	EHS	Nominal inductance [μ H]	Inductance tolerance	DC Resistance [Ω] ($\pm 20\%$)	Rated current ※) [A]		Measuring frequency [kHz]
					Saturation current Idc1	Temperature rise current Idc2	
NS 12575T 1R2NN	RoHS	1.2	$\pm 30\%$	0.0058	18.08	9.15	100
NS 12575T 2R7NN	RoHS	2.7	$\pm 30\%$	0.0085	13.91	7.69	100
NS 12575T 3R9NN	RoHS	3.9	$\pm 30\%$	0.0099	12.52	7.38	100
NS 12575T 5R6NN	RoHS	5.6	$\pm 30\%$	0.0116	10.85	6.36	100
NS 12575T 6R8NN	RoHS	6.8	$\pm 30\%$	0.0131	10.02	5.84	100
NS 12575T 100MN	RoHS	10	$\pm 20\%$	0.0156	7.65	5.55	100
NS 12575T 150MN	RoHS	15	$\pm 20\%$	0.0184	6.54	5.22	100
NS 12575T 220MN	RoHS	22	$\pm 20\%$	0.0260	5.56	4.05	100
NS 12575T 330MN	RoHS	33	$\pm 20\%$	0.0390	4.45	3.48	100
NS 12575T 470MN	RoHS	47	$\pm 20\%$	0.0515	3.76	2.95	100
NS 12575T 680MN	RoHS	68	$\pm 20\%$	0.0720	2.78	2.49	100
NS 12575T 101MN	RoHS	100	$\pm 20\%$	0.110	2.64	2.01	100
NS 12575T 151MN	RoHS	150	$\pm 20\%$	0.161	2.09	1.51	100
NS 12575T 221MN	RoHS	220	$\pm 20\%$	0.245	1.81	1.35	100

※) The saturation current value (Idc1) is the DC current value having inductance decrease down to 30%. (at 20°C)

※) The temperature rise current value (Idc2) is the DC current value having temperature increase up to 40°C. (at 20°C)

※) The rated current is the DC current value that satisfies both of current value saturation current value and temperature rise current value.

SMD POWER INDUCTORS (NS SERIES)

PACKAGING

① Packing Quantity

Type	Standard Quantity (1reel) [pcs]	Minimum Quantity [pcs]
	Embossed Tape	Embossed Tape
NS10145	500	2000
NS10155	500	2000
NS10165	500	2000
NS12555	500	2000
NS12565	500	2000
NS12575	500	2000

② Tape Material

● Embossed Tape

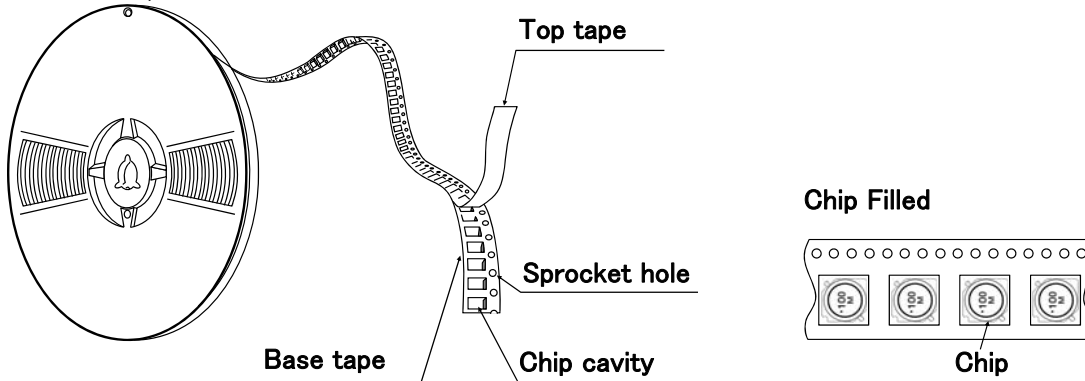

③ Taping dimensions

● Embossed tape 24mm wide (0.945 inches wide)

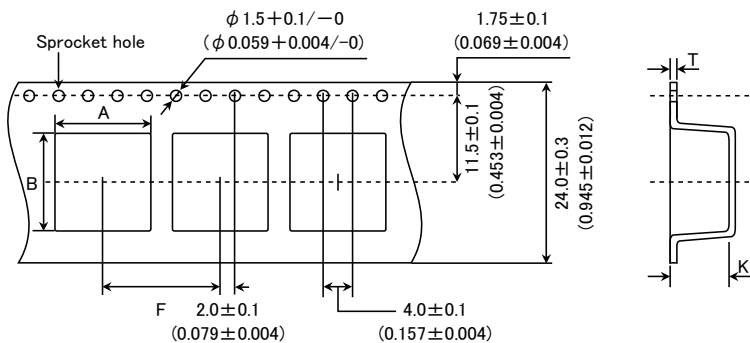

Type	Chip cavity		Insertion pitch	Tape thickness	
	A	B	F	T	K
NS10145	10.5 ± 0.1 (0.413 ± 0.004)	10.5 ± 0.1 (0.413 ± 0.004)	16.0 ± 0.1 (0.630 ± 0.004)	0.4 ± 0.1 (0.016 ± 0.004)	5.0 ± 0.1 (0.197 ± 0.004)
NS10155	10.5 ± 0.1 (0.413 ± 0.004)	10.5 ± 0.1 (0.413 ± 0.004)	16.0 ± 0.1 (0.630 ± 0.004)	0.4 ± 0.1 (0.016 ± 0.004)	6.0 ± 0.1 (0.236 ± 0.004)
NS10165	10.5 ± 0.1 (0.413 ± 0.004)	10.5 ± 0.1 (0.413 ± 0.004)	16.0 ± 0.1 (0.630 ± 0.004)	0.4 ± 0.1 (0.016 ± 0.004)	7.0 ± 0.1 (0.276 ± 0.004)
NS12555	13.0 ± 0.1 (0.512 ± 0.004)	13.0 ± 0.1 (0.512 ± 0.004)	16.0 ± 0.1 (0.630 ± 0.004)	0.4 ± 0.1 (0.016 ± 0.004)	6.1 ± 0.1 (0.240 ± 0.004)
NS12565	13.0 ± 0.1 (0.512 ± 0.004)	13.0 ± 0.1 (0.512 ± 0.004)	16.0 ± 0.1 (0.630 ± 0.004)	0.4 ± 0.1 (0.016 ± 0.004)	7.1 ± 0.1 (0.280 ± 0.004)
NS12575	13.0 ± 0.1 (0.512 ± 0.004)	13.0 ± 0.1 (0.512 ± 0.004)	16.0 ± 0.1 (0.630 ± 0.004)	0.4 ± 0.1 (0.016 ± 0.004)	8.0 ± 0.1 (0.315 ± 0.004)

Unit : mm (inch)

▶ This catalog contains the typical specification only due to the limitation of space. When you consider the purchase of our products, please check our specification. For details of each product (characteristics graph, reliability information, precautions for use, and so on), see our Web site (<http://www.ty-top.com/>).

④ Leader and Blank portion

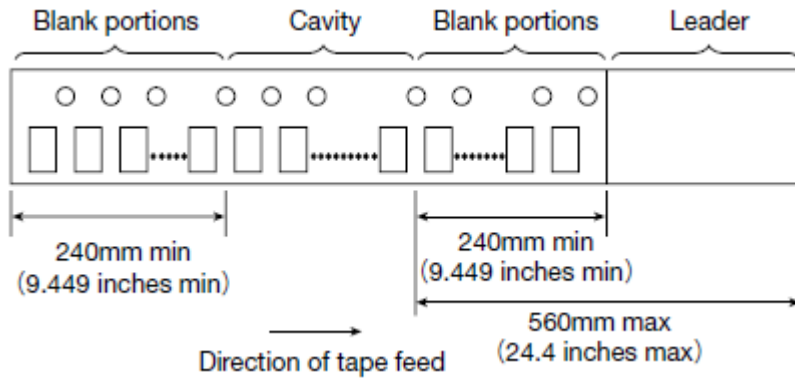

⑤ Reel size

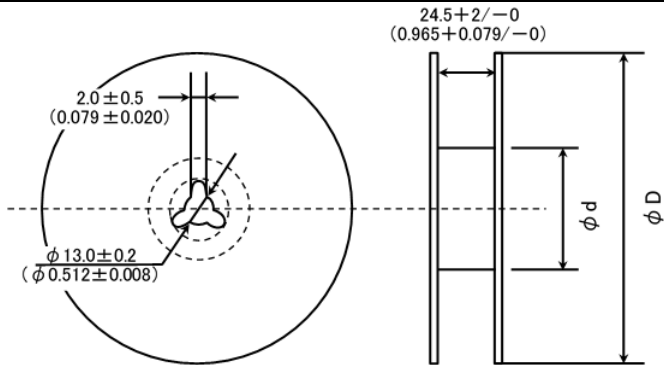

Type	Reel size (Reference values)	
	ϕD	ϕd
NS10145	330 ± 2 (12.99 ± 0.079)	100 ± 1 (3.937 ± 0.039)
NS10155		
NS10165		
NS12555		
NS12565		
NS12575		

Unit: mm (inch)

⑥ Top Tape Strength

The top tape requires a peel-off force of 0.1 to 1.3N in the direction of the arrow as illustrated below.

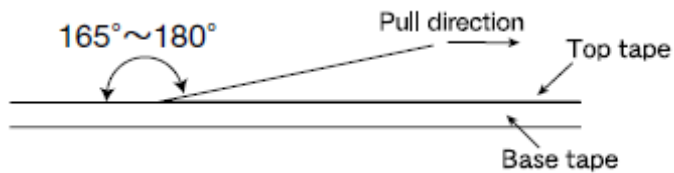

SMD POWER INDUCTORS (NR□, NS SERIES)

RELIABILITY DATA

1. Operating Temperature Range		
Specified Value	NR30/40/50/60/80, NRS20, NRV20/30, NRH24/30 Type	-25~+120°C
	NRS40/50/60/80 Type	-25~+125°C
	NR10050 Type	-25~+105°C
	NS101, NS125 Type	-40~+125°C
Test Methods and Remarks	Including self-generated heat	
2. Storage Temperature Range		
Specified Value	NR30/40/50/60/80, NRV20/30, NRH24/30, NRS20/40/50/60/80 Type	-40~+85°C
	NR10050 Type	
	NS101, NS125 Type	
Test Methods and Remarks	NR30/40/50/60/80, NRV20/30, NRH24/30, NRS20/40/50/60/80 Type, NR10050 Type, NS101/125 Type : -5 to 40°C for the product with taping.	
3. Rated current		
Specified Value	NR30/40/50/60/80, NRV20/30, NRH24/30, NRS20/40/50/60/80 Type	Within the specified tolerance
	NR10050 Type	
	NS101, NS125 Type	
4. Inductance		
Specified Value	NR30/40/50/60/80, NRV20/30, NRH24/30, NRS20/40/50/60/80 Type	Within the specified tolerance
	NR10050 Type	
	NS101, NS125 Type	
Test Methods and Remarks	Measuring equipment : LCR Meter (HP 4285A or equivalent) Measuring frequency : Specified frequency NR30/40/50/60/80, NRV20/30, NRH24/30, NRS20/40/50/60/80 Type, NR10050 Type, NS101/125 Type : Measuring equipment : LCR Meter (HP 4285A or equivalent) Measuring frequency : 100kHz, 1V NR10050 Type : Measuring equipment : LCR Meter (HP 4263A or equivalent) Measuring frequency : 100kHz, 1V	
5. DC Resistance		
Specified Value	NR30/40/50/60/80, NRV20/30, NRH24/30, NRS20/40/50/60/80 Type	Within the specified tolerance
	NR10050 Type	
	NS101, NS125 Type	
Test Methods and Remarks	Measuring equipment : DC ohmmeter (HIOKI 3227 or equivalent)	
6. Self resonance frequency		
Specified Value	NR30/40/50/60/80, NRV30, NRH24/30, NRS40/50/60/80 Type	Within the specified tolerance
	NR10050 Type	
	NS101, NS125 Type	-
Test Methods and Remarks	NR30/40/50/60/80, NRV30, NRH24/30, NRS40/50/60/80 Type, NR10050 Type : Measuring equipment : Impedance analyzer/material analyzer (HP4291A or equivalent HP4191A, 4192A or equivalent)	

▶ This catalog contains the typical specification only due to the limitation of space. When you consider the purchase of our products, please check our specification.
 For details of each product (characteristics graph, reliability information, precautions for use, and so on), see our Web site (<http://www.ty-top.com/>).

7. Temperature characteristic														
Specified Value	NR30/40/50/60/80, NRV20/30, NRH24/30, NRS20/40/50/60/80 Type	Inductance change : Within $\pm 20\%$												
	NR10050 Type													
	NS101, NS125 Type	Inductance change : Within $\pm 15\%$												
Test Methods and Remarks	NR30/40/50/60/80, NRV20/30, NRH24/30, NRS20/40/50/60/80 Type, NR10050 Type : Measurement of inductance shall be taken at temperature range within $-25^{\circ}\text{C}\sim +85^{\circ}\text{C}$. With reference to inductance value at $+20^{\circ}\text{C}$., change rate shall be calculated.													
	NS101, NS125 Type : Measurement of inductance shall be taken at temperature range within $-40^{\circ}\text{C}\sim +125^{\circ}\text{C}$. With reference to inductance value at $+20^{\circ}\text{C}$., change rate shall be calculated. Change of maximum inductance deviation in step 1 to 5													
	<table border="1"> <thead> <tr> <th>Step</th> <th>Temperature ($^{\circ}\text{C}$)</th> </tr> </thead> <tbody> <tr> <td>1</td> <td>20</td> </tr> <tr> <td>2</td> <td>Minimum operating temperature</td> </tr> <tr> <td>3</td> <td>20 (Standard temperature)</td> </tr> <tr> <td>4</td> <td>Maximum operating temperature</td> </tr> <tr> <td>5</td> <td>20</td> </tr> </tbody> </table>	Step	Temperature ($^{\circ}\text{C}$)	1	20	2	Minimum operating temperature	3	20 (Standard temperature)	4	Maximum operating temperature	5	20	
Step	Temperature ($^{\circ}\text{C}$)													
1	20													
2	Minimum operating temperature													
3	20 (Standard temperature)													
4	Maximum operating temperature													
5	20													

8. Resistance to flexure of substrate																																												
Specified Value	NR30/40/50/60/80, NRV20/30, NRH24/30, NRS20/40/50/60/80 Type	No damage																																										
	NR10050 Type	—																																										
	NS101, NS125 Type	No damage																																										
Test Methods and Remarks	NR30/40/50/60/80, NRV20/30, NRH24/30, NRS20/40/50/60/80 Type, NS101/125 Type : The test samples shall be soldered to the test board by the reflow. As illustrated below, apply force in the direction of the arrow indicating until deflection of the test board reaches to 2 mm. Test board size : $100 \times 40 \times 1.0$ Test board material : Glass epoxy-resin Solder cream thickness : 0.10mm (NR30, NRS20, NRH24/30, NRV20/30) : 0.15mm (NR40/50/60/80, NRS40/50/60, NS101/125Type)																																											
	<div style="display: flex; align-items: flex-start;"> <div style="margin-right: 20px;"> <p>Land dimension</p>  </div> <table border="1"> <thead> <tr> <th>Type</th> <th>A</th> <th>B</th> <th>C</th> </tr> </thead> <tbody> <tr> <td>NRS20, NRV20</td> <td>0.65</td> <td>0.7</td> <td>2.0</td> </tr> <tr> <td>NRH24</td> <td>0.7</td> <td>0.75</td> <td>2.0</td> </tr> <tr> <td>NR30, NRV30, NRH30</td> <td>0.8</td> <td>1.4</td> <td>2.7</td> </tr> <tr> <td>NR40, NRS40</td> <td>1.2</td> <td>1.6</td> <td>3.7</td> </tr> <tr> <td>NR50, NRS50</td> <td>1.5</td> <td>2.1</td> <td>4.0</td> </tr> <tr> <td>NR60, NRS60</td> <td>1.6</td> <td>3.1</td> <td>5.7</td> </tr> <tr> <td>NR80, NRS80</td> <td>1.8</td> <td>3.8</td> <td>7.5</td> </tr> </tbody> </table> </div> <div style="margin-left: 20px;">  <table border="1"> <thead> <tr> <th>Type</th> <th>A</th> <th>B</th> <th>C</th> </tr> </thead> <tbody> <tr> <td>NS101</td> <td>2.5</td> <td>5.6</td> <td>3.2</td> </tr> <tr> <td>NS125</td> <td>2.5</td> <td>8.6</td> <td>3.2</td> </tr> </tbody> </table> </div>	Type	A	B	C	NRS20, NRV20	0.65	0.7	2.0	NRH24	0.7	0.75	2.0	NR30, NRV30, NRH30	0.8	1.4	2.7	NR40, NRS40	1.2	1.6	3.7	NR50, NRS50	1.5	2.1	4.0	NR60, NRS60	1.6	3.1	5.7	NR80, NRS80	1.8	3.8	7.5	Type	A	B	C	NS101	2.5	5.6	3.2	NS125	2.5	8.6
Type	A	B	C																																									
NRS20, NRV20	0.65	0.7	2.0																																									
NRH24	0.7	0.75	2.0																																									
NR30, NRV30, NRH30	0.8	1.4	2.7																																									
NR40, NRS40	1.2	1.6	3.7																																									
NR50, NRS50	1.5	2.1	4.0																																									
NR60, NRS60	1.6	3.1	5.7																																									
NR80, NRS80	1.8	3.8	7.5																																									
Type	A	B	C																																									
NS101	2.5	5.6	3.2																																									
NS125	2.5	8.6	3.2																																									

9. Insulation resistance : between wires		
Specified Value	NR30/40/50/60/80, NRV20/30, NRH24/30, NRS20/40/50/60/80 Type	—
	NR10050 Type	
	NS101, NS125 Type	

10. Insulation resistance : between wire and core		
Specified Value	NR30/40/50/60/80, NRV20/30, NRH24/30, NRS20/40/50/60/80 Type	—
	NR10050 Type	
	NS101, NS125 Type	

▶ This catalog contains the typical specification only due to the limitation of space. When you consider the purchase of our products, please check our specification.
For details of each product (characteristics graph, reliability information, precautions for use, and so on), see our Web site (<http://www.ty-top.com/>).

11. Withstanding voltage : between wire and core		
Specified Value	NR30/40/50/60/80, NRV20/30, NRH24/30, NRS20/40/50/60/80 Type	—
	NR10050 Type	
	NS101, NS125 Type	

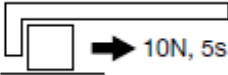
12. Adhesion of terminal electrode		
Specified Value	NR30/40/50/60/80, NRV20/30, NRH24/30, NRS20/40/50/60/80 Type	Shall not come off PC board
	NR10050 Type	
	NS101, NS125 Type	
Test Methods and Remarks	NR30/40/50/60/80, NRV20/30, NRH24/30, NRS20/40/50/60/80 Type, NS101/125 Type : The test samples shall be soldered to the test board by the reflow. Applied force : 10N to X and Y directions. Duration : 5s. Solder cream thickness : 0.10mm (NR30, NRS20, NRH24/30, NRV20/30) : 0.15mm (NR40/50/60/80, NRS40/50/60, NS101/125Type)	
	 NR10050 Type Applied force : 5N to X and Y directions. Duration : 5s.	

13. Resistance to vibration															
Specified Value	NR30/40/50/60/80, NRV20/30, NRH24/30, NRS20/40/50/60/80 Type	Inductance change : Within $\pm 10\%$ No significant abnormality in appearance.													
	NR10050 Type														
	NS101, NS125 Type														
Test Methods and Remarks	NR30/40/50/60/80, NRV20/30, NRH24/30, NRS20/40/50/60/80 Type, NR10050 Type, NS101/125 Type : The test samples shall be soldered to the test board by the reflow. Then it shall be submitted to below test conditions.														
	<table border="1" data-bbox="295 1167 1131 1341"> <tr> <td>Frequency Range</td> <td colspan="2">10~55Hz</td> </tr> <tr> <td>Total Amplitude</td> <td colspan="2">1.5mm (May not exceed acceleration 196m/s²)</td> </tr> <tr> <td>Sweeping Method</td> <td colspan="2">10Hz to 55Hz to 10Hz for 1min.</td> </tr> <tr> <td rowspan="3">Time</td> <td>X</td> <td rowspan="3">For 2 hours on each X, Y, and Z axis.</td> </tr> <tr> <td>Y</td> </tr> <tr> <td>Z</td> </tr> </table> Recovery : At least 2hrs of recovery under the standard condition after the test, followed by the measurement within 48hrs.	Frequency Range	10~55Hz		Total Amplitude	1.5mm (May not exceed acceleration 196m/s ²)		Sweeping Method	10Hz to 55Hz to 10Hz for 1min.		Time	X	For 2 hours on each X, Y, and Z axis.	Y	Z
Frequency Range	10~55Hz														
Total Amplitude	1.5mm (May not exceed acceleration 196m/s ²)														
Sweeping Method	10Hz to 55Hz to 10Hz for 1min.														
Time	X	For 2 hours on each X, Y, and Z axis.													
	Y														
	Z														

14. Solderability					
Specified Value	NR30/40/50/60/80, NRV20/30, NRH24/30, NRS20/40/50/60/80 Type	At least 90% of surface of terminal electrode is covered by new solder.			
	NR10050 Type				
	NS101, NS125 Type				
Test Methods and Remarks	The test samples shall be dipped in flux, and then immersed in molten solder as shown in below table. Flux : Methanol solution containing rosin 25%. NR30/40/50/60/80, NRV20/30, NRH24/30, NRS20/40/50/60/80 Type, NR10050 Type, NS101/125 Type				
	<table border="1" data-bbox="279 1697 699 1758"> <tr> <td>Solder Temperature</td> <td>245\pm5$^{\circ}$C</td> </tr> <tr> <td>Time</td> <td>5\pm1.0 sec.</td> </tr> </table> ※Immersion depth : All sides of mounting terminal shall be immersed.	Solder Temperature	245 \pm 5 $^{\circ}$ C	Time	5 \pm 1.0 sec.
Solder Temperature	245 \pm 5 $^{\circ}$ C				
Time	5 \pm 1.0 sec.				

▶ This catalog contains the typical specification only due to the limitation of space. When you consider the purchase of our products, please check our specification.
For details of each product (characteristics graph, reliability information, precautions for use, and so on), see our Web site (<http://www.ty-top.com/>).

15. Resistance to soldering heat		
Specified Value	NR30/40/50/60/80, NRV20/30, NRH24/30, NRS20/40/50/60/80 Type	Inductance change : Within $\pm 10\%$ No significant abnormality in appearance.
	NR10050 Type	
	NS101, NS125 Type	
Test Methods and Remarks	NR30/40/50/60/80, NRV20/30, NRH24/30, NRS20/40/50/60/80 Type, NR10050 Type, NS101/125 Type : The test sample shall be exposed to reflow oven at $230\pm 5^{\circ}\text{C}$ for 40 seconds, with peak temperature at $260\pm 5^{\circ}\text{C}$ for 5 seconds, 2 times. NR30/40/50/60/80, NRV20/30, NRH24/30, NRS20/40/50/60/80 Type, NS101/125 Type Test board material : Glass epoxy-resin Test board thickness : 1.0mm NR10050 Type Test board material : Glass epoxy-resin Test board thickness : 1.6mm Recovery : At least 2hrs of recovery under the standard condition after the test, followed by the measurement within 48hrs.	

16. Thermal shock																				
Specified Value	NR30/40/50/60/80, NRV20/30, NRH24/30, NRS20/40/50/60/80 Type	Inductance change : Within $\pm 10\%$ No significant abnormality in appearance.																		
	NR10050 Type																			
	NS101, NS125 Type																			
Test Methods and Remarks	NR30/40/50/60/80, NRV20/30, NRH24/30, NRS20/40/50/60/80 Type, NR10050 Type, NS101/125 Type : The test samples shall be soldered to the test board by the reflow. The test samples shall be placed at specified temperature for specified time by step 1 to step 4 as shown in below table in sequence. The temperature cycle shall be repeated 100 cycles. <table border="1" style="margin: 10px auto;"> <thead> <tr> <th colspan="3">Conditions of 1 cycle</th> </tr> <tr> <th>Step</th> <th>Temperature ($^{\circ}\text{C}$)</th> <th>Duration (min)</th> </tr> </thead> <tbody> <tr> <td>1</td> <td>-40 ± 3</td> <td>30 ± 3</td> </tr> <tr> <td>2</td> <td>Room temperature</td> <td>Within 3</td> </tr> <tr> <td>3</td> <td>$+85\pm 2$</td> <td>30 ± 3</td> </tr> <tr> <td>4</td> <td>Room temperature</td> <td>Within 3</td> </tr> </tbody> </table> Recovery : At least 2hrs of recovery under the standard condition after the test, followed by the measurement within 48hrs.		Conditions of 1 cycle			Step	Temperature ($^{\circ}\text{C}$)	Duration (min)	1	-40 ± 3	30 ± 3	2	Room temperature	Within 3	3	$+85\pm 2$	30 ± 3	4	Room temperature	Within 3
Conditions of 1 cycle																				
Step	Temperature ($^{\circ}\text{C}$)	Duration (min)																		
1	-40 ± 3	30 ± 3																		
2	Room temperature	Within 3																		
3	$+85\pm 2$	30 ± 3																		
4	Room temperature	Within 3																		

17. Damp heat								
Specified Value	NR30/40/50/60/80, NRV20/30, NRH24/30, NRS20/40/50/60/80 Type	Inductance change : Within $\pm 10\%$ No significant abnormality in appearance.						
	NR10050 Type		—					
	NS101, NS125 Type	Inductance change : Within $\pm 10\%$ No significant abnormality in appearance.						
Test Methods and Remarks	NR30/40/50/60/80, NRV20/30, NRH24/30, NRS20/40/50/60/80 Type, NS101/125 Type : The test samples shall be soldered to the test board by the reflow. The test samples shall be placed in thermostatic oven set at specified temperature and humidity as shown in below table. <table border="1" style="margin: 10px auto;"> <tbody> <tr> <td>Temperature</td> <td>$60\pm 2^{\circ}\text{C}$</td> </tr> <tr> <td>Humidity</td> <td>90~95%RH</td> </tr> <tr> <td>Time</td> <td>500+24/-0 hour</td> </tr> </tbody> </table> Recovery : At least 2hrs of recovery under the standard condition after the test, followed by the measurement within 48hrs.		Temperature	$60\pm 2^{\circ}\text{C}$	Humidity	90~95%RH	Time	500+24/-0 hour
Temperature	$60\pm 2^{\circ}\text{C}$							
Humidity	90~95%RH							
Time	500+24/-0 hour							

18. Loading under damp heat										
Specified Value	NR30/40/50/60/80, NRV20/30, NRH24/30, NRS20/40/50/60/80 Type	Inductance change : Within $\pm 10\%$ No significant abnormality in appearance.								
	NR10050 Type									
	NS101, NS125 Type									
Test Methods and Remarks	NR30/40/50/60/80, NRV20/30, NRH24/30, NRS20/40/50/60/80 Type, NR10050 Type, NS101/125 Type : The test samples shall be soldered to the test board by the reflow. The test samples shall be placed in thermostatic oven set at specified temperature and humidity and applied the rated current continuously as shown in below table. <table border="1" style="margin: 10px auto;"> <tbody> <tr> <td>Temperature</td> <td>$60\pm 2^{\circ}\text{C}$</td> </tr> <tr> <td>Humidity</td> <td>90~95%RH</td> </tr> <tr> <td>Applied current</td> <td>Rated current</td> </tr> <tr> <td>Time</td> <td>500+24/-0 hour</td> </tr> </tbody> </table> Recovery : At least 2hrs of recovery under the standard condition after the test, followed by the measurement within 48hrs.		Temperature	$60\pm 2^{\circ}\text{C}$	Humidity	90~95%RH	Applied current	Rated current	Time	500+24/-0 hour
Temperature	$60\pm 2^{\circ}\text{C}$									
Humidity	90~95%RH									
Applied current	Rated current									
Time	500+24/-0 hour									

▶ This catalog contains the typical specification only due to the limitation of space. When you consider the purchase of our products, please check our specification.
 For details of each product (characteristics graph, reliability information, precautions for use, and so on), see our Web site (<http://www.ty-top.com/>).

19. Low temperature life test		
Specified Value	NR30/40/50/60/80, NRV20/30, NRH24/30, NRS20/40/50/60/80 Type	Inductance change : Within $\pm 10\%$ No significant abnormality in appearance.
	NR10050 Type	
	NS101, NS125 Type	
Test Methods and Remarks	NR30/40/50/60/80, NRV20/30, NRH24/30, NRS20/40/50/60/80 Type, NR10050 Type, NS101/125 Type : The test samples shall be soldered to the test board by the reflow. After that, the test samples shall be placed at test conditions as shown in below table.	
	Temperature	$-40 \pm 2^{\circ}\text{C}$
	Time	$500 + 24 / - 0$ hour
Recovery : At least 2hrs of recovery under the standard condition after the test, followed by the measurement within 48hrs.		
20. High temperature life test		
Specified Value	NR30/40/50/60/80, NRV20/30, NRH24/30, NRS20/40/50/60/80 Type	—
	NR10050 Type	—
	NS101, NS125 Type	—
Test Methods and Remarks	NR10050 Type :	
	Temperature	$105 \pm 3^{\circ}\text{C}$
	Time	$500 + 24 / - 0$ hour
Recovery : At least 2hrs of recovery under the standard condition after the test, followed by the measurement within 48hrs.		
21. Loading at high temperature life test		
Specified Value	NR30/40/50/60/80, NRV20/30, NRH24/30, NRS20/40/50/60/80 Type	Inductance change : Within $\pm 10\%$ No significant abnormality in appearance.
	NR10050 Type	—
	NS101, NS125 Type	Inductance change : Within $\pm 10\%$ No significant abnormality in appearance.
Test Methods and Remarks	NR30/40/50/60/80, NRV30, NRH24/30, NRS40/50/60/80 Type, NS12555, NS12565, NS12575 Type : The test samples shall be soldered to the test board by the reflow soldering.	
	Temperature	$85 \pm 2^{\circ}\text{C}$
	Applied current	Rated current
Time	$500 + 24 / - 0$ hour	
Recovery : At least 2hrs of recovery under the standard condition after the test, followed by the measurement within 48hrs.		
22. Standard condition		
Specified Value	NR30/40/50/60/80, NRV20/30, NRH24/30, NRS20/40/50/60/80 Type	Standard test condition : Unless otherwise specified, temperature is $20 \pm 15^{\circ}\text{C}$ and $65 \pm 20\%$ of relative humidity. When there is any question concerning measurement result: In order to provide correlation data, the test shall be condition of $20 \pm 2^{\circ}\text{C}$ of temperature, $65 \pm 5\%$ relative humidity. Inductance is in accordance with our measured value.
	NR10050 Type	
	NS101, NS125 Type	

SMD POWER INDUCTORS (NR□, NS SERIES)

PRECAUTIONS

1. Circuit Design

Precautions

◆ Operating environment

- The products described in this specification are intended for use in general electronic equipment, (office supply equipment, telecommunications systems, measuring equipment, and household equipment). They are not intended for use in mission-critical equipment or systems requiring special quality and high reliability (traffic systems, safety equipment, aerospace systems, nuclear control systems and medical equipment including life-support systems,) where product failure might result in loss of life, injury or damage. For such uses, contact TAIYO YUDEN Sales Department in advance.

2. PCB Design

Precautions

◆ Land pattern design

- Please refer to a recommended land pattern.
- There is stress, which has been caused by distortion of a PCB, to the inductor.
(NR30/40/50/60/80, NRV20/30, NRH24/30, NRS20/30/40/50/60/80 Type)
- Please consider the arrangement of parts on a PCB. (NR30/40/50/60/80, NRV20/30, NRH24/30, NRS20/30/40/50/60/80 Type)

Technical considerations

◆ Land pattern design

Surface Mounting

- Mounting and soldering conditions should be checked beforehand.
- Applicable soldering process to this products is reflow soldering only.
- Please use the recommended land pattern shown as below. Electrical characteristics and the mounting ability of the product are being considered in the recommended land pattern. If a PCB is designed with other dimensions, defective soldering and stress to a product may occur due to misalignment. The performance of the product may not be brought out. If an adopted land pattern is different from the recommended land pattern, stress to the product will increase. It may cause cracks or defective electrical characteristics of the product. Please conduct validation completely before studying adoption of this product and please judge the pros and cons of adoption of this product with taking on responsibility.
(NR30/40/50/60/80, NRV20/30, NRH24/30, NRS20/30/40/50/60/80 Type)
- As coefficients of thermal expansion between an inductor and a PCB differs, cracks may occur on a ferrite core when thermal stress is applied to them after mounting an inductor. (Please refer to the drawings below.) Please conduct validation completely before studying adoption of this product and please judge the pros and cons of adoption of this product with taking on responsibility.
(NR30/40/50/60/80, NRV20/30, NRH24/30, NRS20/30/40/50/60/80 Type)



- SMD inductors should be located to minimize any possible mechanical stresses from board warp or deflection. When splitting the PCB board after mounting inductors and other components, care is required so as not to give any stresses of deflection or twisting to the board.
(NR30/40/50/60/80, NRV20/30, NRH24/30, NRS20/30/40/50/60/80 Type)



A product tends to undergo stress in order "A>C>B≡D".
Please consider the layouts of a product to minimize any stresses.

3. Considerations for automatic placement	
Precautions	<ul style="list-style-type: none"> ◆Adjustment of mounting machine <ol style="list-style-type: none"> 1. Excessive impact load should not be imposed on the products when mounting onto the PC boards. 2. Mounting and soldering conditions should be checked beforehand.
Technical considerations	<ul style="list-style-type: none"> ◆Adjustment of mounting machine <ol style="list-style-type: none"> 1. When installing products, care should be taken not to apply distortion stress as it may deform the products. 2. Stress may be applied to a product with a warp or a twist in handling of the product. Please conduct validation completely before studying adoption of this product and please judge the pros and cons of adoption of this product with taking on responsibility. (NR30/40/50/60/80, NRV20/30, NRH24/30, NRS20/30/40/50/60/80 Type) <div style="display: flex; justify-content: space-around; align-items: center;"> <div style="text-align: center;"> <p><Wrap></p>  </div> <div style="text-align: center;"> <p><Twist></p>  </div> </div>

4. Soldering	
Precautions	<ul style="list-style-type: none"> ◆Reflow soldering <ol style="list-style-type: none"> 1. Please contact any of our offices for a reflow soldering, and refer to the recommended condition specified. 2. The product shall be used reflow soldering only. 3. Please do not add any stress to a product until it returns in normal temperature after reflow soldering. ◆Lead free soldering <ol style="list-style-type: none"> 1. When using products with lead free soldering, we request to use them after confirming adhesion, temperature of resistance to soldering heat, soldering etc sufficiently. ◆Recommended conditions for using a soldering iron (NR10050 Type) <ul style="list-style-type: none"> • Put the soldering iron on the land-pattern. • Soldering iron's temperature – Below 350°C • Duration – 3 seconds or less • The soldering iron should not directly touch the inductor.
Technical considerations	<ul style="list-style-type: none"> ◆Reflow soldering <ol style="list-style-type: none"> 1. If products are used beyond the range of the recommended conditions, heat stresses may deform the products, and consequently degrade the reliability of the products. <ul style="list-style-type: none"> •NR30/40/50/60/80, NRV20/30, NRH24/30, NRS20/40/50/60/80 Type, NR10050 Type, NS101/125 Type <p>Recommended reflow condition (Pb free solder)</p> 

5. Cleaning	
Precautions	<ul style="list-style-type: none"> ◆Cleaning conditions <ol style="list-style-type: none"> 1. Washing by supersonic waves shall be avoided.
Technical considerations	<ul style="list-style-type: none"> ◆Cleaning conditions <ol style="list-style-type: none"> 1. If washed by supersonic waves, the products might be broken.

▶ This catalog contains the typical specification only due to the limitation of space. When you consider the purchase of our products, please check our specification. For details of each product (characteristics graph, reliability information, precautions for use, and so on), see our Web site (<http://www.ty-top.com/>)

6. Handling	
Precautions	<ul style="list-style-type: none"> ◆ Handling <ol style="list-style-type: none"> 1. Keep the product away from all magnets and magnetic objects. ◆ Breakaway PC boards (splitting along perforations) <ol style="list-style-type: none"> 1. When splitting the PC board after mounting product, care should be taken not to give any stresses of deflection or twisting to the board. 2. Board separation should not be done manually, but by using the appropriate devices. ◆ Mechanical considerations <ol style="list-style-type: none"> 1. Please do not give the product any excessive mechanical shocks. 2. Please do not add any shock and power to a product in transportation. ◆ Pick-up pressure <ol style="list-style-type: none"> 1. Please do not push to add any pressure to a winding part. Please do not give any shock and push into a ferrite core exposure part. ◆ Packing <ol style="list-style-type: none"> 1. Please avoid accumulation of a packing box as much as possible.
Technical considerations	<ul style="list-style-type: none"> ◆ Handling <ol style="list-style-type: none"> 1. There is a case that a characteristic varies with magnetic influence. ◆ Breakaway PC boards (splitting along perforations) <ol style="list-style-type: none"> 1. The position of the product on PCBs shall be carefully considered to minimize the stress caused from splitting of the PCBs. ◆ Mechanical considerations <ol style="list-style-type: none"> 1. There is a case to be damaged by a mechanical shock. 2. There is a case to be broken by the handling in transportation. ◆ Pick-up pressure <ol style="list-style-type: none"> 1. Damage and a characteristic can vary with an excessive shock or stress. ◆ Packing <ol style="list-style-type: none"> 1. If packing boxes are accumulated, that could cause a deformation on packing tapes or a damage on the products.
7. Storage conditions	
Precautions	<ul style="list-style-type: none"> ◆ Storage <ol style="list-style-type: none"> 1. To maintain the solderability of terminal electrodes and to keep the packing material in good condition, temperature and humidity in the storage area should be controlled. <ul style="list-style-type: none"> ▪ Recommended conditions <ul style="list-style-type: none"> Ambient temperature : $-5\sim 40^{\circ}\text{C}$ Humidity : Below 70% RH ▪ The ambient temperature must be kept below 30°C. Even under ideal storage conditions, solderability of products electrodes may decrease as time passes. <p style="margin-left: 20px;">For this reason, product should be used within 6 months from the time of delivery. In case of storage over 6 months, solderability shall be checked before actual usage.</p>
Technical considerations	<ul style="list-style-type: none"> ◆ Storage <ol style="list-style-type: none"> 1. Under a high temperature and humidity environment, problems such as reduced solderability caused by oxidation of terminal electrodes and deterioration of taping/packaging materials may take place.

WIRE-WOUND CHIP POWER INDUCTORS(BR SERIES)



REFLOW

■ PARTS NUMBER

* Operating Temp.: -40~+105°C (Including self-generated heat)

B	R	△	L	2	5	1	8	T	2	R	2	M	△	△	△
①	②	③	④	⑤	⑥	⑦									

△=Blank space

①Series name

Code	Series name
BR	Wire-Wound chip power inductor

④Packaging

Code	Packaging
T	Taping

②Characteristics

Code	Characteristics
FL	Low profile
△L	
HL	
△C	High current

⑤Nominal inductance

Code (example)	Nominal inductance [μH]
R20	0.2
1R0	1.0
100	10
101	100

※R=Decimal point

③Dimensions (L × W)

Code	Type (inch)	Dimensions (L × W) [mm]
1608	1608(0603)	1.6 × 0.8
2012	2012(0805)	2.0 × 1.25
2016	2016(0806)	2.0 × 1.6
2518	2518(1007)	2.5 × 1.8
3225	3225(1210)	3.2 × 2.5

⑥Inductance tolerance

Code	Inductance tolerance
K	±10%
M	±20%

⑦Internal code

■ STANDARD EXTERNAL DIMENSIONS / STANDARD QUANTITY

Recommended Land Patterns
Surface Mounting

- Mounting and soldering conditions should be checked beforehand.
- Applicable soldering process to these products is reflow soldering only.

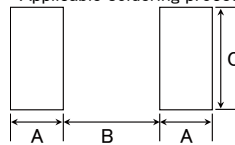
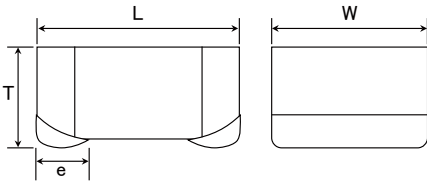

Type	A	B	C
1608	0.55	0.70	1.00
2012	0.60	1.00	1.45
2016	0.60	1.00	1.80
2518	0.60	1.50	2.00
3225	0.85	1.70	2.70

Unit: mm

Type	L	W	T	e	Standard quantity [pcs]	
					Paper tape	Embossed tape
BR L1608	1.6±0.2 (0.063±0.008)	0.8±0.2 (0.031±0.008)	0.7 max (0.028 max)	0.45±0.15 (0.016±0.006)	—	3000
BR C1608	1.6±0.2 (0.063±0.008)	0.8±0.2 (0.031±0.008)	0.8±0.2 (0.031±0.008)	0.45±0.15 (0.016±0.006)	—	3000
BR L2012	2.0±0.2 (0.079±0.008)	1.25±0.2 (0.049±0.008)	1.0 max (0.040 max)	0.5±0.2 (0.020±0.008)	—	3000
BR C2012	2.0±0.2 (0.079±0.008)	1.25±0.2 (0.049±0.008)	1.4 max (0.056 max)	0.5±0.2 (0.020±0.008)	—	2000
BR C2016	2.0±0.2 (0.079±0.008)	1.6±0.2 (0.063±0.008)	1.6±0.2 (0.063±0.008)	0.5±0.2 (0.020±0.008)	—	2000
BRFL2518	2.5±0.2 (0.098±0.008)	1.8±0.2 (0.071±0.008)	1.0 max (0.040 max)	0.5±0.2 (0.020±0.008)	—	3000
BR L2518	2.5±0.2 (0.098±0.008)	1.8±0.2 (0.071±0.008)	1.2 max (0.048 max)	0.5±0.2 (0.020±0.008)	—	3000
BRHL2518	2.5±0.2 (0.098±0.008)	1.8±0.2 (0.071±0.008)	1.5 max (0.060 max)	0.5±0.2 (0.020±0.008)	—	2000
BR C2518	2.5±0.2 (0.098±0.008)	1.8±0.2 (0.071±0.008)	1.8±0.2 (0.071±0.008)	0.5±0.2 (0.020±0.008)	—	2000
BR L3225	3.2±0.2 (0.126±0.008)	2.5±0.2 (0.098±0.008)	1.7 max (0.068 max)	0.75±0.2 (0.03±0.008)	—	2000

Unit: mm (inch)

▶ This catalog contains the typical specification only due to the limitation of space. When you consider the purchase of our products, please check our product specification sheets. For details of each product (characteristics graph, reliability information, precautions for use, and so on), see our website (<http://www.ty-top.com/>).

PARTS NUMBER

1608 (0603) type

Parts number	EHS	Nominal inductance [μ H]	Inductance tolerance	Self-resonant frequency [MHz] (min.)	DC Resistance [Ω] ($\pm 30\%$)	Rated current ※) [mA]		Measuring frequency [MHz]
						Saturation current Idc1	Temperature rise current Idc2	
BR L1608T1R0M	RoHS	1.0	$\pm 20\%$	700	0.230	510	650	1.0
BR L1608T1R5M	RoHS	1.5	$\pm 20\%$	600	0.280	440	590	1.0
BR L1608T2R2M	RoHS	2.2	$\pm 20\%$	400	0.400	360	500	1.0
BR L1608T3R3M	RoHS	3.3	$\pm 20\%$	300	0.650	290	390	1.0
BR L1608T4R7M	RoHS	4.7	$\pm 20\%$	150	1.00	240	310	1.0
BR L1608T6R8M	RoHS	6.8	$\pm 20\%$	100	1.64	200	250	1.0
BR L1608T100M	RoHS	10	$\pm 20\%$	45	2.00	170	220	1.0
BR L1608T150M	RoHS	15	$\pm 20\%$	32	2.56	150	200	1.0

Parts number	EHS	Nominal inductance [μ H]	Inductance tolerance	Self-resonant frequency [MHz] (min.)	DC Resistance [Ω] ($\pm 30\%$)	Rated current ※) [mA]		Measuring frequency [MHz]
						Saturation current Idc1	Temperature rise current Idc2	
BR C1608TR43M 6	RoHS	0.43	$\pm 20\%$	740	0.082	1,400	1,100	6.0
BR C1608TR50M 6	RoHS	0.50	$\pm 20\%$	710	0.090	1,200	1,050	6.0
BR C1608TR60M 6	RoHS	0.60	$\pm 20\%$	630	0.099	1,100	940	6.0
BR C1608TR72M 6	RoHS	0.72	$\pm 20\%$	600	0.144	1,000	810	6.0
BR C1608TR82M 6	RoHS	0.82	$\pm 20\%$	560	0.176	950	730	6.0
BR C1608T1R0M 6	RoHS	1.0	$\pm 20\%$	550	0.188	890	680	6.0

Parts number	EHS	Nominal inductance [μ H]	Inductance tolerance	Self-resonant frequency [MHz] (min.)	DC Resistance [Ω] ($\pm 30\%$)	Rated current ※) [mA]		Measuring frequency [MHz]
						Saturation current Idc1	Temperature rise current Idc2	
BR C1608TR20M	RoHS	0.20	$\pm 20\%$	400	0.060	1,750	980	7.96
BR C1608TR35M	RoHS	0.35	$\pm 20\%$	300	0.080	1,400	810	7.96
BR C1608TR45M	RoHS	0.45	$\pm 20\%$	200	0.090	1,250	800	7.96
BR C1608TR56M	RoHS	0.56	$\pm 20\%$	170	0.095	1,150	760	7.96
BR C1608TR77M	RoHS	0.77	$\pm 20\%$	150	0.110	1,000	660	7.96
BR C1608T1R0M	RoHS	1.0	$\pm 20\%$	140	0.180	850	520	7.96
BR C1608T1R5M	RoHS	1.5	$\pm 20\%$	120	0.300	700	410	7.96
BR C1608T2R2M	RoHS	2.2	$\pm 20\%$	100	0.550	550	280	7.96

2012 (0805) type

Parts number	EHS	Nominal inductance [μ H]	Inductance tolerance	Self-resonant frequency [MHz] (min.)	DC Resistance [Ω] ($\pm 30\%$)	Rated current ※) [mA]		Measuring frequency [MHz]
						Saturation current Idc1	Temperature rise current Idc2	
BR L2012TR47M 6	RoHS	0.47	$\pm 20\%$	500	0.048	1,500	1,900	6.0
BR L2012T1R0M 6	RoHS	1.0	$\pm 20\%$	400	0.108	1,050	1,230	6.0
BR L2012T2R2MD6	RoHS	2.2	$\pm 20\%$	250	0.184	680	950	6.0

Parts number	EHS	Nominal inductance [μ H]	Inductance tolerance	Self-resonant frequency [MHz] (min.)	DC Resistance [Ω] ($\pm 30\%$)	Rated current ※) [mA]		Measuring frequency [MHz]
						Saturation current Idc1	Temperature rise current Idc2	
BR L2012TR47M	RoHS	0.47	$\pm 20\%$	350	0.090	1,100	1,050	7.96
BR L2012T1R0M	RoHS	1.0	$\pm 20\%$	300	0.135	850	850	7.96
BR L2012T1R5M	RoHS	1.5	$\pm 20\%$	250	0.180	700	750	7.96
BR L2012T2R2M	RoHS	2.2	$\pm 20\%$	200	0.300	600	550	7.96
BR L2012T3R3M	RoHS	3.3	$\pm 20\%$	190	0.500	490	440	7.96
BR L2012T4R7M	RoHS	4.7	$\pm 20\%$	150	0.550	340	400	7.96
BR L2012T6R8M	RoHS	6.8	$\pm 20\%$	60	0.750	290	350	7.96
BR L2012T100M	RoHS	10	$\pm 20\%$	30	0.850	270	330	2.52
BR L2012T150M	RoHS	15	$\pm 20\%$	15	1.00	220	300	2.52
BR L2012T220M	RoHS	22	$\pm 20\%$	13	1.30	190	270	2.52
BR L2012T330M	RoHS	33	$\pm 20\%$	8.0	2.00	150	220	2.52
BR L2012T470M	RoHS	47	$\pm 20\%$	7.0	3.50	125	160	2.52
BR L2012T680M	RoHS	68	$\pm 20\%$	6.5	5.80	100	110	2.52
BR L2012T101M	RoHS	100	$\pm 20\%$	6.0	7.70	85	85	0.796

Parts number	EHS	Nominal inductance [μ H]	Inductance tolerance	Self-resonant frequency [MHz] (min.)	DC Resistance [Ω] ($\pm 30\%$)	Rated current ※) [mA]		Measuring frequency [MHz]
						Saturation current Idc1	Temperature rise current Idc2	
BR C2012T1R0M	RoHS	1.0	$\pm 20\%$	490	0.060	1,500	1,400	1.0
BR C2012T1R5MD	RoHS	1.5	$\pm 20\%$	390	0.090	1,200	1,100	1.0
BR C2012T2R2MD	RoHS	2.2	$\pm 20\%$	350	0.110	1,100	1,000	1.0
BR C2012T3R3MD	RoHS	3.3	$\pm 20\%$	300	0.170	800	870	1.0
BR C2012T4R7MD	RoHS	4.7	$\pm 20\%$	250	0.265	700	600	1.0

※) The saturation current value (Idc1) is the DC current value having inductance decrease down to 30%. (at 20°C)
 ※) The temperature rise current value (Idc2) is the DC current value having temperature increase by 40°C. (at 20°C)
 ※) The rated current value is following either Idc1 or Idc2, which is the lower one.

► This catalog contains the typical specification only due to the limitation of space. When you consider the purchase of our products, please check our product specification sheets. For details of each product (characteristics graph, reliability information, precautions for use, and so on), see our website (<http://www.ty-top.com/>).

■ PARTS NUMBER

● 2016 (0806) type

Parts number	EHS	Nominal inductance [μ H]	Inductance tolerance	Self-resonant frequency [MHz] (min.)	DC Resistance [Ω] (\pm 30%)	Rated current ※) [mA]		Measuring frequency [MHz]
						Saturation current Idc1	Temperature rise current Idc2	
BR C2016T1R0M	RoHS	1.0	\pm 20%	450	0.085	1,350	1,100	0.10
BR C2016T1R5M	RoHS	1.5	\pm 20%	370	0.150	1,100	820	0.10
BR C2016T2R2M	RoHS	2.2	\pm 20%	250	0.180	910	760	0.10
BR C2016T3R3M	RoHS	3.3	\pm 20%	140	0.220	740	680	0.10
BR C2016T4R7M	RoHS	4.7	\pm 20%	78	0.270	660	610	0.10
BR C2016T6R8M	RoHS	6.8	\pm 20%	39	0.330	550	560	0.10
BR C2016T100□	RoHS	10	\pm 10%, \pm 20%	35	0.400	450	520	0.10
BR C2016T150□	RoHS	15	\pm 10%, \pm 20%	28	0.600	400	410	0.10
BR C2016T220□	RoHS	22	\pm 10%, \pm 20%	24	1.00	310	310	0.10
BR C2016T330□	RoHS	33	\pm 10%, \pm 20%	13	1.70	270	240	0.10
BR C2016T470□	RoHS	47	\pm 10%, \pm 20%	11	2.20	210	210	0.10
BR C2016T680□	RoHS	68	\pm 10%, \pm 20%	8	2.80	200	190	0.10
BR C2016T101□	RoHS	100	\pm 10%, \pm 20%	7	3.40	140	170	0.10

● 2518 (1007) type

Parts number	EHS	Nominal inductance [μ H]	Inductance tolerance	Self-resonant frequency [MHz] (min.)	DC Resistance [Ω] (\pm 30%)	Rated current ※) [mA]		Measuring frequency [MHz]
						Saturation current Idc1	Temperature rise current Idc2	
BRFL2518T1R0M	RoHS	1.0	\pm 20%	130	0.090	1,200	1,200	1.0
BRFL2518T1R5M	RoHS	1.5	\pm 20%	100	0.110	1,100	1,000	1.0
BRFL2518T2R2M	RoHS	2.2	\pm 20%	80	0.130	850	950	1.0
BRFL2518T3R3M	RoHS	3.3	\pm 20%	70	0.220	700	700	1.0
BRFL2518T4R7M	RoHS	4.7	\pm 20%	60	0.330	650	650	1.0

Parts number	EHS	Nominal inductance [μ H]	Inductance tolerance	Self-resonant frequency [MHz] (min.)	DC Resistance [Ω] (\pm 30%)	Rated current ※) [mA]		Measuring frequency [MHz]
						Saturation current Idc1	Temperature rise current Idc2	
BR L2518T1R0M	RoHS	1.0	\pm 20%	130	0.080	1,600	1,000	7.96
BR L2518T1R5M	RoHS	1.5	\pm 20%	100	0.100	1,200	920	7.96
BR L2518T2R2M	RoHS	2.2	\pm 20%	80	0.135	1,000	850	7.96
BR L2518T3R3M	RoHS	3.3	\pm 20%	70	0.300	800	580	7.96
BR L2518T4R7M	RoHS	4.7	\pm 20%	60	0.400	700	470	7.96

Parts number	EHS	Nominal inductance [μ H]	Inductance tolerance	Self-resonant frequency [MHz] (min.)	DC Resistance [Ω] (\pm 30%)	Rated current ※) [mA]		Measuring frequency [MHz]
						Saturation current Idc1	Temperature rise current Idc2	
BRHL2518T1R0M	RoHS	1.0	\pm 20%	400	0.055	2,000	1,400	1.0
BRHL2518T1R5M	RoHS	1.5	\pm 20%	350	0.085	1,700	1,100	1.0
BRHL2518T2R2M	RoHS	2.2	\pm 20%	300	0.115	1,500	1,000	1.0
BRHL2518T3R3MD	RoHS	3.3	\pm 20%	200	0.165	1,200	800	1.0
BRHL2518T4R7MD	RoHS	4.7	\pm 20%	150	0.245	1,100	750	1.0

Parts number	EHS	Nominal inductance [μ H]	Inductance tolerance	Self-resonant frequency [MHz] (min.)	DC Resistance [Ω] (\pm 30%)	Rated current ※) [mA]		Measuring frequency [MHz]
						Saturation current Idc1	Temperature rise current Idc2	
BR C2518T1R0M	RoHS	1.0	\pm 20%	280	0.050	2,550	1,650	1.0
BR C2518T1R5M	RoHS	1.5	\pm 20%	230	0.080	2,100	1,300	1.0
BR C2518T2R2M	RoHS	2.2	\pm 20%	200	0.120	1,800	1,000	1.0
BR C2518T3R3M	RoHS	3.3	\pm 20%	150	0.175	1,450	860	1.0
BR C2518T4R7M	RoHS	4.7	\pm 20%	100	0.230	1,250	750	1.0
BR C2518T6R8M	RoHS	6.8	\pm 20%	45	0.280	1,050	680	1.0
BR C2518T100□	RoHS	10	\pm 10%, \pm 20%	20	0.350	890	610	1.0
BR C2518T150□	RoHS	15	\pm 10%, \pm 20%	13	0.430	760	550	1.0
BR C2518T220□	RoHS	22	\pm 10%, \pm 20%	10	0.560	640	490	1.0
BR C2518T330□	RoHS	33	\pm 10%, \pm 20%	8	0.850	560	390	1.0
BR C2518T470□	RoHS	47	\pm 10%, \pm 20%	6.5	1.45	410	300	1.0
BR C2518T680□	RoHS	68	\pm 10%, \pm 20%	5.5	2.40	340	230	1.0
BR C2518T101□	RoHS	100	\pm 10%, \pm 20%	4.5	3.60	300	190	1.0

□ Please specify the inductance tolerance code. (M or K)

※) The saturation current value (Idc1) is the DC current value having inductance decrease down to 30%. (at 20°C)

※) The temperature rise current value (Idc2) is the DC current value having temperature increase by 40°C. (at 20°C)

※) The rated current value is following either Idc1 or Idc2, which is the lower one.

PARTS NUMBER

● 3225 (1210) type

Parts number	EHS	Nominal inductance [μ H]	Inductance tolerance	Self-resonant frequency [MHz] (min.)	DC Resistance [Ω] ($\pm 30\%$)	Rated current ※) [mA]		Measuring frequency [MHz]
						Saturation current Idc1	Temperature rise current Idc2	
BR L3225TR27M	RoHS	0.27	$\pm 20\%$	390	0.022	4,500	2,850	7.96
BR L3225TR36M	RoHS	0.36	$\pm 20\%$	350	0.025	4,300	2,750	7.96
BR L3225TR51M	RoHS	0.51	$\pm 20\%$	270	0.029	3,600	2,550	7.96

Parts number	EHS	Nominal inductance [μ H]	Inductance tolerance	Self-resonant frequency [MHz] (min.)	DC Resistance [Ω] ($\pm 20\%$)	Rated current ※) [mA]		Measuring frequency [MHz]
						Saturation current Idc1	Temperature rise current Idc2	
BR L3225T1R0M	RoHS	1.0	$\pm 20\%$	220	0.043	2,400	2,200	0.1
BR L3225T1R5M	RoHS	1.5	$\pm 20\%$	170	0.045	2,200	1,750	0.1
BR L3225T2R2M	RoHS	2.2	$\pm 20\%$	150	0.065	1,850	1,600	0.1
BR L3225T3R3M	RoHS	3.3	$\pm 20\%$	140	0.120	1,450	1,200	0.1
BR L3225T4R7M	RoHS	4.7	$\pm 20\%$	120	0.180	1,300	1,000	0.1
BR L3225T6R8M	RoHS	6.8	$\pm 20\%$	90	0.270	1,050	770	0.1
BR L3225T100□	RoHS	10	$\pm 10\%$, $\pm 20\%$	70	0.350	900	700	0.1
BR L3225T150□	RoHS	15	$\pm 10\%$, $\pm 20\%$	20	0.570	700	530	0.1
BR L3225T220□	RoHS	22	$\pm 10\%$, $\pm 20\%$	13	0.690	550	470	0.1
BR L3225T330□	RoHS	33	$\pm 10\%$, $\pm 20\%$	9	0.840	470	420	0.1
BR L3225T470□	RoHS	47	$\pm 10\%$, $\pm 20\%$	7	1.00	420	390	0.1
BR L3225T680□	RoHS	68	$\pm 10\%$, $\pm 20\%$	6	1.40	330	300	0.1
BR L3225T101□	RoHS	100	$\pm 10\%$, $\pm 20\%$	5	2.50	270	250	0.1

□ Please specify the inductance tolerance code. (M or K)

※) The saturation current value (Idc1) is the DC current value having inductance decrease down to 30%. (at 20°C)

※) The temperature rise current value (Idc2) is the DC current value having temperature increase by 40°C. (at 20°C)

※) The rated current value is following either Idc1 or Idc2, which is the lower one.

WIRE-WOUND CHIP POWER INDUCTORS (BR SERIES)

PACKAGING

① Minimum Quantity

Type	Standard Quantity [pcs]	
	Paper Tape	Embossed Tape
BR C1608	—	3,000
BR L1608	—	3,000
BR L2012	—	3,000
BR C2012	—	2,000
BR C2016	—	2,000
BR C2518	—	2,000
BRHL2518	—	2,000
BR L2518	—	3,000
BRFL2518	—	3,000
BR L3225	—	2,000

② Tape Material

● Embossed tape

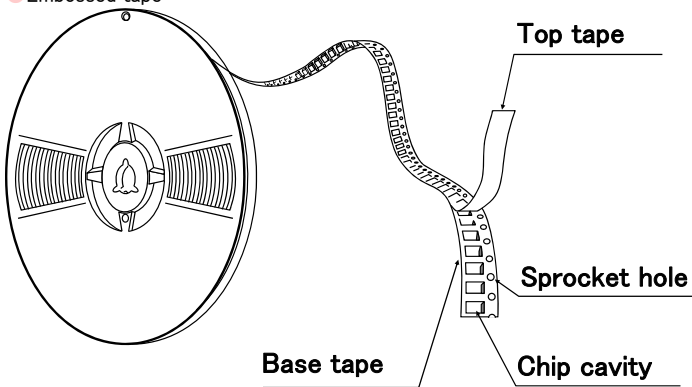

Chip Filled

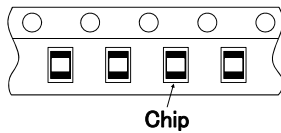

③ Taping dimensions

● Embossed Tape 8mm wide (0.315 inches wide)

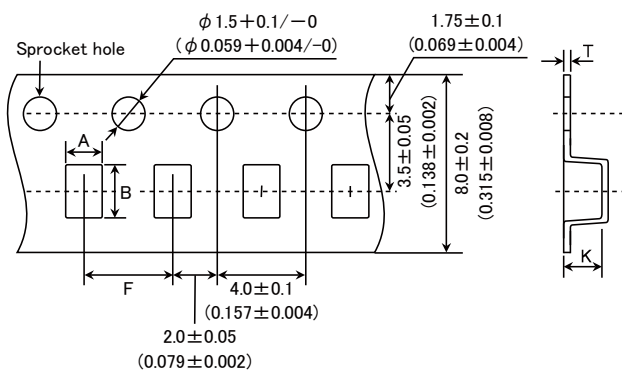

▶ This catalog contains the typical specification only due to the limitation of space. When you consider the purchase of our products, please check our specification. For details of each product (characteristics graph, reliability information, precautions for use, and so on), see our Web site (<http://www.ty-top.com/>).

Type	Chip cavity		Insertion pitch	Tape thickness	
	A	B	F	T	K
BR L1608	1.1±0.1 (0.043±0.004)	1.9±0.1 (0.075±0.004)	4.0±0.1 (0.157±0.004)	0.2±0.05 (0.008±0.002)	0.9 max (0.035 max)
BR C1608	1.1±0.1 (0.043±0.004)	1.9±0.1 (0.075±0.004)	4.0±0.1 (0.157±0.004)	0.25±0.05 (0.010±0.002)	1.2 max (0.047 max)
BR L2012	1.45±0.1 (0.057±0.004)	2.2±0.1 (0.087±0.004)	4.0±0.1 (0.157±0.004)	0.25±0.05 (0.010±0.002)	1.2 max (0.047 max)
BR C2012	1.45±0.1 (0.057±0.004)	2.37±0.1 (0.093±0.004)	4.0±0.1 (0.157±0.004)	0.25±0.05 (0.010±0.002)	1.59 max (0.063 max)
BR C2016	1.75±0.1 (0.069±0.004)	2.1±0.1 (0.083±0.004)	4.0±0.1 (0.157±0.004)	0.3±0.05 (0.012±0.002)	1.9 max (0.075 max)
BRFL2518	2.3±0.1 (0.091±0.004)	2.8±0.1 (0.110±0.004)	4.0±0.1 (0.157±0.004)	0.25±0.05 (0.010±0.002)	1.3 max (0.051 max)
BR L2518	2.3±0.1 (0.091±0.004)	2.8±0.1 (0.110±0.004)	4.0±0.1 (0.157±0.004)	0.3±0.05 (0.012±0.002)	1.45 max (0.057 max)
BRHL2518	2.1±0.1 (0.083±0.004)	2.8±0.1 (0.110±0.004)	4.0±0.1 (0.157±0.004)	0.3±0.05 (0.012±0.002)	1.7 max (0.067 max)
BR C2518	2.15±0.1 (0.085±0.004)	2.7±0.1 (0.106±0.004)	4.0±0.1 (0.157±0.004)	0.3±0.05 (0.012±0.002)	2.2 max (0.087 max)
BR L3225	2.8±0.1 (0.110±0.004)	3.5±0.1 (0.138±0.004)	4.0±0.1 (0.157±0.004)	0.25±0.05 (0.010±0.002)	1.9 max (0.075 max)

Unit: mm (inch)

④ Leader and Blank portion

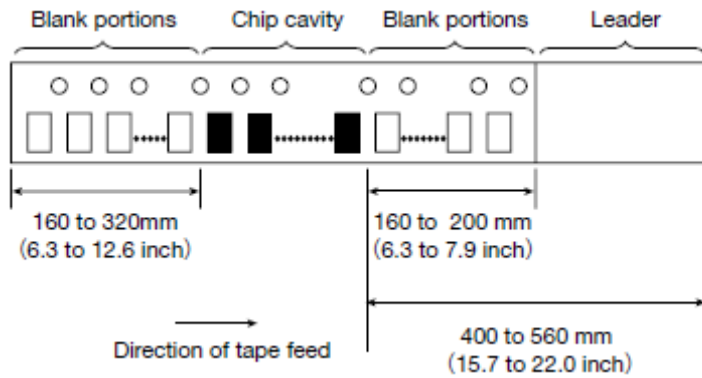

⑤ Reel size

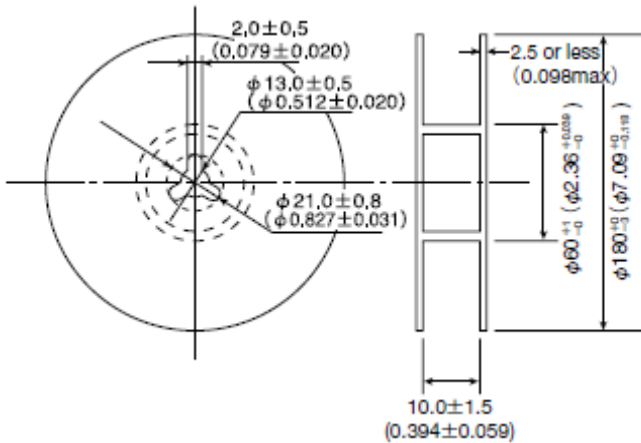

⑥ Top Tape Strength

The top tape requires a peel-off force of 0.2 to 0.7N in the direction of the arrow as illustrated below.

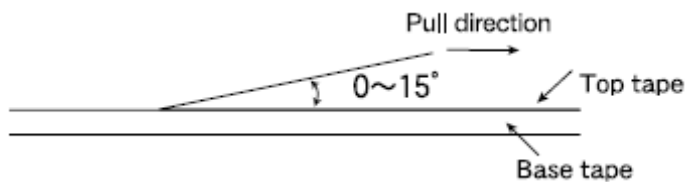

WIRE-WOUND CHIP POWER INDUCTORS (BR SERIES)

RELIABILITY DATA

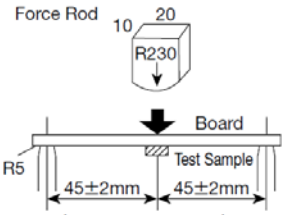
1. Operating Temperature Range		
Specified Value	BR series	-40~+105°C
Test Methods and Remarks	Including self-generated heat	
2. Storage Temperature Range (after soldering)		
Specified Value	BR series	-40~+85°C
Test Methods and Remarks	Please refer the term of "7.Storage conditions" in Precautions.	
3. Rated current		
Specified Value	BR series	Within the specified tolerance
4. Inductance		
Specified Value	BR series	Within the specified tolerance
Test Methods and Remarks	Measuring equipment : LCR Meter (HP 4285A or equivalent) Measuring frequency : Specified frequency	
5. DC Resistance		
Specified Value	BR series	Within the specified tolerance
Test Methods and Remarks	Measuring equipment : DC ohmmeter (HIOKI 3227 or equivalent)	
6. Self resonance frequency		
Specified Value	BR series	Within the specified tolerance
Test Methods and Remarks	Measuring equipment : Impedance analyzer/material analyzer (HP4291A or equivalent HP4191A, 4192A or equivalent)	
7. Temperature characteristic		
Specified Value	BR series	Inductance change : Within $\pm 15\%$
Test Methods and Remarks	Based on the inductance at 20°C and Measured at the ambient of -40°C~+85°C.	
8. Resistance to the bendability		
Specified Value	BR series	No damage.
Test Methods and Remarks	The given sample is soldered on the board and then the back side of the board is pushed until it bends 2mm like the figure. Dimension of the board : 100×40×1.0mm (0.8mm thickness for 1608(0603) inductors) Material of the board : Glass epoxy-resin Thickness of soldering paste : 0.12mm 	

▶ This catalog contains the typical specification only due to the limitation of space. When you consider the purchase of our products, please check our specification. For details of each product (characteristics graph, reliability information, precautions for use, and so on), see our Web site (<http://www.ty-top.com/>).

9. Body strength		
Specified Value	BR series	No damage.
Test Methods and Remarks	2012~ Applied orce : 10N Duration : 10sec. 1608 size Applied force : 5N Duration : 10sec.	

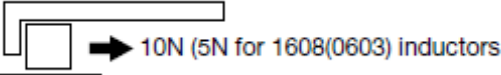
10. Adhesion of terminal electrodes		
Specified Value	BR series	Not to removed from the board.
Test Methods and Remarks	The given sample is soldered to the board and then it is kept for 5sec with 10N stress (5N for 1608(0603) inductors) like the figure. 	

11. Resistance to vibration																
Specified Value	BR series	Inductance change : Within $\pm 10\%$ No significant abnormality in appearance.														
Test Methods and Remarks	The given sample is soldered to the board and then it is tested depending on the conditions of the following table. <table border="1" data-bbox="279 728 1157 907"> <tr> <td>Vibration Frequency</td> <td colspan="2">10~55Hz</td> </tr> <tr> <td>Total Amplitude</td> <td colspan="2">1.5mm (May not exceed acceleration 196m/s²)</td> </tr> <tr> <td>Sweeping Method</td> <td colspan="2">10Hz to 55Hz to 10Hz for 1min.</td> </tr> <tr> <td rowspan="3">Time</td> <td>X</td> <td rowspan="3">For 2 hours on each X, Y, and Z axis.</td> </tr> <tr> <td>Y</td> </tr> <tr> <td>Z</td> </tr> </table> Recovery : At least 2hrs of recovery under the standard condition after the test, followed by the measurement within 48hrs.		Vibration Frequency	10~55Hz		Total Amplitude	1.5mm (May not exceed acceleration 196m/s ²)		Sweeping Method	10Hz to 55Hz to 10Hz for 1min.		Time	X	For 2 hours on each X, Y, and Z axis.	Y	Z
Vibration Frequency	10~55Hz															
Total Amplitude	1.5mm (May not exceed acceleration 196m/s ²)															
Sweeping Method	10Hz to 55Hz to 10Hz for 1min.															
Time	X	For 2 hours on each X, Y, and Z axis.														
	Y															
	Z															

12. Solderability						
Specified Value	BR series	At least 90% area of the electrodes is covered by new solder.				
Test Methods and Remarks	Test Method and Remarks】 The given sample is dipped into the flux and then it is tested depending on the conditions of the following table. Flux : Methanol solution containing rosin 25%. <table border="1" data-bbox="279 1131 702 1198"> <tr> <td>Solder Temperature</td> <td>245\pm5$^{\circ}$C</td> </tr> <tr> <td>Time</td> <td>5\pm0.5 sec.</td> </tr> </table>		Solder Temperature	245 \pm 5 $^{\circ}$ C	Time	5 \pm 0.5 sec.
Solder Temperature	245 \pm 5 $^{\circ}$ C					
Time	5 \pm 0.5 sec.					

13. Resistance to soldering heat		
Specified Value	BR series	Inductance change : Within $\pm 10\%$ No significant abnormality in appearance.
Test Methods and Remarks	3 times reflow having the temperature profile of 5sec of 260 \pm 0/ $-$ 5 $^{\circ}$ C and 40sec of more than 230 $^{\circ}$ C. Test board thickness : 1.0mm Test board material : Glass epoxy-resin Recovery : At least 2hrs of recovery under the standard condition after the test, followed by the measurement within 48hrs.	

14. Thermal shock																				
Specified Value	BR series	Inductance change : Within $\pm 10\%$ No significant abnormality in appearance.																		
Test Methods and Remarks	The given sample is soldered to the board and then its Inductance is measured after 100cycles of the following conditions. <table border="1" data-bbox="279 1624 885 1803"> <thead> <tr> <th colspan="3">Conditions of 1 cycle</th> </tr> <tr> <th>Step</th> <th>Temperature ($^{\circ}$C)</th> <th>Duration (min)</th> </tr> </thead> <tbody> <tr> <td>1</td> <td>-40\pm3</td> <td>30\pm3</td> </tr> <tr> <td>2</td> <td>Room temperature</td> <td>Within 3</td> </tr> <tr> <td>3</td> <td>+85\pm2</td> <td>30\pm3</td> </tr> <tr> <td>4</td> <td>Room temperature</td> <td>Within 3</td> </tr> </tbody> </table> Recovery : At least 2hrs of recovery under the standard condition after the test, followed by the measurement within 48 hrs.		Conditions of 1 cycle			Step	Temperature ($^{\circ}$ C)	Duration (min)	1	-40 \pm 3	30 \pm 3	2	Room temperature	Within 3	3	+85 \pm 2	30 \pm 3	4	Room temperature	Within 3
Conditions of 1 cycle																				
Step	Temperature ($^{\circ}$ C)	Duration (min)																		
1	-40 \pm 3	30 \pm 3																		
2	Room temperature	Within 3																		
3	+85 \pm 2	30 \pm 3																		
4	Room temperature	Within 3																		

▶ This catalog contains the typical specification only due to the limitation of space. When you consider the purchase of our products, please check our specification.
 For details of each product (characteristics graph, reliability information, precautions for use, and so on), see our Web site (<http://www.ty-top.com/>).

15. Damp heat		
Specified Value	BR series	Inductance change : Within $\pm 10\%$ No significant abnormality in appearance.
Test Methods and Remarks	The given sample is soldered to the board and then it is kept at the following conditions.	
	Temperature	$60 \pm 2^\circ\text{C}$
	Humidity	90~95%RH
	Time	1000 hours.
Recovery : At least 2hrs of recovery under the standard condition after the test, followed by the measurement within 48 hrs.		

16. Loading under damp heat		
Specified Value	BR series	Inductance change : Within $\pm 10\%$ No significant abnormality in appearance.
Test Methods and Remarks	The given sample is soldered to the board and then it is kept at the following conditions.	
	Temperature	$60 \pm 2^\circ\text{C}$
	Humidity	90~95%RH
	Applied current	Rated current
	Time	1000hours.
Recovery : At least 2hrs of recovery under the standard condition after the test, followed by the measurement within 48 hrs.		

17. Low temperature life test		
Specified Value	BR series	Inductance change : Within $\pm 10\%$ No significant abnormality in appearance.
Test Methods and Remarks	The given sample is soldered to the board and then it is kept at the following conditions.	
	Temperature	$-40 \pm 2^\circ\text{C}$
	Duration	1000hours
	Recovery : At least 2hrs of recovery under the standard condition after the test, followed by the measurement within 48 hrs.	

18. High temperature life test		
Specified Value	BR series	Inductance change : Within $\pm 10\%$ No significant abnormality in appearance.
Test Methods and Remarks	The given sample is soldered to the board and then it is kept at the following conditions.	
	Temperature	$85 \pm 2^\circ\text{C}$
	Duration	1000hours
	Recovery : At least 2hrs of recovery under the standard condition after the test, followed by the measurement within 48 hrs.	

19. Standard conditions		
Specified Value	BR series	Standard test condition : Unless otherwise specified, temperature is $20 \pm 15^\circ\text{C}$ and $65 \pm 20\%$ of relative humidity. When there is any question concerning measurement result: In order to provide correlation data, the test shall be condition of $20 \pm 2^\circ\text{C}$ of temperature, $65 \pm 5\%$ relative humidity. Inductance is in accordance with our measured value.

WIRE-WOUND CHIP POWER INDUCTORS(BR SERIES)

■ PRECAUTIONS

1. Circuit Design	
Precautions	<p>◆ Operating Ambient The products are premised on the usage for the general equipments like the office supply equipment, the telecommunications systems, the measuring equipment, the household equipment and so on. Please ask to TAIYO YUDEN's sales person in advance, if you need to apply them to the equipments or the systems which might have any influences for the human body, the property, like the traffic systems, the safety equipment, the aerospace systems, the nuclear control systems, the medical equipment and soon.</p>
2. PCB Design	
Precautions	<p>◆ Land pattern design 1. Please refer to a recommended land pattern.</p>
Technical considerations	<p>◆ Land pattern design Surface Mounting 1. The conditions of the picking and placing should be checked in advance. 2. The products are only for reflow soldering.</p>
3. Considerations for automatic placement	
Precautions	<p>◆ Adjustment of mounting machine 1. Excessive physical impact should not be imposed on the products for picking and placing onto the PC boards. 2. Mounting and soldering conditions should be checked in advance.</p>
Technical considerations	<p>◆ Adjustment of mounting machine The products might be broken if too much stress is given for the picking and placing.</p>
4. Soldering	
Precautions	<p>◆ Reflow soldering 1. Please apply our recommended soldering conditions on the specification as much as possible. 2. The products are only for reflow soldering. 3. Please do not give any stress to a product until it returns in room temperature after reflow soldering.</p> <p>◆ Recommended conditions for using a soldering iron. (Excluding 1608 type) Touch a soldering iron to the land pattern not to the product directly. The temperature of a soldering iron is less than 350degC. The soldering is for 3 seconds or less.</p>
Technical considerations	<p>◆ Reflow soldering 1. The product might break or might make the tombstoning, if the soldering conditions are too far from our recommended conditions.</p> <p>Temperature [°C]</p> <p>Heating Time [sec]</p> <p>150~180</p> <p>90±30sec</p> <p>30±10sec</p> <p>230°C min</p> <p>5sec max</p> <p>Peak: 260±0/-5°C</p>
5. Cleaning	
Precautions	<p>◆ Cleaning conditions 1. Please don't wash by the ultra-sonic waves.</p>
Technical considerations	<p>◆ Cleaning conditions 1. Washing by the ultra-sonic waves might break the product.</p>

6. Handling	
Precautions	<ul style="list-style-type: none"> ◆ Handling <ol style="list-style-type: none"> 1. Keep the product away from any magnets. ◆ Cutting the PC boards <ol style="list-style-type: none"> 1. Please don't give any stress of the bending or the twisting for the cutting process of PC boards. 2. Please don't give any shock and stress to the products in transportation. ◆ Mechanical considerations <ol style="list-style-type: none"> 1. Please don't give too much shock to the product. 2. Please don't give any shock and stress to the products in transportation. ◆ The stress for picking and placing <ol style="list-style-type: none"> 1. Please don't give any shock into an exposed ferrite core. ◆ Packing <ol style="list-style-type: none"> 1. Please don't pile the packing boxes up as much as possible.
Technical considerations	<ul style="list-style-type: none"> ◆ Handling <ol style="list-style-type: none"> 1. There is a case that a characteristic varies with magnetic influence. ◆ Cutting the PC boards <ol style="list-style-type: none"> 1. Please don't give the bending stress or the twisting stress to the products because they might break in such cases. ◆ Mechanical considerations <ol style="list-style-type: none"> 1. The mechanical shock might break the products. 2. The products might break depending on the handling in transportation. ◆ Pick-up pressure <ol style="list-style-type: none"> 1. The electrical characteristics of the products might be shifted by too much physical shock and stress. ◆ Packing <ol style="list-style-type: none"> 1. The products and the tape might break, if the packing boxes are piled up.
7. Storage conditions	
Precautions	<ul style="list-style-type: none"> ◆ Storage <ol style="list-style-type: none"> 1. To maintain the solderability of terminal electrodes and to keep the packing material in good condition, temperature and humidity in the storage area should be controlled. <ul style="list-style-type: none"> ▪ Recommended conditions <ul style="list-style-type: none"> Ambient temperature : 0~40°C Humidity : Below 70% RH ▪ The ambient temperature must be kept below 30°C. Even under ideal storage conditions, solderability of products electrodes may decrease as time passes. <ul style="list-style-type: none"> For this reason, product should be used within 6 months from the time of delivery. In case of storage over 6 months, solderability shall be checked before actual usage.
Technical considerations	<ul style="list-style-type: none"> ◆ Storage <ol style="list-style-type: none"> 1. The ambient of high temperature or high humidity might accelerate to make the solderability and the tape worse.

WIRE-WOUND CHIP POWER INDUCTORS (CB SERIES)

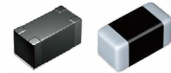

REFLOW

PARTS NUMBER

* Operating Temp.: -40~+105°C (Including self-generated heat)

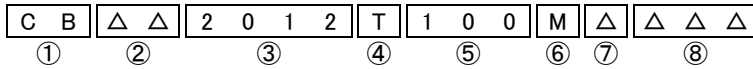

△ = Blank space

① Series name

Code	Series name
CB	Wound chip power inductor

② Characteristics

Code	Characteristics
△△	Standard
△C	High current
△L	Low profile
MF	Low loss

③ Dimensions (L × W)

Code	Type (inch)	Dimensions (L × W) [mm]
1608	1608 (0603)	1.6 × 0.8
2012	2012 (0805)	2.0 × 1.25
2016	2016 (0806)	2.0 × 1.6
2518	2518 (1007)	2.5 × 1.8
3225	3225 (1210)	3.2 × 2.5

④ Packaging

Code	Packaging
T	Taping

⑤ Nominal inductance

Code (example)	Nominal inductance [μH]
1R0	1.0
100	10
101	100

※R=Decimal point

⑥ Inductance tolerance

Code	Inductance tolerance
K	±10%
M	±20%

⑦ Special code

Code	Special code
△	Standard
R	Low Rdc type

⑧ Internal code

STANDARD EXTERNAL DIMENSIONS / STANDARD QUANTITY

CB/CB C/CB L

CBMF

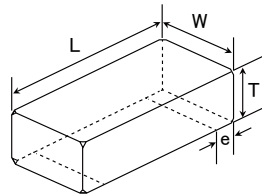
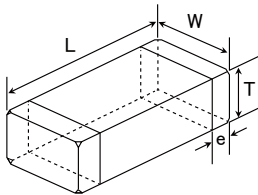

Recommended Land Patterns

Surface Mounting

- * Mounting and soldering conditions should be checked beforehand.
- * Applicable soldering process to these products is reflow soldering only.

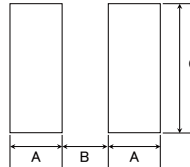

Type	A	B	C
MF1608	0.55	0.7	1.0
2012	0.60	1.0	1.45
2016	0.60	1.0	1.8
2518	0.60	1.5	2.0
3225	0.85	1.7	2.7

Unit: mm

Type	L	W	T	e	Standard quantity [pcs]	
					Paper tape	Embossed tape
CBMF1608	1.6 ± 0.2 (0.063 ± 0.008)	0.8 ± 0.2 (0.031 ± 0.008)	0.8 ± 0.2 (0.031 ± 0.008)	0.45 ± 0.15 (0.016 ± 0.006)	—	3000
CB L2012	2.0 ± 0.2 (0.079 ± 0.008)	1.25 ± 0.2 (0.049 ± 0.008)	0.9 ± 0.1 (0.035 ± 0.004)	0.5 ± 0.2 (0.020 ± 0.008)	4000	—
CB 2012	2.0 ± 0.2	1.25 ± 0.2	1.25 ± 0.2	0.5 ± 0.2	—	3000
CB C2012	(0.079 ± 0.008)	(0.049 ± 0.008)	(0.049 ± 0.008)	(0.020 ± 0.008)	—	3000
CB 2016	2.0 ± 0.2	1.6 ± 0.2	1.6 ± 0.2	0.5 ± 0.2	—	2000
CB C2016	(0.079 ± 0.008)	(0.063 ± 0.008)	(0.063 ± 0.008)	(0.020 ± 0.008)	—	2000
CB 2518	2.5 ± 0.2	1.8 ± 0.2	1.8 ± 0.2	0.5 ± 0.2	—	2000
CB C2518	(0.098 ± 0.008)	(0.071 ± 0.008)	(0.071 ± 0.008)	(0.020 ± 0.008)	—	2000
CB C3225	3.2 ± 0.2 (0.126 ± 0.008)	2.5 ± 0.2 (0.098 ± 0.008)	2.5 ± 0.2 (0.098 ± 0.008)	0.6 ± 0.3 (0.024 ± 0.012)	—	1000

Unit: mm (inch)

▶ This catalog contains the typical specification only due to the limitation of space. When you consider the purchase of our products, please check our product specification sheets. For details of each product (characteristics graph, reliability information, precautions for use, and so on), see our website (<http://www.ty-top.com/>).

■ PARTS NUMBER

● 1608 (0603) type

Parts number	EHS	Nominal inductance [μ H]	Inductance tolerance	Self-resonant frequency [MHz] (min.)	DC Resistance [Ω] ($\pm 30\%$)	Rated current ※) [mA]		Measuring frequency [MHz]
						Saturation current Idc1	Temperature rise current Idc2	
CBMF1608T1R0M	RoHS	1.0	$\pm 20\%$	100	0.09	290	770	7.96
CBMF1608T2R2M	RoHS	2.2	$\pm 20\%$	80	0.17	190	560	7.96
CBMF1608T3R3M	RoHS	3.3	$\pm 20\%$	60	0.22	170	500	7.96
CBMF1608T4R7M	RoHS	4.7	$\pm 20\%$	45	0.24	145	470	7.96
CBMF1608T100□	RoHS	10	$\pm 10\%$, $\pm 20\%$	32	0.36	115	380	2.52
CBMF1608T220□	RoHS	22	$\pm 10\%$, $\pm 20\%$	16	1.0	70	230	2.52
CBMF1608T470□	RoHS	47	$\pm 10\%$, $\pm 20\%$	11	2.5	50	140	2.52

● 2012 (0805) type

Parts number	EHS	Nominal inductance [μ H]	Inductance tolerance	Self-resonant frequency [MHz] (min.)	DC Resistance [Ω] ($\pm 30\%$)	Rated current ※) [mA]		Measuring frequency [MHz]
						Saturation current Idc1	Temperature rise current Idc2	
CB 2012T1R0M	RoHS	1.0	$\pm 20\%$	100	0.15	500	900	7.96
CB 2012T2R2M	RoHS	2.2	$\pm 20\%$	80	0.23	410	770	7.96
CB 2012T3R3M	RoHS	3.3	$\pm 20\%$	55	0.30	330	650	7.96
CB 2012T4R7M	RoHS	4.7	$\pm 20\%$	45	0.40	300	580	7.96
CB 2012T6R8M	RoHS	6.8	$\pm 20\%$	38	0.47	250	540	7.96
CB 2012T100□	RoHS	10	$\pm 10\%$, $\pm 20\%$	32	0.70	190	440	2.52
CB 2012T100□R	RoHS	10	$\pm 10\%$, $\pm 20\%$	32	0.50	200	520	2.52
CB 2012T150□	RoHS	15	$\pm 10\%$, $\pm 20\%$	28	1.3	170	320	2.52
CB 2012T220□	RoHS	22	$\pm 10\%$, $\pm 20\%$	16	1.7	135	280	2.52
CB 2012T470□	RoHS	47	$\pm 10\%$, $\pm 20\%$	11	3.7	90	190	2.52
CB 2012T680□	RoHS	68	$\pm 10\%$, $\pm 20\%$	10	6.0	70	140	2.52
CB 2012T101□	RoHS	100	$\pm 10\%$, $\pm 20\%$	8	7.0	60	130	0.796

Parts number	EHS	Nominal inductance [μ H]	Inductance tolerance	Self-resonant frequency [MHz] (min.)	DC Resistance [Ω] ($\pm 30\%$)	Rated current ※) [mA]		Measuring frequency [MHz]
						Saturation current Idc1	Temperature rise current Idc2	
CB C2012T1R0M	RoHS	1.0	$\pm 20\%$	100	0.19	700	840	7.96
CB C2012T2R2M	RoHS	2.2	$\pm 20\%$	70	0.33	530	640	7.96
CB C2012T4R7M	RoHS	4.7	$\pm 20\%$	45	0.50	360	520	7.96
CB C2012T100□	RoHS	10	$\pm 10\%$, $\pm 20\%$	40	1.2	240	340	2.52
CB C2012T220□	RoHS	22	$\pm 10\%$, $\pm 20\%$	16	3.7	170	190	2.52
CB C2012T470□	RoHS	47	$\pm 10\%$, $\pm 20\%$	11	5.8	120	150	2.52

Parts number	EHS	Nominal inductance [μ H]	Inductance tolerance	Self-resonant frequency [MHz] (min.)	DC Resistance [Ω] ($\pm 30\%$)	Rated current ※) [mA]		Measuring frequency [MHz]
						Saturation current Idc1	Temperature rise current Idc2	
CB L2012T1R0M	RoHS	1.0	$\pm 20\%$	100	0.15	620	950	0.1
CB L2012T2R2M	RoHS	2.2	$\pm 20\%$	80	0.39	440	590	0.1
CB L2012T4R7M	RoHS	4.7	$\pm 20\%$	45	0.66	275	490	0.1
CB L2012T100M	RoHS	10	$\pm 20\%$	32	1.0	205	370	0.1
CB L2012T220M	RoHS	22	$\pm 20\%$	23	2.1	150	250	0.1
CB L2012T470M	RoHS	47	$\pm 20\%$	11	4.2	100	140	0.1

● 2016 (0806) type

Parts number	EHS	Nominal inductance [μ H]	Inductance tolerance	Self-resonant frequency [MHz] (min.)	DC Resistance [Ω] ($\pm 30\%$)	Rated current ※) [mA]		Measuring frequency [MHz]
						Saturation current Idc1	Temperature rise current Idc2	
CB 2016T1R0M	RoHS	1.0	$\pm 20\%$	100	0.09	600	1,100	7.96
CB 2016T1R5M	RoHS	1.5	$\pm 20\%$	80	0.11	550	1,000	7.96
CB 2016T2R2M	RoHS	2.2	$\pm 20\%$	70	0.13	510	1,000	7.96
CB 2016T3R3M	RoHS	3.3	$\pm 20\%$	55	0.20	400	800	7.96
CB 2016T4R7M	RoHS	4.7	$\pm 20\%$	45	0.25	340	740	7.96
CB 2016T6R8M	RoHS	6.8	$\pm 20\%$	38	0.35	300	600	7.96
CB 2016T100□	RoHS	10	$\pm 10\%$, $\pm 20\%$	32	0.50	250	520	2.52
CB 2016T150□	RoHS	15	$\pm 10\%$, $\pm 20\%$	28	0.70	210	440	2.52
CB 2016T220□	RoHS	22	$\pm 10\%$, $\pm 20\%$	16	1.0	165	370	2.52
CB 2016T330□	RoHS	33	$\pm 10\%$, $\pm 20\%$	14	1.7	130	270	2.52
CB 2016T470□	RoHS	47	$\pm 10\%$, $\pm 20\%$	11	2.4	110	240	2.52
CB 2016T680□	RoHS	68	$\pm 10\%$, $\pm 20\%$	10	3.0	90	210	2.52
CB 2016T101□	RoHS	100	$\pm 10\%$, $\pm 20\%$	8	4.5	70	170	0.796

□ Please specify the Inductance tolerance code (K or M)

※) The saturation current value (Idc1) is the DC current value having inductance decrease down to 30%. (at 20°C)

※) The temperature rise current value (Idc2) is the DC current value having temperature increase by 40°C. (at 20°C)

※) The rated current value is following either Idc1 or Idc2, which is the lower one.

■ PARTS NUMBER

Parts number	EHS	Nominal inductance [μH]	Inductance tolerance	Self-resonant frequency [MHz] (min.)	DC Resistance [Ω] (±30%)	Rated current ※) [mA]		Measuring frequency [MHz]
						Saturation current Idc1	Temperature rise current Idc2	
CB C2016T1R0M	RoHS	1.0	±20%	100	0.10	1,100	1,100	7.96
CB C2016T1R5M	RoHS	1.5	±20%	80	0.15	1,000	1,000	7.96
CB C2016T2R2M	RoHS	2.2	±20%	70	0.20	750	720	7.96
CB C2016T3R3M	RoHS	3.3	±20%	55	0.27	600	610	7.96
CB C2016T4R7M	RoHS	4.7	±20%	45	0.37	550	530	7.96
CB C2016T6R8M	RoHS	6.8	±20%	38	0.59	450	450	7.96
CB C2016T100□	RoHS	10	±10%, ±20%	32	0.82	380	350	2.52
CB C2016T150□	RoHS	15	±10%, ±20%	28	1.2	300	300	2.52
CB C2016T220□	RoHS	22	±10%, ±20%	16	1.8	250	240	2.52
CB C2016T330□	RoHS	33	±10%, ±20%	14	2.8	220	220	2.52
CB C2016T470□	RoHS	47	±10%, ±20%	11	4.3	150	150	2.52
CB C2016T680□	RoHS	68	±10%, ±20%	10	7.0	130	130	2.52
CB C2016T101□	RoHS	100	±10%, ±20%	8	8.0	110	110	0.796

● 2518 (1007) type

Parts number	EHS	Nominal inductance [μH]	Inductance tolerance	Self-resonant frequency [MHz] (min.)	DC Resistance [Ω] (±30%)	Rated current ※) [mA]		Measuring frequency [MHz]
						Saturation current Idc1	Temperature rise current Idc2	
CB 2518T1R0M	RoHS	1.0	±20%	100	0.06	1,200	1,500	7.96
CB 2518T1R5M	RoHS	1.5	±20%	80	0.07	650	1,400	7.96
CB 2518T2R2M	RoHS	2.2	±20%	68	0.09	510	1,300	7.96
CB 2518T3R3M	RoHS	3.3	±20%	54	0.11	440	1,200	7.96
CB 2518T4R7MR	RoHS	4.7	±20%	46	0.10	310	1,200	7.96
CB 2518T4R7M	RoHS	4.7	±20%	46	0.13	340	1,100	7.96
CB 2518T6R8M	RoHS	6.8	±20%	38	0.15	270	930	7.96
CB 2518T100□	RoHS	10	±10%, ±20%	30	0.25	250	820	2.52
CB 2518T150□	RoHS	15	±10%, ±20%	23	0.32	180	650	2.52
CB 2518T220□	RoHS	22	±10%, ±20%	19	0.50	165	580	2.52
CB 2518T330□	RoHS	33	±10%, ±20%	15	0.70	130	460	2.52
CB 2518T470□	RoHS	47	±10%, ±20%	12	0.95	110	420	2.52
CB 2518T680□	RoHS	68	±10%, ±20%	9.5	1.5	70	310	2.52
CB 2518T101□	RoHS	100	±10%, ±20%	9.0	2.1	60	260	0.796
CB 2518T151□	RoHS	150	±10%, ±20%	7.0	3.2	55	210	0.796
CB 2518T221□	RoHS	220	±10%, ±20%	5.5	4.5	50	180	0.796
CB 2518T331□	RoHS	330	±10%, ±20%	4.5	7.0	40	140	0.796
CB 2518T471□	RoHS	470	±10%, ±20%	3.5	10	35	120	0.796
CB 2518T681□	RoHS	680	±10%, ±20%	3.0	17	30	90	0.796
CB 2518T102□	RoHS	1000	±10%, ±20%	2.4	24	25	75	0.252

Parts number	EHS	Nominal inductance [μH]	Inductance tolerance	Self-resonant frequency [MHz] (min.)	DC Resistance [Ω] (±30%)	Rated current ※) [mA]		Measuring frequency [MHz]
						Saturation current Idc1	Temperature rise current Idc2	
CB C2518T1R0M	RoHS	1.0	±20%	100	0.08	1,000	1,200	7.96
CB C2518T1R5M	RoHS	1.5	±20%	80	0.11	950	1,190	7.96
CB C2518T2R2M	RoHS	2.2	±20%	68	0.13	890	1,100	7.96
CB C2518T3R3M	RoHS	3.3	±20%	54	0.16	730	1,020	7.96
CB C2518T4R7M	RoHS	4.7	±20%	41	0.20	680	920	7.96
CB C2518T6R8M	RoHS	6.8	±20%	38	0.30	550	740	7.96
CB C2518T100□	RoHS	10	±10%, ±20%	30	0.36	480	680	2.52
CB C2518T150□	RoHS	15	±10%, ±20%	23	0.65	350	500	2.52
CB C2518T220□	RoHS	22	±10%, ±20%	19	0.77	320	460	2.52
CB C2518T330□	RoHS	33	±10%, ±20%	15	1.5	270	320	2.52
CB C2518T470□	RoHS	47	±10%, ±20%	12	1.9	240	290	2.52
CB C2518T680□	RoHS	68	±10%, ±20%	9.5	2.8	200	200	2.52
CB C2518T101□	RoHS	100	±10%, ±20%	9.0	3.7	160	170	0.796
CB C2518T151□	RoHS	150	±10%, ±20%	7.0	6.1	140	130	0.796
CB C2518T221□	RoHS	220	±10%, ±20%	5.5	8.4	115	110	0.796
CB C2518T331□	RoHS	330	±10%, ±20%	4.5	12.3	100	90	0.796
CB C2518T471□	RoHS	470	±10%, ±20%	3.5	22	80	70	0.796
CB C2518T681□	RoHS	680	±10%, ±20%	3.0	28	65	60	0.796

□ Please specify the Inductance tolerance code (Kor M)

- ※) The saturation current value (Idc1) is the DC current value having inductance decrease down to 30%. (at 20°C)
- ※) The temperature rise current value (Idc2) is the DC current value having temperature increase by 40°C. (at 20°C)
- ※) The rated current value is following either Idc1 or Idc2, which is the lower one.

■ PARTS NUMBER

● 3225 (1210) type

Parts number	EHS	Nominal inductance [μ H]	Inductance tolerance	Self-resonant frequency [MHz] (min.)	DC Resistance [Ω] ($\pm 30\%$)	Rated current ※) [mA]		Measuring frequency [MHz]
						Saturation current Idc1	Temperature rise current Idc2	
CB C3225T1R0MR	RoHS	1.0	$\pm 20\%$	250	0.055	2,000	1,440	0.1
CB C3225T1R5MR	RoHS	1.5	$\pm 20\%$	220	0.060	2,000	1,310	0.1
CB C3225T2R2MR	RoHS	2.2	$\pm 20\%$	190	0.080	2,000	1,130	0.1
CB C3225T3R3MR	RoHS	3.3	$\pm 20\%$	160	0.095	2,000	1,040	0.1
CB C3225T4R7MR	RoHS	4.7	$\pm 20\%$	70	0.100	1,250	1,010	0.1
CB C3225T6R8MR	RoHS	6.8	$\pm 20\%$	50	0.120	950	940	0.1
CB C3225T100□R	RoHS	10	$\pm 10\%$, $\pm 20\%$	23	0.133	900	900	0.1
CB C3225T150□R	RoHS	15	$\pm 10\%$, $\pm 20\%$	20	0.195	730	850	0.1
CB C3225T220□R	RoHS	22	$\pm 10\%$, $\pm 20\%$	17	0.27	620	780	0.1
CB C3225T330□R	RoHS	33	$\pm 10\%$, $\pm 20\%$	13	0.41	500	570	0.1
CB C3225T470□R	RoHS	47	$\pm 10\%$, $\pm 20\%$	10	0.67	390	480	0.1
CB C3225T680□R	RoHS	68	$\pm 10\%$, $\pm 20\%$	8.0	1.0	320	410	0.1
CB C3225T101□R	RoHS	100	$\pm 10\%$, $\pm 20\%$	6.0	1.4	270	340	0.1
CB C3225T221□R	RoHS	220	$\pm 10\%$, $\pm 20\%$	3.0	2.5	190	190	0.1
CB C3225T821□R	RoHS	820	$\pm 10\%$, $\pm 20\%$	1.8	12	110	110	0.1
CB C3225T102□R	RoHS	1000	$\pm 10\%$, $\pm 20\%$	1.6	13	100	100	0.1

□ Please specify the Inductance tolerance code (Kor M)

※) The saturation current value (Idc1) is the DC current value having inductance decrease down to 30%. (at 20°C)

※) The temperature rise current value (Idc2) is the DC current value having temperature increase by 40°C. (at 20°C)

※) The rated current value is following either Idc1 or Idc2, which is the lower one.

WIRE-WOUND CHIP INDUCTORS (LB SERIES), WIRE-WOUND CHIP POWER INDUCTORS (CB SERIES), WIRE-WOUND CHIP INDUCTORS FOR SIGNAL LINES (LB SERIES M TYPE)

PACKAGING

① Minimum Quantity

Type	Standard Quantity [pcs]	
	Paper Tape	Embossed Tape
LB C3225	—	1000
CB C3225	—	1000
LB 3218	—	2000
LB R2518	—	2000
LB C2518	—	2000
LB 2518	—	2000
CB 2518	—	2000
CB C2518	—	2000
LBM2016	—	2000
LB C2016	—	2000
LB 2016	—	2000
CB 2016	—	2000
CB C2016	—	2000
LB 2012	—	3000
LB C2012	—	3000
LB R2012	—	3000
CB 2012	—	3000
CB C2012	—	3000
CB L2012	4000	—
LB 1608	4000	—
LBMF1608	—	3000
CBMF1608	—	3000

② Tape material

● Embossed tape

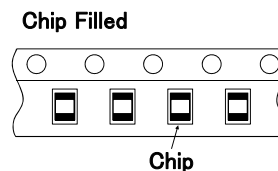
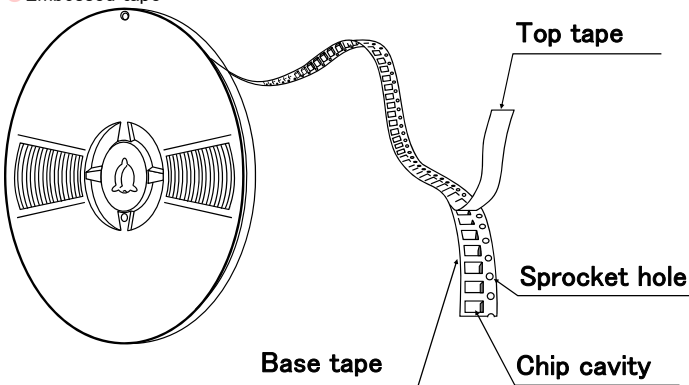

● Card board carrier tape

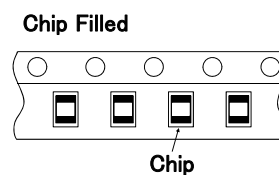
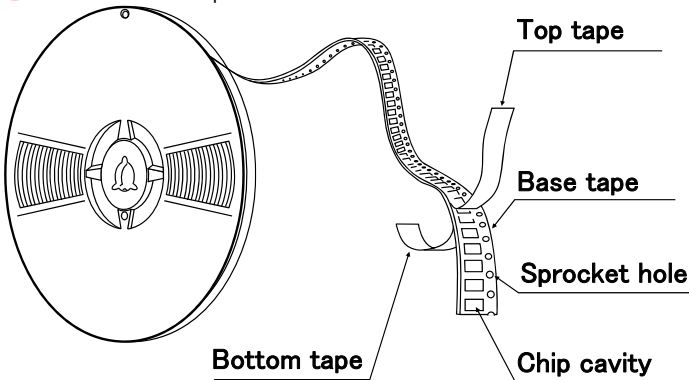

▶ This catalog contains the typical specification only due to the limitation of space. When you consider the purchase of our products, please check our specification. For details of each product (characteristics graph, reliability information, precautions for use, and so on), see our Web site (<http://www.ty-top.com/>).

③ Taping Dimensions

● Embossed Tape (0.315 inches wide)

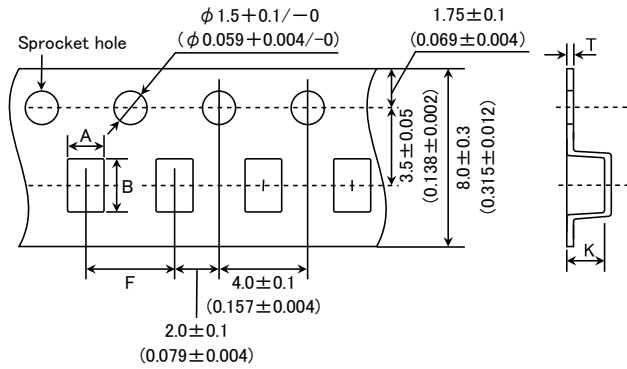

Type	Chip cavity		Insertion pitch	Tape thickness	
	A	B	F	T	K
LBM2016	1.75 ± 0.1 (0.069 ± 0.004)	2.1 ± 0.1 (0.083 ± 0.004)	4.0 ± 0.1 (0.157 ± 0.004)	0.3 ± 0.05 (0.012 ± 0.002)	1.9max. (0.075max.)
LB C3225 CB C3225	2.8 ± 0.1 (0.110 ± 0.004)	3.5 ± 0.1 (0.138 ± 0.004)	4.0 ± 0.1 (0.157 ± 0.004)	0.3 ± 0.05 (0.012 ± 0.002)	4.0max. (0.157max.)
LB 3218	2.1 ± 0.1 (0.083 ± 0.004)	3.5 ± 0.1 (0.138 ± 0.004)	4.0 ± 0.1 (0.157 ± 0.004)	0.3 ± 0.05 (0.012 ± 0.002)	2.2max. (0.087max.)
LB 2518 CB 2518 LB C2518 CB C2518 LB R2518	2.15 ± 0.1 (0.085 ± 0.004)	2.7 ± 0.1 (0.106 ± 0.004)	4.0 ± 0.1 (0.157 ± 0.004)	0.3 ± 0.05 (0.012 ± 0.002)	2.2max. (0.087max.)
LB 2016 CB 2016 LB C2016 CB C2016	1.75 ± 0.1 (0.069 ± 0.004)	2.1 ± 0.1 (0.083 ± 0.004)	4.0 ± 0.1 (0.157 ± 0.004)	0.3 ± 0.05 (0.012 ± 0.002)	1.9max. (0.075max.)
LB 2012 CB 2012 LB C2012 CB C2012 LB R2012	1.45 ± 0.1 (0.057 ± 0.004)	2.25 ± 0.1 (0.089 ± 0.004)	4.0 ± 0.1 (0.157 ± 0.004)	0.25 ± 0.05 (0.010 ± 0.002)	1.45max. (0.057max.)
LBMF1608 CBMF1608	1.1 ± 0.1 (0.043 ± 0.004)	1.9 ± 0.1 (0.075 ± 0.004)	4.0 ± 0.1 (0.157 ± 0.004)	0.25 ± 0.05 (0.010 ± 0.002)	1.2max. (0.047max.)

Unit: mm (inch)

● Card board carrier tape (0.315 inches wide)

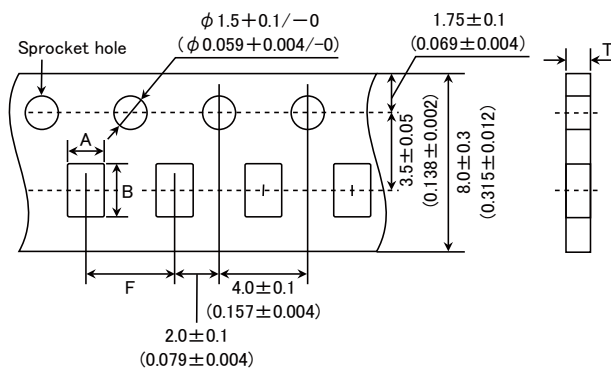

Type	Chip cavity		Insertion pitch	Tape thickness
	A	B	F	T
CB L2012	1.55 ± 0.1 (0.061 ± 0.004)	2.3 ± 0.1 (0.091 ± 0.004)	4.0 ± 0.1 (0.157 ± 0.004)	1.1max. (0.043max.)
LB 1608	1.0 ± 0.1 (0.039 ± 0.004)	1.8 ± 0.1 (0.071 ± 0.004)	4.0 ± 0.1 (0.157 ± 0.004)	1.1max. (0.043max.)

Unit: mm (inch)

④ Leader and Blank Portion

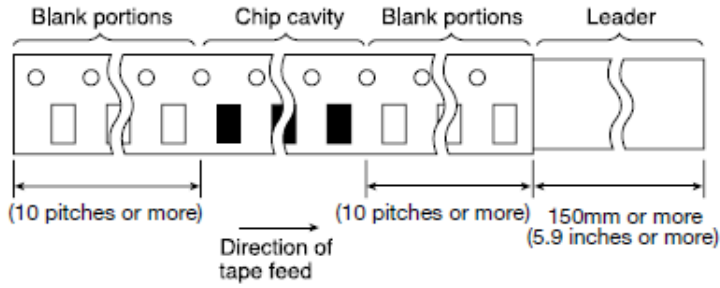

⑤ Reel Size

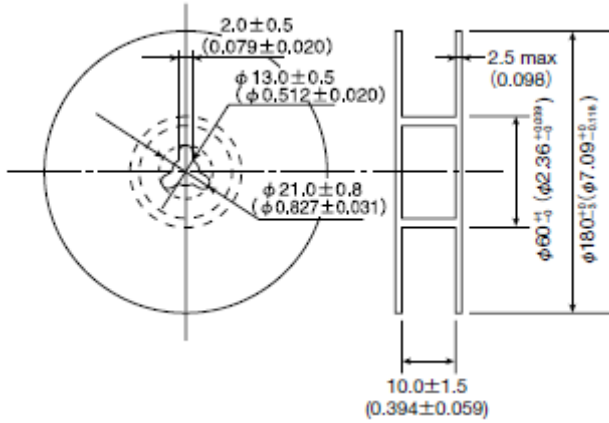

⑥ Top Tape Strength

The top tape requires a peel-off force 0.2 to 0.7N in the direction of the arrow as illustrated below.

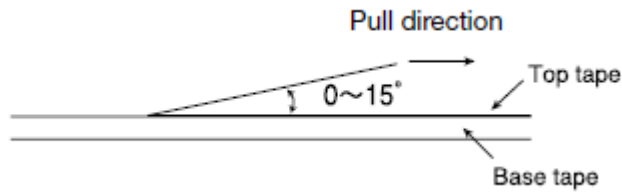

WIRE-WOUND CHIP INDUCTORS (LB SERIES), WIRE-WOUND CHIP POWER INDUCTORS (CB SERIES), WIRE-WOUND CHIP INDUCTORS FOR SIGNAL LINES (LB SERIES M TYPE)

RELIABILITY DATA

1. Operating temperature Range		
Specified Value	LB, LBC, LBR, LBMF Series	-40~ +105°C (Including self-generated heat)
	CB, CBC, CBL, CBMF Series	
	LBM Series	
2. Storage Temperature Range (after soldering)		
Specified Value	LB, LBC, LBR, LBMF Series	-40~ +85°C
	CB, CBC, CBL, CBMF Series	
	LBM Series	
Test Methods and Remarks	LB, CB Series : Please refer the term of "7. storage conditions" in precautions.	
3. Rated Current		
Specified Value	LB, LBC, LBR, LBMF Series	Within the specified tolerance
	CB, CBC, CBL, CBMF Series	
	LBM Series	
4. Inductance		
Specified Value	LB, LBC, LBR, LBMF Series	Within the specified tolerance
	CB, CBC, CBL, CBMF Series	
	LBM Series	
Test Methods and Remarks	LB・LBC・LBR・CB・CBC・CBL・LBMF・CBMF・LBM Series Measuring equipment : LCR Meter (HP4285A or its equivalent) Measuring frequency : Specified frequency	
5. Q		
Specified Value	LB, LBC, LBR, LBMF Series	-
	CB, CBC, CBL, CBMF Series	
	LBM Series	
Test Methods and Remarks	LBM Series Measuring equipment : LCR Meter (HP4285A or its equivalent) Measuring frequency : Specified frequency	
6. DC Resitance		
Specified Value	LB, LBC, LBR, LBMF Series	Within the specified tolerance
	CB, CBC, CBL, CBMF Series	
	LBM Series	
Test Methods and Remarks	Measuring equipment : DC Ohmmeter (HIOKI 3227 or its equivalent)	
7. Self-Resonant Frequency		
Specified Value	LB, LBC, LBR, LBMF Series	Within the specified tolerance
	CB, CBC, CBL, CBMF Series	
	LBM Series	
Test Methods and Remarks	Measuring equipment : Impedance analyzer (HP4291A or its equivalent)	

▶ This catalog contains the typical specification only due to the limitation of space. When you consider the purchase of our products, please check our specification.
For details of each product (characteristics graph, reliability information, precautions for use, and so on), see our Web site (<http://www.ty-top.com/>).

8. Temperature Characteristic					
Specified Value	LBM2016				Inductance change : Within $\pm 5\%$
	LB1608	LB2012	LBR2012	CB2012	Inductance change : Within $\pm 20\%$
	CBL2012	LB2016	CB2016	LB2518	
	LBR2518	CB2518	LBC3225	CBC3225	
	LBMF1608	CBMF1608	LBC2016	CBC2016	Inductance change : Within $\pm 25\%$
LBC2518	CBC2518	LB3218			
Test Methods and Remarks	LBC2012	CBC2012			Inductance change : Within $\pm 35\%$
	Based on the inductance at 20°C and Measured at the ambient of $-40^{\circ}\text{C} \sim +85^{\circ}\text{C}$.				

9. Resistance to Flexure of Substrate			
Specified Value	LB, LBC, LBR, LBMF Series		No damage.
	CB, CBC, CBL, CBMF Series		
	LBM Series		
Test Methods and Remarks	Warp : 2mm (LB·LBC·LBR·CB·CBC·CBL·LBM·LBMF·CBMF Series)		
	Test substrate : Glass epoxy-resin substrate Thickness : 0.8mm (LB1608·LBMF1608·CBMF1608) : 1.0mm (Others)		

10. Body Strength			
Specified Value	LB, LBC, LBR, LBMF Series		No damage.
	CB, CBC, CBL, CBMF Series		
	LBM Series		
Test Methods and Remarks	LB·LBC·LBR·CB·CBC·CBL·LBM		
	Applied force : 10N Duration : 10sec. LB1608·LBMF1608·CBMF1608 Applied force : 5N Duration : 10sec.		

11. Adhesion of terminal electrode			
Specified Value	LB, LBC, LBR, LBMF Series		No abnormality.
	CB, CBC, CBL, CBMF Series		
	LBM Series		
Test Methods and Remarks	LB·LBC·LBR·CB·CBC·CBL·LBM·LBMF·CBMF		
	Applied force : 10N to X and Y directions Duration : 5 sec. Test substrate : Printed board LB1608·CBMF1608·LBMF1608 Applied force : 5N to X and Y directions Duration : 5 sec. Test substrate : Printed board		

▶ This catalog contains the typical specification only due to the limitation of space. When you consider the purchase of our products, please check our specification.
 For details of each product (characteristics graph, reliability information, precautions for use, and so on), see our Web site (<http://www.ty-top.com/>).

12. Resistance to vibration		
Specified Value	LB, LBC, LBR, LBMF Series	Inductance change : Within $\pm 10\%$ No significant abnormality in appearance.
	CB, CBC, CBL, CBMF Series	
	LBM Series	Inductance change : Within $\pm 5\%$ No significant abnormality in appearance.
Test Methods and Remarks	LB·LBR·LBC·CB·CBC·CBL·LBM·LBMF·CBMF :	
	The given sample is soldered to the board and then it is tested depending on the conditions of the following table.	
	Vibration Frequency	10~55Hz
	Total Amplitude	1.5mm (May not exceed acceleration 196m/s ²)
	Sweeping Method	10Hz to 55Hz to 10Hz for 1min.
	Time	X Y Z For 2 hours on each X, Y, and Z axis.
	Recovery	: At least 2 hrs of recovery under the standard condition after the test, followed by the measurement within 48 hrs.

13. Drop test		
Specified Value	LB, LBC, LBR, LBMF Series	—
	CB, CBC, CBL, CBMF Series	
	LBM Series	

14. Solderability		
Specified Value	LB, LBC, LBR, LBMF Series	At least 90% of surface of terminal electrode is covered by new
	CB, CBC, CBL, CBMF Series	
	LBM Series	
Test Methods and Remarks	LB·LBC·LBR·CB·CBC·CBL·LBM·LBMF·CBMF :	
	Solder temperature	: 245 \pm 5 $^{\circ}$ C
	Duration	: 5 \pm 0.5sec
	Flux	: Methanol solution with 25% of colophony

15. Resistance to soldering		
Specified Value	LB, LBC, LBR, LBMF Series	Inductance change : Within $\pm 10\%$
	CB, CBC, CBL, CBMF Series	
	LBM Series	Inductance change : Within $\pm 5\%$
Test Methods and Remarks	LB·LBC·LBR·CB·CBC·CBL·LBM·LBMF·CBMF :	
	3 times of reflow oven at 230 $^{\circ}$ C MIN for 40sec. with peak temperature at 260 $^{\circ}$ C for 5sec. Recovery : At least 2 hrs of recovery under the standard condition after the test, followed by the measurement within 48 hrs.	

16. Resistance to solvent		
Specified Value	LB, LBC, LBR, LBMF Series	—
	CB, CBC, CBL, CBMF Series	
	LBM Series	
Test Methods and Remarks	Solvent temperature	: Room temperature
	Type of solvent	: Isopropyl alcohol
	Cleaning conditions	: 90s. Immersion and cleaning.

17. Thermal shock			
Specified Value	LB, LBC, LBR, LBMF Series	Inductance change : Within $\pm 10\%$ No significant abnormality in appearance.	
	CB, CBC, CBL, CBMF Series		
	LBM Series		
Test Methods and Remarks	LB·LBC·LBR·CB·CBC·CBL·LBM·LBMF·CBMF :		
	The given sample is soldered to the board and then its Inductance is measured after 100cycles of the following conditions.		
	Conditions of 1 cycle		
	Step	Temperature ($^{\circ}$ C)	Duration (min)
	1	-40 \pm 3	30 \pm 3
	2	Room temperature	Within 3
3	+85 \pm 2	30 \pm 3	
4	Room temperature	Within 3	
	Recovery	: At least 2 hrs of recovery under the standard condition after the test, followed by the measurement within 48 hrs.	

▶ This catalog contains the typical specification only due to the limitation of space. When you consider the purchase of our products, please check our specification.
For details of each product (characteristics graph, reliability information, precautions for use, and so on), see our Web site (<http://www.ty-top.com/>).

18.Damp heat life test		
Specified Value	LB, LBC, LBR, LBMF Series	Inductance change : Within $\pm 10\%$ No significant abnormality in appearance.
	CB, CBC, CBL, CBMF Series	
	LBM Series	
Test Methods and Remarks	Temperature : $60 \pm 2^\circ\text{C}$ Humidity : $90 \sim 95\% \text{RH}$ Duration : 1000 hrs Recovery : At least 2 hrs of recovery under the standard condition after the test, followed by the measurement within 48 hrs.	

19.Loading under damp heat life test		
Specified Value	LB, LBC, LBR, LBMF Series	Inductance change : Within $\pm 10\%$ No significant abnormality in appearance.
	CB, CBC, CBL, CBMF Series	
	LBM Series	
Test Methods and Remarks	Temperature : $60 \pm 2^\circ\text{C}$ Humidity : $90 \sim 95\% \text{RH}$ Duration : 1000 hrs Applied current : Rated current Recovery : At least 2 hrs of recovery under the standard condition after the test, followed by the measurement within 48 hrs.	

20.High temperature life test		
Specified Value	LB, LBC, LBR, LBMF Series	—
	CB, CBC, CBL, CBMF Series	Inductance change : Within $\pm 10\%$ No significant abnormality in appearance.
	LBM Series	
Test Methods and Remarks	Temperature : $85 \pm 2^\circ\text{C}$ Duration : 1000 hrs Recovery : At least 2 hrs of recovery under the standard condition after the test, followed by the measurement within 48 hrs.	

21.Loading at high temperature life test		
Specified Value	LB, LBC, LBR, LBMF Series	Inductance change : Within $\pm 10\%$ (LBC3225 Series : Within $\pm 20\%$) No significant abnormality in appearance.
	CB, CBC, CBL, CBMF Series	
	LBM Series	—
Test Methods and Remarks	Temperature : $85 \pm 2^\circ\text{C}$ Duration : 1000 hrs Applied current : Rated current Recovery : At least 2 hrs of recovery under the standard condition after the test, followed by the measurement within 48 hrs.	

22.Low temperature life test		
Specified Value	LB, LBC, LBR, LBMF Series	Inductance change : Within $\pm 10\%$ No significant abnormality in appearance.
	CB, CBC, CBL, CBMF Series	
	LBM Series	
Test Methods and Remarks	Temperature : $-40 \pm 2^\circ\text{C}$ Duration : 1000 hrs Recovery : At least 2 hrs of recovery under the standard condition after the test, followed by the measurement within 48 hrs.	

23.Standard condition		
Specified Value	LB, LBC, LBR, LBMF Series	Standard test conditions Unless specified, Ambient temperature is $20 \pm 15^\circ\text{C}$ and the Relative humidity is $65 \pm 20\%$. If there is any doubt about the test results, further measurement shall be had within the following limits: Ambient Temperature: $20 \pm 2^\circ\text{C}$ Relative humidity: $65 \pm 5\%$ Inductance value is based on our standard measurement systems.
	CB, CBC, CBL, CBMF Series	
	LBM Series	

▶ This catalog contains the typical specification only due to the limitation of space. When you consider the purchase of our products, please check our specification.
For details of each product (characteristics graph, reliability information, precautions for use, and so on), see our Web site (<http://www.ty-top.com/>).

WIRE-WOUND CHIP INDUCTORS (LB SERIES), WIRE-WOUND CHIP POWER INDUCTORS (CB SERIES), WIRE-WOUND CHIP INDUCTORS FOR SIGNAL LINES (LB SERIES M TYPE)

■ PRECAUTIONS

1. Circuit Design	
Precautions	<p>◆Operating environment</p> <p>1. The products described in this specification are intended for use in general electronic equipment, (office supply equipment, telecommunications systems, measuring equipment, and household equipment). They are not intended for use in mission-critical equipment or systems requiring special quality and high reliability (traffic systems, safety equipment, aerospace systems, nuclear control systems and medical equipment including life-support systems,) where product failure might result in loss of life, injury or damage. For such uses, contact TAIYO YUDEN Sales Department in advance.</p>
2. PCB Design	
Precautions	<p>◆Land pattern design</p> <p>1. Please contact any of our offices for a land pattern, and refer to a recommended land pattern of a right figure or specifications.</p>
Technical considerations	<p>PRECAUTIONS 【Recommended Land Patterns】</p> <p>Surface Mounting</p> <ul style="list-style-type: none"> • Mounting and soldering conditions should be checked beforehand. • Applicable soldering process to those products is reflow soldering only.
3. Considerations for automatic placement	
Precautions	<p>◆Adjustment of mounting machine</p> <p>1. Excessive impact load should not be imposed on the products when mounting onto the PC boards.</p> <p>2. Mounting and soldering conditions should be checked beforehand.</p>
Technical considerations	<p>1. When installing products, care should be taken not to apply distortion stress as it may deform the products.</p>
4. Soldering	
Precautions	<p>◆Reflow soldering(LB and CB Types)</p> <p>1. For reflow soldering with either leaded or lead-free solder, the profile specified in "point for controlling" is recommended.</p> <p>◆Recommended conditions for using a soldering iron</p> <p>1. Put the soldering iron on the land-pattern. Soldering iron's temperature - Below 350°C Duration-3 seconds or less. The soldering iron should not come in contact with inductor directly.</p>
Technical considerations	<p>◆Reflow soldering(LB and CB Types)</p> <p>1. Reflow profile</p> <p>Temperature [°C]</p> <p>Heating Time [sec]</p> <p>150~180</p> <p>90±30sec</p> <p>30±10sec</p> <p>230°C min</p> <p>5sec max</p> <p>Peak: 260+0/-5°C</p> <p>◆Recommended conditions for using a soldering iron</p> <p>1. Components can be damaged by excessive heat where soldering conditions exceed the specified range.</p>
5. Cleaning	
Precautions	<p>◆Cleaning conditions</p> <p>Washing by supersonic waves shall be avoided.</p>
Technical considerations	<p>◆Cleaning conditions</p> <p>If washed by supersonic waves, the products might be broken.</p>

6. Handling	
Precautions	<ul style="list-style-type: none"> ◆ Handling <ol style="list-style-type: none"> 1. Keep the inductors away from all magnets and magnetic objects. ◆ Breakaway PC boards (splitting along perforations) <ol style="list-style-type: none"> 1. When splitting the PC board after mounting inductors, care should be taken not to give any stresses of deflection or twisting to the board. 2. Board separation should not be done manually, but by using the appropriate devices. ◆ Mechanical considerations <ol style="list-style-type: none"> 1. Please do not give the inductors any excessive mechanical shocks.
Technical considerations	<ul style="list-style-type: none"> ◆ Handling <ol style="list-style-type: none"> 1. There is a case that a characteristic varies with magnetic influence. ◆ Breakaway PC boards (splitting along perforations) <ol style="list-style-type: none"> 1. Planning pattern configurations and the position of products should be carefully performed to minimize stress. ◆ Mechanical considerations <ol style="list-style-type: none"> 1. There is a case to be damaged by a mechanical shock.

7. Storage conditions	
Precautions	<ul style="list-style-type: none"> ◆ Storage <ol style="list-style-type: none"> 1. To maintain the solderability of terminal electrodes and to keep the packing material in good condition, temperature and humidity in the storage area should be controlled. <ul style="list-style-type: none"> • Recommended conditions <ul style="list-style-type: none"> Ambient temperature : 0~40°C Humidity : Below 70% RH • The ambient temperature must be kept below 30°C. Even under ideal storage conditions, solderability of products electrodes may decrease as time passes. <ul style="list-style-type: none"> For this reason, product should be used within 6 months from the time of delivery. In case of storage over 6 months, solderability shall be checked before actual usage.
Technical considerations	<ul style="list-style-type: none"> ◆ Storage <ol style="list-style-type: none"> 1. Under a high temperature and humidity environment, problems such as reduced solderability caused by oxidation of terminal electrodes and deterioration of taping/packaging materials may take place.

MULTILAYER CHIP POWER INDUCTORS (CK SERIES P TYPE)

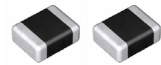

WAVE

REFLOW

■ PARTS NUMBER

* Operating Temp.: -40~+85°C

C	K	P	2	5	2	0	V	1	R	0	M	-	T	△
①	②	③	④	⑤	⑥	⑦								

△=Blank space

① Series name

Code	Series name
CKP	Multilayer chip power inductor

② Dimensions (L × W)

Code	Type (inch)	Dimensions (L × W) [mm]
1608	1608(0603)	1.6 × 0.8
2012	2012(0805)	2.0 × 1.25
2016	2016(0806)	2.0 × 1.6
2520	2520(1008)	2.5 × 2.0

③ Thickness

Code	Thickness [mm]
V	1.2 max
△	1.0 max
N	
C	
E	
D	0.95 max
M	0.8 max

④ Nominal inductance

Code (example)	Nominal inductance [μH]
1R0	1.0
R82	0.82

※R=Decimal point

⑤ Inductance tolerance

Code	Inductance tolerance
M	±20%

⑥ Packaging

Code	Packaging
-T	Taping

⑦ Internal code

Code	Internal code
△	Standard

■ STANDARD EXTERNAL DIMENSIONS / STANDARD QUANTITY

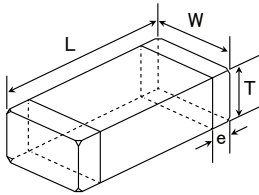

Type	L	W	T	e	Standard quantity [pcs]	
					Paper tape	Embossed tape
CKP1608 (0603)	1.6 ± 0.15 (0.063 ± 0.006)	0.8 ± 0.15 (0.031 ± 0.006)	0.95 max (0.037 max)	0.3 ± 0.2 (0.012 ± 0.008)	4000	—
CKP2012 (0805)	2.0 ± 0.2 (0.079 ± 0.008)	1.25 ± 0.2 (0.049 ± 0.008)	1.0 max (0.039 max)	0.5 ± 0.3 (0.02 ± 0.012)	—	3000
CKP2016 (0806)	2.0 ± 0.2 (0.079 ± 0.008)	1.6 ± 0.2 (0.063 ± 0.008)	1.0 max (0.039 max)	0.5 ± 0.3 (0.02 ± 0.012)	—	3000
CKP2520 (1008)	2.5 ± 0.2 (0.098 ± 0.008)	2.0 ± 0.2 (0.079 ± 0.008)	0.8 max (0.031 max)	0.5 ± 0.3 (0.02 ± 0.012)	—	3000
	2.5 ± 0.2 (0.098 ± 0.008)	2.0 ± 0.2 (0.079 ± 0.008)	1.0 max (0.039 max)	0.5 ± 0.3 (0.02 ± 0.012)	—	3000
	2.5 ± 0.2 (0.098 ± 0.008)	2.0 ± 0.2 (0.079 ± 0.008)	1.2 max (0.047 max)	0.5 ± 0.3 (0.02 ± 0.012)	—	2000

Unit: mm (inch)

▶ This catalog contains the typical specification only due to the limitation of space. When you consider the purchase of our products, please check our product specification sheets. For details of each product (characteristics graph, reliability information, precautions for use, and so on), see our website (<http://www.ty-top.com/>).

PARTS NUMBER

● CKP1608

Parts number	EHS	Nominal inductance [μ H]	Inductance tolerance	DC Resistance [Ω]		Rated current [A] (max.)	Measuring frequency [MHz]	Thickness [mm] (max.)
				(max.)	(typ.)			
CKP1608DR50M-T	RoHS	0.5	$\pm 20\%$	0.15	0.12	0.9	1	0.95
CKP1608D1R0M-T	RoHS	1.0	$\pm 20\%$	0.20	0.17	0.75	1	0.95
CKP1608D2R2M-T	RoHS	2.2	$\pm 20\%$	0.30	0.27	0.65	1	0.95

● CKP2012

Parts number	EHS	Nominal inductance [μ H]	Inductance tolerance	DC Resistance [Ω]		Rated current [A] (max.)	Measuring frequency [MHz]	Thickness [mm] (max.)
				(max.)	(typ.)			
CKP2012NR47M-T	RoHS	0.47	$\pm 20\%$	0.08	0.06	1.2	1	1.0
CKP2012N1R0M-T	RoHS	1.0	$\pm 20\%$	0.14	0.11	1.0	1	1.0
CKP2012N1R5M-T	RoHS	1.5	$\pm 20\%$	0.20	0.15	0.8	1	1.0
CKP2012N2R2M-T	RoHS	2.2	$\pm 20\%$	0.20	0.15	0.8	1	1.0
CKP2012N3R3M-T	RoHS	3.3	$\pm 20\%$	0.24	0.20	0.7	1	1.0
CKP2012N4R7M-T	RoHS	4.7	$\pm 20\%$	0.28	0.23	0.7	1	1.0
CKP2012E1R0M-T	RoHS	1.0	$\pm 20\%$	0.10	0.08	1.7	1	1.0
CKP2012E2R2M-T	RoHS	2.2	$\pm 20\%$	0.16	0.12	1.3	1	1.0

● CKP2016

Parts number	EHS	Nominal inductance [μ H]	Inductance tolerance	DC Resistance [Ω]		Rated current [A] (max.)	Measuring frequency [MHz]	Thickness [mm] (max.)
				(max.)	(typ.)			
CKP2016 R47M-T	RoHS	0.47	$\pm 20\%$	0.075	0.06	1.6	1	1.0
CKP2016 1R0M-T	RoHS	1.0	$\pm 20\%$	0.12	0.09	1.3	1	1.0
CKP2016 1R5M-T	RoHS	1.5	$\pm 20\%$	0.13	0.10	1.2	1	1.0
CKP2016 2R2M-T	RoHS	2.2	$\pm 20\%$	0.14	0.11	1.2	1	1.0
CKP2016 3R3M-T	RoHS	3.3	$\pm 20\%$	0.16	0.13	1.1	1	1.0
CKP2016 4R7M-T	RoHS	4.7	$\pm 20\%$	0.20	0.16	0.9	1	1.0

● CKP2520

Parts number	EHS	Nominal inductance [μ H]	Inductance tolerance	DC Resistance [Ω]		Rated current [A] (max.)	Measuring frequency [MHz]	Thickness [mm] (max.)
				(max.)	(typ.)			
CKP2520M1R5M-T	RoHS	1.5	$\pm 20\%$	0.09	0.075	1.3	1	0.8
CKP2520M2R2M-T	RoHS	2.2	$\pm 20\%$	0.10	0.08	1.2	1	0.8
CKP2520 R47M-T	RoHS	0.47	$\pm 20\%$	0.05	0.04	1.8	1	1.0
CKP2520 1R0M-T	RoHS	1.0	$\pm 20\%$	0.08	0.065	1.4	1	1.0
CKP2520 1R5M-T	RoHS	1.5	$\pm 20\%$	0.09	0.075	1.3	1	1.0
CKP2520 2R2M-T	RoHS	2.2	$\pm 20\%$	0.09	0.075	1.3	1	1.0
CKP2520 3R3M-T	RoHS	3.3	$\pm 20\%$	0.12	0.09	1.2	1	1.0
CKP2520 4R7M-T	RoHS	4.7	$\pm 20\%$	0.15	0.12	1.1	1	1.0
CKP2520C1R0M-T	RoHS	1.0	$\pm 20\%$	0.08	0.06	1.4	1	1.0
CKP2520N1R0M-T	RoHS	1.0	$\pm 20\%$	0.115	0.09	1.2	1	1.0
CKP2520N2R2M-T	RoHS	2.2	$\pm 20\%$	0.115	0.09	1.2	1	1.0
CKP2520N4R7M-T	RoHS	4.7	$\pm 20\%$	0.16	0.14	1.1	1	1.0
CKP2520V1R0M-T	RoHS	1.0	$\pm 20\%$	0.12	0.09	1.2	1	1.2
CKP2520V2R2M-T	RoHS	2.2	$\pm 20\%$	0.15	0.12	1.1	1	1.2
CKP2520V3R3M-T	RoHS	3.3	$\pm 20\%$	0.15	0.11	1.1	1	1.2
CKP2520V4R7M-T	RoHS	4.7	$\pm 20\%$	0.16	0.14	1.1	1	1.2

※ Rated current specifies that self-heat generation is below 40 degC during DC loaded (at 20 degC).

Multilayer chip inductors

Multilayer chip inductors for high frequency, Multilayer chip bead inductors

Multilayer common mode choke coils (MC series F type)

Metal Multilayer Chip Power Inductors (MCOIL™ MC series)

PACKAGING

① Minimum Quantity

● Tape & Reel Packaging

Type	Thickness mm (inch)	Standard Quantity [pcs]	
		Paper Tape	Embossed Tape
CK1608(0603)	0.8 (0.031)	4000	—
CK2125(0805)	0.85(0.033)	4000	—
	1.25(0.049)	—	2000
CKS2125(0805)	0.85(0.033)	4000	—
	1.25(0.049)	—	2000
CKP1608(0603)	0.8 (0.031)	4000	—
CKP2012(0805)	0.9 (0.035)	—	3000
CKP2016(0806)	0.9 (0.035)	—	3000
CKP2520(1008)	0.7 (0.028)	—	3000
	0.9 (0.035)	—	3000
	1.1 (0.043)	—	2000
LK1005(0402)	0.5 (0.020)	10000	—
LK1608(0603)	0.8 (0.031)	4000	—
LK2125(0805)	0.85(0.033)	4000	—
	1.25(0.049)	—	2000
HK0603(0201)	0.3 (0.012)	15000	—
HK1005(0402)	0.5 (0.020)	10000	—
HK1608(0603)	0.8 (0.031)	4000	—
HK2125(0805)	0.85(0.033)	—	4000
	1.0 (0.039)	—	3000
HKQ0603S(0201)	0.3 (0.012)	15000	—
HKQ0603U(0201)	0.3 (0.012)	15000	—
AQ105(0402)	0.5 (0.020)	10000	—
BK0603(0201)	0.3 (0.012)	15000	—
BK1005(0402)	0.5 (0.020)	10000	—
BKH0603(0201)	0.3 (0.012)	15000	—
BKH1005(0402)	0.5 (0.020)	10000	—
BK1608(0603)	0.8 (0.031)	4000	—
BK2125(0805)	0.85(0.033)	4000	—
	1.25(0.049)	—	2000
BK2010(0804)	0.45(0.018)	4000	—
BK3216(1206)	0.8 (0.031)	—	4000
BKP0603(0201)	0.3 (0.012)	15000	—
BKP1005(0402)	0.5 (0.020)	10000	—
BKP1608(0603)	0.8 (0.031)	4000	—
BKP2125(0805)	0.85(0.033)	4000	—
MCF0605(0202)	0.3 (0.012)	15000	—
MCF0806(0302)	0.4 (0.016)	—	10000
MCF1210(0504)	0.55(0.022)	—	5000
MCF2010(0804)	0.45(0.018)	—	4000
MCEE1005(0402)	0.55(0.022)	10000	—
MCEK1210(0504)	0.5 (0.020)	5000	—
MCFK1608(0603)	0.6 (0.024)	4000	—
MCFE1608(0603)	0.65(0.026)	4000	—
MCHK1608(0603)	0.8 (0.031)	4000	—
MCKK1608(0603)	1.0 (0.039)	—	3000
MCHK2012(0806)	0.8 (0.031)	4000	—
MCKK2012(0805)	1.0 (0.039)	—	3000

► This catalog contains the typical specification only due to the limitation of space. When you consider the purchase of our products, please check our specification. For details of each product (characteristics graph, reliability information, precautions for use, and so on), see our Web site (<http://www.ty-top.com/>).

② Taping material

● Card board carrier tape

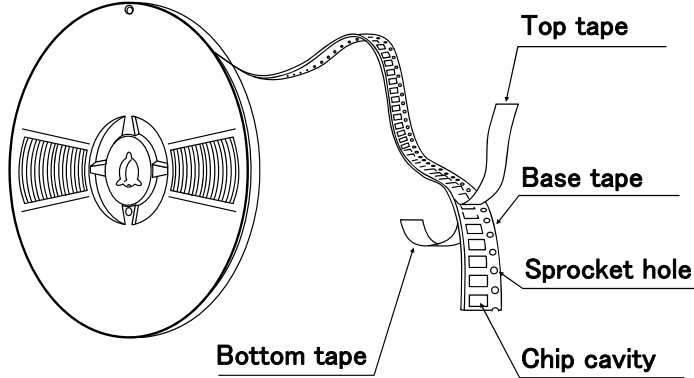

CK	1608
CKP	1608
CK	2125
CKS	2125
LK	1005
LK	1608
LK	2125
HK	0603
HK	1005
HK	1608
HKQ	0603
AQ	105

BK	0603
BK	1005
BK	1608
BK	2125
BK	2010
BKP	0603
BKP	1005
BKP	1608
BKP	2125
BKH	0603
BKH	1005
MCF	0605
MC	1005
MC	1210
MC	1608
MC	2012

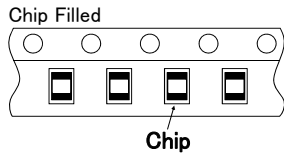

● Embossed Tape

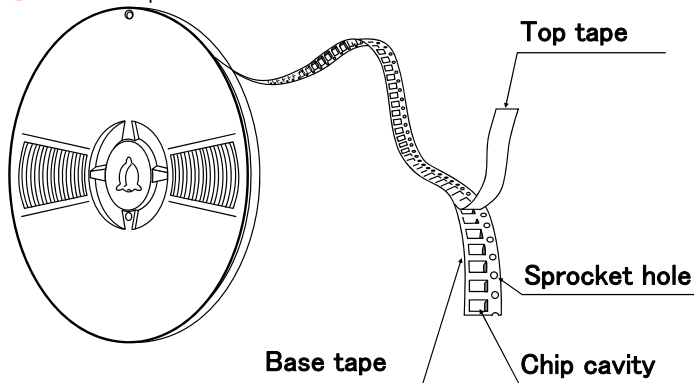

CK	2125
CKS	2125
CKP	2012
CKP	2016
CKP	2520
LK	2125
HK	2125

BK	2125
BK	3216
MCF	0806
MCF	1210
MCF	2010
MC	1608
MC	2012

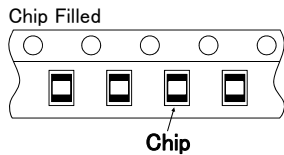

③ Taping Dimensions

● Paper tape (8mm wide)

Unit: mm (inch)

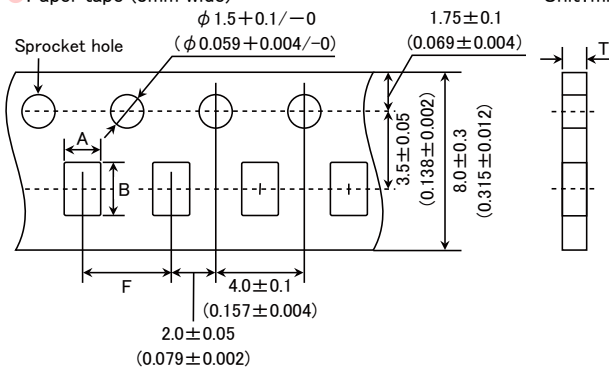

▶ This catalog contains the typical specification only due to the limitation of space. When you consider the purchase of our products, please check our specification. For details of each product (characteristics graph, reliability information, precautions for use, and so on), see our Web site (<http://www.ty-top.com/>).

Type	Thickness mm (inch)	Chip cavity		Insertion Pitch	Tape Thickness
		A	B	F	T
CK1608(0603)	0.8 (0.031)	1.0±0.2 (0.039±0.008)	1.8±0.2 (0.071±0.008)	4.0±0.1 (0.157±0.004)	1.1max (0.043max)
CK2125(0805)	0.85(0.033)	1.5±0.2 (0.059±0.008)	2.3±0.2 (0.091±0.008)	4.0±0.1 (0.157±0.004)	1.1max (0.043max)
CKS2125(0805)	0.85(0.033)	1.5±0.2 (0.059±0.008)	2.3±0.2 (0.091±0.008)	4.0±0.1 (0.157±0.004)	1.1max (0.043max)
CKP1608(0603)	0.8 (0.031)	1.0±0.2 (0.039±0.008)	1.8±0.2 (0.071±0.008)	4.0±0.1 (0.157±0.004)	1.1max (0.043max)
LK1005(0402)	0.5 (0.020)	0.65±0.1 (0.026±0.004)	1.15±0.1 (0.045±0.004)	2.0±0.05 (0.079±0.002)	0.8max (0.031max)
LK1608(0603)	0.8 (0.031)	1.0±0.2 (0.039±0.008)	1.8±0.2 (0.071±0.008)	4.0±0.1 (0.157±0.004)	1.1max (0.043max)
LK2125(0805)	0.85(0.033)	1.5±0.2 (0.059±0.008)	2.3±0.2 (0.091±0.008)	4.0±0.1 (0.157±0.004)	1.1max (0.043max)
HK0603(0201)	0.3 (0.012)	0.40±0.06 (0.016±0.002)	0.70±0.06 (0.028±0.002)	2.0±0.05 (0.079±0.002)	0.45max (0.018max)
HK1005(0402)	0.5 (0.020)	0.65±0.1 (0.026±0.004)	1.15±0.1 (0.045±0.004)	2.0±0.05 (0.079±0.002)	0.8max (0.031max)
HK1608(0603)	0.8 (0.031)	1.0±0.2 (0.039±0.008)	1.8±0.2 (0.071±0.008)	4.0±0.1 (0.157±0.004)	1.1max (0.043max)
HKQ0603S(0201)	0.3 (0.012)	0.40±0.06 (0.016±0.002)	0.70±0.06 (0.028±0.002)	2.0±0.05 (0.079±0.002)	0.45max (0.018max)
HKQ0603U(0201)	0.3 (0.012)	0.40±0.06 (0.016±0.002)	0.70±0.06 (0.028±0.002)	2.0±0.05 (0.079±0.002)	0.45max (0.018max)
AQ105(0402)	0.5 (0.020)	0.75±0.1 (0.030±0.004)	1.15±0.1 (0.045±0.004)	2.0±0.05 (0.079±0.002)	0.8max (0.031max)
BK0603(0201)	0.3 (0.012)	0.40±0.06 (0.016±0.002)	0.70±0.06 (0.028±0.002)	2.0±0.05 (0.079±0.002)	0.45max (0.018max)
BK1005(0402)	0.5 (0.020)	0.65±0.1 (0.026±0.004)	1.15±0.1 (0.045±0.004)	2.0±0.05 (0.079±0.002)	0.8max (0.031max)
BK1608(0603)	0.8 (0.031)	1.0±0.2 (0.039±0.008)	1.8±0.2 (0.071±0.008)	4.0±0.1 (0.157±0.004)	1.1max (0.043max)
BK2125(0805)	0.85(0.033)	1.5±0.2 (0.059±0.008)	2.3±0.2 (0.091±0.008)	4.0±0.1 (0.157±0.004)	1.1max (0.043max)
BK2010(0804)	0.45(0.018)	1.2±0.1 (0.047±0.004)	2.17±0.1 (0.085±0.004)	4.0±0.1 (0.157±0.004)	0.8max (0.031max)
BKP0603(0201)	0.3 (0.012)	0.40±0.06 (0.016±0.002)	0.70±0.06 (0.028±0.002)	2.0±0.05 (0.079±0.002)	0.45max (0.018max)
BKP1005(0402)	0.5 (0.020)	0.65±0.1 (0.026±0.004)	1.15±0.1 (0.045±0.004)	2.0±0.05 (0.079±0.002)	0.8max (0.031max)
BKP1608(0603)	0.8 (0.031)	1.0±0.2 (0.039±0.008)	1.8±0.2 (0.071±0.008)	4.0±0.1 (0.157±0.004)	1.1max (0.043max)
BKP2125(0805)	0.85(0.033)	1.5±0.2 (0.059±0.008)	2.3±0.2 (0.091±0.008)	4.0±0.1 (0.157±0.004)	1.1max (0.043max)
BKH0603(0201)	0.3 (0.012)	0.40±0.06 (0.016±0.002)	0.70±0.06 (0.028±0.002)	2.0±0.05 (0.079±0.002)	0.45max (0.018max)
BKH1005(0402)	0.5 (0.020)	0.65±0.1 (0.026±0.004)	1.15±0.1 (0.045±0.004)	2.0±0.05 (0.079±0.002)	0.8max (0.031max)
MCF0605(0202)	0.3 (0.012)	0.62±0.03 (0.024±0.001)	0.77±0.03 (0.030±0.001)	2.0±0.05 (0.079±0.002)	0.45max (0.018max)
MCFK1608(0603)	0.6 (0.024)	1.1±0.05 (0.043±0.002)	1.9±0.05 (0.075±0.002)	4.0±0.1 (0.157±0.004)	0.72max (0.028max)
MCEE1005(0402)	0.55(0.021)	0.8±0.05 (0.031±0.002)	1.3±0.05 (0.051±0.002)	2.0±0.05 (0.079±0.002)	0.64max (0.025max)
MCEK1210(0504)	0.5 (0.020)	1.3±0.1 (0.051±0.004)	1.55±0.1 (0.061±0.004)	4.0±0.1 (0.157±0.004)	0.64max (0.025max)
MCFK1608(0603)	0.6 (0.024)	1.1±0.05 (0.043±0.002)	1.9±0.05 (0.075±0.002)	4.0±0.1 (0.157±0.004)	0.72max (0.028max)
MCFE1608(0603)	0.65(0.026)	1.1±0.05 (0.043±0.002)	1.9±0.05 (0.075±0.002)	4.0±0.1 (0.157±0.004)	0.72max (0.028max)
MCHK1608(0603)	0.8 (0.031)	1.2±0.05 (0.047±0.002)	2.0±0.05 (0.079±0.002)	4.0±0.1 (0.157±0.004)	0.9max (0.035max)
MCHK2012(0805)	0.8 (0.031)	1.65±0.1 (0.065±0.004)	2.4±0.1 (0.094±0.004)	4.0±0.1 (0.157±0.004)	0.9max (0.035max)

Unit : mm (inch)

● Embossed Tape (8mm wide)

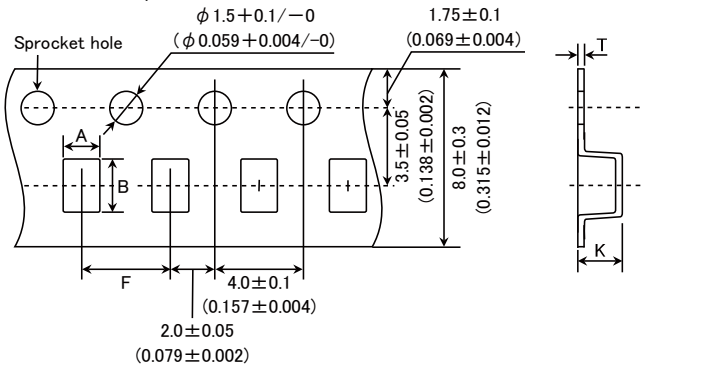

Type	Thickness mm (inch)	Chip cavity		Insertion Pitch	Tape Thickness	
		A	B	F	K	T
CK2125(0805)	1.25 (0.049)	1.5 ± 0.2 (0.059 ± 0.008)	2.3 ± 0.2 (0.091 ± 0.008)	4.0 ± 0.1 (0.157 ± 0.004)	2.0 (0.079)	0.3 (0.012)
CKS2125(0805)	1.25 (0.049)	1.5 ± 0.2 (0.059 ± 0.008)	2.3 ± 0.2 (0.091 ± 0.008)	4.0 ± 0.1 (0.157 ± 0.004)	2.0 (0.079)	0.3 (0.012)
CKP2012(0805)	0.9 (0.035)	1.55 ± 0.2 (0.061 ± 0.008)	2.3 ± 0.2 (0.091 ± 0.008)	4.0 ± 0.1 (0.157 ± 0.004)	1.3 (0.051)	0.3 (0.012)
CKP2016(0806)	0.9 (0.035)	1.8 ± 0.1 (0.071 ± 0.004)	2.2 ± 0.1 (0.087 ± 0.004)	4.0 ± 0.1 (0.157 ± 0.004)	1.3 (0.051)	0.25 (0.01)
CKP2520(1008)	0.7 (0.028)	2.3 ± 0.1 (0.091 ± 0.004)	2.8 ± 0.1 (0.110 ± 0.004)	4.0 ± 0.1 (0.157 ± 0.004)	1.4 (0.055)	0.3 (0.012)
	0.9 (0.035)				1.4 (0.055)	
	1.1 (0.043)				1.7 (0.067)	
	1.1 (0.043)				1.7 (0.067)	
LK2125(0805)	1.25 (0.049)	1.5 ± 0.2 (0.059 ± 0.008)	2.3 ± 0.2 (0.091 ± 0.008)	4.0 ± 0.1 (0.157 ± 0.004)	2.0 (0.079)	0.3 (0.012)
HK2125(0805)	0.85 (0.033)	1.5 ± 0.2 (0.059 ± 0.008)	2.3 ± 0.2 (0.091 ± 0.008)	4.0 ± 0.1 (0.157 ± 0.004)	1.5 (0.059)	0.3 (0.012)
	1.0 (0.039)				2.0 (0.079)	
BK2125(0805)	1.25 (0.049)	1.5 ± 0.2 (0.059 ± 0.008)	2.3 ± 0.2 (0.091 ± 0.008)	4.0 ± 0.1 (0.157 ± 0.004)	2.0 (0.079)	0.3 (0.012)
BK3216(1206)	0.8 (0.031)	1.9 ± 0.1 (0.075 ± 0.004)	3.5 ± 0.1 (0.138 ± 0.004)	4.0 ± 0.1 (0.157 ± 0.004)	1.4 (0.055)	0.3 (0.012)
MCF0806(0302)	0.4 (0.016)	0.75 ± 0.05 (0.030 ± 0.002)	0.95 ± 0.05 (0.037 ± 0.002)	2.0 ± 0.05 (0.079 ± 0.002)	0.55 (0.022)	0.3 (0.012)
MCF1210(0504)	0.55 (0.022)	1.15 ± 0.05 (0.045 ± 0.002)	1.40 ± 0.05 (0.055 ± 0.002)	4.0 ± 0.1 (0.157 ± 0.004)	0.65 (0.026)	0.3 (0.012)
MCF2010(0804)	0.45 (0.018)	1.1 ± 0.1 (0.043 ± 0.004)	2.3 ± 0.1 (0.091 ± 0.004)	4.0 ± 0.1 (0.157 ± 0.004)	0.85 (0.033)	0.3 (0.012)
MCKK1608(0603)	1.0 (0.039)	1.1 ± 0.1 (0.043 ± 0.004)	1.95 ± 0.1 (± 0.004)	4.0 ± 0.1 (0.157 ± 0.004)	1.4 (0.055)	0.25 (0.01)
MCKK2012(0805)	1.0 (0.039)	1.55 ± 0.1 (0.061 ± 0.004)	2.35 ± 0.1 (0.093 ± 0.004)	4.0 ± 0.1 (0.157 ± 0.004)	1.35 (0.053)	0.25 (0.010)

Unit : mm (inch)

④ LEADER AND BLANK PORTION

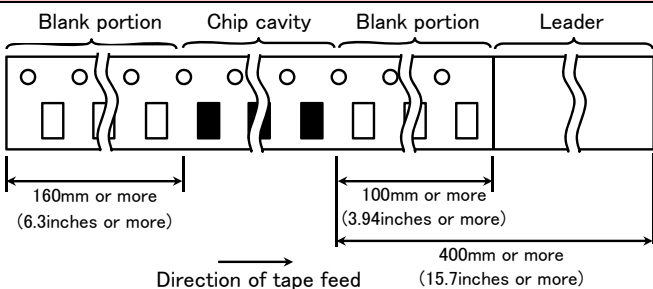

▶ This catalog contains the typical specification only due to the limitation of space. When you consider the purchase of our products, please check our specification. For details of each product (characteristics graph, reliability information, precautions for use, and so on), see our Web site (<http://www.ty-top.com/>).

⑤ Reel Size

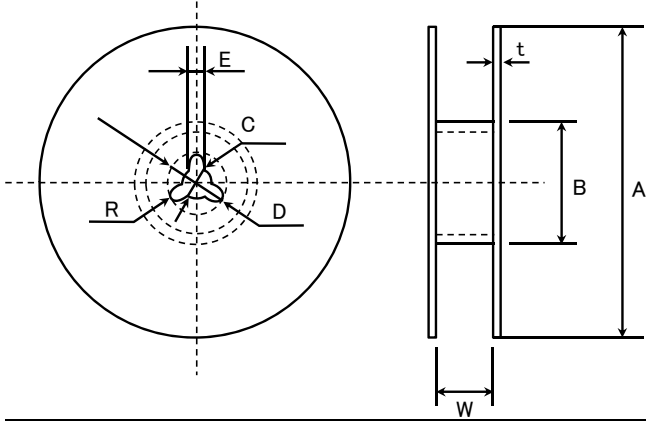

A	B	C	D	E	R
$\phi 178 \pm 2.0$	$\phi 50$ or more	$\phi 13.0 \pm 0.2$	$\phi 21.0 \pm 0.8$	2.0 ± 0.5	1.0

	t	W
4mm width tape	1.5max.	5 ± 1.0
8mm width tape	2.5max.	10 ± 1.5

(Unit : mm)

⑥ Top tape strength

The top tape requires a peel-off force of 0.1~0.7N in the direction of the arrow as illustrated below.

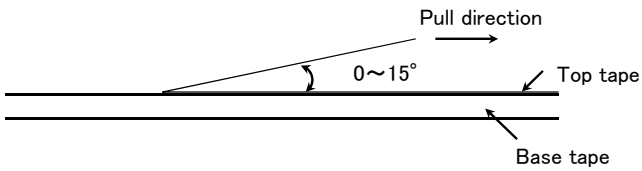

Multilayer chip inductors

Multilayer chip inductors for high frequency, Multilayer chip bead inductors

Multilayer common mode choke coils (MC series F type)

Metal Multilayer Chip Power Inductors (MCOIL™ MC series)

RELIABILITY DATA

1. Operating Temperature Range		
Specified Value	BK series	-55 ~ +125°C
	BKH series	
	BKP series	
	MCF series	-40 ~ +85°C
	CK series	-40 ~ +85°C
	CKS series	
	CKP series	
	LK series	
	HK0603, HK1005	-55 ~ +125°C
	HK1608, HK2125	-40 ~ +85°C
	HKQ0603	-55 ~ +125°C
	AQ105	
	MCOIL™ MC series	-40 ~ +125°C (Including self-generated heat)
2. Storage Temperature Range		
Specified Value	BK series	-55 ~ +125°C
	BKH series	
	BKP series	
	MCF series	-40 ~ +85°C
	CK series	-40 ~ +85°C
	CKS series	
	CKP series	
	LK series	
	HK0603, HK1005	-55 ~ +125°C
	HK1608, HK2125	-40 ~ +85°C
	HKQ0603	-55 ~ +125°C
	AQ105	
	MCOIL™ MC series	-40 ~ +85°C
3. Rated Current		
Specified Value	BK series	The temperature of the element is increased within 20°C.
	BKH series	
	BKP series	The temperature of the element is increased within 40°C
	MCF series	Refer to each specification.
	CK series	The temperature of the element is increased within 20°C.
	CKS series	
	CKP series	
	LK series	The decreasing-rate of inductance value is within 5 %
	HK0603, HK1005	The decreasing-rate of inductance value is within 5 %, or the temperature of the element is increased within 20°C
	HK1608, HK2125	
	HKQ0603	
	AQ105	
	MCOIL™ MC series	
	Idc1: The decreasing-rate of inductance value is within 30 % Idc2: The temperature of the element is increased within 40°C	

► This catalog contains the typical specification only due to the limitation of space. When you consider the purchase of our products, please check our specification.
For details of each product (characteristics graph, reliability information, precautions for use, and so on), see our Web site (<http://www.ty-top.com/>).

4. Impedance		
Specified Value	BK series	Refer to each specification.
	BKH series	
	BKP series	
	MCF series	
Test Methods and Remarks	BK0603Series, BKP0603Series, BKH Series Measuring frequency : 100±1MHz Measuring equipment : 4991A (or its equivalent) Measuring jig : 16193A (or its equivalent)	
	BK1005Series, BKP1005Series, BKH1005Series Measuring frequency : 100±1MHz Measuring equipment : 4291A (or its equivalent) Measuring jig : 16192A (or its equivalent) , HW:16193A (or its equivalent)	
	BK1608・2125Series, BKP1608・2125Series Measuring frequency : 100±1MHz Measuring equipment : 4291A (or its equivalent), 4195A (or its equivalent) Measuring jig : 16192A (or its equivalent), HW:16193A (or its equivalent)	
	BK2010・3216Series Measuring frequency : 100±1MHz Measuring equipment : 4291A (or its equivalent), 4195A (or its equivalent) Measuring jig : 16192A (or its equivalent)	
	MCF Series Measuring frequency : 100±1MHz Measuring equipment : 4291A (or its equivalent)	

5. Inductance		
Specified Value	CK series	Refer to each specification.
	CKS series	
	CKP series	
	LK series	
	HK0603, HK1005	
	HK1608, HK2125	
	HKQ0603	
	AQ105	
Test Methods and Remarks	MCOIL™ MC series	
	CK, CKS, LK Series Measuring frequency : Refer to each specification. Measuring equipment /jig : 1608,2125⇒4294A+16092A (or its equivalent) 1005⇒4291A+16193A (or its equivalent) Measuring current : 047~4.7 μH ⇒1mArms , 5.6~33 μH ⇒0.1mArms	
	CKP, MCOIL™ MC Series Measuring frequency : 1MHz Measuring equipment : 4285A (or its equivalent)	
	HK0603, HK1005, AQ Series Measuring frequency : 100MHz Measuring equipment /jig : HK0603⇒ E4991A+16197A (or its equivalent) , AQ105⇒4291A+16197A (or its equivalent) HK1005⇒ 4291A+16193A (or its equivalent)	
	HK1608, HK2125 Series Measuring frequency : ~100nH⇒100MHz , 120nH~⇒50MHz Measuring equipment /jig : 4291A+16092A (or its equivalent)	
	HKQ Series Measuring frequency : 500MHz Measuring equipment /jig : E4991A+16197A (or its equivalent)	

▶ This catalog contains the typical specification only due to the limitation of space. When you consider the purchase of our products, please check our specification.
For details of each product (characteristics graph, reliability information, precautions for use, and so on), see our Web site (<http://www.ty-top.com/>).

6. Q		
Specified Value	CK series	—
	CKS series	
	CKP series	
	LK series	Refer to each specification.
	HK0603, HK1005	
	HK1608, HK2125	
	HKQ0603	
	AQ105	
MCOIL™ MC series	—	
Test Methods and Remarks	LK Series	
	Measuring frequency : Refer to each specification.	
	Measuring equipment /jig : 1608,2125⇒4294A+16092A(or its equivalent) 1005⇒4291A+16193A(or its equivalent)	
	Measuring current : 047~4.7 μH ⇒1mArms 、 5.6~33 μH ⇒0.1mArms	
	HK0603, HK1005, AQ Series	
	Measuring frequency : 100MHz	
	Measuring equipment /jig : HK0603⇒E4991A+16197A(or its equivalent) , AQ105⇒4291A+16197A(or its equivalent) HK1005⇒4291A+16193A(or its equivalent)	
	HK1608, HK2125 Series	
	Measuring frequency : ~100nH⇒100MHz 、 120nH~⇒50MHz	
	Measuring equipment /jig : 4291A+16092A(or its equivalent)	
Specified Value	BK series	Refer to each specification.
	BKH series	
	BKP series	
	MCF series	
	CK series	
	CKS series	
	CKP series	
	LK series	
	HK0603, HK1005	
	HK1608, HK2125	
HKQ0603		
AQ105		
MCOIL™ MC series		
Test Methods and Remarks	Measuring equipment : IWATSU VOAC7512, HIOKI RM3545 (or its equivalent)	
7. DC Resistance		
Specified Value	BK series	Refer to each specification.
	BKH series	
	BKP series	
	MCF series	
	CK series	
	CKS series	
	CKP series	
	LK series	
	HK0603, HK1005	
	HK1608, HK2125	
	HKQ0603	
	AQ105	
	MCOIL™ MC series	
Test Methods and Remarks	Measuring equipment : IWATSU VOAC7512, HIOKI RM3545 (or its equivalent)	
8. Self Resonance Frequency (SRF)		
Specified Value	BK series	—
	BKH series	
	BKP series	
	MCF series	
	CK series	Refer to each specification.
	CKS series	
	CKP series	—
	LK series	Refer to each specification.
	HK0603, HK1005	
	HK1608, HK2125	
	HKQ0603	
	AQ105	
	MCOIL™ MC series	—
Test Methods and Remarks	LK, CK Series : Measuring equipment : 4195A(or its equivalent) Measuring jig : 16092A(or its equivalent) HK, HKQ, AQ Series : Measuring equipment : 8719C(or its equivalent)	

▶ This catalog contains the typical specification only due to the limitation of space. When you consider the purchase of our products, please check our specification.
For details of each product (characteristics graph, reliability information, precautions for use, and so on), see our Web site (<http://www.ty-top.com/>).

9. Resistance to Flexure of Substrate		
Specified Value	BK series	No mechanical damage.
	BKH series	
	BKP series	
	MCF series	
	CK series	
	CKS series	
	CKP series	
	LK series	
	HK0603, HK1005	
	HK1608, HK2125	
	HKQ0603	
	AQ105	
MCOIL™ MC series		
Test Methods and Remarks	Warp : 2mm (BK Series, BKP, BKH1005, CK, CKS, CKP, LK, HK, HKQ0603S, HKQ0603U, AQ Series, MCF1210, MC Series) : 1mm (BKH0603, MCF Series without 1210 size.)	<p>(Unit: mm)</p>
	Testing board : glass epoxy-resin substrate Thickness : 0.8mm	

10. Solderability		
Specified Value	BK series	At least 90% of terminal electrode is covered by new solder.
	BKH series	
	BKP series	
	MCF series	
	CK series	
	CKS series	
	CKP series	
	LK series	
	HK0603, HK1005	
	HK1608, HK2125	
	HKQ0603	
	AQ105	
MCOIL™ MC series		
Test Methods and Remarks	Solder temperature : 230 ± 5°C (JIS Z 3282 H60A or H63A)	
	Solder temperature : 245 ± 3°C (Sn/3.0Ag/0.5Cu)	
	Duration : 4 ± 1 sec.	

11. Resistance to Soldering		
Specified Value	BK series	Appearance: No significant abnormality Impedance change: Within $\pm 30\%$
	BKH series	
	BKP series	
	MCF series	Appearance: No significant abnormality Impedance change: Within $\pm 20\%$
	CK series	Appearance: No significant abnormality Inductance change: R10~4R7 \Rightarrow Within $\pm 10\%$ 、6R8~100 \Rightarrow Within $\pm 15\%$
	CKS series	Appearance: No significant abnormality Inductance change: Within $\pm 20\%$
	CKP series	Appearance: No significant abnormality Inductance change: Within $\pm 30\%$
	LK series	Appearance: No significant abnormality Inductance change: 1005 \Rightarrow Within $\pm 15\%$ 1608,2125 \Rightarrow 47N~4R7: Within $\pm 10\%$ 5R6~330: Within $\pm 15\%$
	HK0603, HK1005	Appearance: No significant abnormality Inductance change: Within $\pm 5\%$
	HK1608, HK2125	
	HKQ0603	
	AQ105	
MCOIL™ MC series	Appearance: No significant abnormality Inductance change: Within $\pm 10\%$	
Test Methods and Remarks	Solder temperature : $260 \pm 5^\circ\text{C}$ Duration : 10 ± 0.5 sec. Preheating temperature : 150 to 180°C Preheating time : 3 min. Flux : Immersion into methanol solution with colophony for 3 to 5 sec. Recovery : 2 to 3 hrs of recovery under the standard condition after the test. (See Note 1)	

(Note 1) When there are questions concerning measurement result; measurement shall be made after 48 ± 2 hrs of recovery under the standard condition.

12. Thermal Shock																	
Specified Value	BK series	Appearance: No significant abnormality Impedance change: Within $\pm 30\%$															
	BKH series																
	BKP series																
	MCF series	Appearance: No significant abnormality Impedance change: Within $\pm 20\%$															
	CK series	Appearance: No significant abnormality Inductance change: Within $\pm 20\%$															
	CKS series																
	CKP series	Appearance: No significant abnormality Inductance change: Within $\pm 30\%$															
	LK series	Appearance: No significant abnormality Inductance change: Within $\pm 10\%$ Q change: Within $\pm 30\%$															
	HK0603, HK1005	Appearance: No significant abnormality Inductance change: Within $\pm 10\%$ Q change: Within $\pm 20\%$															
	HK1608, HK2125																
	HKQ0603																
	AQ105																
MCOIL™ MC series	Appearance: No significant abnormality Inductance change: Within $\pm 10\%$																
Test Methods and Remarks	Conditions for 1 cycle <table border="1" style="margin-left: 20px;"> <thead> <tr> <th>Step</th> <th>temperature ($^\circ\text{C}$)</th> <th>time (min.)</th> </tr> </thead> <tbody> <tr> <td>1</td> <td>Minimum operating temperature $+0/-3$</td> <td>30 ± 3</td> </tr> <tr> <td>2</td> <td>Room temperature</td> <td>$2 \sim 3$</td> </tr> <tr> <td>3</td> <td>Maximum operating temperature $+3/-0$</td> <td>30 ± 3</td> </tr> <tr> <td>4</td> <td>Room temperature</td> <td>$2 \sim 3$</td> </tr> </tbody> </table> Number of cycles: 5 Recovery: 2 to 3 hrs of recovery under the standard condition after the test. (See Note 1)		Step	temperature ($^\circ\text{C}$)	time (min.)	1	Minimum operating temperature $+0/-3$	30 ± 3	2	Room temperature	$2 \sim 3$	3	Maximum operating temperature $+3/-0$	30 ± 3	4	Room temperature	$2 \sim 3$
Step	temperature ($^\circ\text{C}$)	time (min.)															
1	Minimum operating temperature $+0/-3$	30 ± 3															
2	Room temperature	$2 \sim 3$															
3	Maximum operating temperature $+3/-0$	30 ± 3															
4	Room temperature	$2 \sim 3$															

(Note 1) When there are questions concerning measurement result; measurement shall be made after 48 ± 2 hrs of recovery under the standard condition.

13. Damp Heat (Steady state)		
Specified Value	BK series	Appearance: No significant abnormality Impedance change: Within $\pm 30\%$
	BKH series	
	BKP series	
	MCF series	Appearance: No significant abnormality Impedance change: Within $\pm 20\%$
	CK series	Appearance: No significant abnormality Inductance change: Within $\pm 20\%$
	CKS series	
	CKP series	Appearance: No significant abnormality Inductance change: Within $\pm 30\%$
	LK series	Appearance: No significant abnormality Inductance change: 1005,1608 \Rightarrow Within $\pm 10\%$ 2125 \Rightarrow Within $\pm 20\%$ Q change: Within $\pm 30\%$
	HK0603, HK1005	Appearance: No significant abnormality Inductance change: Within $\pm 10\%$ Q change: Within $\pm 20\%$
	HK1608, HK2125	
	HKQ0603	
	AQ105	
	MCOIL™ MC series	Appearance: No significant abnormality Inductance change: Within $\pm 10\%$
Test Methods and Remarks	BK, BKP, BKH, LK, CK, CKS, CKP, MCF Series: Temperature : $40 \pm 2^\circ\text{C}$ Humidity : 90 to 95%RH Duration : 500 +24/-0 hrs Recovery : 2 to 3 hrs of recovery under the standard condition after the removal from test chamber. (See Note 1)	
	HK, HKQ, AQ, MCOIL™ MC series: Temperature : $60 \pm 2^\circ\text{C}$ Humidity : 90 to 95%RH Duration : 500 +24/-0 hrs Recovery : 2 to 3 hrs of recovery under the standard condition after the removal from test chamber. (See Note 1)	

(Note 1) When there are questions concerning measurement result; measurement shall be made after 48 ± 2 hrs of recovery under the standard condition.

14. Loading under Damp Heat

Specified Value	BK series	Appearance: No significant abnormality Impedance change: Within $\pm 30\%$
	BKH series	
	BKP series	
	MCF series	—
	CK series	Appearance: No significant abnormality
	CKS series	Inductance change: Within $\pm 20\%$
	CKP series	Appearance: No significant abnormality Inductance change: Within $\pm 30\%$
	LK series	Appearance: No significant abnormality Inductance change: 1005 \Rightarrow Within $\pm 10\%$ 1608 \Rightarrow 0.047 ~ 12.0 μH : Within $\pm 10\%$ 15.0 ~ 33.0 μH : Within $\pm 15\%$ 2125 \Rightarrow Within $\pm 20\%$ Q change: Within $\pm 30\%$
	HK0603, HK1005	Appearance: No significant abnormality Inductance change: Within $\pm 10\%$ Q change: Within $\pm 20\%$
	HK1608, HK2125	
	HKQ0603	
	AQ105	
MCOIL™ MC series※	Appearance: No significant abnormality Inductance change: Within $\pm 10\%$	
Test Methods and Remarks	BK, BKP, BKH, LK, CK, CKS, CKP Series: Temperature : $40 \pm 2^\circ\text{C}$ Humidity : 90 to 95%RH Applied current : Rated current Duration : 500 +24/-0 hrs Recovery : 2 to 3 hrs of recovery under the standard condition after the removal from test chamber. (See Note 1)	
	HK, HKQ, AQ, MCOIL™ MC Series: Temperature : $60 \pm 2^\circ\text{C}$ Humidity : 90 to 95%RH Applied current : Rated current ※MC series ; I_{dc2max} Duration : 500 +24/-0 hrs Recovery : 2 to 3 hrs of recovery under the standard condition after the removal from test chamber. (See Note 1)	

Note on standard condition: "standard condition" referred to herein is defined as follows:

5 to 35°C of temperature, 45 to 85% relative humidity, and 86 to 106kPa of air pressure.

When there are questions concerning measurement results:

In order to provide correlation data, the test shall be conducted under condition of $20 \pm 2^\circ\text{C}$ of temperature, 60 to 70% relative humidity, and 86 to 106kPa of air pressure.

Unless otherwise specified, all the tests are conducted under the "standard condition."

(Note 1) Measurement shall be made after 48 ± 2 hrs of recovery under the standard condition.

15. Loading at High Temperature		
Specified Value	BK series	Appearance: No significant abnormality Impedance change: Within $\pm 30\%$
	BKH series	
	BKP series	
	MCF series	Appearance: No significant abnormality Impedance change: Within $\pm 20\%$
	CK series	Appearance: No significant abnormality Inductance change: Within $\pm 20\%$
	CKS series	
	CKP series	Appearance: No significant abnormality Inductance change: Within $\pm 30\%$
	LK series	Appearance: No significant abnormality Inductance change: 1005 \Rightarrow Within $\pm 10\%$ 1608 \Rightarrow 0.047 \sim 12.0 μ H: Within $\pm 10\%$ 15.0 \sim 33.0 μ H: Within $\pm 15\%$ 2125 \Rightarrow Within $\pm 20\%$ Q change: Within $\pm 30\%$
	HK0603, HK1005	Appearance: No significant abnormality Inductance change: Within $\pm 10\%$ Q change: Within $\pm 20\%$
	HK1608, HK2125	
	HKQ0603	
	AQ105	
	MCOIL™ MC series※	Appearance: No significant abnormality Inductance change: Within $\pm 10\%$
Test Methods and Remarks	Temperature : Maximum operating temperature Applied current : Rated current ※MC series ; Idc2max Duration : 500 +24/-0 hrs Recovery : 2 to 3 hrs of recovery under the standard condition after the removal from test chamber. (See Note 1)	

Note on standard condition: "standard condition" referred to herein is defined as follows:
5 to 35°C of temperature, 45 to 85% relative humidity, and 86 to 106kPa of air pressure.

When there are questions concerning measurement results:

In order to provide correlation data, the test shall be conducted under condition of $20\pm 2^\circ\text{C}$ of temperature, 60 to 70% relative humidity, and 86 to 106kPa of air pressure. Unless otherwise specified, all the tests are conducted under the "standard condition."

(Note 1) Measurement shall be made after 48 ± 2 hrs of recovery under the standard condition.

Precautions on the use of Multilayer chip inductors

Multilayer chip inductors for high frequency, Multilayer chip bead inductors

Multilayer common mode choke coils (MC series F type)

■ PRECAUTIONS

1. Circuit Design

- Precautions**
- ◆ Verification of operating environment, electrical rating and performance
 1. A malfunction in medical equipment, spacecraft, nuclear reactors, etc. may cause serious harm to human life or have severe social ramifications.
As such, any inductors to be used in such equipment may require higher safety and/or reliability considerations and should be clearly differentiated from components used in general purpose applications.
 - ◆ Operating Current (Verification of Rated current)
 1. The operating current including inrush current for inductors must always be lower than their rated values.
 2. Do not apply current in excess of the rated value because the inductance may be reduced due to the magnetic saturation effect.

2. PCB Design

- Precautions**
- ◆ Pattern configurations (Design of Land-patterns)
 1. When inductors are mounted on a PCB, the size of land patterns and the amount of solder used (size of fillet) can directly affect inductor performance.
Therefore, the following items must be carefully considered in the design of solder land patterns:
 - (1) The amount of solder applied can affect the ability of chips to withstand mechanical stresses which may lead to breaking or cracking. Therefore, when designing land-patterns it is necessary to consider the appropriate size and configuration of the solder pads which in turn determines the amount of solder necessary to form the fillets.
 - (2) When more than one part is jointly soldered onto the same land or pad, the pad must be designed so that each component's soldering point is separated by solder-resist.
 - (3) The larger size of land patterns and amount of solder, the smaller Q value after mounting on PCB. It makes higher the Q value to design land patterns smaller than terminal electrode of chips.
 - ◆ Pattern configurations (Inductor layout on panelized [breakaway] PC boards)
 1. After inductors have been mounted on the boards, chips can be subjected to mechanical stresses in subsequent manufacturing processes (PCB cutting, board inspection, mounting of additional parts, assembly into the chassis, wave soldering the reflow soldered boards etc.) For this reason, planning pattern configurations and the position of SMD inductors should be carefully performed to minimize stress.

- Technical considerations**
- ◆ Pattern configurations (Design of Land-patterns)
 1. The following diagrams and tables show some examples of recommended patterns to prevent excessive solder amounts (larger fillets which extend above the component end terminations). Examples of improper pattern designs are also shown.
 - (1) Recommended land dimensions for a typical chip inductor land patterns for PCBs

● Recommended land dimensions for Multilayer inductor
Wave-soldering (Unit: mm)

Type	1608	2012	2125	2016	2520	3216
Size	L	1.6	2.0	2.0	2.5	3.2
	W	0.8	1.25	1.25	1.6	2.0
A	0.8~1.0	1.0~1.4	1.0~1.4	1.0~1.4	1.0~1.4	1.8~2.5
B	0.5~0.8	0.8~1.5	0.8~1.5	0.8~1.5	0.6~1.0	0.8~1.7
C	0.6~0.8	0.9~1.2	0.9~1.2	1.3~1.6	1.6~2.0	1.2~1.6

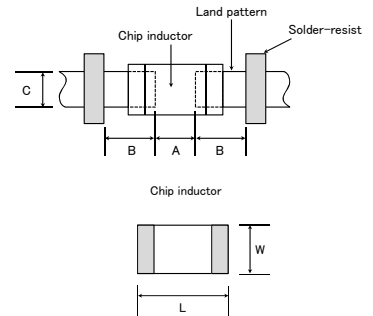

Reflow-soldering (Unit: mm)

Type	0603	1005	105	1608	2012	2125	2016	2520	3216
Size	L	0.6	1.0	1.0	1.6	2.0	2.0	2.5	3.2
	W	0.3	0.5	0.6	0.8	1.25	1.25	1.6	2.0
A	0.20~0.30	0.45~0.55	0.50~0.55	0.8~1.0	0.8~1.2	0.8~1.2	0.8~1.2	1.0~1.4	1.8~2.5
B	0.20~0.30	0.40~0.50	0.30~0.40	0.6~0.8	0.8~1.2	0.8~1.2	0.8~1.2	0.6~1.0	0.6~1.5
C	0.25~0.40	0.45~0.55	0.60~0.70	0.6~0.8	0.9~1.6	0.9~1.6	1.2~2.0	1.8~2.2	1.2~2.0

● Recommended land dimension for Array type
(Unit: mm)

Type	2010	3216	
Size	L	2.0	3.2
	W	1.0	1.6
a	0.5~0.6	0.7~0.9	
b	0.5~0.6	0.8~1.0	
c	0.2~0.3	0.4~0.5	
d	0.5	0.8	

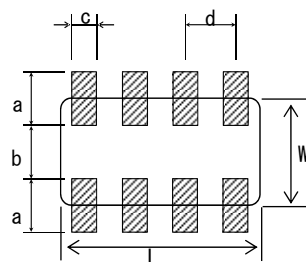

▶ This catalog contains the typical specification only due to the limitation of space. When you consider the purchase of our products, please check our specification. For details of each product (characteristics graph, reliability information, precautions for use, and so on), see our Web site (<http://www.ty-top.com/>).

● Recommended land dimension for Multilayer common mode choke coil
(Unit: mm)

Type	0605	0806	
Size	L	0.65	0.85
	W	0.50	0.65
a	0.27~0.30	0.25~0.35	
b	0.17~0.20	0.25~0.35	
c	0.20~0.26	0.25~0.35	
d	0.4	0.5	

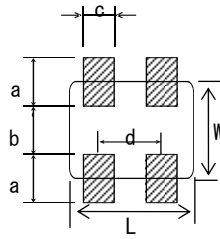

(Unit: mm)

Type	1210	
Size	L	1.0
	W	1.25
a	0.45~0.55	
b	0.7~0.8	
c	0.25~0.35	
d	0.55	

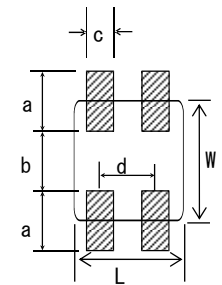

(2) Examples of good and bad solder application

Item	Not recommended	Recommended
Mixed mounting of SMD and leaded components		
Component placement close to the chassis		
Hand-soldering of leaded components near mounted components		
Horizontal component placement		

◆ Pattern configurations (Inductor layout on panelized [breakaway] PC boards)

1-1. The following are examples of good and bad inductor layout; SMD inductors should be located to minimize any possible mechanical stresses from board warp or deflection.

Item	Not recommended	Recommended
Deflection of the board		 Position the component at a right angle to the direction of the mechanical stresses that are anticipated.

1-2. To layout the inductors for the breakaway PC board, it should be noted that the amount of mechanical stresses given will vary depending on inductor layout.

An example below should be counted for better design.

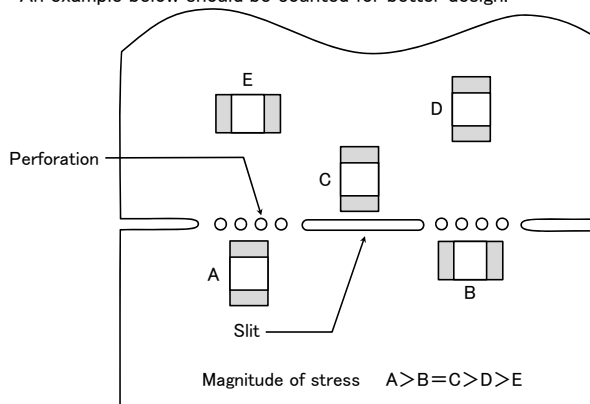

1-3. When breaking PC boards along their perforations, the amount of mechanical stress on the inductors can vary according to the method used. The following methods are listed in order from least stressful to most stressful: push-back, slit, V-grooving, and perforation. Thus, any ideal SMD inductor layout must also consider the PCB splitting procedure.

3. Considerations for automatic placement

Precautions

- ◆ Adjustment of mounting machine
 1. Excessive impact load should not be imposed on the inductors when mounting onto the PC boards.
 2. The maintenance and inspection of the mounter should be conducted periodically.
- ◆ Selection of Adhesives
 1. Mounting inductors with adhesives in preliminary assembly, before the soldering stage, may lead to degraded inductor characteristics unless the following factors are appropriately checked; the size of land patterns, type of adhesive, amount applied, hardening temperature and hardening period. Therefore, it is imperative to consult the manufacturer of the adhesives on proper usage and amounts of adhesive to use.

Technical considerations

- ◆ Adjustment of mounting machine
 1. If the lower limit of the pick-up nozzle is low, too much force may be imposed on the inductors, causing damage. To avoid this, the following points should be considered before lowering the pick-up nozzle:
 - (1) The lower limit of the pick-up nozzle should be adjusted to the surface level of the PC board after correcting for deflection of the board.
 - (2) The pick-up pressure should be adjusted between 1 and 3N static loads.
 - (3) To reduce the amount of deflection of the board caused by impact of the pick-up nozzle, supporting pins or back-up pins should be used under the PC board. The following diagrams show some typical examples of good pick-up nozzle placement:

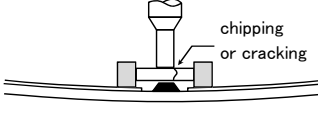
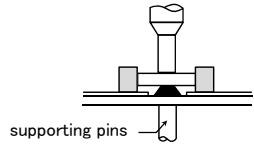
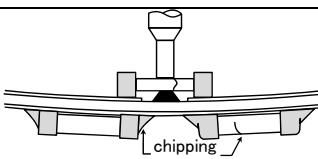
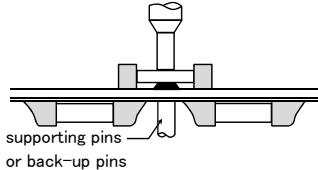
Item	Improper method	Proper method
Single-sided mounting		
Double-sided mounting		

2. As the alignment pin wears out, adjustment of the nozzle height can cause chipping or cracking of the inductors because of mechanical impact on the inductors. To avoid this, the monitoring of the width between the alignment pin in the stopped position, and maintenance, inspection and replacement of the pin should be conducted periodically.
- ◆ Selection of Adhesives
 1. Some adhesives may cause reduced insulation resistance. The difference between the shrinkage percentage of the adhesive and that of the inductors may result in stresses on the inductors and lead to cracking. Moreover, too little or too much adhesive applied to the board may adversely affect component placement, so the following precautions should be noted in the application of adhesives.
 - (1) Required adhesive characteristics
 - a. The adhesive should be strong enough to hold parts on the board during the mounting & solder process.
 - b. The adhesive should have sufficient strength at high temperatures.
 - c. The adhesive should have good coating and thickness consistency.
 - d. The adhesive should be used during its prescribed shelf life.
 - e. The adhesive should harden rapidly.
 - f. The adhesive must not be contaminated.
 - g. The adhesive should have excellent insulation characteristics.
 - h. The adhesive should not be toxic and have no emission of toxic gasses.
 - (2) When using adhesives to mount inductors on a PCB, inappropriate amounts of adhesive on the board may adversely affect component placement. Too little adhesive may cause the inductors to fall off the board during the solder process. Too much adhesive may cause defective soldering due excessive flow of adhesive on to the land or solder pad.

[Recommended conditions]

Figure	0805 case sizes as examples
a	0.3mm min
b	100~120 μm
c	Area with no adhesive

Amount of adhesives

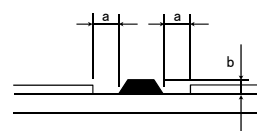

After inductors are bonded

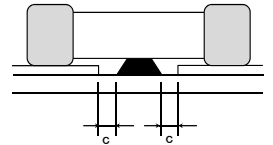

Precautions

◆ Selection of Flux

- Since flux may have a significant effect on the performance of inductors, it is necessary to verify the following conditions prior to use;
 - Flux used should be with less than or equal to 0.1 wt% (Chlorine conversion method) of halogenated content. Flux having a strong acidity content should not be applied.
 - When soldering inductors on the board, the amount of flux applied should be controlled at the optimum level.
 - When using water-soluble flux, special care should be taken to properly clean the boards.

◆ Soldering

- Temperature, time, amount of solder, etc. are specified in accordance with the following recommended conditions, and please contact us about peak temperature when you use lead-free paste.

Technical considerations

◆ Selection of Flux

- When too much halogenated substance (Chlorine, etc.) content is used to activate the flux, or highly acidic flux is used, an excessive amount of residue after soldering may lead to corrosion of the terminal electrodes or degradation of insulation resistance on the surface of the Inductor.
- Flux is used to increase solderability in flow soldering, but if too much is applied, a large amount of flux gas may be emitted and may detrimentally affect solderability. To minimize the amount of flux applied, it is recommended to use a flux-bubbling system.
- Since the residue of water-soluble flux is easily dissolved by water content in the air, the residue on the surface of Inductor in high humidity conditions may cause a degradation of insulation resistance and therefore affect the reliability of the components. The cleaning methods and the capability of the machines used should also be considered carefully when selecting water-soluble flux.

◆ Soldering

1-1. Preheating when soldering

Preheating: Inductors shall be preheated sufficiently, and the temperature difference between the inductors and solder shall be within 130° C.

Cooling: The temperature difference between the components and cleaning process should not be greater than 100°C.

Inductors are susceptible to thermal shock when exposed to rapid or concentrated heating or rapid cooling. Therefore, the soldering process must be conducted with a great care so as to prevent malfunction of the components due to excessive thermal shock.

[Reflow soldering]

【Recommended condition for Pb-free soldering】

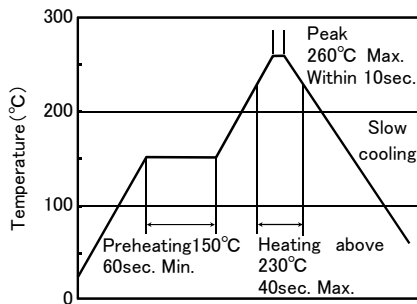

Caution

- Solder (fillet) should wet up to 1/2 to 1/3 of the thickness of an inductor ideally as shown below:

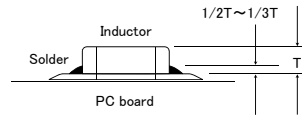

- Because excessive dwell time can detrimentally affect solderability, soldering duration shall be kept as close to recommended time as possible.
- The allowable number of reflow soldering is two (2) times.

[Wave soldering]

【Recommended condition for Pb-free soldering】

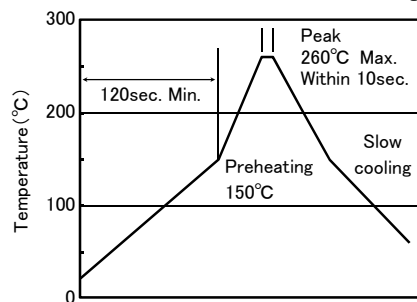

Caution

- Make sure the inductors are preheated sufficiently.
- The temperature difference between the inductor and melted solder should be within 130°C.
- Cooling after soldering should be as gradual as possible.
- The allowable number of wave soldering is one (1) time.
- Wave soldering must not be applied to the inductors designated as for reflow soldering only.

[Hand soldering]

【Recommended condition for Pb-free soldering】

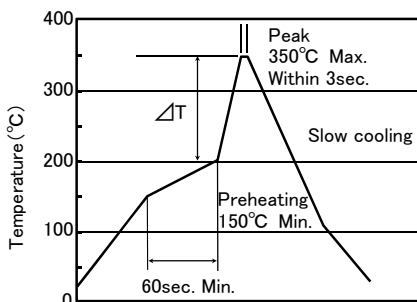

Caution

- It is recommended to use a 20W soldering iron with a maximum tip diameter of 1.0 mm.
- The soldering iron shall not directly touch inductors
- The allowable number of hand soldering is one (1) time

5. Cleaning							
Precautions	<p>◆Cleaning conditions</p> <ol style="list-style-type: none"> When cleaning the PC board after the Inductors are all mounted, select the appropriate cleaning solution according to the type of flux used and purpose of the cleaning (e.g. to remove soldering flux or other materials from the production process.) Cleaning conditions should be determined after verifying, through a test run, that the cleaning process does not affect the inductor's characteristics. 						
Technical considerations	<p>◆Cleaning conditions</p> <ol style="list-style-type: none"> The use of inappropriate solutions can cause foreign substances such as flux residue to adhere to the inductor, resulting in a degradation of the inductor's electrical properties (especially insulation resistance). Inappropriate cleaning conditions (insufficient or excessive cleaning) may detrimentally affect the performance of the inductors. In the case of ultrasonic cleaning, too much power output can cause excessive vibration of the PC board which may lead to the cracking of the inductor or the soldered portion, or decrease the terminal electrodes' strength. Therefore, the following conditions should be carefully checked; <table border="0"> <tr> <td>Ultrasonic output</td> <td>20W/ℓ or less</td> </tr> <tr> <td>Ultrasonic frequency</td> <td>40kHz or less</td> </tr> <tr> <td>Ultrasonic washing period</td> <td>5 min. or less</td> </tr> </table>	Ultrasonic output	20W/ℓ or less	Ultrasonic frequency	40kHz or less	Ultrasonic washing period	5 min. or less
Ultrasonic output	20W/ℓ or less						
Ultrasonic frequency	40kHz or less						
Ultrasonic washing period	5 min. or less						

6. Resin coating and mold	
Precautions	<ol style="list-style-type: none"> With some type of resins a decomposition gas or chemical reaction vapor may remain inside the resin during the hardening period or while left under normal storage conditions resulting in the deterioration of the inductor's performance. Thermal expansion and thermal shrinkage characteristics of resins may lead to the deterioration of inductors' performance. When a resin hardening temperature is higher than inductor operating temperature, the stresses generated by the excessive heat may lead to damage in inductors.

7. Handling	
Precautions	<p>◆Breakaway PC boards (splitting along perforations)</p> <ol style="list-style-type: none"> When splitting the PC board after mounting inductors and other components, care is required so as not to give any stresses of deflection or twisting to the board. Board separation should not be done manually, but by using the appropriate devices. <p>◆General handling precautions</p> <ul style="list-style-type: none"> Always wear static control bands to protect against ESD. Keep the inductors away from all magnets and magnetic objects. Use non-magnetic tweezers when handling inductors. Any devices used with the inductors (soldering irons, measuring instruments) should be properly grounded. Keep bare hands and metal products (i.e., metal desk) away from inductor electrodes or conductive areas that lead to chip electrodes. Keep inductors away from items that generate magnetic fields such as speakers or coils. <p>◆Mechanical considerations</p> <p>Be careful not to subject the inductors to excessive mechanical shocks.</p> <ol style="list-style-type: none"> If inductors are dropped on the floor or a hard surface they should not be used. When handling the mounted boards, be careful that the mounted components do not come in contact with or bump against other boards or components.

8. Storage conditions	
Precautions	<p>◆Storage</p> <p>To maintain the solderability of terminal electrodes and to keep the packaging material in good condition, care must be taken to control temperature and humidity in the storage area. Humidity should especially be kept as low as possible.</p> <ul style="list-style-type: none"> Recommended conditions Ambient temperature: 30°C or below Humidity: 70% RH or below <p>The ambient temperature must be kept below 40°C. Even under ideal storage conditions, solderability of inductor is deteriorated as time passes, so inductors should be used within 6 months from the time of delivery.</p> <ul style="list-style-type: none"> Inductor should be kept where no chlorine or sulfur exists in the air.
Technical considerations	<p>◆Storage</p> <p>If the parts are stocked in a high temperature and humidity environment, problems such as reduced solderability caused by oxidation of terminal electrodes and deterioration of taping/package materials may take place. For this reason, components should be used within 6 months from the time of delivery. If exceeding the above period, please check solderability before using the inductors.</p>

► This catalog contains the typical specification only due to the limitation of space. When you consider the purchase of our products, please check our specification. For details of each product (characteristics graph, reliability information, precautions for use, and so on), see our Web site (<http://www.ty-top.com/>).