

REV	LOCATIONS	DESCRIPTION	DATE	REVISER	APPD

Electrical

Current Rating: 5.0A AC(rms)/DC
Voltage Rating: 250V AC(rms)/DC
Contact Resistance: 10 m Ω Max
Insulation Resistance: 1000 M Ω MIN
Withstanding Voltage: 1500V AC r.m.s
Temperature Range—Operating: -40°C ~ +105°C

Material and Plating

Housing: PA66(UL 94V-0)
Contact Pin: Brass
Plating: Tin Plated

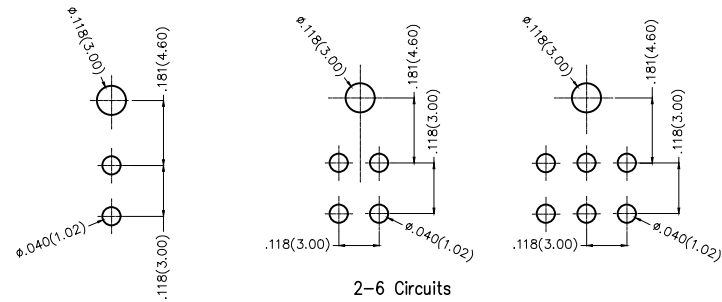
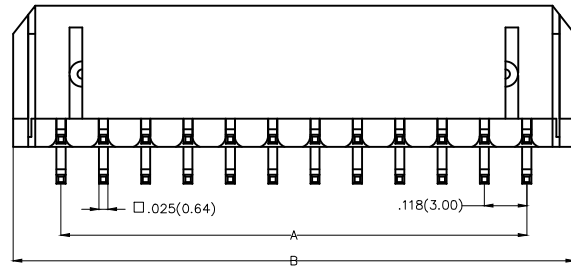
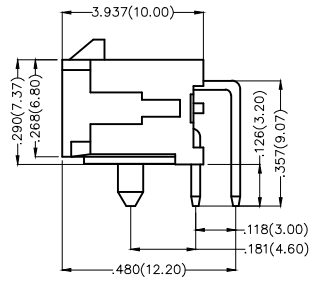
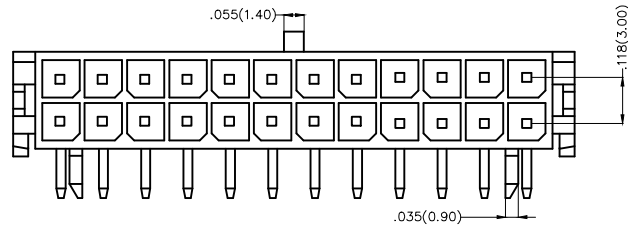

Recommended P.C.Board Layout

Ordering Information

FWF 300 02 — D XX B 2 2 K6 B
1 2 3 4 5 6 7 8 9 10

1 Category FWF—Wafer	2 Series Number 300—Pitch 3.0mm	3 Distinction No. 02	4 Row Option Double Row	5 Circuits XX	6 Entry Angle B—90° Angle
7 Plating 2—Tin Plated	8 Material—Resin 2—PA66	9 Color—Resin K6—Black	10 Packaging B—PE Bag		

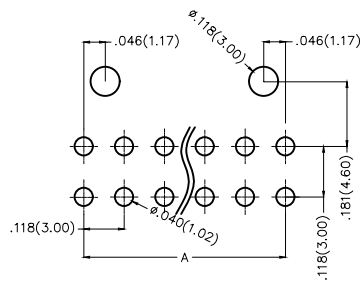

Circuits: 8~20

Recommended P.C.Board Layout

THIRD ANGLE PROJECTION	GENERAL TOLERANCES (UNLESS SPECIFIED)		APPROVE BY FRANK	DATE 01/JUL/13	PART NO. FWF30002—DXXB22K6B	ITEM NO. FWF30002	 Leader Of Industry	
	DESIGN UNITS Inch (metric)	X.±.012(0.30) X.X±.008(0.20) X.XX±.006(0.15) X.XXX±.004(0.10)	X.±5° .X°±2° .XX°±1° .XXX°±0.5°	CHECKED BY CHERRY	DATE 01/JUL/13	TITLE Wire to Board (Wafer) Pitch 3.0mm 90° Angled (DIP)		REV 0
SCALE 5:1	SIZE A4	DRAWN BY JACOB		DATE 01/JUL/13	THIS DRAWING CONTAINS INFORMATION THAT IS PROPRIETARY TO TXGA INDUSTRIAL ELECTRONICS(S.Z)CO.,LTD AND SHOULD NOT BE USED WITHOUT WRITTEN PERMISSION			

1 2 3 4 5 6 7 8

REV	LOCATIONS	DESCRIPTION	DATE	REVISER	APPD

A

A

B

B

C

C

D

D



E

E

F

F

Material and Plating : Housing PA66 UL94V-0 , Tin Plated.			
Circuits (n)	Part No.	Dimensions(in/mm)	
		A	B
2	FWF30002-D02B22K6B	—	.264(6.70)
4	FWF30002-D04B22K6B	.118(3.00)	.382(9.70)
6	FWF30002-D06B22K6B	.236(6.00)	.500(12.70)
8	FWF30002-D08B22K6B	.354(9.00)	.618(15.70)
10	FWF30002-D10B22K6B	.472(12.00)	.736(18.70)
12	FWF30002-D12B22K6B	.591(15.00)	.854(21.70)
14	FWF30002-D14B22K6B	.709(18.00)	.969(24.60)
16	FWF30002-D16B22K6B	.827(21.00)	1.091(27.70)
18	FWF30002-D18B22K6B	.945(24.00)	1.209(30.70)
20	FWF30002-D20B22K6B	1.063(27.00)	1.327(33.70)
22	FWF30002-D22B22K6B	1.181(30.00)	1.445(36.70)
24	FWF30002-D24B22K6B	1.299(33.00)	1.563(39.70)

 THIRD ANGLE PROJECTION	GENERAL TOLERANCES (UNLESS SPECIFIED)		APPROVE BY FRANK	DATE 01/JUL/13	PART NO. FWF30002-DXXB22K6B	ITEM NO. FWF30002	 Leader Of Industry	
	X.±.012(0.30)	.X'±5'	CHECKED BY CHERRY	DATE 01/JUL/13	TITLE Wire to Board (Wafer) Pitch 3.0mm 90° Angled (DIP)			REV 0
	DESIGN UNITS Inch (metric)	X.XX±.008(0.20)	.X'±2'	DRAWN BY JACOB	DATE 01/JUL/13	THIS DRAWING CONTAINS INFORMATION THAT IS PROPRIETARY TO TXGA INDUSTRIAL ELECTRONICS(S.Z)CO.,LTD AND SHOULD NOT BE USED WITHOUT WRITTEN PERMISSION		
SCALE 5:1	SIZE A4	X.XXX±.004(0.10)	.XX'±1'					

1 2 3 4 5 6 7 8