

Type SMA series

Key Features

Excellent overall stability

Sn termination on Ni barrier layer

Tight tolerance down to $\pm 0.1\%$

Extremely low TCR down to ± 10 PPM/ $^{\circ}$ C

SMD enabled structure

Lead-free and RoHS compliant



Applications

Industrial

Telecommunication

Medical Equipment

Measurement/Testing Equipment

The SMA series is a metal film precision MELF resistor with an SMD enabled structure, tight tolerance and low TCR.

It comes in two sizes and four power ratings to 1W, is lead free and RoHS compliant.

Standard Electrical Specifications

Size	Power Rating at 70 $^{\circ}$ C	Max. Operating Voltage	Max. Overload Voltage	Resistance Range					TCR (PPM/ $^{\circ}$ C)
				$\pm 0.1\%$	$\pm 0.25\%$	$\pm 0.5\%$	$\pm 1\%$	$\pm 5\%$	
0204	0.25W	200V	400V	10 Ω -20K Ω					± 10
				10 Ω -300K Ω					± 15
				10 Ω -1M Ω			4.02 Ω -4.7M Ω		± 25
				10 Ω -1M Ω	1 Ω -1M Ω	0.2 Ω -10M Ω		± 50	
				-			0.1 Ω -10M Ω		± 100
	Jumper: 2A	0 Ω (<15m Ω)					-		
0207	0.5W	300V	600V	10 Ω -20K Ω					± 10
				10 Ω -300K Ω					± 15
				10 Ω -1M Ω			4.02 Ω -4.7M Ω		± 25
				10 Ω -1M Ω	1 Ω -1M Ω	0.2 Ω -10M Ω		± 50	
				-			0.1 Ω -10M Ω		± 100
	Jumper: 4A	0 Ω (<15m Ω)					-		

High Power Rating Electrical Specifications

Size	Power Rating at 70°C	Max. Operating Voltage	Max. Overload Voltage	Resistance Range					TCR (PPM/°C)
				±0.1%	±0.25%	±0.5%	±1%	±5%	
0204	0.4W	200V	400V	10Ω-100KΩ					±15
				10Ω-1MΩ			4.02Ω-1MΩ		±25
				10Ω-1MΩ	1Ω - 1MΩ		0.2Ω-1MΩ		±50
				-			0.1Ω-1MΩ		±100
0207	1W	350V	700V	10Ω-100KΩ					±15
				10Ω-1MΩ			4.02Ω-1MΩ		±25
				10Ω-1MΩ	1Ω - 1MΩ		0.2Ω-10MΩ		±50
				-			0.1Ω-10MΩ		±100

Operating Voltage= $v(P \cdot R)$ or Max. Operating Voltage listed above, whichever is lower

Overload Voltage= $2.5 \cdot v(P \cdot R)$ or Max. Overload Voltage listed above, whichever is lower.

RCWV(Rated Continuous Working Voltage)= $v(P \cdot R)$ or Max. Operating Voltage whichever is lower.

Operating temperature range - -55°C~155°C

Derating Curve

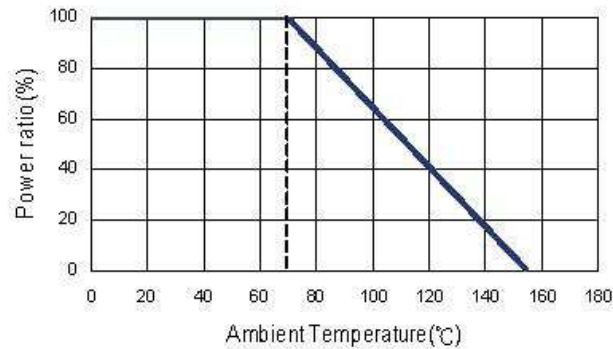

Construction and Dimensions

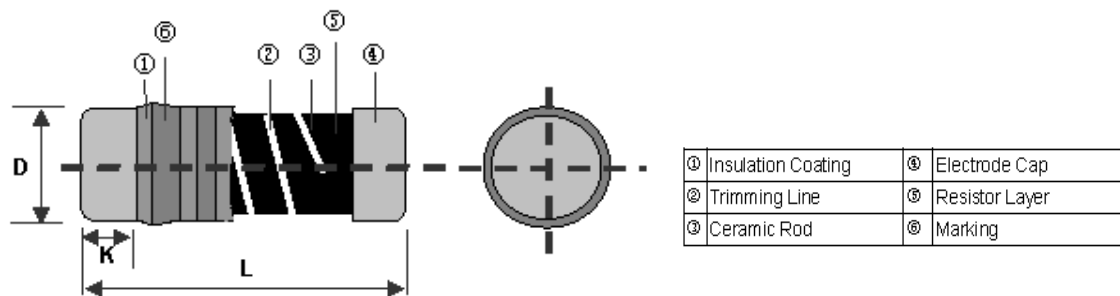

Type	L (mm)	ΦD (mm)	K (mm)	Weight 1,000EA (g)
SMA0204	3.50±0.2	1.40±0.15	0.8±0.1	18.7
SMA0207	5.90±0.2	2.20±0.20	1.3±0.1	80.9

Recommended Land Pattern

Type	A (mm)	B (mm)	C (mm)
SMA0204	1.6	1.2	1.6
SMA0207	3.0	1.7	2.4

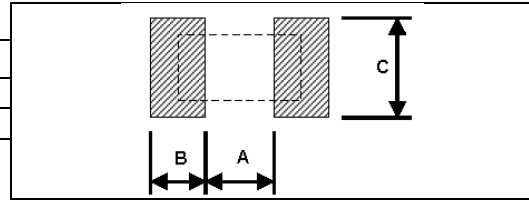

Soldering Condition

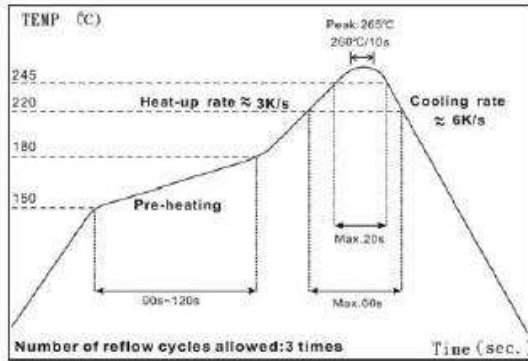

IR Reflow Soldering

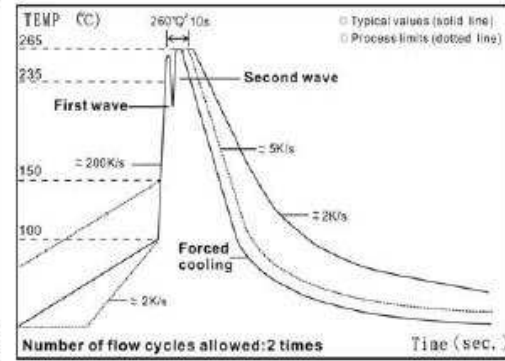

Wave Soldering (Flow Soldering)

- (1) Time of IR reflow soldering at maximum temperature point 260°C : 10s
- (2) Time of wave soldering at maximum temperature point 260°C : 10s
- (3) Time of soldering iron at maximum temperature point 410°C : 5s

Pulse withstanding capacity

The single impulse graph is the result of 50 impulses of rectangular shape applied at one-minute intervals. The limit of acceptance was a shift in resistance of less than 1% from the initial value. The power applied was subject to the restrictions of the maximum permissible impulse voltage graph shown

SMA Series Single Pulse(100 Ohm)

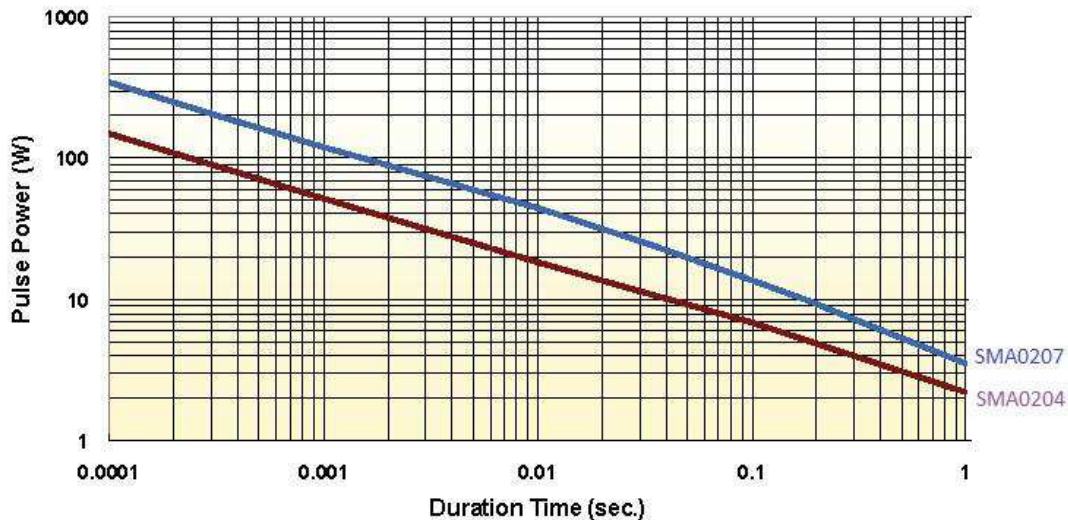

Continuous Pulse

The continuous load graph was obtained by applying repetitive rectangular pulses where the pulse period was adjusted so that the average power dissipated in the resistor was equal to its rated power at 70°C. Again the limit of acceptance was a shift in resistance of less than 1% from the initial value

SMA series Continuous Pulse (100 Ohm)

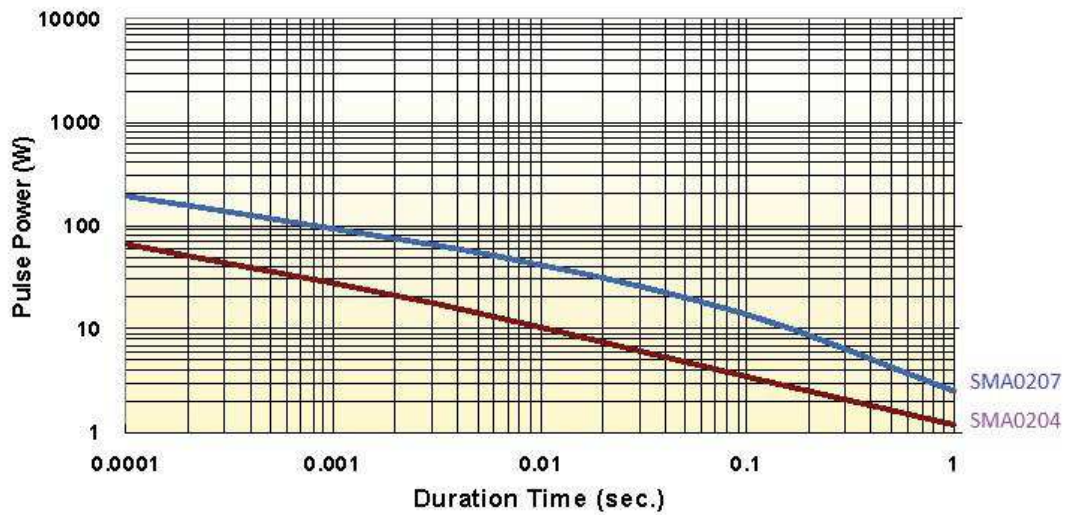

SMA series Pulse Voltage (100 Ohm)

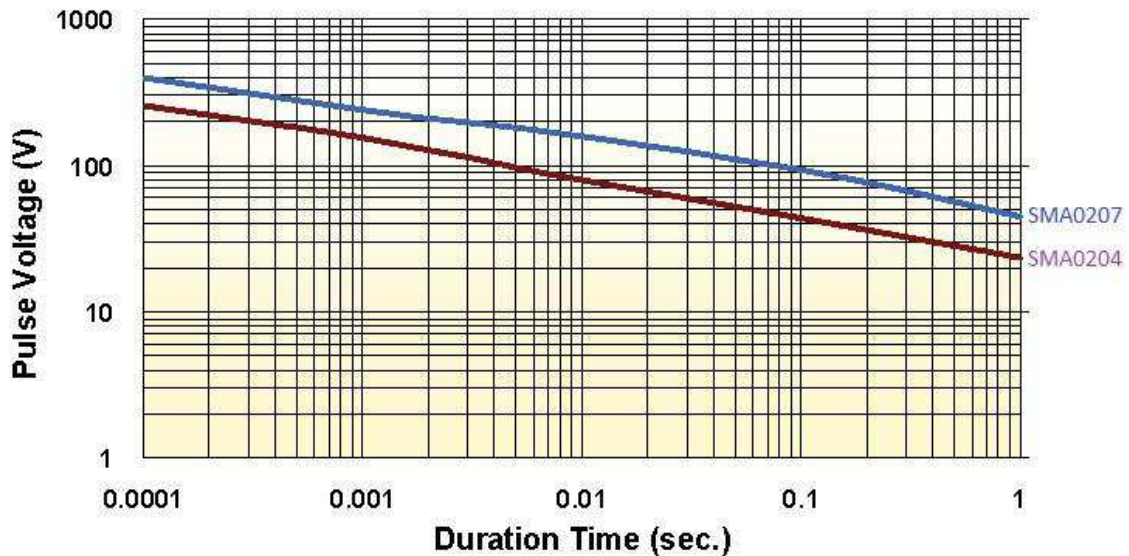

Frequency behaviour

Resistors are designed to function according to ohmic laws. This is basically true of resistors for frequencies up to 100kHz. At higher frequencies, there is an additional contribution to the impedance by an ideal resistor switched in series with a coil and both switched parallel to a capacitor. The values of the capacitance and inductance are mainly determined by the dimensions of the terminations and the conductive path length.

The environment surrounding components has a large influence on the behavior of the component on the printed-circuit board.

Frequency Vs. Impedance

SMA0204

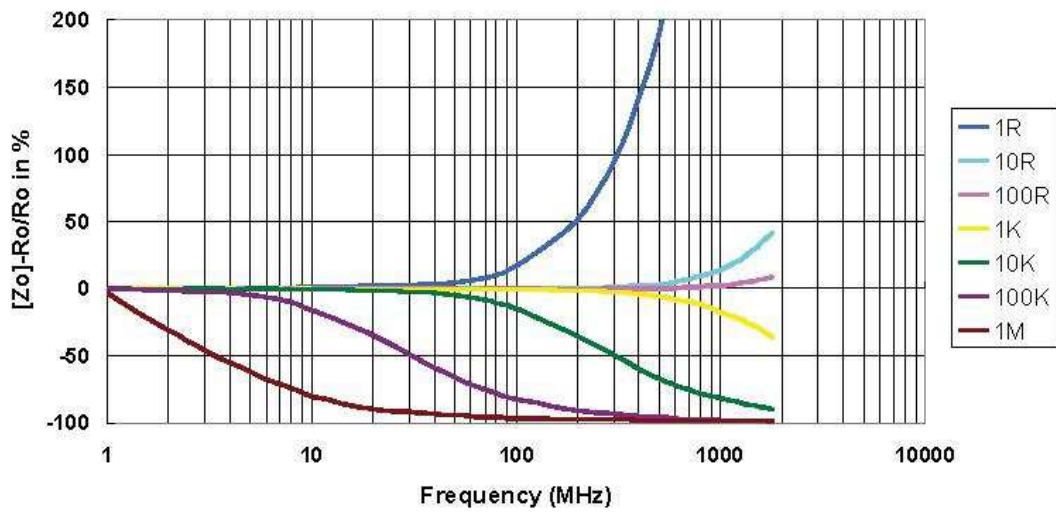

Frequency Vs Phase Angle

SMA0204

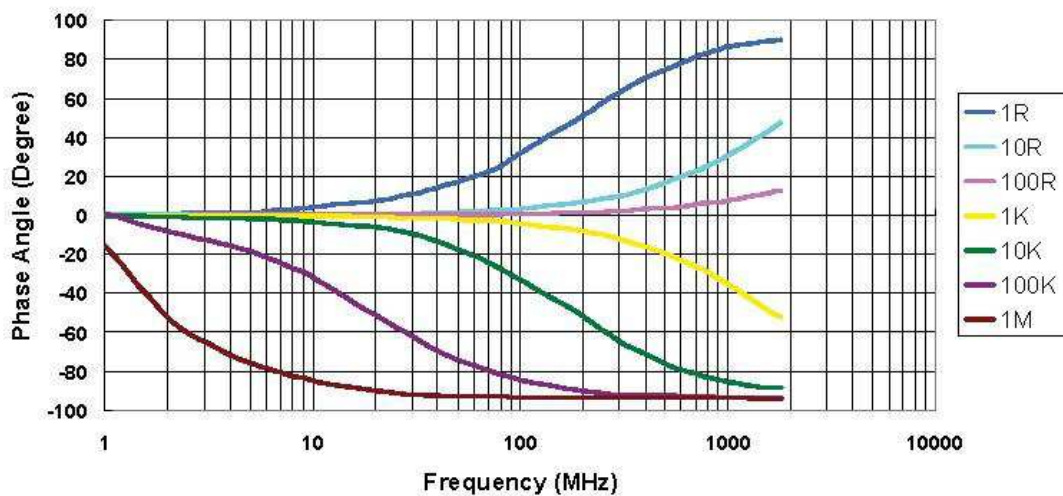

Frequency Vs Impedance

SMA0207

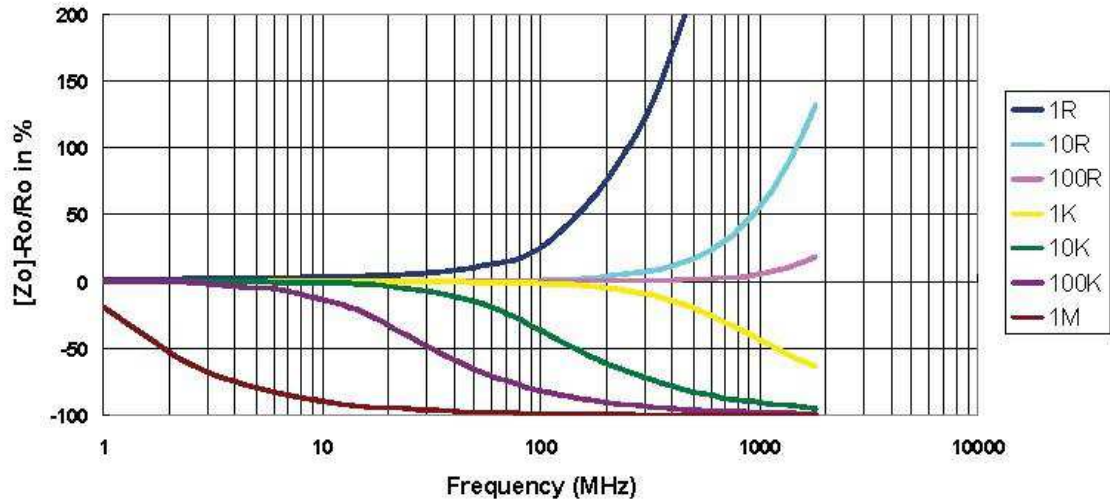

Frequency Vs Phase Angle

SMA0207

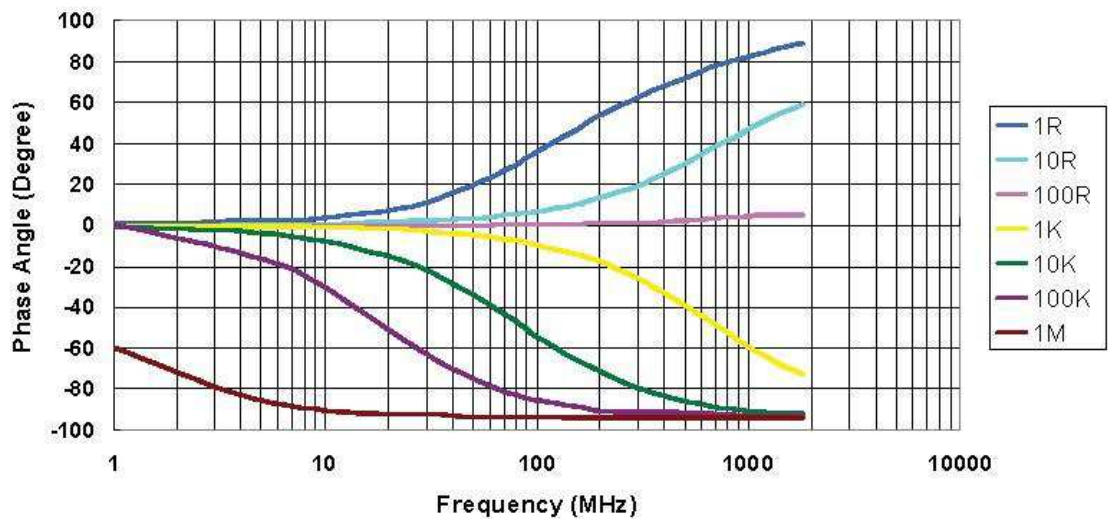

Lightning Surge

Resistors are tested in accordance with IEC 60115-1 using both 1.2/50 μ s and 10/700 μ s pulse shapes. The limit of acceptance is a shift in resistance of less than 0.5% from the initial value.

1.2/50 μ s Lightning Surge

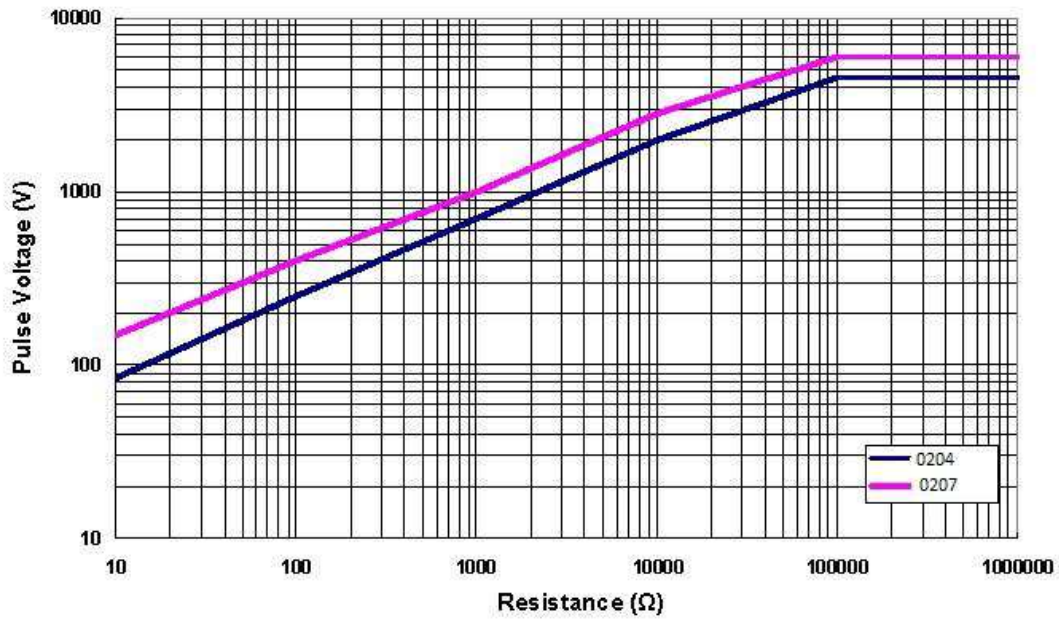

10/700 μ s Lightning Surge

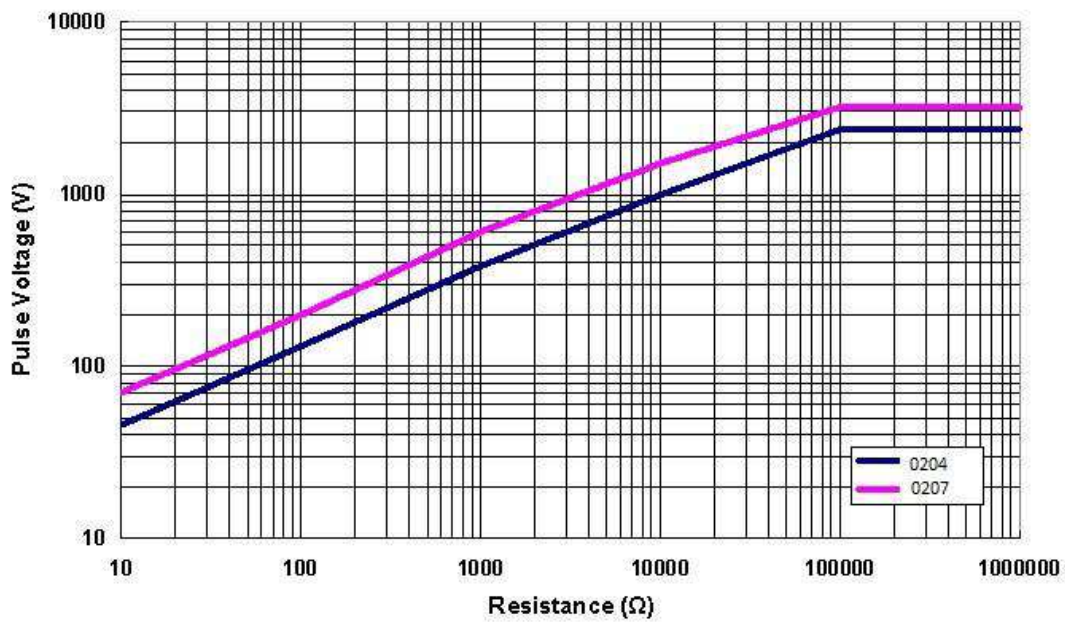

Environmental Characteristics

Item	Requirement	Test Method
Temperature Coefficient of Resistance (T.C.R.)	As Spec	JIS-C-5201-1 4.8 IEC-60115-1 4.8 -55°C~+125°C, 25°C is the reference temperature
Short Time Overload	±(0.15%+0.05Ω)	JIS-C-5201-1 4.13 IEC-60115-1 4.13 RCWV*2.5 or Max. Overload Voltage whichever is lower for 5 seconds
Insulation Resistance	≥10G	JIS-C-5201-1 4.6 IEC-60115-1 4.6 Max. Overload Voltage for 1 minute
Endurance	±(0.5%+0.05Ω)	JIS-C-5201-1 4.25 IEC-60115-1 4.25.1 70±2°C, RCWV for 1000 hrs with 1.5 hrs "ON" and 0.5 hr "OFF"
Damp Heat with Load	±(1.0%+0.05Ω)	JIS-C-5201-1 4.24 IEC-60115-1 4.24 40± 2° C. 90- 95% R.H., RCWV for 1000 hrs with 1.5hrs "ON" and 0.5hr "OFF"
Dry Heat	±(1.0%+0.05Ω)	JIS-C-5201-1 4.23 IEC-60115-1 4.23.2 at +155°C for 1000 hrs
Bending Strength	±(0.5%+0.05Ω)	JIS-C-5201-1 4.33 IEC-60115-1 4.33 Bending once for 5 seconds with 2mm
Solderability	95% min. coverage	JIS-C-5201-1 4.17 IEC-60115-1 4.17 245±5°C for 3 seconds
Resistance to Soldering Heat	±(0.5%+0.05Ω)	JIS-C-5201-1 4.18 IEC-60115-1 4.18 260±5°C for 10 seconds
Voltage Proof	No breakdown or flashover	JIS-C-5201-1 4.7 IEC-60115-1 4.7 1.42 times Max. Operating Voltage for 1 minute
Leaching	Individual leaching area ≤5% Total leaching area ≤ 10%	JIS-C-5201-1 4.18 IEC-60068-2-58 8.2.1 260±5°C for 30 seconds
Rapid Change of Temperature	±(0.5%+0.05Ω)	JIS-C-5201-1 4.19 IEC-60115-1 4.19 -55°C to +125°C, 1000 cycles

RCWV(Rated Continuous Working Voltage)=v(P*R) or Max. Operating Voltage whichever is lower.

Storage Temperature: 15~28°C; Humidity < 80%RH

Packaging

Packaging Quantity and Reel Specification

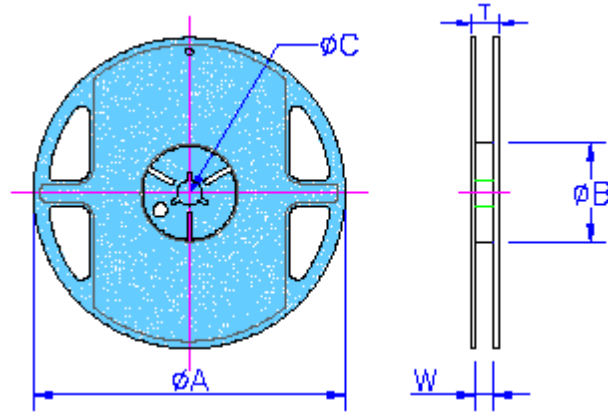

Size	Reel Diameter	ØA (mm)	ØB (mm)	ØC (mm)	W (mm)	T (mm)	Emboss Plastic Tape (EA)
0204	7"	178.5±1.5	60.0±1.0	13.0±0.2	9.0±0.5	12.5±0.5	3,000
0207	7"	178.5±1.5	60.0±1.0	13.0±0.2	13.0±0.5	15.5±0.5	2,000

Embossed Plastic Tape Specification

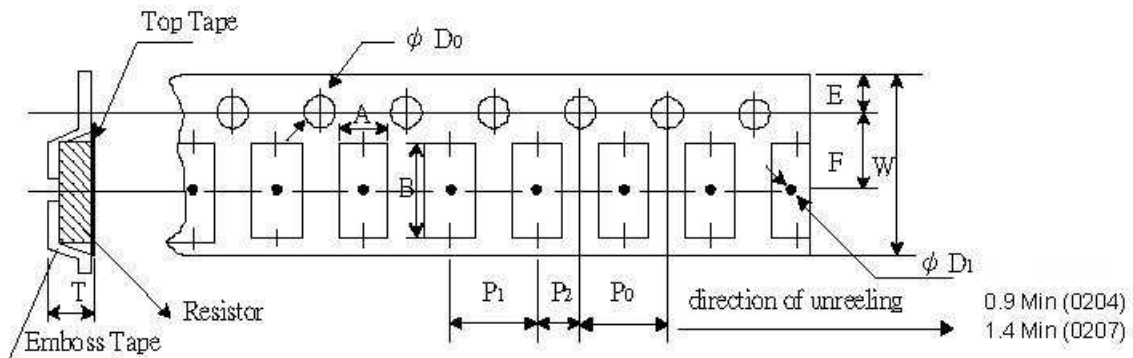

Size	A (mm)	B (mm)	W (mm)	E (mm)	F (mm)	P0 (mm)	P1 (mm)	P2 (mm)	ØD0 (mm)	T (mm)
	±0.10	±0.10	±0.10	±0.10	±0.05	±0.10	±0.10	±0.05	±0.10	±0.10
0204	1.55	3.65	8.0	1.75	3.50	4.00	4.00	2.00	1.50	1.80
0207	2.40	6.15	12.0	1.75	5.50	4.00	4.00	2.00	1.50	2.70

Marking

E-24

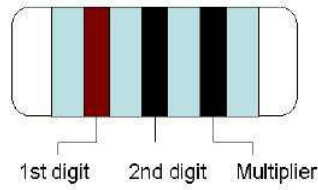

Color	Digit	Multiplier
Silver	-	10^{-2}
Gold	-	10^{-1}
Black	0	10^0
Brown	1	10^1
Red	2	10^2
Orange	3	10^3
Yellow	4	10^4
Green	5	10^5
Blue	6	10^6
Violet	7	10^7
Grey	8	10^8
White	9	10^9

E-96

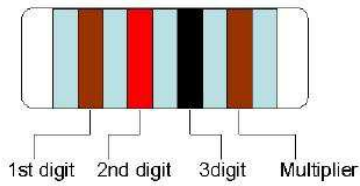

How To Order

SMA	0204	B	T	N	X	100R
Common Part	Size	Tolerance	Packaging	TCR	Power Rating	Resistance Codes
SMA MELF Resistor	0204 0207	B - 0.1% C - 0.25% D - 0.5% F - 1% J - 5%	T - Tape and Reel	B - $\pm 10\text{PPM}/^\circ\text{C}$ N - $\pm 15\text{PPM}/^\circ\text{C}$ C - $\pm 25\text{PPM}/^\circ\text{C}$ D - $\pm 50\text{PPM}/^\circ\text{C}$ E - $\pm 100\text{PPM}/^\circ\text{C}$	T - 1W U - 0.5W X - 0.4W V - 0.25W	R10 - 0.1 Ω 10R - 10 Ω 100R - 100 Ω 1K0 - 1,000 Ω 10K - 10,000 Ω 1M0 - 1,000,000 Ω