

Chip beads
For general signal line
MMZ series



MMZ0402 type



FEATURES

- Noise reduction solution for general signal line.
- Various frequency characteristics with 4 materials of different features for countermeasures against everything from general signals to high-speed signals.
- Operating temperature range: -55 to +125°C

APPLICATION

- Noise removal for mobile devices such as smartphones and tablet terminals, and various modules.
- Noise removal for PCs and recorders, household appliances such as STBs, smart grids, and industrial equipment.

PART NUMBER CONSTRUCTION

MMZ	0402	S	100	C	T	000
Series name	LxWxT dimensions 0.4x0.2x0.2 mm	Material name	Impedance (Ω) at 100MHz	Characteristic type	Packaging style	Internal code

CHARACTERISTICS SPECIFICATION TABLE

Impedance [100MHz] (Ω)	DC resistance (Ω)max.	Rated current (mA)max.	Part No.
10	$\pm 5\Omega$	0.07	MMZ0402S100CT000
70	$\pm 25\%$	0.36	MMZ0402S700CT000
120	$\pm 25\%$	0.70	MMZ0402S121CT000
150	$\pm 25\%$	0.70	MMZ0402S151CT000
240	$\pm 25\%$	1.00	MMZ0402S241CT000
150	$\pm 25\%$	0.62	MMZ0402EUC151CTF0W
180	$\pm 25\%$	0.69	MMZ0402EUC181CTF0W
75	$\pm 25\%$	0.70	MMZ0402Y750CT000
150	$\pm 25\%$	0.69	MMZ0402Y151CT000
22	$\pm 25\%$	0.70	MMZ0402D220CT000

Measurement equipment

Measurement item	Product No.	Manufacturer
Impedance	E4991A+16196D	Keysight Technologies
DC resistance	Type-7556	Yokogawa

* Equivalent measurement equipment may be used.

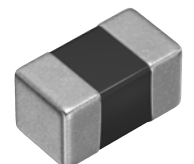

MMZ0402 type

Z VS. FREQUENCY CHARACTERISTICS (BY SERIES)

MMZ0402S series

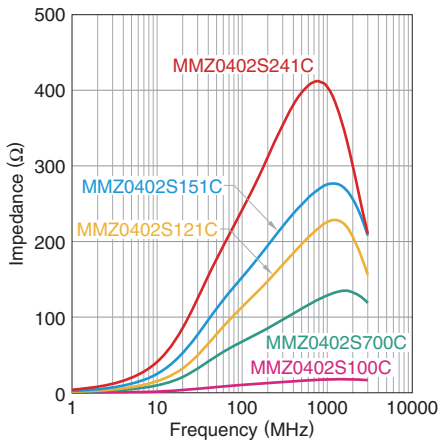

MMZ0402EUC series

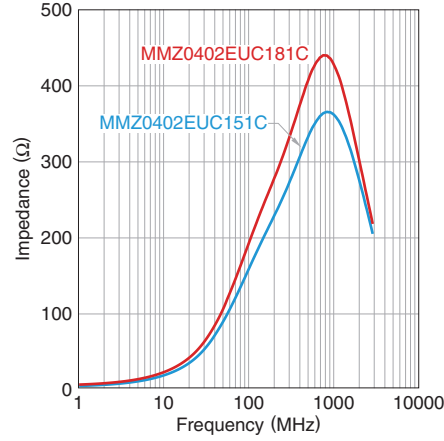

MMZ0402Y series

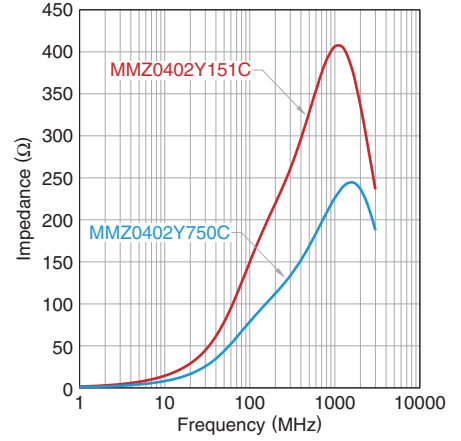

MMZ0402D series

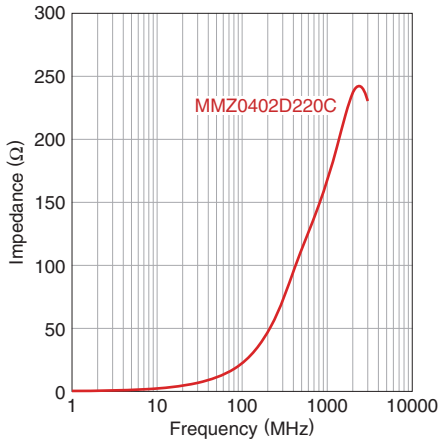

MMZ0402 type

Z, X, R VS. FREQUENCY CHARACTERISTICS

MMZ0402S100CT000

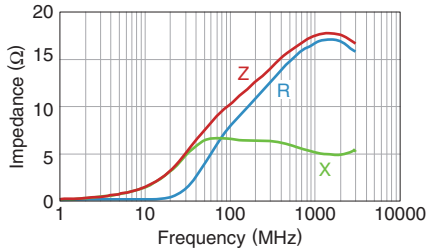

MMZ0402S700CT000

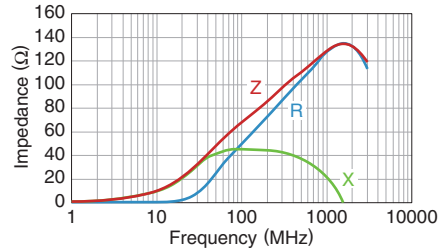

MMZ0402S121CT000

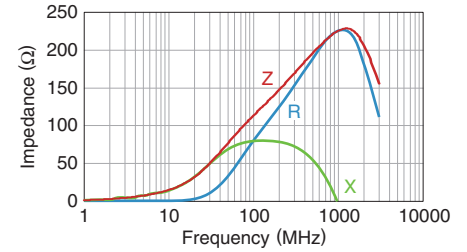

MMZ0402S151CT000

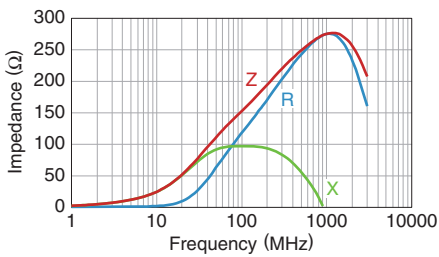

MMZ0402S241CT000

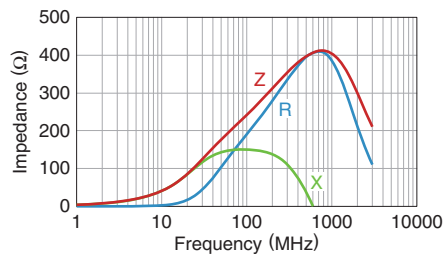

MMZ0402EUC151CTF0W

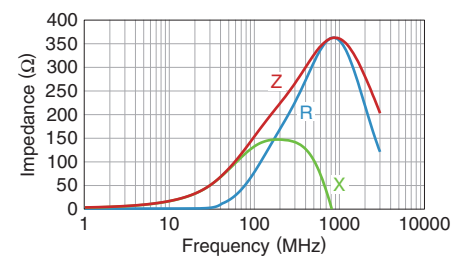

MMZ0402EUC181CTF0W

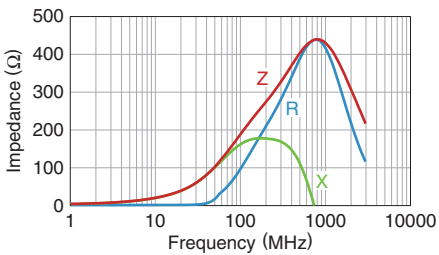

MMZ0402Y750CT000

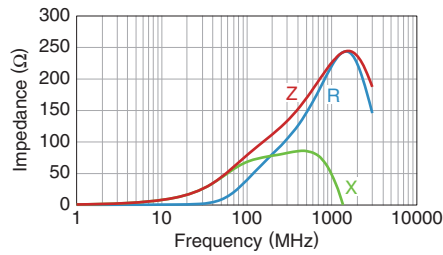

MMZ0402Y151CT000

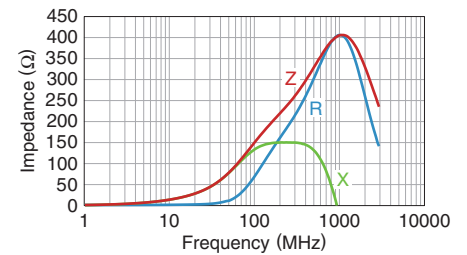

MMZ0402D220CT000

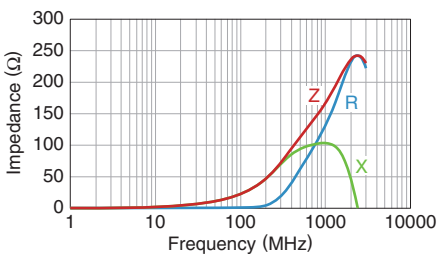

MMZ0402 type

SHAPE & DIMENSIONS

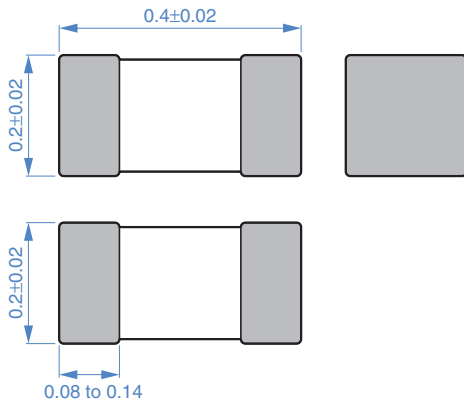

Dimensions in mm

RECOMMENDED LAND PATTERN

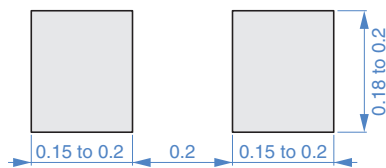

Dimensions in mm

RECOMMENDED REFLOW PROFILE

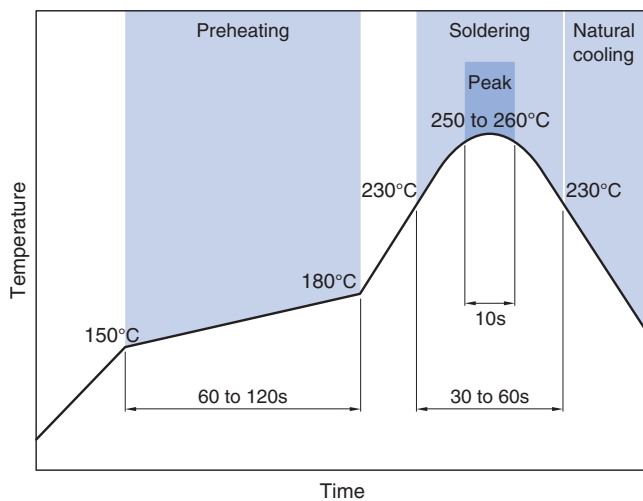

MMZ0402 type

PACKAGING STYLE

REEL DIMENSIONS

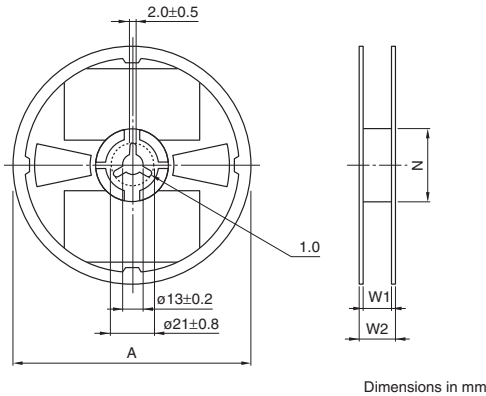

Type	Package specifications	A	W1	W2	N
MMZ0402**T000	Paper carrier (W8P2)	ø180±2.0	8.4+2.0, -0.0	14.4max.	ø60min.
MMZ0402**TF0W	Plastic carrier (W4P1)	ø178±2.0	5.0±1.0	—	ø60±2.0

TAPE DIMENSIONS

Paper carrier (W8P2)

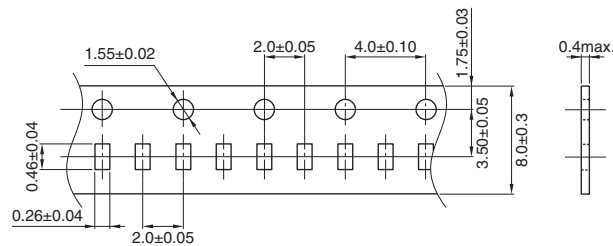

Plastic carrier (W4P1)

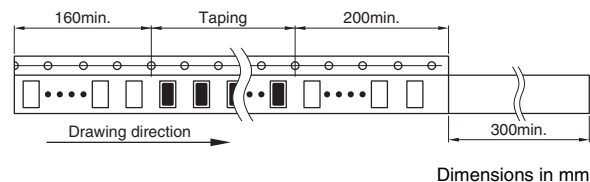
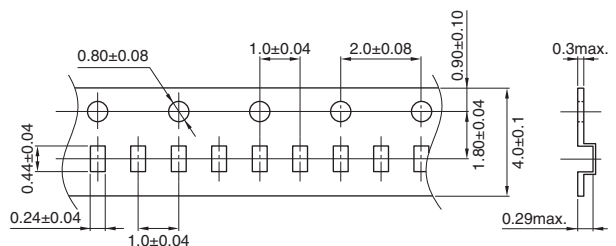

PACKAGE QUANTITY

Package quantity	MMZ0402**T000 (W8P2 Paper carrier)	20,000 pcs/reel
	MMZ0402**TF0W (W4P1 Plastic carrier)	40,000 pcs/reel

TEMPERATURE RANGE, INDIVIDUAL WEIGHT

Type	Operating temperature range	Storage temperature range*	Individual weight
MMZ0402**T000 (W8P2 Paper carrier)	-55 to +125 °C	-55 to +125 °C	0.08 mg
MMZ0402**TF0W (W4P1 Plastic carrier)	-55 to +125 °C	-55 to +125 °C	0.08 mg

* The storage temperature range is for after the assembly.

REMINDERS FOR USING THESE PRODUCTS

Before using these products, be sure to request the delivery specifications.

SAFETY REMINDERS

Please pay sufficient attention to the warnings for safe designing when using this products.

REMINDERS

- The storage period is within 12 months. Be sure to follow the storage conditions (temperature: 5 to 40°C, humidity: 10 to 75% RH or less).
If the storage period elapses, the soldering of the terminal electrodes may deteriorate.
- Do not use or store in locations where there are conditions such as gas corrosion (salt, acid, alkali, etc.).
- Before soldering, be sure to preheat components.
The preheating temperature should be set so that the temperature difference between the solder temperature and chip temperature does not exceed 150°C.
- Soldering corrections after mounting should be within the range of the conditions determined in the specifications.
If overheated, a short circuit, performance deterioration, or lifespan shortening may occur.
- When embedding a printed circuit board where a chip is mounted to a set, be sure that residual stress is not given to the chip due to the overall distortion of the printed circuit board and partial distortion such as at screw tightening portions.
- Self heating (temperature increase) occurs when the power is turned ON, so the tolerance should be sufficient for the set thermal design.
- Carefully lay out the coil for the circuit board design of the non-magnetic shield type.
A malfunction may occur due to magnetic interference.
- Use a wrist band to discharge static electricity in your body through the grounding wire.
- Do not expose the products to magnets or magnetic fields.
- Do not use for a purpose outside of the contents regulated in the delivery specifications.
- The products listed on this catalog are intended for use in general electronic equipment (AV equipment, telecommunications equipment, home appliances, amusement equipment, computer equipment, personal equipment, office equipment, measurement equipment, industrial robots) under a normal operation and use condition.
The products are not designed or warranted to meet the requirements of the applications listed below, whose performance and/or quality require a more stringent level of safety or reliability, or whose failure, malfunction or trouble could cause serious damage to society, person or property.
If you intend to use the products in the applications listed below or if you have special requirements exceeding the range or conditions set forth in the each catalog, please contact us.

- (1) Aerospace/aviation equipment
- (2) Transportation equipment (cars, electric trains, ships, etc.)
- (3) Medical equipment
- (4) Power-generation control equipment
- (5) Atomic energy-related equipment
- (6) Seabed equipment
- (7) Transportation control equipment

- (8) Public information-processing equipment
- (9) Military equipment
- (10) Electric heating apparatus, burning equipment
- (11) Disaster prevention/crime prevention equipment
- (12) Safety equipment
- (13) Other applications that are not considered general-purpose applications

When designing your equipment even for general-purpose applications, you are kindly requested to take into consideration securing protection circuit/device or providing backup circuits in your equipment.