

## NFC circuit/inductors for standard circuits

## Multilayer ferrite

## MLJ series



## MLJ1005 type



## FEATURES

- Response to large currents with newly-developed ferrite materials.
- Narrow tolerance response with high-accuracy multiple layers.
- Significant reductions of high-frequency loss due to the adoption of low-loss materials.
- Operating temperature range: -55 to +125°C

## APPLICATION

- NFC circuits for devices such as smartphones and PCs, and power lines for electronic devices.
- Application guides: [Smart phones/tablets](#)

## PART NUMBER CONSTRUCTION

MLJ	1005	W	R16	△	T	000
Series name	LxWxH dimensions 1.0x0.5x0.5 mm	Characteristics	Inductance (nH)	Inductance tolerance	Packaging style	Internal code

\* The "△" of the Part Number contains the inductance tolerance code, J (±5%), K (±10%), or M (±20%).

## CHARACTERISTICS SPECIFICATION TABLE

L (nH)	Q Tolerance	L, Q measuring conditions		Self-resonant frequency (MHz)min. (MHz)typ.	DC resistance (Ω)max.	Rated current			Part No.		
		Frequency (MHz)	Current (mA)			I <sub>sat</sub> (mA)max.	I <sub>sat</sub> (mA)typ.	I <sub>temp</sub> (mA)max.			
75	±5% ±10%	15	25	1.0	650	950	0.25	400	500	550	<a href="#">MLJ1005W75NJT000</a> <a href="#">MLJ1005W75NKT000</a>
100	±5% ±10%	15	25	1.0	550	830	0.30	400	500	500	<a href="#">MLJ1005WR10JT000</a> <a href="#">MLJ1005WR10KT000</a>
120	±5% ±10%	15	25	1.0	460	740	0.39	380	450	450	<a href="#">MLJ1005WR12JT000</a> <a href="#">MLJ1005WR12KT000</a>
140	±5% ±10%	15	25	1.0	400	650	0.45	380	450	450	<a href="#">MLJ1005WR14JT000</a> <a href="#">MLJ1005WR14KT000</a>
150	±5% ±10%	15	25	1.0	400	600	0.45	350	450	450	<a href="#">MLJ1005WR15JT000</a> <a href="#">MLJ1005WR15KT000</a>
160	±5% ±10%	15	25	1.0	330	600	0.52	350	450	400	<a href="#">MLJ1005WR16JT000</a> <a href="#">MLJ1005WR16KT000</a>
180	±5% ±10%	15	25	1.0	320	570	0.58	300	370	400	<a href="#">MLJ1005WR18JT000</a> <a href="#">MLJ1005WR18KT000</a>
220	±5% ±10%	15	25	1.0	290	500	0.58	300	370	400	<a href="#">MLJ1005WR22JT000</a> <a href="#">MLJ1005WR22KT000</a>
270	±5% ±10%	15	25	1.0	260	450	0.65	280	350	350	<a href="#">MLJ1005WR27JT000</a> <a href="#">MLJ1005WR27KT000</a>
330	±5% ±10%	15	25	1.0	230	380	0.65	230	300	350	<a href="#">MLJ1005WR33JT000</a> <a href="#">MLJ1005WR33KT000</a>

## Measurement equipment

Measurement item	Product No.	Manufacturer
L, Q	4294A+16034G	Keysight Technologies
Self-resonant frequency	E4991A	Keysight Technologies
DC resistance	Type-7561	Yokogawa

\* Equivalent measurement equipment may be used.

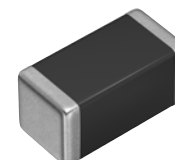

⚠ Please be sure to request delivery specifications that provide further details on the features and specifications of the products for proper and safe use.  
Please note that the contents may change without any prior notice due to reasons such as upgrading.

(1/5)

20190111

inductor\_commercial\_standard\_mlj1005\_en

# MLJ1005 type

## CHARACTERISTICS SPECIFICATION TABLE

L (nH)	Tolerance	Q min.	L, Q measuring conditions		Self-resonant frequency		DC resistance ( $\Omega$ )max.	Rated current		Part No.	
			Frequency (MHz)	Current (mA)	(MHz)min.	(MHz)typ.		Isat (mA)typ.	Isat (mA)max.		Itemp (mA)max.
390	$\pm 5\%$ $\pm 10\%$	15	25	1.0	210	330	0.97	230	300	300	<a href="#">MLJ1005WR39JT000</a> <a href="#">MLJ1005WR39KT000</a>
470	$\pm 5\%$ $\pm 10\%$	15	25	1.0	190	300	0.97	200	250	300	<a href="#">MLJ1005WR47JT000</a> <a href="#">MLJ1005WR47KT000</a>
560	$\pm 5\%$ $\pm 10\%$	15	25	1.0	170	250	1.40	200	250	250	<a href="#">MLJ1005WR56JT000</a> <a href="#">MLJ1005WR56KT000</a>

### Measurement equipment

Measurement item	Product No.	Manufacturer
L, Q	4294A+16034G	Keysight Technologies
Self-resonant frequency	E4991A	Keysight Technologies
DC resistance	Type-7561	Yokogawa

\* Equivalent measurement equipment may be used.

# MLJ1005 type

## L FREQUENCY CHARACTERISTICS

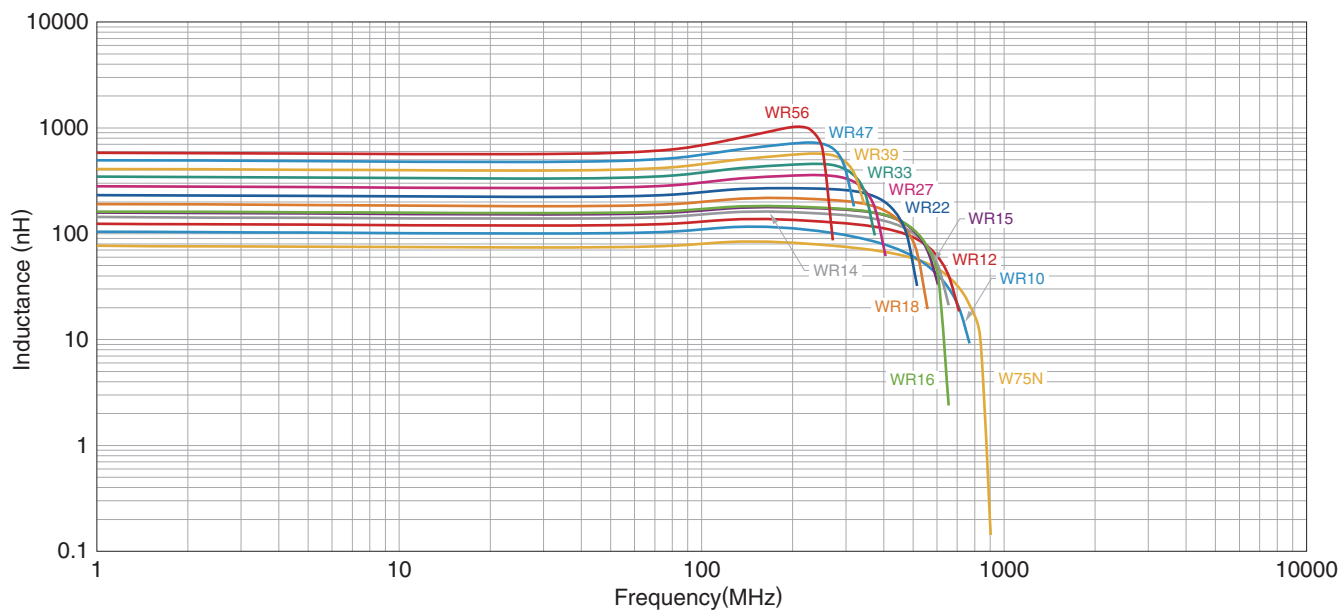

Measurement equipment

Product No.	Manufacturer
4294A+16034G	Keysight Technologies

\* Equivalent measurement equipment may be used.

## Q FREQUENCY CHARACTERISTICS

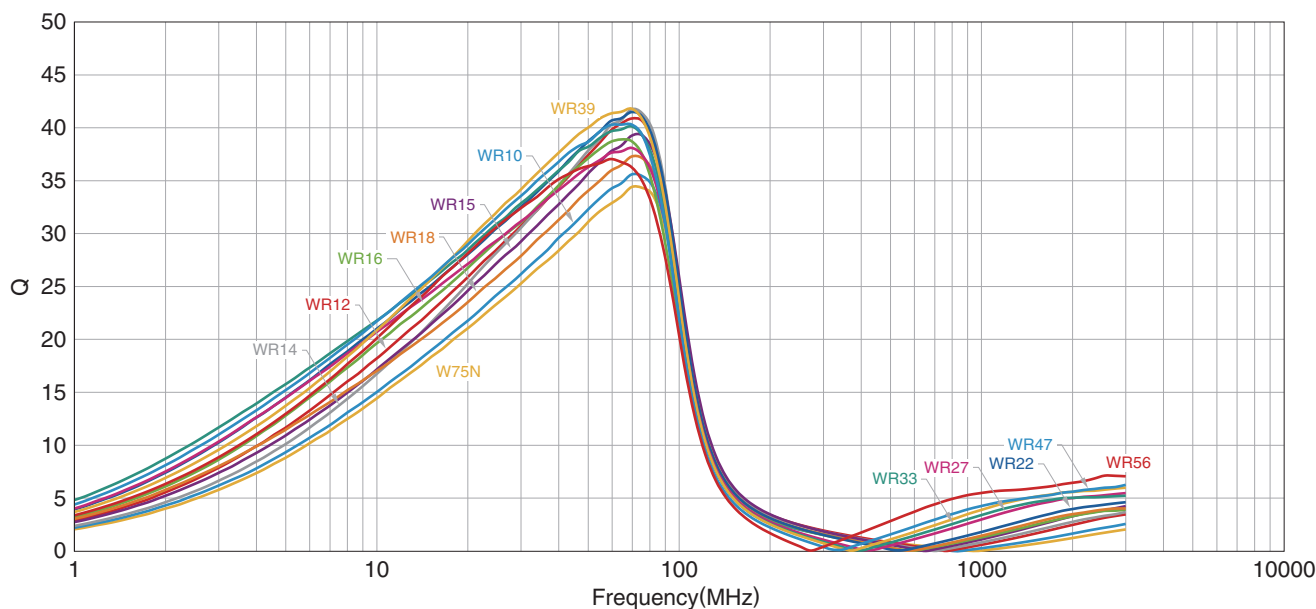

Measurement equipment

Product No.	Manufacturer
4294A+16034G	Keysight Technologies

\* Equivalent measurement equipment may be used.

# MLJ1005 type

## SHAPE & DIMENSIONS

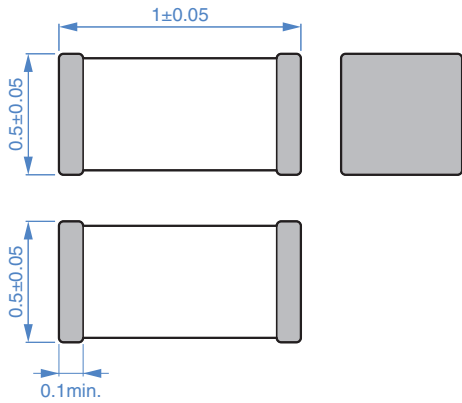

Dimensions in mm

## RECOMMENDED LAND PATTERN

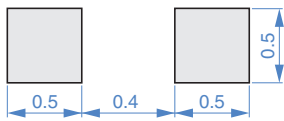

Dimensions in mm

## RECOMMENDED REFLOW PROFILE

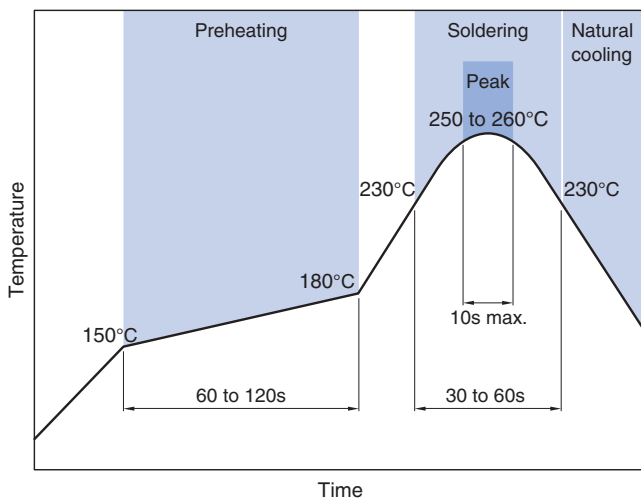

## PACKAGING STYLE

### REEL DIMENSIONS

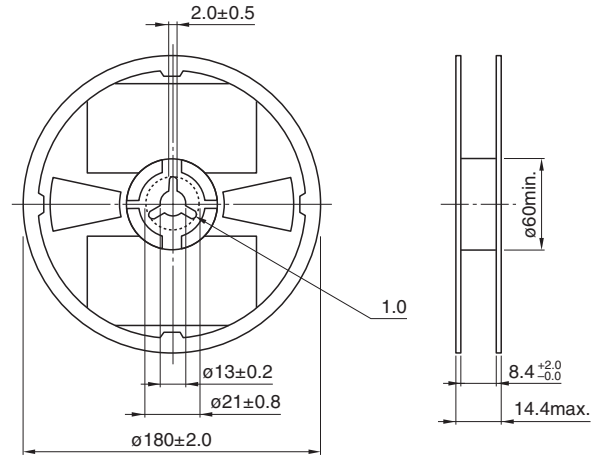

Dimensions in mm

### TAPE DIMENSIONS

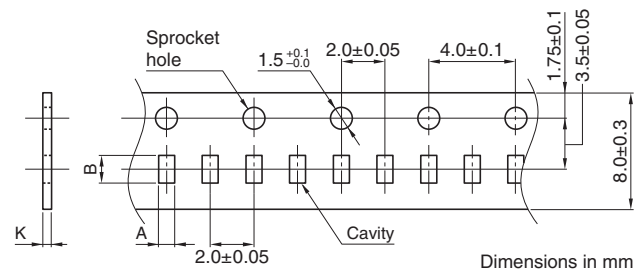

Dimensions in mm

Type	A	B	K
MLJ1005	0.65±0.1	1.15±0.1	0.8 max.

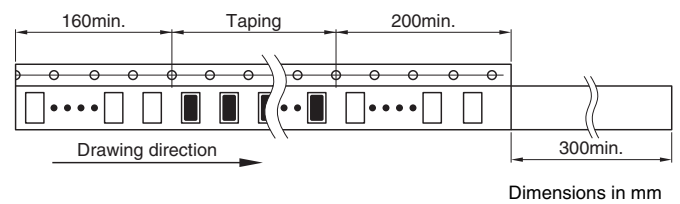

Dimensions in mm

### PACKAGE QUANTITY

Package quantity	10000 pcs/reel
------------------	----------------

### TEMPERATURE RANGE, INDIVIDUAL WEIGHT

Operating temperature range	Storage temperature range*	Individual weight
-55 to +125 °C	-55 to +125 °C	1.2 mg

\* The storage temperature range is for after the assembly.

## REMINDERS FOR USING THESE PRODUCTS

Before using these products, be sure to request the delivery specifications.

### SAFETY REMINDERS

Please pay sufficient attention to the warnings for safe designing when using this products.

#### REMINDERS

- The storage period is less than 12 months. Be sure to follow the storage conditions (temperature: 5 to 40°C, humidity: 10 to 75% RH or less).  
If the storage period elapses, the soldering of the terminal electrodes may deteriorate.
- Do not use or store in locations where there are conditions such as gas corrosion (salt, acid, alkali, etc.).
- Before soldering, be sure to preheat components.  
The preheating temperature should be set so that the temperature difference between the solder temperature and chip temperature does not exceed 150°C.
- Soldering corrections after mounting should be within the range of the conditions determined in the specifications.  
If overheated, a short circuit, performance deterioration, or lifespan shortening may occur.
- When embedding a printed circuit board where a chip is mounted to a set, be sure that residual stress is not given to the chip due to the overall distortion of the printed circuit board and partial distortion such as at screw tightening portions.
- Self heating (temperature increase) occurs when the power is turned ON, so the tolerance should be sufficient for the set thermal design.
- Carefully lay out the coil for the circuit board design of the non-magnetic shield type.  
A malfunction may occur due to magnetic interference.
- Use a wrist band to discharge static electricity in your body through the grounding wire.
- Do not expose the products to magnets or magnetic fields.
- Do not use for a purpose outside of the contents regulated in the delivery specifications.
- The products listed on this catalog are intended for use in general electronic equipment (AV equipment, telecommunications equipment, home appliances, amusement equipment, computer equipment, personal equipment, office equipment, measurement equipment, industrial robots) under a normal operation and use condition.  
The products are not designed or warranted to meet the requirements of the applications listed below, whose performance and/or quality require a more stringent level of safety or reliability, or whose failure, malfunction or trouble could cause serious damage to society, person or property.  
If you intend to use the products in the applications listed below or if you have special requirements exceeding the range or conditions set forth in the each catalog, please contact us.

- (1) Aerospace/aviation equipment
- (2) Transportation equipment (cars, electric trains, ships, etc.)
- (3) Medical equipment
- (4) Power-generation control equipment
- (5) Atomic energy-related equipment
- (6) Seabed equipment
- (7) Transportation control equipment

- (8) Public information-processing equipment
- (9) Military equipment
- (10) Electric heating apparatus, burning equipment
- (11) Disaster prevention/crime prevention equipment
- (12) Safety equipment
- (13) Other applications that are not considered general-purpose applications

When designing your equipment even for general-purpose applications, you are kindly requested to take into consideration securing protection circuit/device or providing backup circuits in your equipment.