



Chip beads

For general signal line

Soft termination

KMZ-HR series (for automotive)

KMZ1608-HR_{type}

KMZ1608-HR **1608[0603 inch]***

* Dimensions code JIS[EIA]

REMINDERS FOR USING THESE PRODUCTS

Before using these products, be sure to request the delivery specifications.

SAFETY REMINDERS

Please pay sufficient attention to the warnings for safe designing when using these products.

REMINDERS

- The storage period is less than 12 months. Be sure to follow the storage conditions (Temperature: 5 to 40°C, Humidity: 10 to 75% RH or less).
If the storage period elapses, the soldering of the terminal electrodes may deteriorate.
- Do not use or store in locations where there are conditions such as gas corrosion (salt, acid, alkali, etc.).
- Before soldering, be sure to preheat components.
The preheating temperature should be set so that the temperature difference between the solder temperature and chip temperature does not exceed 150°C.
- Soldering corrections after mounting should be within the range of the conditions determined in the specifications.
If overheated, a short circuit, performance deterioration, or lifespan shortening may occur.
- When embedding a printed circuit board where a chip is mounted to a set, be sure that residual stress is not given to the chip due to the overall distortion of the printed circuit board and partial distortion such as at screw tightening portions.
- Self heating (temperature increase) occurs when the power is turned ON, so the tolerance should be sufficient for the set thermal design.
- Carefully lay out the coil for the circuit board design of the non-magnetic shield type.
A malfunction may occur due to magnetic interference.
- Use a wrist band to discharge static electricity in your body through the grounding wire.
- Do not expose the products to magnets or magnetic fields.
- Do not use for a purpose outside of the contents regulated in the delivery specifications.
- The products listed on this catalog are intended for use in general electronic equipment (AV equipment, telecommunications equipment, home appliances, amusement equipment, computer equipment, personal equipment, office equipment, measurement equipment, industrial robots) under a normal operation and use condition.
The products are not designed or warranted to meet the requirements of the applications listed below, whose performance and/or quality require a more stringent level of safety or reliability, or whose failure, malfunction or trouble could cause serious damage to society, person or property.
If you intend to use the products in the applications listed below or if you have special requirements exceeding the range or conditions set forth in the each catalog, please contact us.

- (1) Aerospace/Aviation equipment
- (2) Transportation equipment (electric trains, ships, etc.)
- (3) Medical equipment
- (4) Power-generation control equipment
- (5) Atomic energy-related equipment
- (6) Seabed equipment
- (7) Transportation control equipment

- (8) Public information-processing equipment
- (9) Military equipment
- (10) Electric heating apparatus, burning equipment
- (11) Disaster prevention/crime prevention equipment
- (12) Safety equipment
- (13) Other applications that are not considered general-purpose applications

When designing your equipment even for general-purpose applications, you are kindly requested to take into consideration securing protection circuit/device or providing backup circuits in your equipment.

Chip beads

For general signal line

Soft termination

Product compatible with RoHS directive
Halogen-free
Compatible with lead-free solders
AEC-Q200

Overview of KMZ1608-HR type

FEATURES

- Noise reduction solution for general signal line.
- Various frequency characteristics with 6 materials of different features for countermeasures against everything from general signals to high-speed signals.
- Guide electric property resin absorbs external stress, and mechanical stress, resistance force to thermal shock is improved.
- Easing by conductive resin thermal stress, and respond for High-temperature environment of 150 °C, too.

APPLICATION

Various ECUs, powertrains, body controls, and car multimedia (telematics).

PART NUMBER CONSTRUCTION

Series name	LxWxT dimensions (mm)	Material name	Specifications (Grade)	Impedance (Ω) at 100MHz	Characteristic type	Packaging style	Internal code
KMZ1608-HR	1.6x0.8x0.6	A	HR Soft termination	601	600	T Taping	DH5
		B		102	1000		D25
	1.6x0.8x0.8	D					
		R					
		S					
		Y					

OPERATING TEMPERATURE RANGE, PACKAGE QUANTITY, PRODUCT WEIGHT

Type	Temperature range		Package quantity (pieces/reel)	Individual weight (mg)
	Operating temperature (°C)	Storage temperature* (°C)		
KMZ1608-HR	t=0.6mm (DH5)	-55 to +150	4,000	3
	t=0.8mm (D25)	-55 to +150	4,000	4

* The storage temperature range is for after the circuit board is mounted.

- RoHS Directive Compliant Product: See the following for more details. <https://product.tdk.com/info/en/environment/rohs/index.html>
- Halogen-free: Indicates that Cl content is less than 900ppm, Br content is less than 900ppm, and that the total Cl and Br content is less than 1500ppm.

 Please be sure to request delivery specifications that provide further details on the features and specifications of the products for proper and safe use. Please note that the contents may change without any prior notice due to reasons such as upgrading.

KMZ1608-HR type

RECOMMENDED REFLOW PROFILE



Preheating			Soldering		Peak	
Temp.	Time		Temp.	Time	Temp.	Time
T1	T2	t1	T3	t2	T4	t3
150°C	180°C	60 to 120s	230°C	30 to 60s	250 to 260°C	10s

KMZ1608-HR type

MATERIAL CHARACTERISTIC

B material: This type is perfectly suited for fast digital signals. By equalizing R components and X components that beads possess at a frequency of 5MHz, it is able to suppress overshooting, undershooting and ringing of fast digital signals.

R material: For wide frequency applications calling for broad impedance characteristics. For digital signal line applications calling requiring good waveform integrity. Impedance values selected for effectiveness at 10 to 200MHz.

S material: Standard type that features impedance characteristics similar to those of a typical ferrite core. For signal line applications in which the blocking region is near 100MHz. Impedance values selected for effectiveness at 40 to 300MHz.

Y material: High frequency range type intended for the 100MHz region and above. For signal line applications in which the signal frequency is far from the cutoff frequency. Impedance values selected for effectiveness at 80 to 400MHz.

A material: This high-impedance product is based on the impedance frequency characteristics of our Y-material. The product offers excellent impedance characteristics, which is greater than 2500Ω , in the vicinity of 100MHz range (KMZ1608AHR252B).

D material: For applications calling for low insertion loss at low frequencies and sharply increasing impedance at high frequencies. Designed for high impedance at high frequencies (300MHz to 1GHz) for signal line applications.

TYPICAL MATERIAL IMPEDANCE CHARACTERISTICS

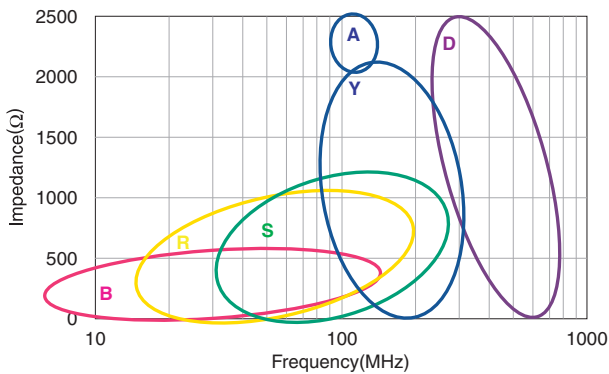

KMZ1608-HR type

SHAPE & DIMENSIONS

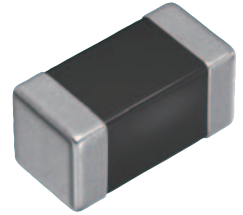
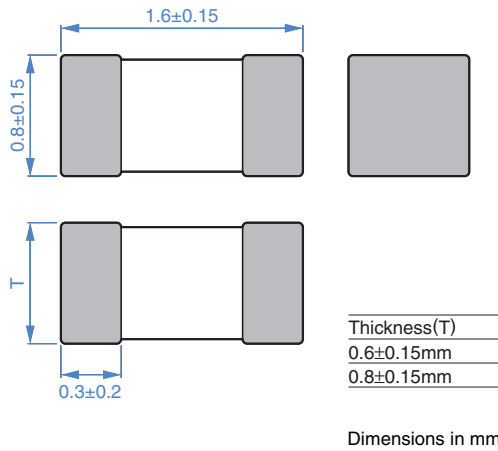

RECOMMENDED LAND PATTERN

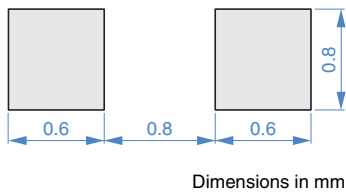

KMZ1608-HR type

ELECTRICAL CHARACTERISTICS

CHARACTERISTICS SPECIFICATION TABLE

Impedance [100MHz] (Ω)		DC resistance (Ω)max.	Rated current* (mA)max.	Thickness T (mm)	Part No.
	Tolerance				
600	±25%	0.4	500	0.6	KMZ1608BHR601CTDH5
1000	±25%	0.6	300	0.8	KMZ1608BHR102CTD25
60	±25%	0.1	800	0.8	KMZ1608RHR600ATD25
120	±25%	0.18	500	0.8	KMZ1608RHR121ATD25
600	±25%	0.4	500	0.8	KMZ1608RHR601ATD25
1000	±25%	0.5	400	0.8	KMZ1608RHR102ATD25
120	±25%	0.15	500	0.8	KMZ1608SHR121ATD25
600	±25%	0.35	500	0.8	KMZ1608SHR601ATD25
1000	±25%	0.5	400	0.8	KMZ1608SHR102ATD25
60	±25%	0.15	500	0.8	KMZ1608YHR600BTD25
120	±25%	0.2	500	0.8	KMZ1608YHR121BTD25
300	±25%	0.3	500	0.8	KMZ1608YHR301BTD25
600	±25%	0.4	500	0.8	KMZ1608YHR601BTD25
1000	±25%	0.5	400	0.8	KMZ1608YHR102BTD25
1500	±25%	0.6	300	0.8	KMZ1608YHR152BTD25
2500	±25%	0.8	200	0.8	KMZ1608AHR252BTD25
50	±25%	0.25	500	0.6	KMZ1608DHR500CTDH5
120	±25%	0.3	400	0.6	KMZ1608DHR121CTDH5
240	±25%	0.6	300	0.8	KMZ1608DHR241CTD25

* Please refer to the graph of rated current vs. temperature characteristics (derating) about the rating current at 125°C or more in temperature of the product.

Measurement equipment

Measurement item	Product No.	Manufacturer
Impedance	E4991A+16192A	Keysight Technologies
DC resistance	Type-7556	Yokogawa

* Equivalent measurement equipment may be used.

Rated current vs. temperature characteristics (derating)

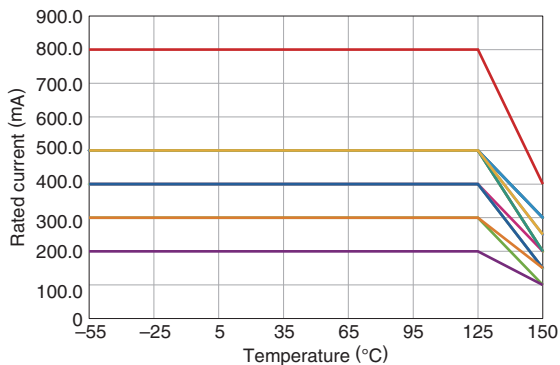

— RHR600A	— RHR121A, SHR121A, YHR600B, YHR121B,
— YHR301B, DHR500C	— BHR601C, RHR601A, SHR601A, YHR601B
— SHR102A	— RHR102A, YHR102B, DHR121C
— BHR102C, DHR241C	— YHR152B
	— AHR252B

⚠ Please be sure to request delivery specifications that provide further details on the features and specifications of the products for proper and safe use.
Please note that the contents may change without any prior notice due to reasons such as upgrading.

KMZ1608-HR type

ELECTRICAL CHARACTERISTICS

Z VS. FREQUENCY CHARACTERISTICS (BY SERIES)

KMZ1608BHR series

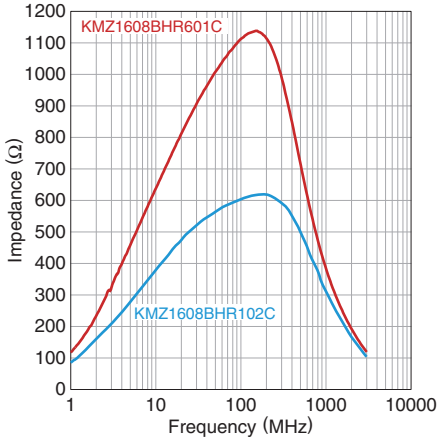

KMZ1608RHR series

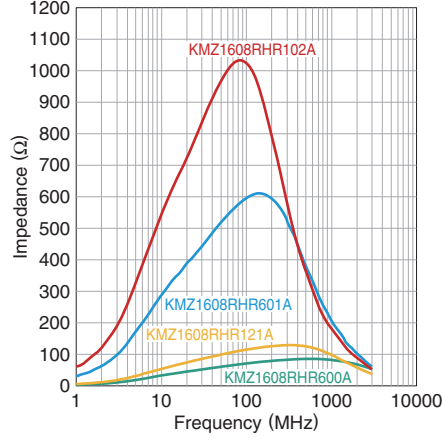

KMZ1608SHR series

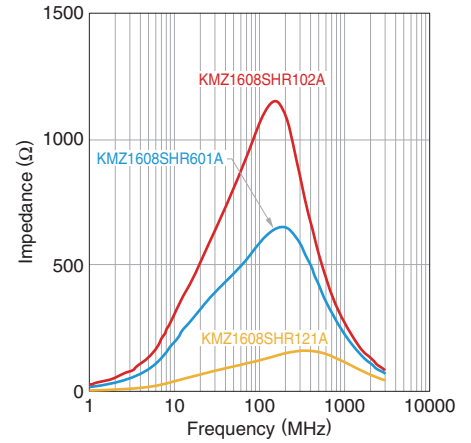

KMZ1608YHR series

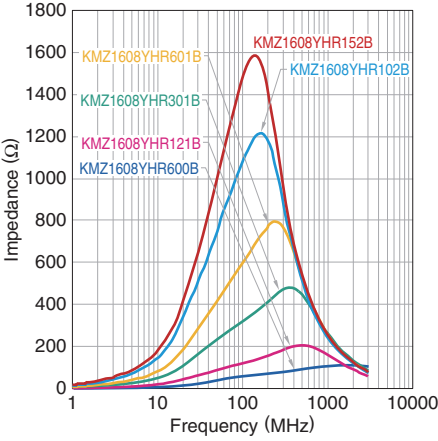

KMZ1608AHR series

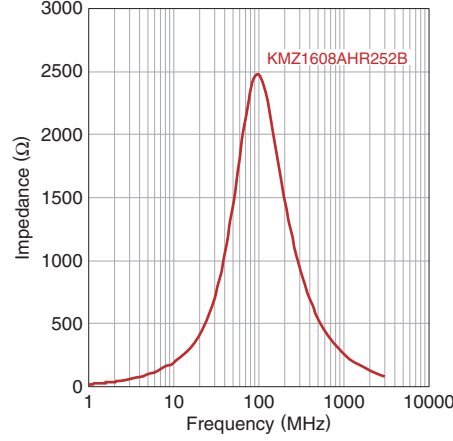

KMZ1608DHR series

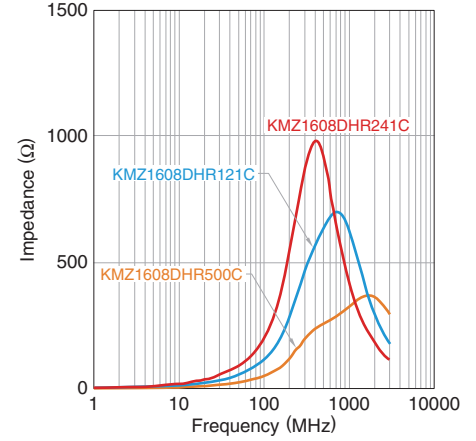

 Please be sure to request delivery specifications that provide further details on the features and specifications of the products for proper and safe use. Please note that the contents may change without any prior notice due to reasons such as upgrading.

KMZ1608-HR type

ELECTRICAL CHARACTERISTICS

Z, X, R VS. FREQUENCY CHARACTERISTICS

KMZ1608BHR601CTDH5

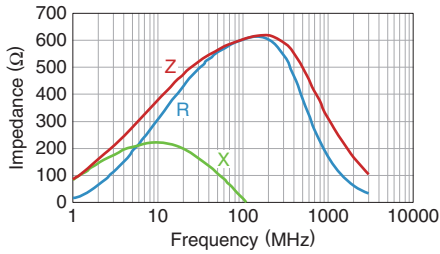

KMZ1608BHR102CTD25

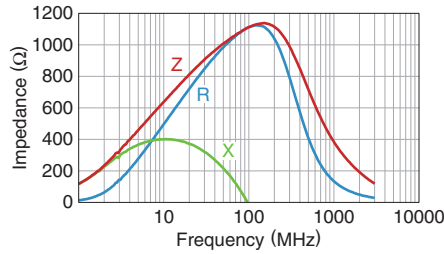

KMZ1608RHR600ATD25

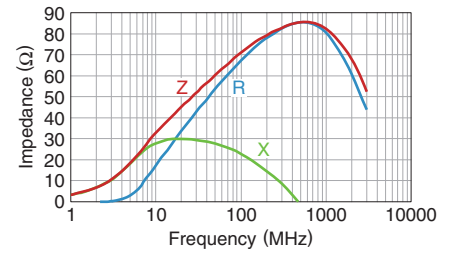

KMZ1608RHR121ATD25

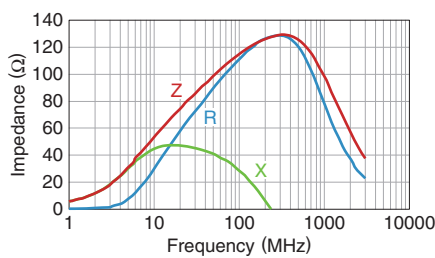

KMZ1608RHR601ATD25

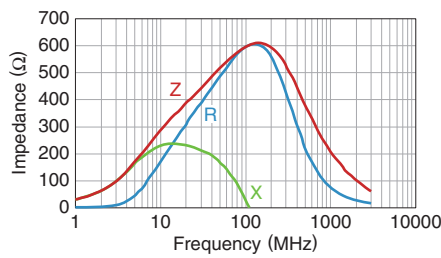

KMZ1608RHR102ATD25

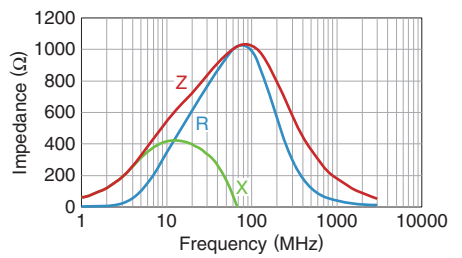

KMZ1608SHR121ATD25

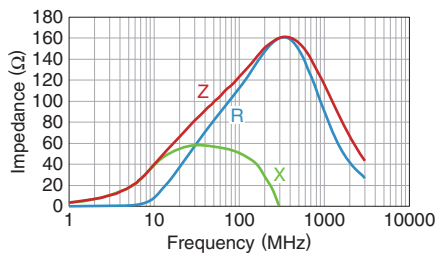

KMZ1608SHR601ATD25

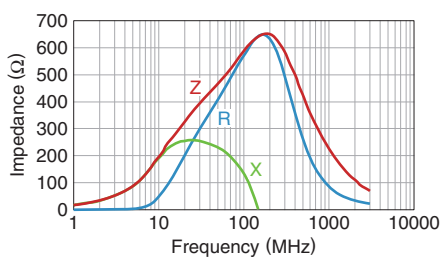

KMZ1608SHR102ATD25

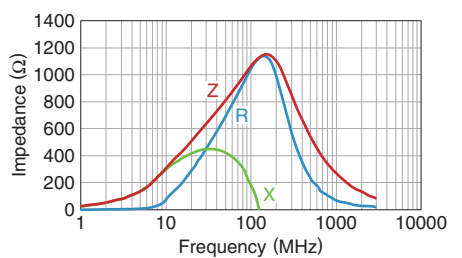

KMZ1608YHR600BTD25

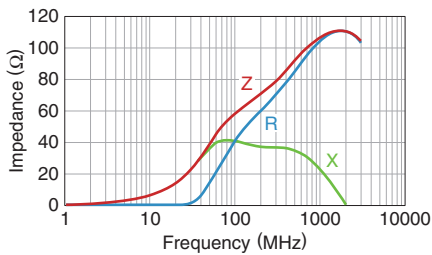

KMZ1608YHR121BTD25

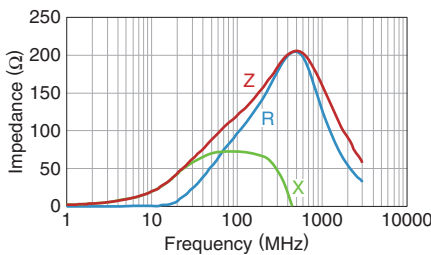

KMZ1608YHR301BTD25

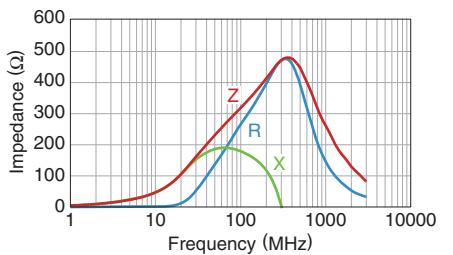

KMZ1608YHR601BTD25

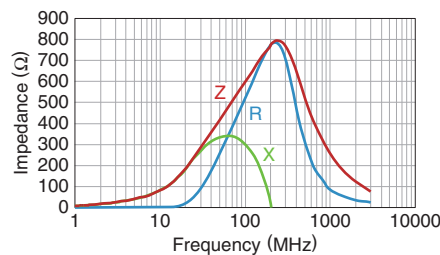

KMZ1608YHR102BTD25

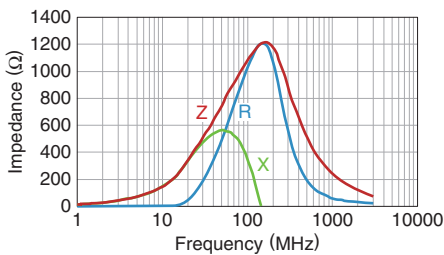

KMZ1608YHR152BTD25

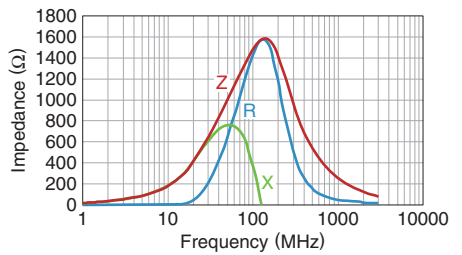

 Please be sure to request delivery specifications that provide further details on the features and specifications of the products for proper and safe use. Please note that the contents may change without any prior notice due to reasons such as upgrading.

KMZ1608-HR type

ELECTRICAL CHARACTERISTICS

Z, X, R VS. FREQUENCY CHARACTERISTICS

KMZ1608AHR252BTD25

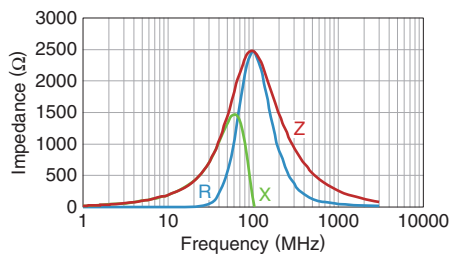

KMZ1608DHR500CTDH5

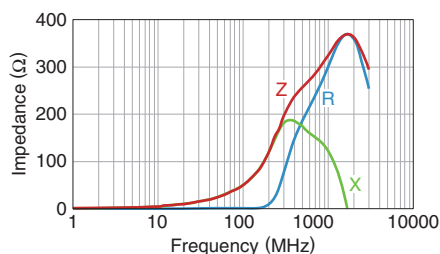

KMZ1608DHR121CTDH5

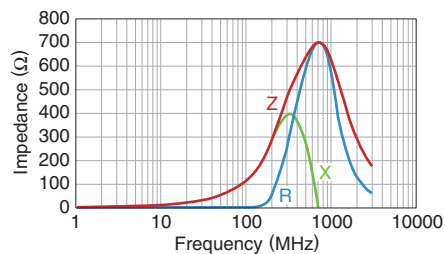

KMZ1608DHR241CTD25

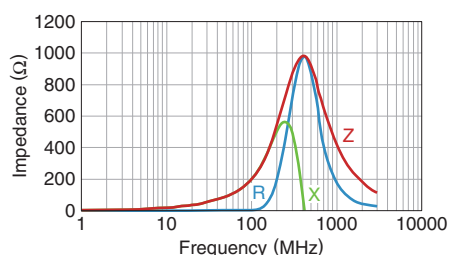

Please be sure to request delivery specifications that provide further details on the features and specifications of the products for proper and safe use. Please note that the contents may change without any prior notice due to reasons such as upgrading.

KMZ1608-HR type

PACKAGING STYLE

REEL DIMENSIONS

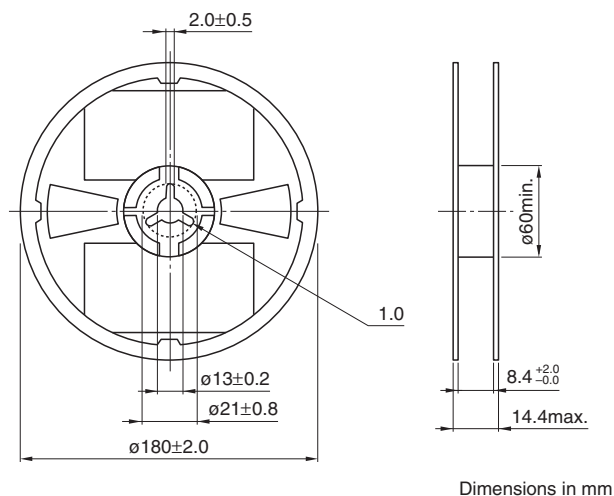

TAPE DIMENSIONS

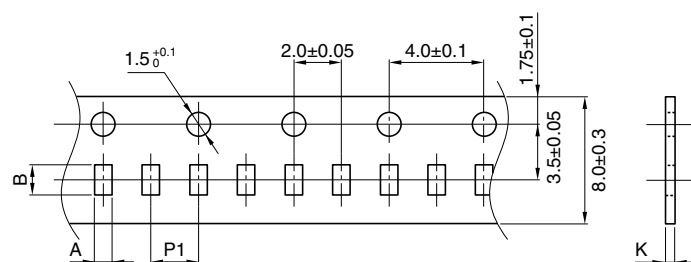

Type	A	B	P1	K
KMZ1608-HR	1.1 ± 0.2	1.9 ± 0.2	4.0 ± 0.1	1.1max.

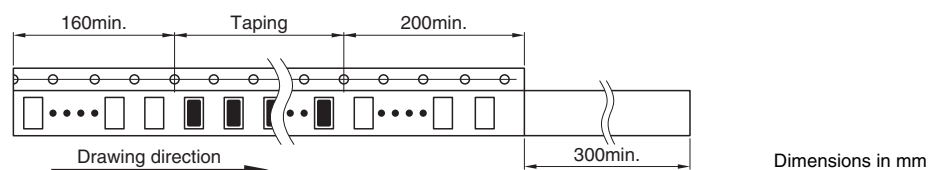

Mouser Electronics

Authorized Distributor

Click to View Pricing, Inventory, Delivery & Lifecycle Information:

TDK:

[KMZ1608RHR600ATD25](#) [KMZ1608DHR121CTDH5](#) [KMZ1608AHR252BTD25](#) [KMZ1608YHR102BTD25](#)
[KMZ1608BHR102CTD25](#) [KMZ1608YHR600BTD25](#) [KMZ1608RHR121ATD25](#) [KMZ1608SHR601ATD25](#)
[KMZ1608SHR102ATD25](#) [KMZ1608YHR301BTD25](#) [KMZ1608DHR500CTDH5](#) [KMZ1608YHR152BTD25](#)
[KMZ1608YHR121BTD25](#) [KMZ1608BHR601CTDH5](#) [KMZ1608YHR601BTD25](#) [KMZ1608SHR121ATD25](#)
[KMZ1608DHR241CTD25](#) [KMZ1608RHR102ATD25](#) [KMZ1608RHR601ATD25](#)