

# SK6018

## GENERAL DESCRIPTION

The SK6018 series are low dropout linear regulators and optimized to provide a high performance solution for battery power system to delivery low quiescent current. The device offer a new level of cost effective performance in cellular phones, laptop and notebook computers, and other portable devices.

SK6018 can provide output value in the range of 1.2V~3.6V by every 0.1V step.

The SK6018 series are designed to make use of low cost ceramic capacitors which ensure the stability of the output current, and enhance the efficiency in order to prolong the battery life of those portable devices.

The SK6018 regulators are available in DFN1x1\_4L packages. Standard products are Pb-free and Halogen-free.

## FEATURES

- Input voltage: 2.5V~6.5V
- Output range: 1.2V~3.6V (customized by every 0.1V step)
- Output current: 300mA @  $V_{IN}-V_{OUT}=0.5V$
- Dropout voltage: 100mV @  $I_{OUT}=100mA$
- Quiescent current : 1 $\mu$ A Typ.
- Recommend capacitor: 1 $\mu$ F

## APPLICATIONS

- Reference voltage source
- Toys
- Bluetooth, wireless handsets
- Low Consumption Device
- Others portable electronic device

## TYPICAL APPLICATION CIRCUIT

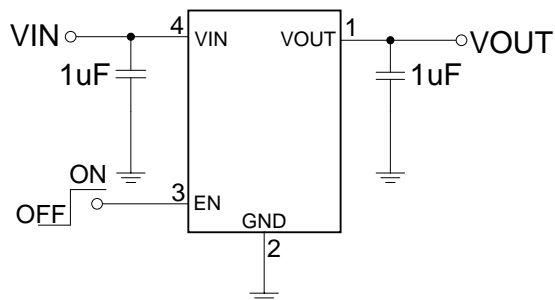

## PIN ASSIGNMENT

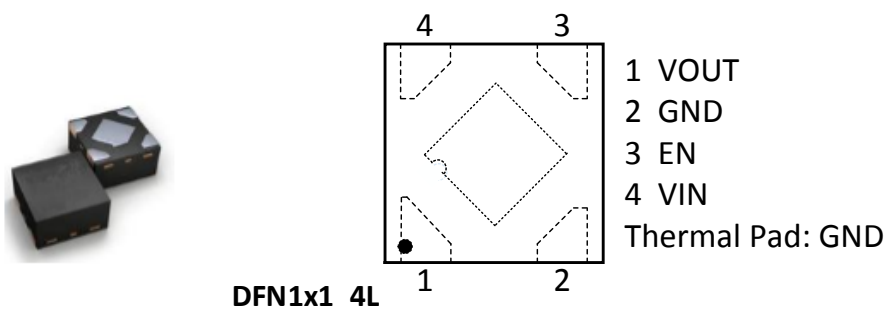

## ORDER INFORMATION

PART NO	ACCURACY	PACAKGE	TEMPERATURE	TAPE & REEL
SK6018D4-XX	2%	DFN1x1_4L	-40 ~ +85°C	10000/REEL

**Note:**XX indicates 1.2V~3.6V by 0.1V step. For example, 33 means product outputs 3.3V.

## PART NUMBER RULES

SK6018<sup>[1]</sup>-<sup>[2]</sup>

Code	Description
[1]	Package: D4: DFN1x1_4L
[2]	Voltage version: XX: 1.2V~3.6V in 0.1V step Example: 33: 3.3V

## MARKING DESCRIPTION:

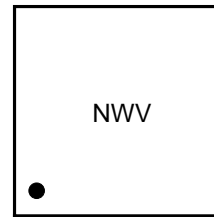

“N”: Product code, here use “U” stands for “SK6018”.

“W”: The week of manufacturing. “A” stands for week 1, “Z” stands for week 26, “ $\bar{A}$ ” stands for week 27, “ $\bar{Z}$ ” stands for week 52.

“V”: Product version code.

## PIN DESCRIPTION

PIN NO	SYMBOL	I/O	DESCRIPTION
DFN1x1_4L			
1	VOUT	O	Output
2	GND	GND	Ground
3	EN	I	Enable(Active high, not floating)
4	VIN	Power	Input

## ABSOLUTE MAXIMUM RATINGS(Note)

SYMBOL	ITEMS	VALUE	UNIT
$V_{IN}$	Input Voltage	-0.3~8	V
$I_{OUT}$	Output Current	350	mA
$P_{DMAX}$	Power Dissipation	DFN1x1_4L 0.6	W
$R_{\theta JA}$	Thermal Resistance	DFN1x1_4L 250	°C/W
$T_J$	Junction Temperature	-40~125	°C
$T_A$	Ambient Temperature	-40~85	°C
$T_{STG}$	Storage Temperature	-55~150	°C
$T_{SOLDER}$	Package Lead Soldering Temperature (10s)	260	°C

**Note:** Exceed these limits to damage to the device. Exposure to absolute maximum rating conditions may affect device reliability.

## RECOMMENDED OPERATING RANGE

SYMBOL	ITEMS	VALUE	UNIT
$V_{IN}$	Supply Voltage	2.5 to 6.5	V
$T_{OPT}$	Operating Temperature	-40 to +85	°C

## ELECTRICAL CHARACTERISTICS

The following specifications apply for  $V_{OUT}=3.3V$ ,  $T_A=25^{\circ}C$ , unless otherwise noted.

SYMBOL	ITEMS	CONDITIONS	MIN	TYP	MAX	UNIT
$V_{IN}$	Input Voltage				6.5	V
$V_{OUT}$	Output Voltage	$I_{OUT}=1mA$	-2	$V_{OUT}$	2	%
$I_Q$	Quiescent Current	$V_{OUT}=3.3V, I_{OUT}=0$		1	2	$\mu A$
$I_{LIMIT}$	Current Limit	$V_{IN}-V_{OUT}=0.5V$		350		mA
$V_{DROP}$	Dropout Voltage	$V_{OUT}=3.3V, I_{OUT}=100mA$		110		mV
		$V_{OUT}=3.3V, I_{OUT}=200mA$		230		
$\Delta V_{LINE}$	Line Regulation	$V_{IN}=2.7\sim 5.5V, I_{OUT}=1mA$		0.01		%/V
$\Delta V_{LOAD}$	Load Regulation	$V_{OUT}=3.3V, I_{OUT}=1\sim 300mA$		100		mV
$I_{SHORT}$	Short Current	$V_{EN}=V_{IN}, V_{OUT}$ Short to GND with $1\Omega$		90		mA
$I_{SHDN}$	Shut-down Current	$V_{EN}=0V$		0.1	1	$\mu A$
$V_{ENH}$	EN Logic High Voltage	$V_{IN}=5.5V, I_{OUT}=1mA$	1.2		$V_{IN}$	V
$V_{ENL}$	EN Logic Low Voltage	$V_{IN}=5.5V, V_{OUT}=0V$			0.4	V
$I_{EN}$	EN Input Current	$V_{EN}=0$ to 5.5V			1.0	$\mu A$

## SIMPLIFIED BLOCK DIAGRAM

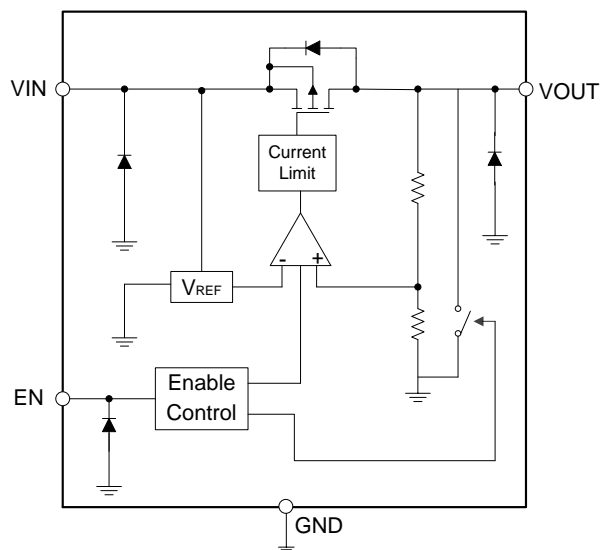

## TYPICAL PERFORMANCE CHARACTERISTICS

$C_{IN}=1\mu F$ ,  $C_{OUT}=1\mu F$ ,  $T_{OPT}=25^{\circ}C$ ,  $V_{IN}=5V$ ,  $V_{OUT}=3.3V$ , unless otherwise noted.

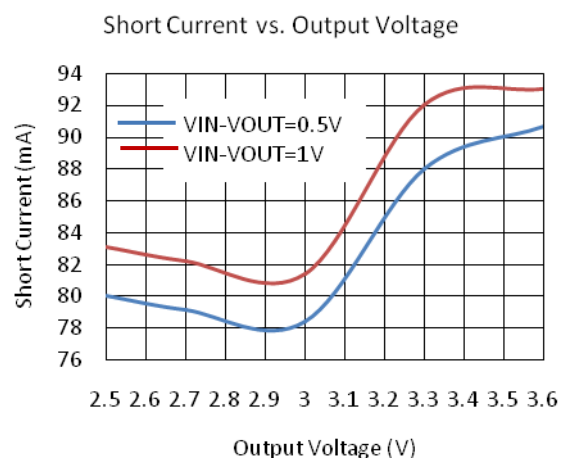
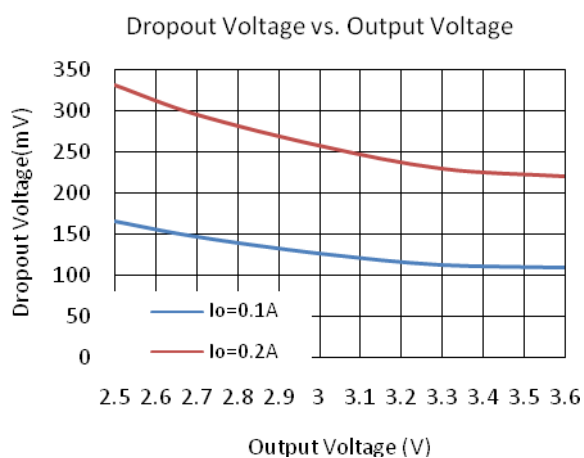
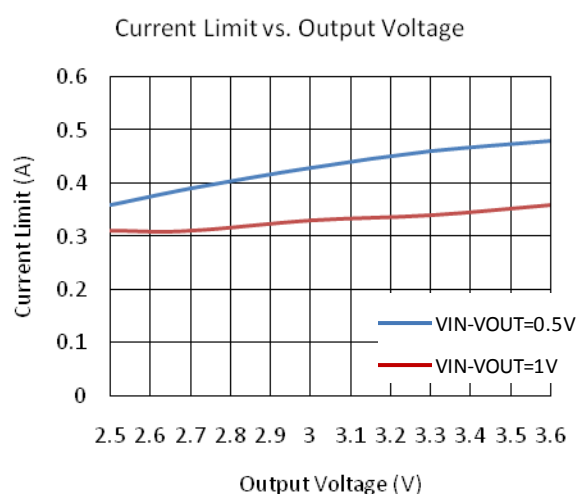
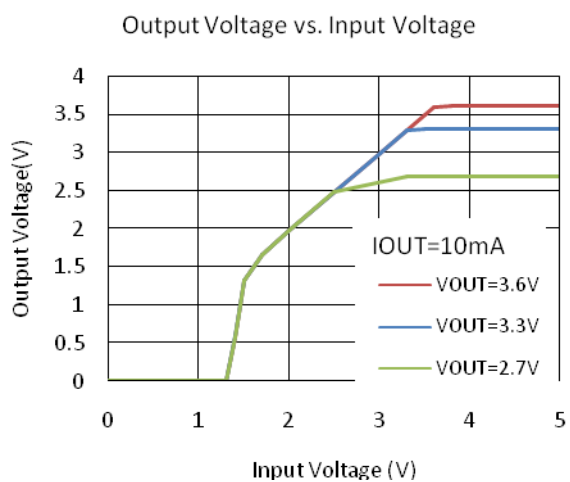
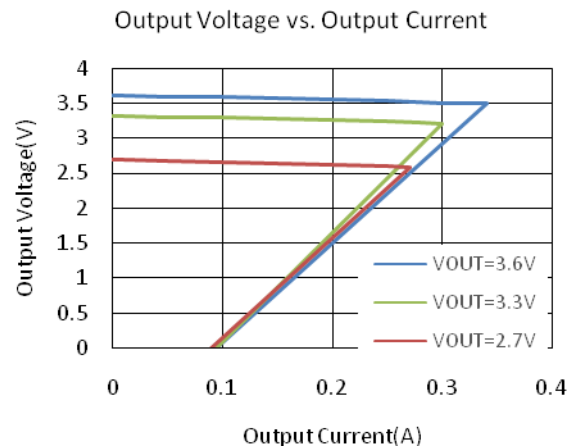
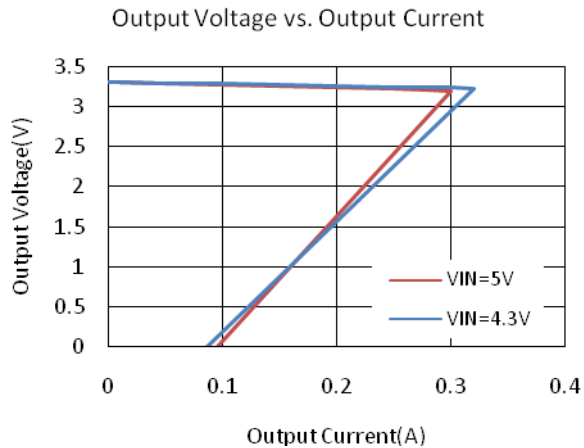

## Line Transient Response

CH1:V<sub>IN</sub> CH2:V<sub>OUT</sub>

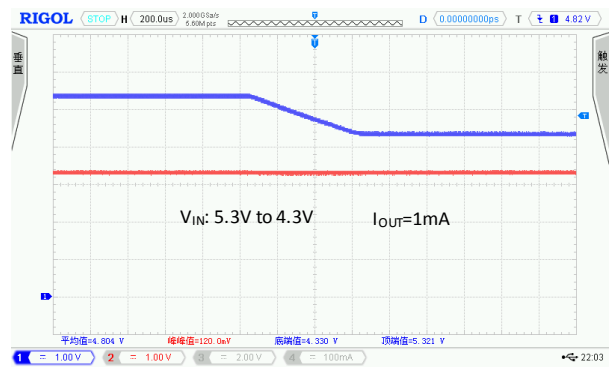
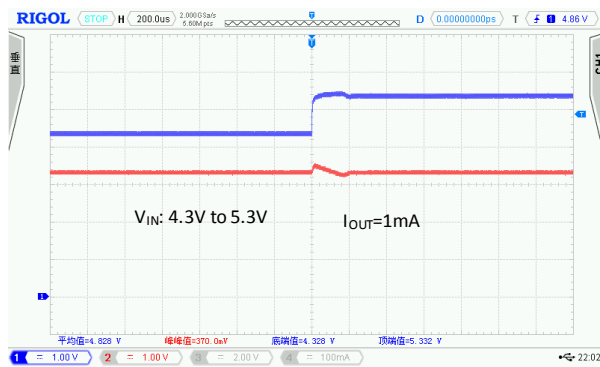
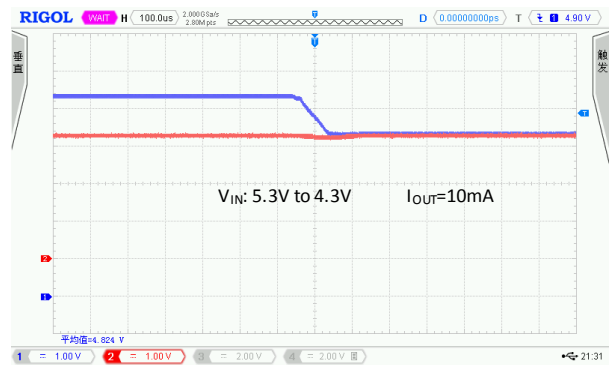
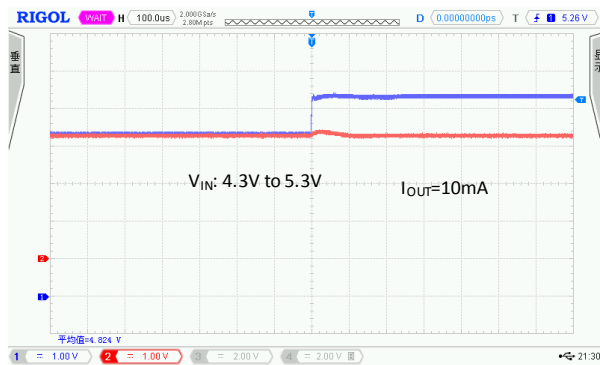

## Load Transient Response

CH1:V<sub>IN</sub>CH2:V<sub>OUT</sub>CH3:I<sub>OUT</sub>

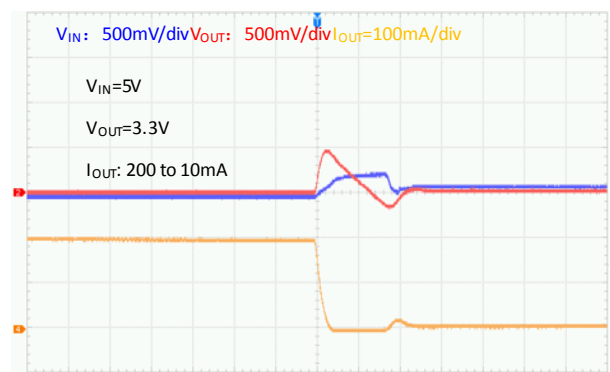
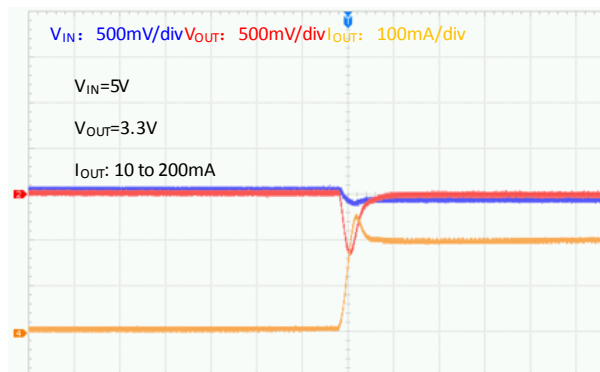

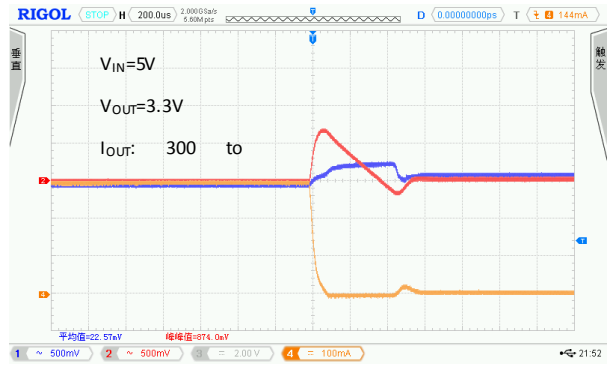
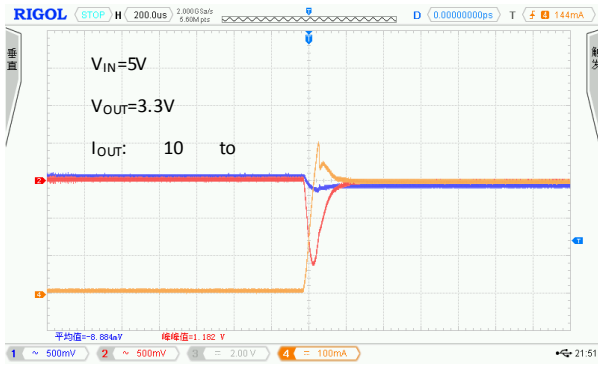

## Load Transient Response

CH1:V<sub>IN</sub>CH2:V<sub>OUT</sub>CH3:I<sub>OUT</sub>

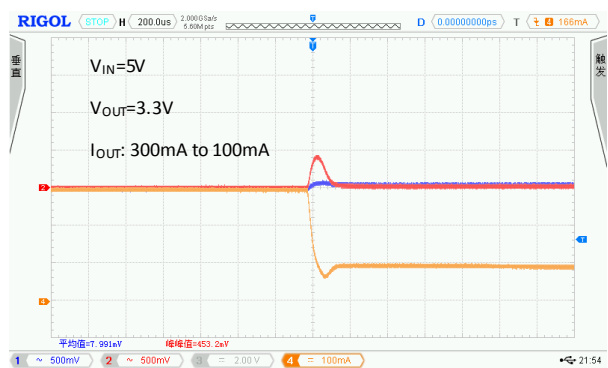
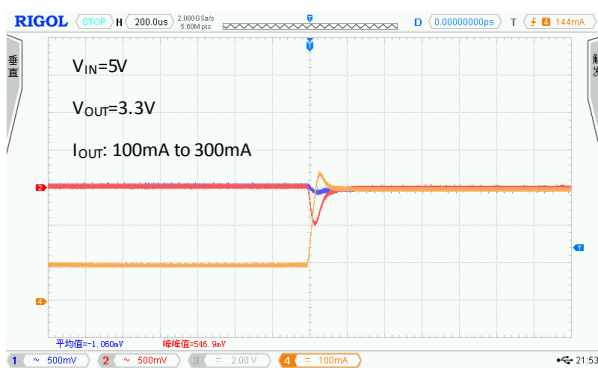
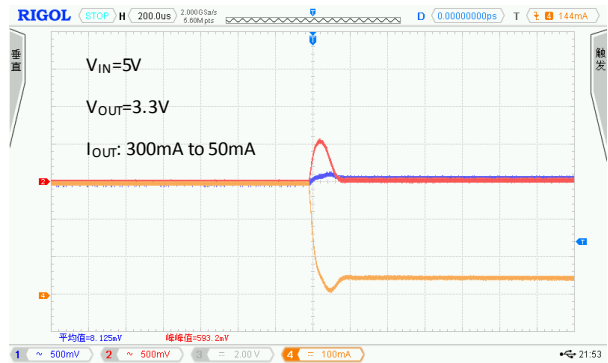

## PACKAGE OUTLINE

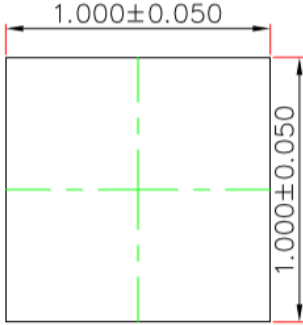
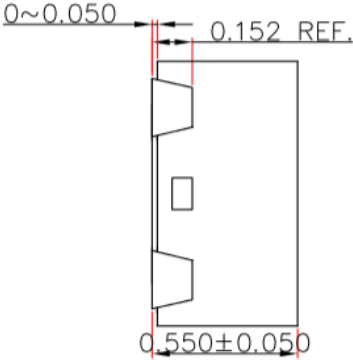
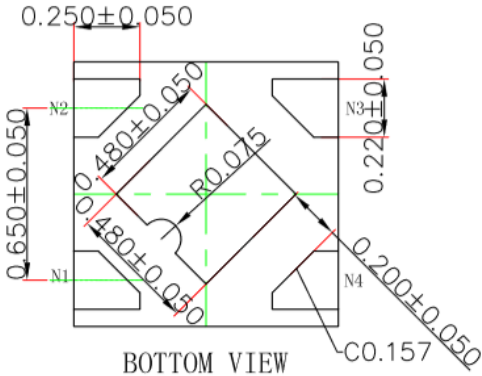
Package	DFN1x1_4L	Devices per reel	10000Pcs	Unit	mm
Package Dimension:					
 <p style="text-align: center;">TOP VIEW [顶视图]</p>		 <p style="text-align: center;">SIDE VIEW 侧视图</p>			
 <p style="text-align: center;">BOTTOM VIEW 背视图</p>					