

# SMD Power Inductor CD54/T125



## Description

- Ferrite drum core construction.
- Magnetically unshielded.
- L × W × H: 6.1 × 5.5 × 4.85mm Max.
- Product weight 0.4g(Ref.)
- Moisture Sensitivity Level: 1
- RoHS compliance.
- Qualification to AEC-Q200.

## Dimension - [mm]

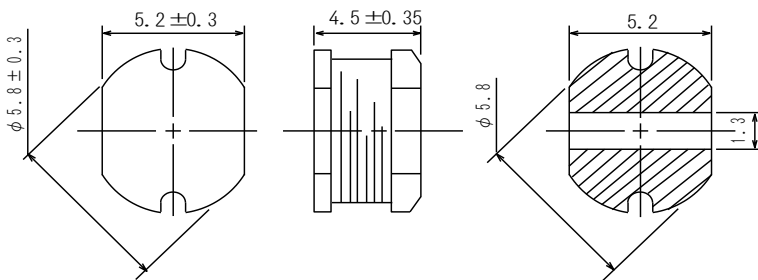

## Land pattern and Schematics - [mm]

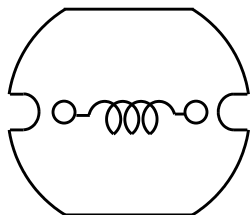
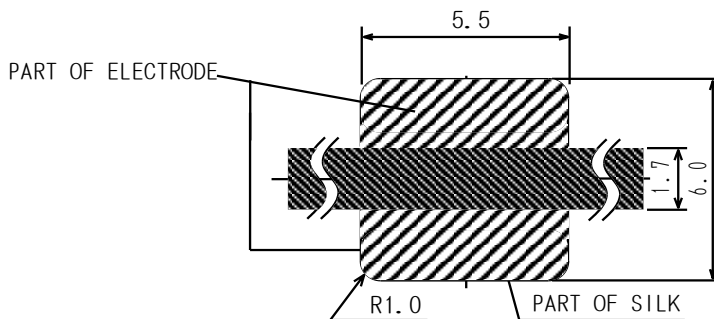

## Environmental Data

- Operating temperature range: -40°C ~ +125°C (including coil's self temperature rise)
- Storage temperature range: -40°C ~ +125°C
- Solder reflow temperature: 260 °C peak.

## Packaging

- Carrier tape and reel packaging.
- 13.0" diameter reel
- 1500pcs per reel

## Applications

- Automotive and other high temperature, high reliability application.



### Electrical Characteristics

Part No.	Stamp	Inductance [Within] ※1	D.C.R. ( $\Omega$ ) (Max.) (at 20°C)	Saturation current (A) ※2	Temperature rise current (A) ※3
CD54T125NP-100MC	100	10 $\mu$ H $\pm$ 20%	0.10	1.94	2.55
CD54T125NP-120MC	120	12 $\mu$ H $\pm$ 20%	0.12	1.82	2.45
CD54T125NP-150MC	150	15 $\mu$ H $\pm$ 20%	0.14	1.58	2.15
CD54T125NP-180MC	180	18 $\mu$ H $\pm$ 20%	0.15	1.49	1.93
CD54T125NP-220MC	220	22 $\mu$ H $\pm$ 20%	0.18	1.44	1.75
CD54T125NP-270MC	270	27 $\mu$ H $\pm$ 20%	0.20	1.28	1.65
CD54T125NP-330LC	330	33 $\mu$ H $\pm$ 15%	0.23	1.16	1.47
CD54T125NP-390LC	390	39 $\mu$ H $\pm$ 15%	0.32	1.02	1.27
CD54T125NP-470LC	470	47 $\mu$ H $\pm$ 15%	0.37	0.91	1.21
CD54T125NP-560KC	560	56 $\mu$ H $\pm$ 10%	0.42	0.88	1.15
CD54T125NP-680KC	680	68 $\mu$ H $\pm$ 10%	0.46	0.80	1.12
CD54T125NP-820KC	820	82 $\mu$ H $\pm$ 10%	0.60	0.71	0.97
CD54T125NP-101KC	101	100 $\mu$ H $\pm$ 10%	0.70	0.65	0.77
CD54T125NP-121KC	121	120 $\mu$ H $\pm$ 10%	0.93	0.60	0.74
CD54T125NP-151KC	151	150 $\mu$ H $\pm$ 10%	1.10	0.55	0.72
CD54T125NP-181KC	181	180 $\mu$ H $\pm$ 10%	1.38	0.50	0.61
CD54T125NP-221KC	221	220 $\mu$ H $\pm$ 10%	1.57	0.45	0.59

※1 Measured frequency Inductance 10 $\mu$ H ~ 82 $\mu$ H ; at 2.52 MHz  
100 $\mu$ H ~ 220 $\mu$ H ; at 1 kHz

※2 Saturation current: This indicates the actual value of D.C. current when the inductance becomes 10% lower than its initial value(Ta=20°C).

※3 Temperature rise current: The actual value of D.C. current when the temperature of coil becomes  $\Delta T=40^\circ\text{C}$  (Ta=20°C).

# SMD Power Inductor CD54/T125



## Saturation Current & Temperature Rise Graph

— L (20°C) — L (105°C) —  $\Delta T$

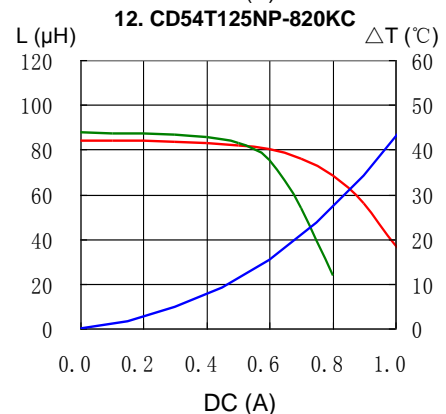
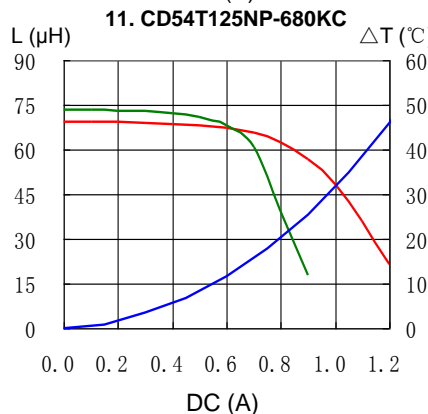
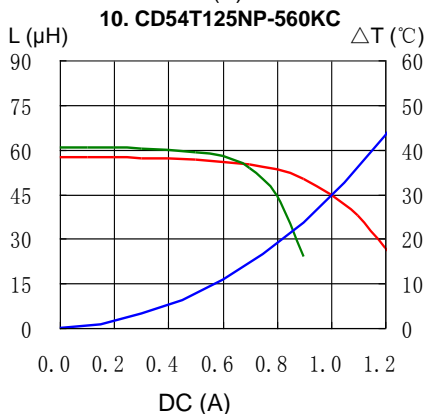
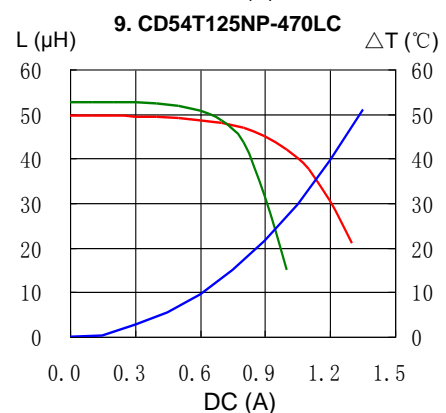
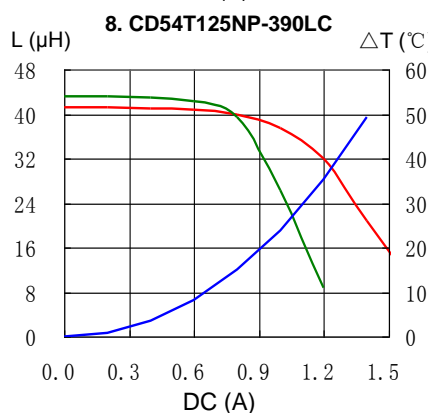
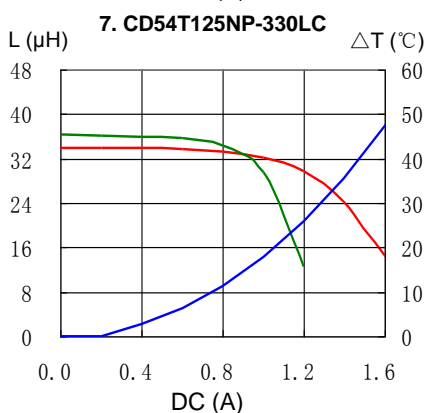
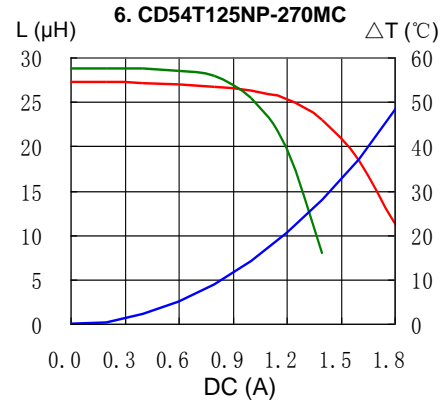
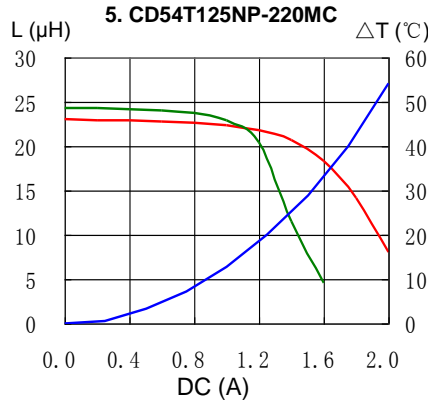
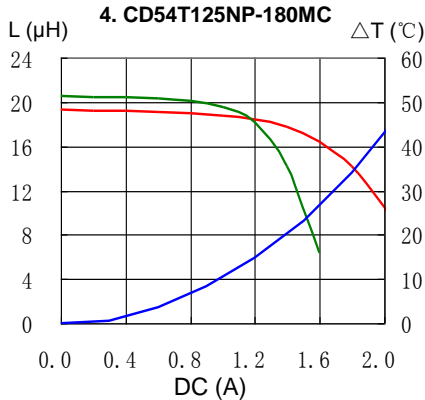
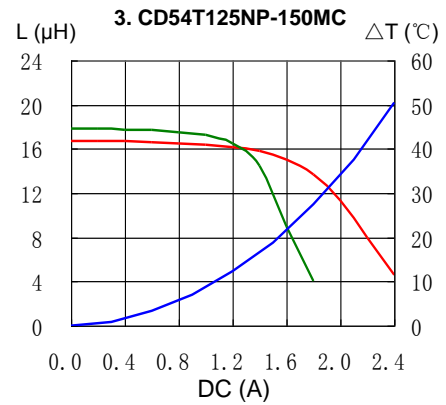
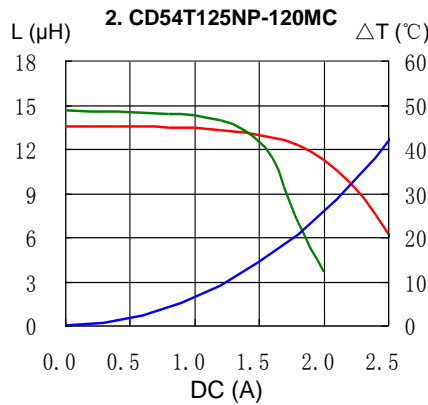
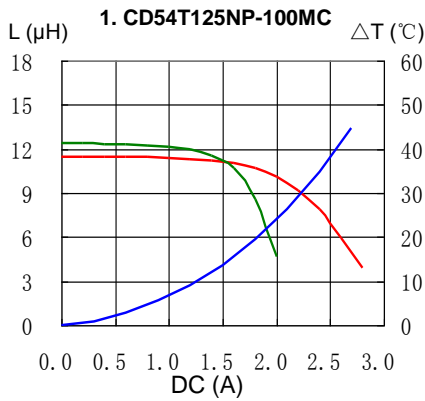

# SMD Power Inductor CD54/T125

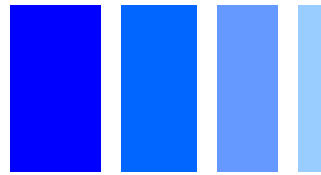

## Saturation Current & Temperature Rise Graph

— L (20°C) — L (105°C) —  $\Delta T$

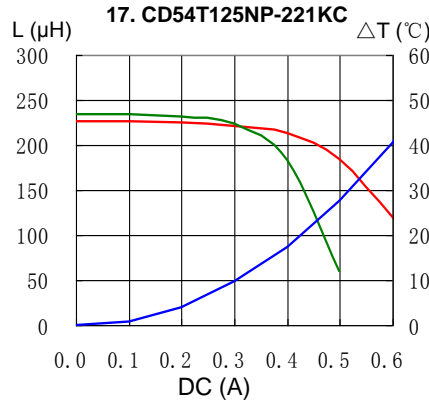
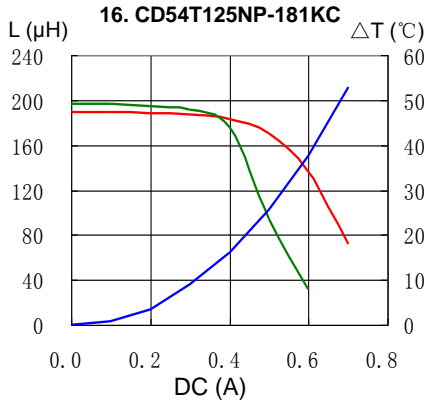
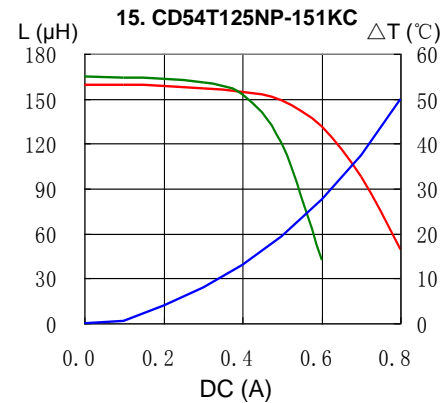
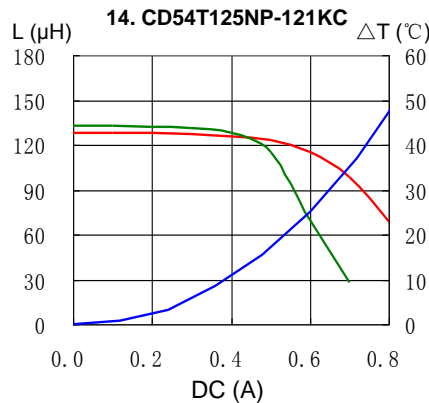
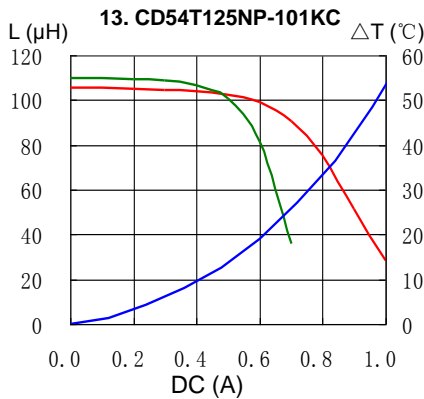

## Solder Reflow Condition

Heat Endurance

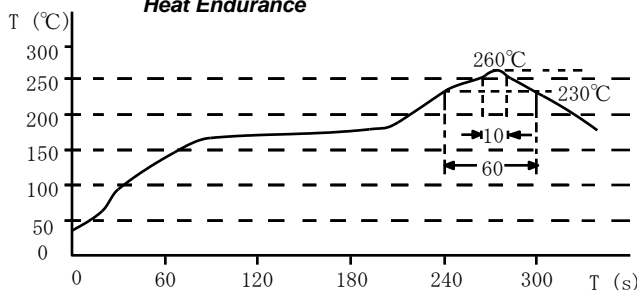

Temperature Chart

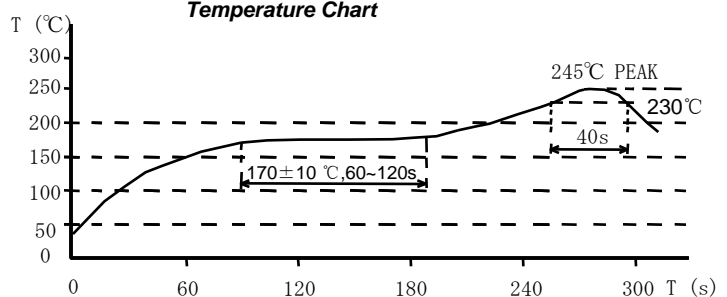

Please refer to the sales offices on our website - <http://www.sumida.com>

### Hong Kong

Tel.+852-2880-6781  
FAX.+852-2565-9600  
[sales@hk.sumida.com](mailto:sales@hk.sumida.com)

### Saitama(Japan)

Tel.+81-48-691-7300  
FAX.+81-48-691-7340  
[sales@jp.sumida.com](mailto:sales@jp.sumida.com)

### Chicago

Tel.+1-847-545-6700  
FAX. +1-847-545-6720  
[sales@us.sumida.com](mailto:sales@us.sumida.com)

### Shanghai

Tel.+86-21-5836-3299  
FAX.+86-21-5836-3266  
[shanghai.sales@cn.sumida.com](mailto:shanghai.sales@cn.sumida.com)

### Seoul

Tel.+82-2-6237-0777  
FAX.+82-2-6237-0778  
[sales@kr.sumida.com](mailto:sales@kr.sumida.com)

### Obernzell

Tel.+49-8591-937-0  
FAX. +49-8591-937-103  
[contact@eu.sumida.com](mailto:contact@eu.sumida.com)

### Shenzhen

Tel.+86-755-8291-0228  
FAX.+86-755-8291-0338  
[shenzhen.sales@cn.sumida.com](mailto:shenzhen.sales@cn.sumida.com)

### Singapore

Tel.+65-6296-3388  
FAX.+65-6841-4426  
[sales@sg.sumida.com](mailto:sales@sg.sumida.com)

### Neumarkt

Tel.+49-9181-4509-110  
FAX. +49-9181-4509-310  
[infocomp@eu.sumida.com](mailto:infocomp@eu.sumida.com)

### Taipei

Tel.+886-2-8751-2737  
FAX.+886-2-8751-2738  
[sales@tw.sumida.com](mailto:sales@tw.sumida.com)

### San Jose

Tel.+1-408-321-9660  
FAX.+1-408-321-9308  
[sales@us.sumida.com](mailto:sales@us.sumida.com)