

# SMD Power Inductor

## CD105/T125



### Description

- Ferrite durm core construction
- Magnetically unshielded
- LxWxH: 10.4x9.4x5.8mm Max.
- Product weight:1.3 g(Ref.)
- Moisture Sensivity Level: 1
- Qualification to AEC-Q200



### Environmental Data

- Operating Temperature: -40°C to +125°C (including self-heating)
- Storage temperature range: -40°C~+125°C

### Packaging

- Carrier tape and reel packaging

### Applications

- High temp and high reliability automotive applications

### Dimension - [mm]

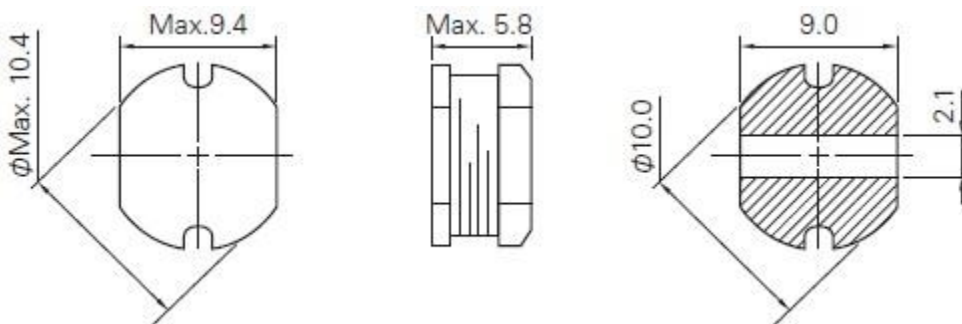

### Recommended Land pattern - [mm]

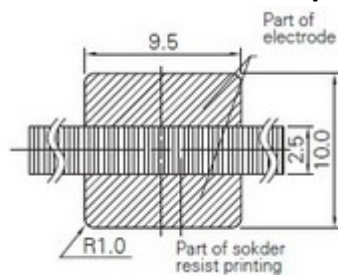

### Wire Connection

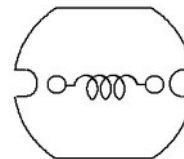

# SMD Power Inductor

## CD105/T125



### Electrical Characteristics

Part Number	Inductance [Within] ( $\mu$ H) ※1	D.C.R. at 20°C Max.(Typ.) (m $\Omega$ )	Saturation Current (A) Max.(Typ.) ※2	Temperature Rise Current (A) Max.(Typ.) ※3
CD105T125NP-100MC	10.00 $\pm$ 20%	60.00 (30.00)	3.20 (4.00)	3.47 (4.00)
CD105T125NP-120MC	12.00 $\pm$ 20%	70.00 (37.00)	2.83 (3.54)	3.37 (3.93)
CD105T125NP-150MC	15.00 $\pm$ 20%	80.00 (43.00)	2.54 (3.17)	3.10 (3.57)
CD105T125NP-180MC	18.00 $\pm$ 20%	90.00 (46.00)	2.40 (3.00)	3.00 (3.50)
CD105T125NP-220MC	22.00 $\pm$ 20%	100 (57.00)	2.13 (2.66)	2.90 (3.30)
CD105T125NP-270MC	27.00 $\pm$ 20%	110 (71.00)	1.96 (2.45)	2.50 (2.84)
CD105T125NP-330MC	33.00 $\pm$ 20%	120 (83.00)	1.76 (2.20)	2.25 (2.58)
CD105T125NP-390MC	39.00 $\pm$ 20%	140 (91.00)	1.62 (2.02)	2.24 (2.55)
CD105T125NP-470KC	47.00 $\pm$ 10%	170 (112)	1.54 (1.92)	1.99 (2.25)
CD105T125NP-560KC	56.00 $\pm$ 10%	190 (127)	1.45 (1.81)	1.80 (2.06)
CD105T125NP-680KC	68.00 $\pm$ 10%	220 (152)	1.32 (1.65)	1.55 (1.80)
CD105T125NP-820KC	82.00 $\pm$ 10%	250 (176)	1.20 (1.50)	1.54 (1.76)
CD105T125NP-101KC	100 $\pm$ 10%	350 (242)	1.05 (1.31)	1.23 (1.42)
CD105T125NP-121KC	120 $\pm$ 10%	400 (274)	0.98 (1.22)	1.20 (1.40)
CD105T125NP-151KC	150 $\pm$ 10%	470 (294)	0.88 (1.10)	1.05 (1.20)
CD105T125NP-181KC	180 $\pm$ 10%	630 (430)	0.79 (0.99)	0.98 (1.12)
CD105T125NP-221KC	220 $\pm$ 10%	730 (500)	0.71 (0.89)	0.87 (1.01)
CD105T125NP-271KC	270 $\pm$ 10%	970 (670)	0.65 (0.81)	0.72 (0.83)
CD105T125NP-331KC	330 $\pm$ 10%	1150 (780)	0.58 (0.72)	0.67 (0.76)
CD105T125NP-391KC	390 $\pm$ 10%	1300 (880)	0.50 (0.63)	0.56 (0.65)
CD105T125NP-471KC	470 $\pm$ 10%	1480 (1000)	0.48 (0.60)	0.53 (0.61)
CD105T125NP-561KC	560 $\pm$ 10%	1900 (1280)	0.45 (0.56)	0.52 (0.59)
CD105T125NP-681KC	680 $\pm$ 10%	2250 (1480)	0.42 (0.52)	0.48 (0.56)
CD105T125NP-821KC	820 $\pm$ 10%	2550 (1690)	0.38 (0.48)	0.47 (0.54)

Note: This specification is subject to change without notice. Please contact your nearest sales office for updated information when placing an order.

# SMD Power Inductor

## CD105/T125



※1 Measuring frequency  $10\ \mu\text{H} \sim 82\ \mu\text{H}$  at 2.52 MHz;  $100\ \mu\text{H} \sim 820\ \mu\text{H}$  at 1 kHz

※2 Saturation current: This indicates the actual value of D.C. current when the inductance becomes 10% lower than its initial value. ( $T_a=20^\circ\text{C}$ )

※3 Temperature rise current: The actual value of D.C. current when the temperature of coil becomes  $\Delta T=40^\circ\text{C}$  ( $T_a=20^\circ\text{C}$ ).

### Solder Reflow Condition

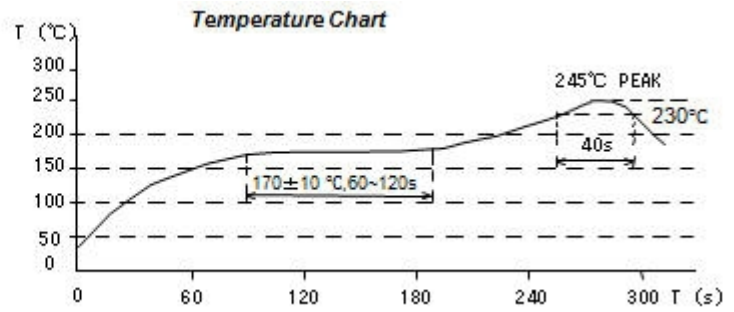
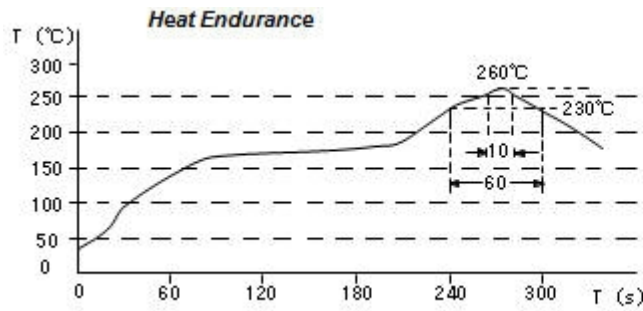

# SMD Power Inductor

## CD105/T125



### Saturation Current & Temperature Rise Graph

— L (20°C) — L (105°C) —  $\Delta T$

1. CD105T125NP-100MC

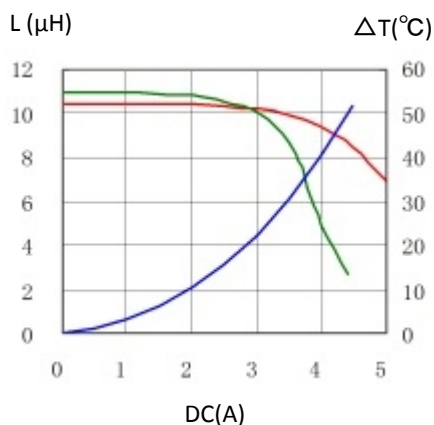

2. CD105T125NP-120MC

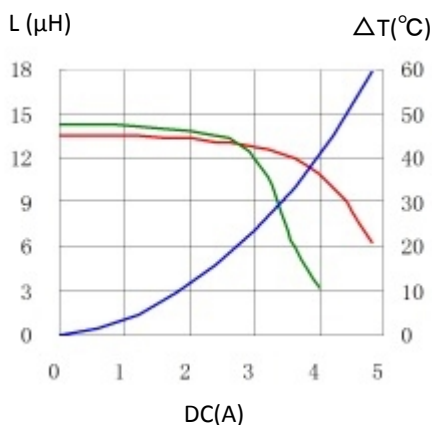

3. CD105T125NP-150MC

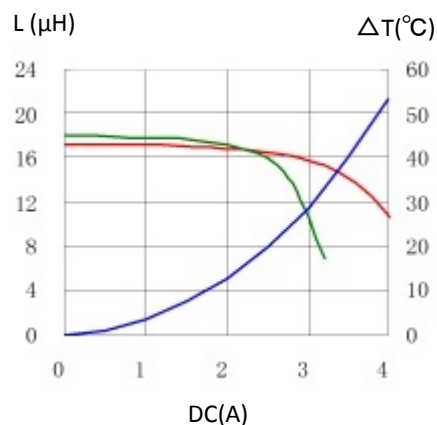

4. CD105T125NP-180MC

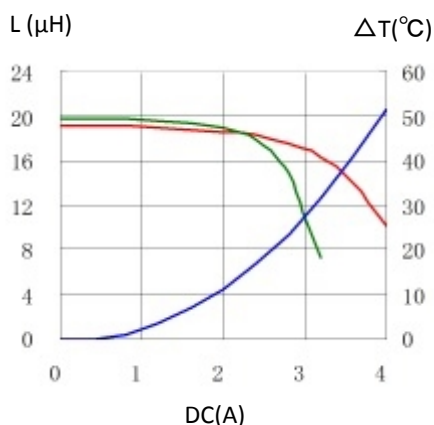

5. CD105T125NP-220MC

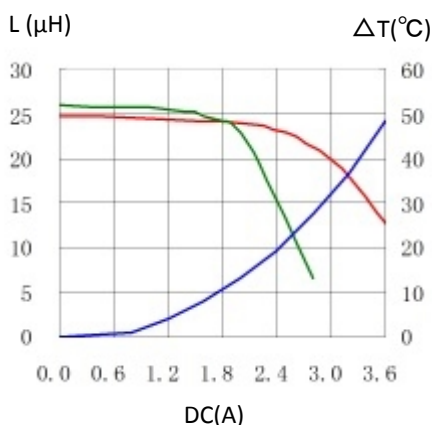

6. CD105T125NP-270MC

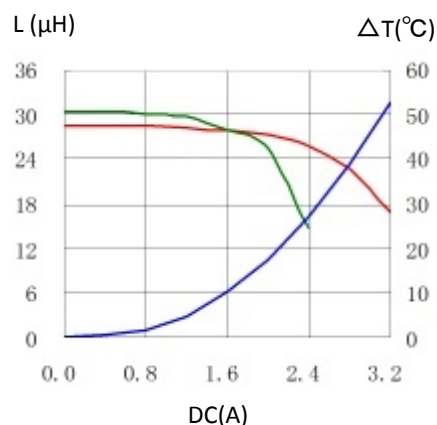

7. CD105T125NP-330MC

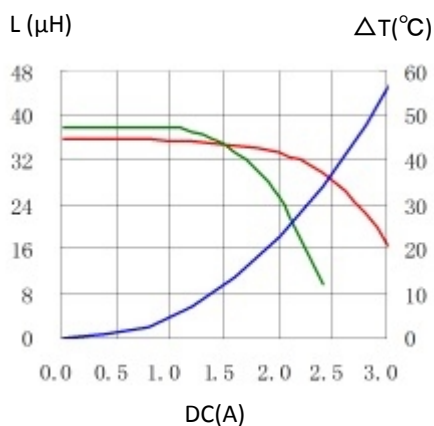

8. CD105T125NP-390MC

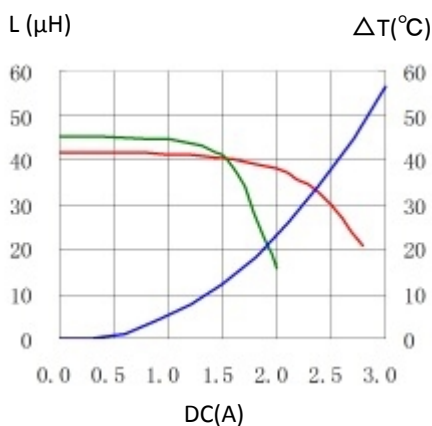

9. CD105T125NP-470KC

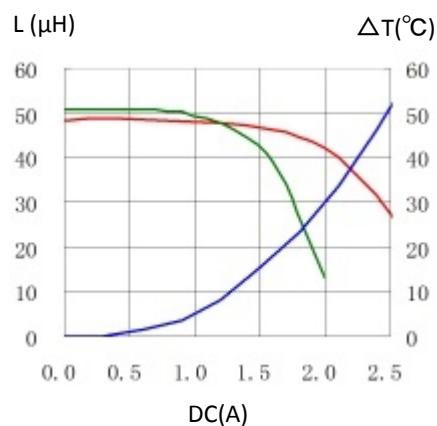

Note: This specification is subject to change without notice. Please contact your nearest sales office for updated information when placing an order.

# SMD Power Inductor

## CD105/T125



10. CD105T125NP-560KC

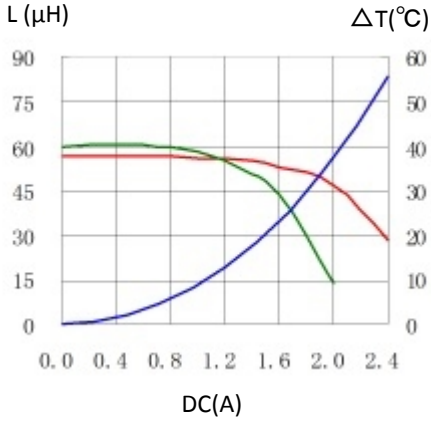

11. CD105T125NP-680KC

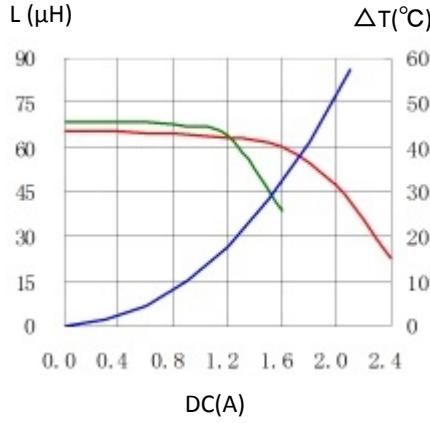

12. CD105T125NP-820KC

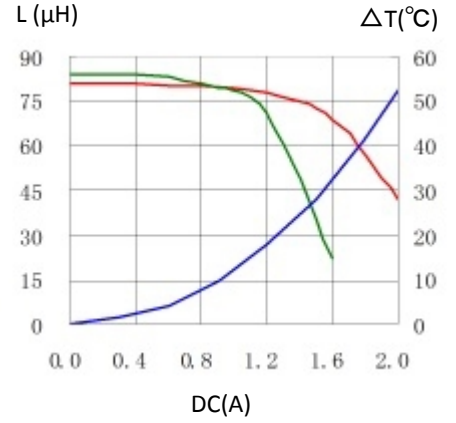

13. CD105T125NP-101KC

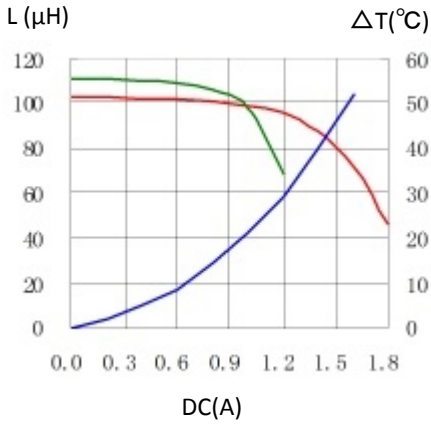

14. CD105T125NP-121KC

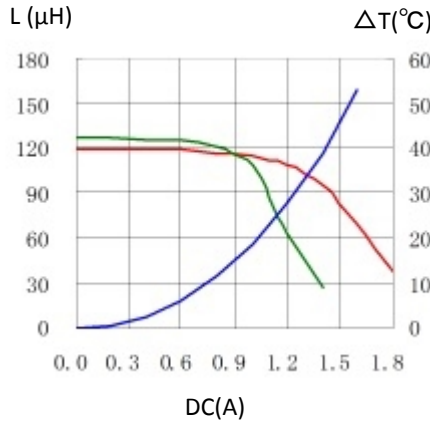

15. CD105T125NP-151KC

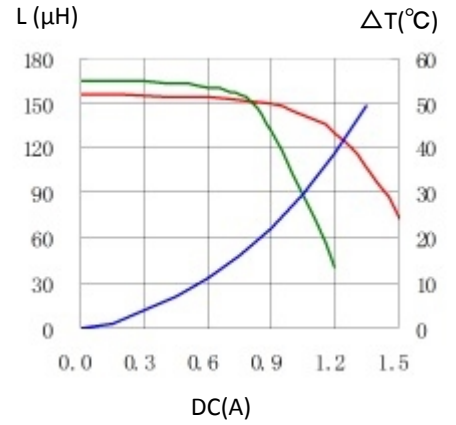

16. CD105T125NP-181KC

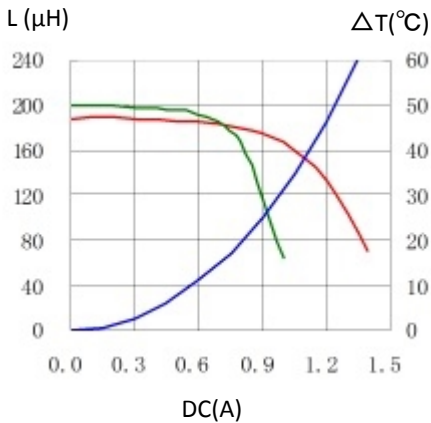

17. CD105T125NP-221KC

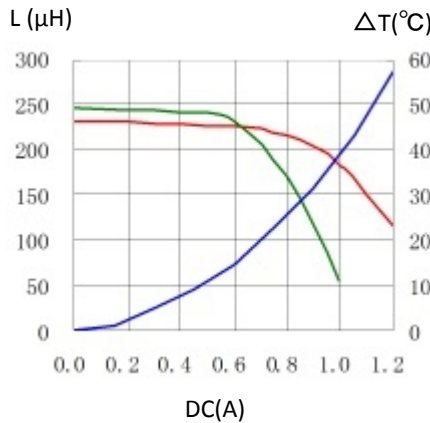

18. CD105T125NP-271KC

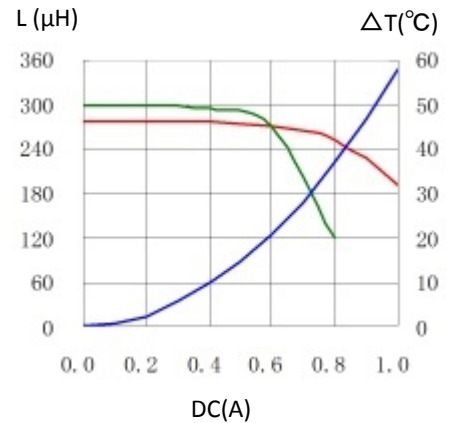

# SMD Power Inductor

## CD105/T125



19. CD105T125NP-331KC

20. CD105T125NP-391KC

21. CD105T125NP-471KC

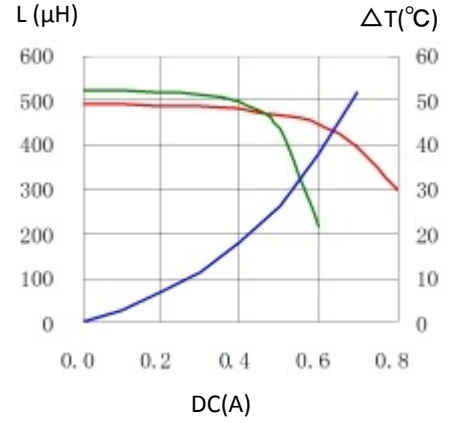
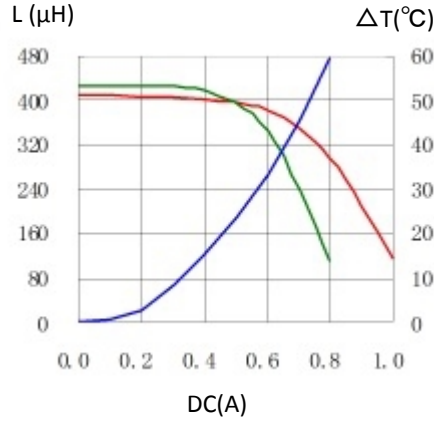
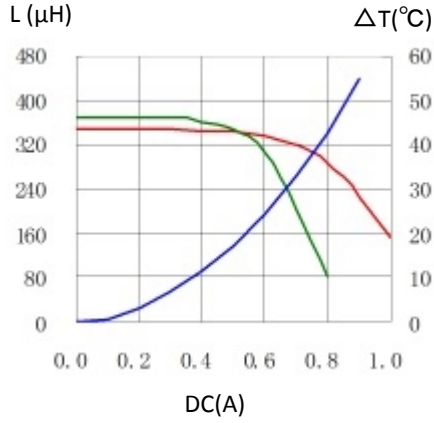

22. CD105T125NP-561KC

23. CD105T125NP-681KC

24. CD105T125NP-821KC

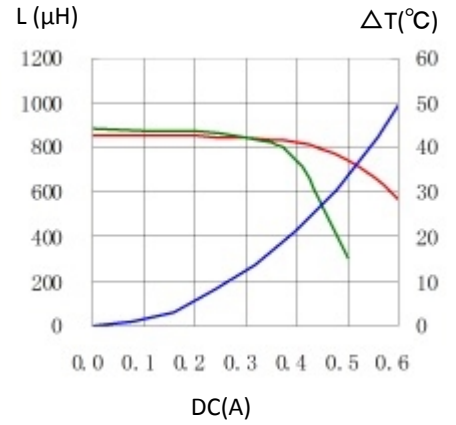
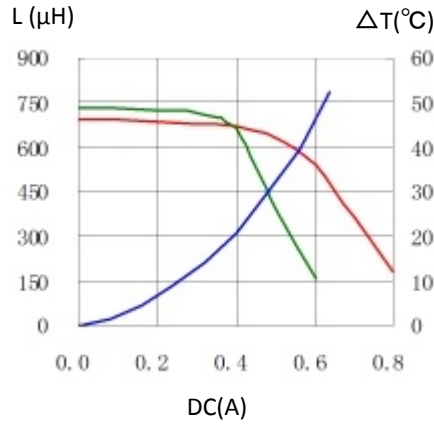
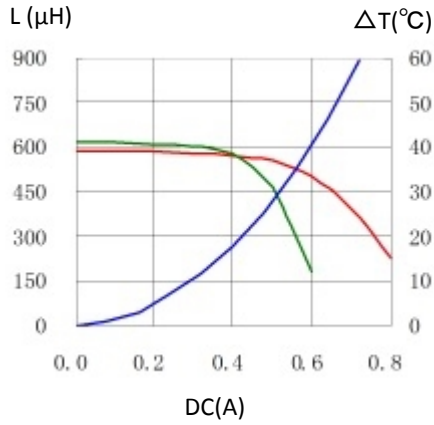

For sales office information, please [click here](#) to visit our website.