

## Surface Mount Schottky Barrier Rectifier

Reverse Voltage - 20 to 200V Forward Current - 5.0A

### FEATURES

- Metal silicon junction, majority carrier conduction
- For surface mounted applications
- Low power loss, high efficiency
- High forward surge current capability
- For use in low voltage, high frequency inverters, free wheeling, and polarity protection applications

### MECHANICAL DATA

- Case: SMBF
- Terminals: Solderable per MIL-STD-750, Method 2026
- Approx. Weight: 57mg / 0.002oz

### Absolute Maximum Ratings and Electrical characteristics

Ratings at 25°C ambient temperature unless otherwise specified. Single phase, half wave, 60Hz resistive or inductive load, for capacitive load, derate by 20 %

### PINNING

PIN	DESCRIPTION
1	Cathode
2	Anode

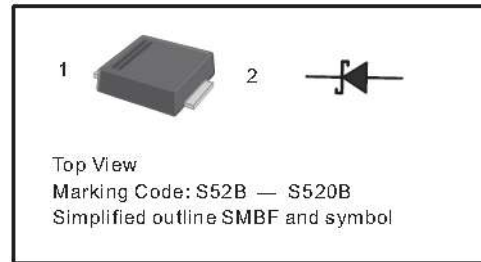

Parameter	Symbol	SS52BF	SS54BF	SS56BF	SS58BF	SS510BF	SS512BF	SS515BF	SS520BF	Units
Maximum Repetitive Peak Reverse Voltage	$V_{RRM}$	20	40	60	80	100	120	150	200	V
Maximum RMS voltage	$V_{RMS}$	14	28	42	56	70	84	105	140	V
Maximum DC Blocking Voltage	$V_{DC}$	20	40	60	80	100	120	150	200	V
Maximum Average Forward Rectified Current	$I_{F(AV)}$	5.0								A
Peak Forward Surge Current, 8.3ms Single Half Sine-wave Superimposed on Rated Load (JEDEC method)	$I_{FSM}$	150								A
Max Instantaneous Forward Voltage at 5 A	$V_F$	0.45	0.55	0.70		0.85				V
Maximum DC Reverse Current $T_a = 25^\circ\text{C}$ at Rated DC Reverse Voltage $T_a = 100^\circ\text{C}$	$I_R$					1.0				mA
						50				
Typical Junction Capacitance <sup>1)</sup>	$C_j$	800		500						pF
Typical Thermal Resistance <sup>2)</sup>	$R_{\theta JA}$	40								°C/W
Operating Junction Temperature Range	$T_j$	-55 ~ +125								°C
Storage Temperature Range	$T_{stg}$	-55 ~ +150								°C

1) Measured at 1MHz and applied reverse voltage of 4 V D.C. 2) P.C.B. mounted with 0.5 X 0.5" (12.7 X 12.7 mm) copper pad areas.

SHIKE MAKE CONSCIOUS PRODUCT

CONSCIOUS PRODUCTS BEGIN WITH CONSCIOUS PEOPLE

REV.07



www.shike.tw

**Fig.1 Forward Current Derating Curve**

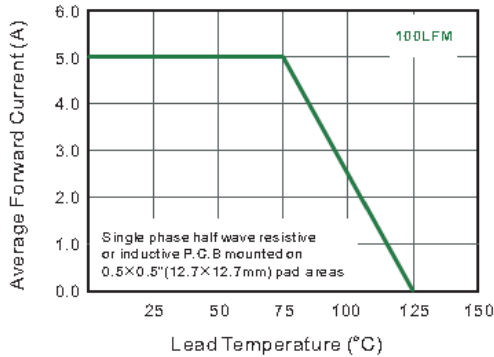

**Fig.2 Typical Reverse Characteristics**

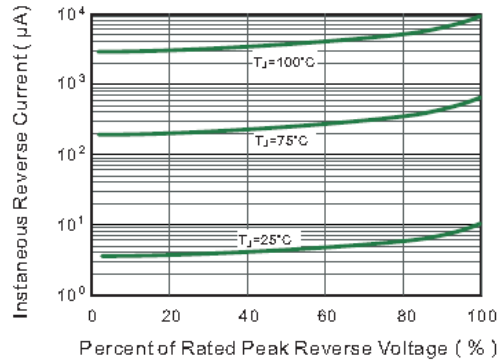

**Fig.3 Typical Forward Characteristic**

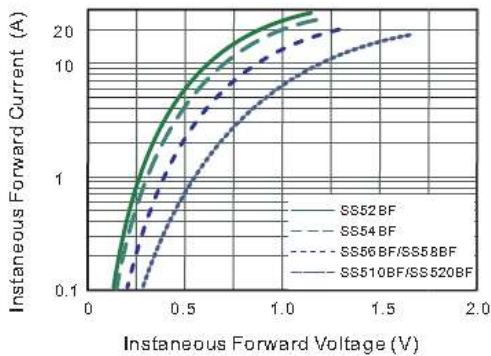

**Fig.4 Typical Junction Capacitance**

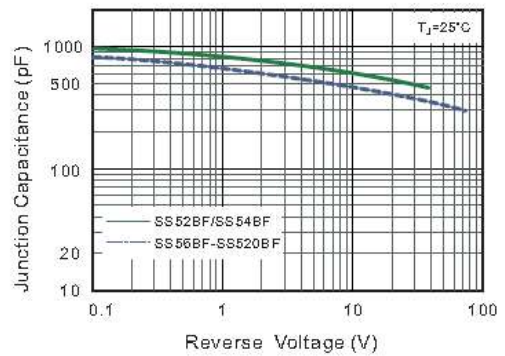

**Fig.5 Maximum Non-Repetitive Peak Forward Surge Current**

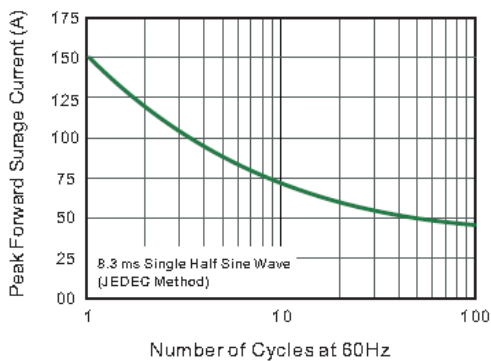

**Fig.6- Typical Transient Thermal Impedance**

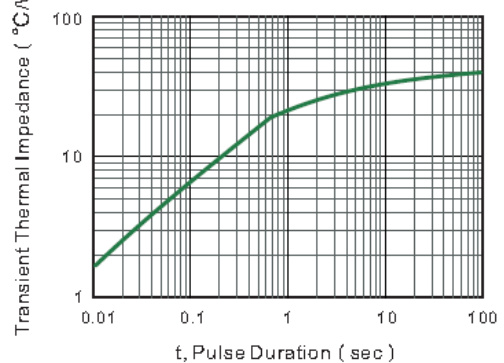

## PACKAGE OUTLINE

Plastic surface mounted package; 2 leads

SMBF

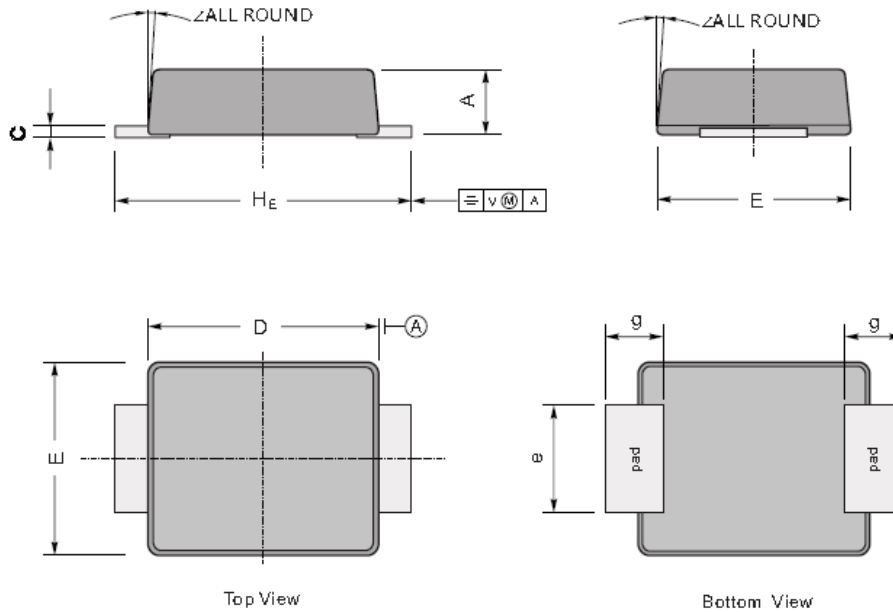

UNIT		A	C	D	E	H <sub>E</sub>	e	g	∠
mm	max	1.3	0.26	4.4	3.7	5.5	2.2	1.0	9°
	min	1.1	0.18	4.2	3.5	5.1	1.9		
mil	max	51	10	173	146	216	86	40	
	min	43	7	165	138	200	75		

### The recommended mounting pad size

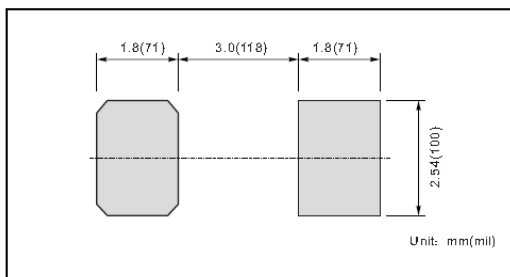

### Marking

Type number	Marking code
SS52BF	S52B
SS54BF	S54B
SS56BF	S56B
SS58BF	S58B
SS510BF	S510B
SS512BF	S512B
SS515BF	S515B
SS520BF	S520B

SHIKE MAKE CONSCIOUS PRODUCT  
CONSCIOUS PRODUCTS BEGIN WITH CONSCIOUS PEOPLE

REV.07

