

Surface Mount Schottky Barrier Rectifier

Reverse Voltage - 20 to 200V Forward Current - 3.0A

FEATURES

- Metal silicon junction, majority carrier conduction
- For surface mounted applications
- Low power loss, high efficiency
- High forward surge current capability
- For use in low voltage, high frequency inverters, free wheeling, and polarity protection applications

MECHANICAL DATA

- Case: SMBF
- Terminals: Solderable per MIL-STD-750, Method 2026
- Approx. Weight: 57 mg / 0.002oz

Absolute Maximum Ratings and Electrical characteristics

Ratings at 25 °C ambient temperature unless otherwise specified. Single phase, half wave, 60Hz resistive or inductive load, for capacitive load, derate by 20 %

PINNING

| PIN | DESCRIPTION |
|-----|-------------|
| 1 | Cathode |
| 2 | Anode |

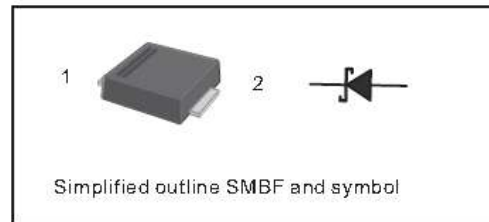

| Parameter | Symbols | SS32BF | SS34BF | SS36BF | SS38BF | SS310BF | SS312BF | SS315BF | SS320BF | Units |
|---|-----------------|------------|--------|--------|----------|---------|---------|---------|---------|-------|
| Maximum Repetitive Peak Reverse Voltage | V_{RRM} | 20 | 40 | 60 | 80 | 100 | 120 | 150 | 200 | V |
| Maximum RMS voltage | V_{RMS} | 14 | 28 | 42 | 56 | 70 | 84 | 105 | 140 | V |
| Maximum DC Blocking Voltage | V_{DC} | 20 | 40 | 60 | 80 | 100 | 120 | 150 | 200 | V |
| Maximum Average Forward Rectified Current | $I_{F(AV)}$ | 3.0 | | | | | | | | A |
| Peak Forward Surge Current, 8.3ms Single Half Sine-wave Superimposed on Rated Load (JEDEC method) | I_{FSM} | 80 | | | | 70 | | | | A |
| Max Instantaneous Forward Voltage at 3 A | V_F | 0.55 | | 0.70 | | 0.85 | | 0.95 | | V |
| Maximum DC Reverse Current $T_a = 25^\circ\text{C}$ at Rated DC Reverse Voltage $T_a = 100^\circ\text{C}$ | I_R | 0.5 5 | | | 0.3 3 | | | | mA | |
| Typical Junction Capacitance ¹⁾ | C_j | 450 | | | 400 | | | | pF | |
| Typical Thermal Resistance ²⁾ | $R_{\theta JA}$ | 50 | | | | | | | | °C/W |
| Operating Junction Temperature Range | T_j | -55 ~ +125 | | | | | | | | °C |
| Storage Temperature Range | T_{sig} | -55 ~ +150 | | | | | | | | °C |

1) Measured at 1MHz and applied reverse voltage of 4 V D.C. 2) P.C.B. mounted with 0.5 X 0.5" (12.7 X 12.7 mm) copper pad areas.

SHIKE MAKE CONSCIOUS PRODUCT

CONSCIOUS PRODUCTS BEGIN WITH CONSCIOUS PEOPLE

REV.07



www.shike.tw

Fig.1 Forward Current Derating Curve

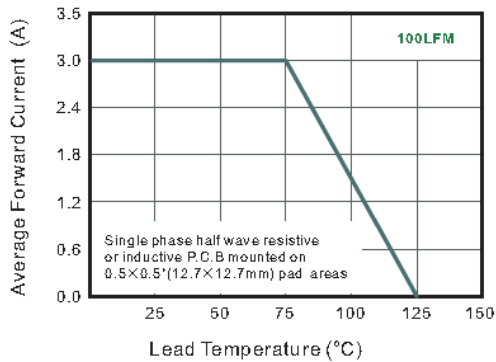

Fig.2 Typical Reverse Characteristics

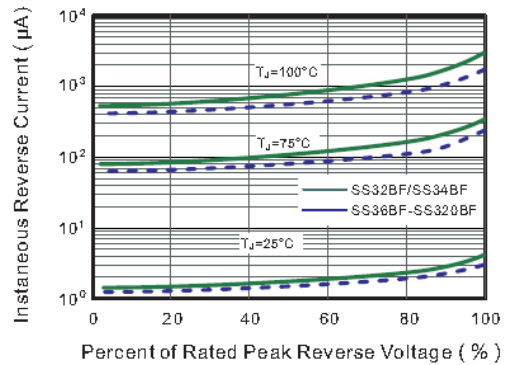

Fig.3 Typical Forward Characteristic

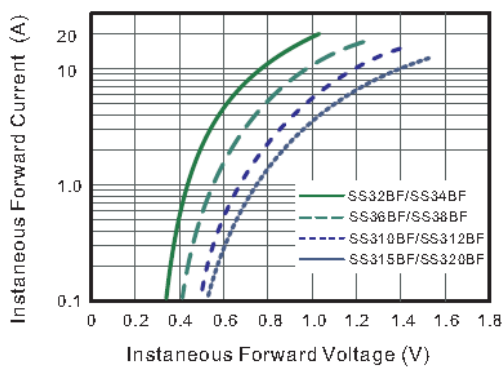

Fig.4 Maximum Non-Repetitive Peak Forward Surge Current

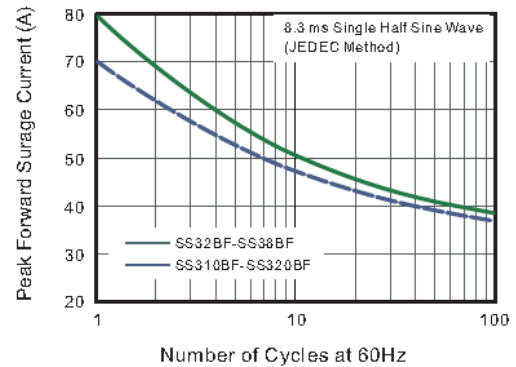
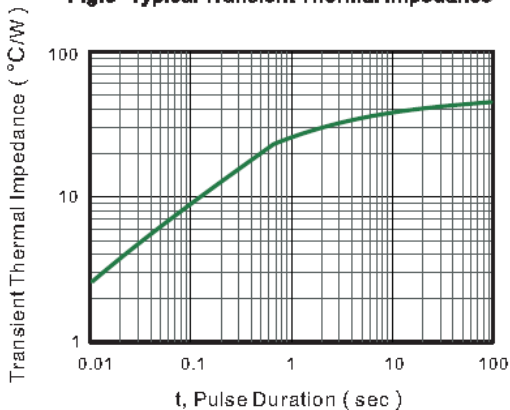

Fig.5- Typical Transient Thermal Impedance



PACKAGE OUTLINE

Plastic surface mounted package; 2 leads

SMBF

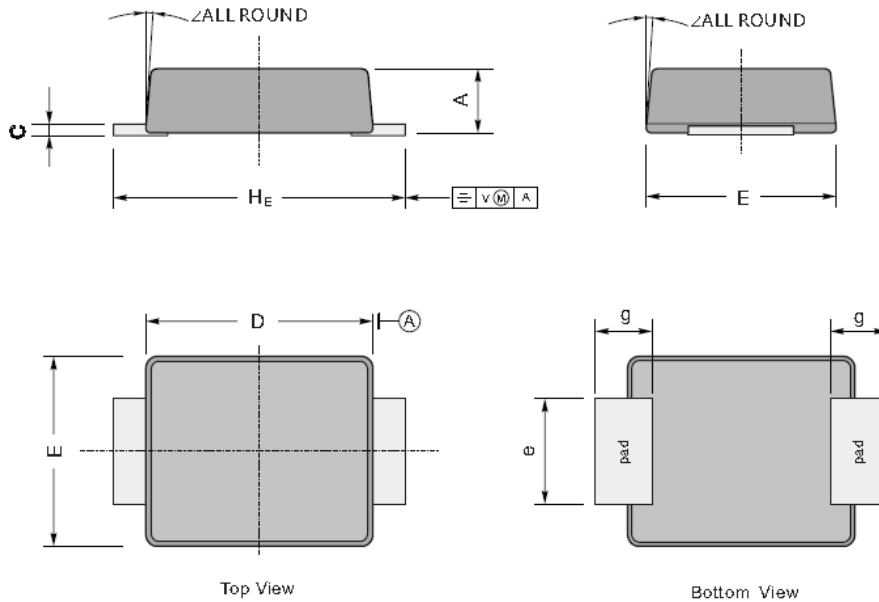

| UNIT | | A | C | D | E | H _E | e | g | ∠ |
|------|-----|-----|------|-----|-----|----------------|-----|-----|----|
| mm | max | 1.3 | 0.26 | 4.4 | 3.7 | 5.5 | 2.2 | 1.0 | 9° |
| | min | 1.1 | 0.18 | 4.2 | 3.5 | 5.1 | 1.9 | | |
| mil | max | 51 | 10 | 173 | 146 | 216 | 86 | 40 | |
| | min | 43 | 7 | 165 | 138 | 200 | 75 | | |

The recommended mounting pad size

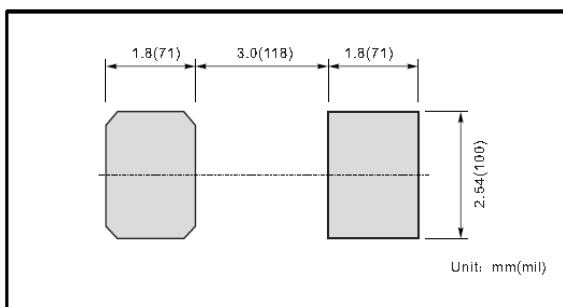

Marking

| Type number | Marking code |
|-------------|--------------|
| SS32BF | S32B |
| SS34BF | S34B |
| SS36BF | S36B |
| SS38BF | S38B |
| SS310BF | S310B |
| SS312BF | S312B |
| SS515BF | S315B |
| SS520BF | S320B |

SHIKE MAKE CONSCIOUS PRODUCT

CONSCIOUS PRODUCTS BEGIN WITH CONSCIOUS PEOPLE

REV.07



www.shike.tw