

RS1608 Series 16A TRIACs

DESCRIPTION :

High current density due to double mesa technology, SIPOS and Glass Passivation.

RS1608A/B series triacs is suitable for general purpose AC switching, They can be used as an ON/OFF function in applications such as static relays, heating regulation, induction motor starting circuits...or for phase control operation, light dimmers, motor speed controllers.

RS1608A/B-SW -CW -BW are 3 quadrants triacs, They are specially recommended for use on inductive loads.

RS1608A are isolated in internal, they provide a 2500V RMS isolation voltage from all three terminals to external heat sink.

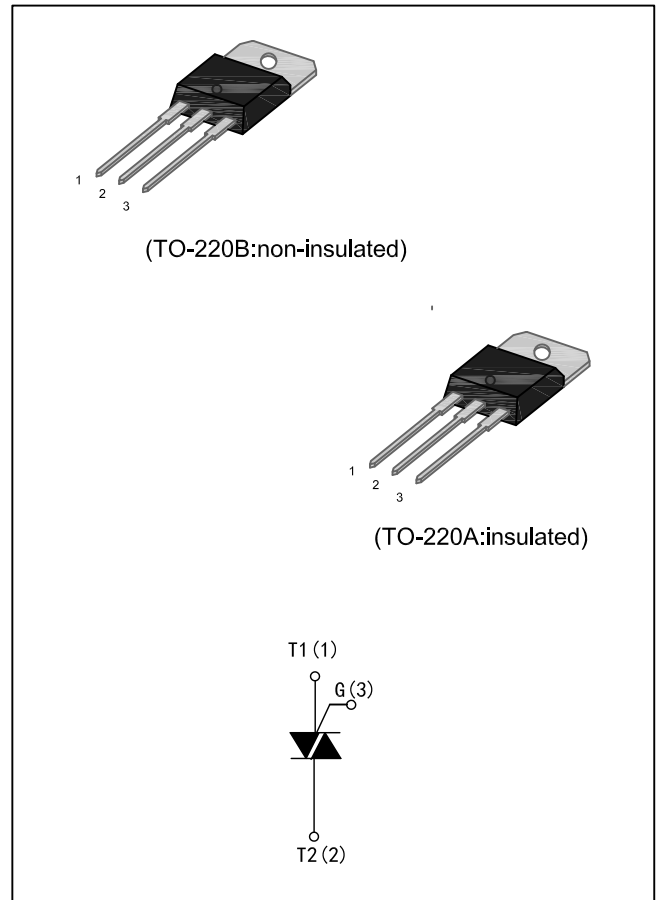

MAIN FEATURES

Symbol	Value	Unit
$I_T(\text{RMS})$	16	A
$V_{\text{DRM}}/V_{\text{RRM}}$	600 and 800	V
V_{TM}	1.55	V

ABSOLUTE MAXIMUM RATINGS

Parameter	Symbol	Value	Unit
Storage junction temperature range	T_{stg}	-40 to +150	°C
Operating junction temperature range	T_j	-40 to +125	°C
Repetitive Peak Off-state Voltage	$T_j=25^\circ\text{C}$	V_{DRM}	600and800
Repetitive Peak Reverse Voltage	$T_j=25^\circ\text{C}$	V_{RRM}	600and800
Non repetitive Surge Peak Off-state Voltage	$t_p=10\text{ms}, T_j=25^\circ\text{C}$	V_{DSM}	700and900
Non repetitive Peak Reverse Voltage		V_{RSM}	700and900
RMS on-state current (full sine wave)	RS1608B $T_c=100^\circ\text{C}$	$I_T(\text{RMS})$	16
	RS1608A $T_c=86^\circ\text{C}$		
Non repetitive surge peak on-state current (full cycle, $T_j=25^\circ\text{C}$)	$f = 60 \text{ Hz}$ $t = 16.7\text{ms}$	I_{TSM}	168
	$f = 50 \text{ Hz}$ $t = 20\text{ms}$		160
I^2t Value for fusing	$t_p=10\text{ms}$	I^2t	144
Critical rate of rise of on-state current ($I_G=2 \times I_{GT}, t_r \leq 100 \text{ ns}, f=120\text{Hz}, T_j=125^\circ\text{C}$)	di/dt	50	A/ μs
Peak gate current ($t_p=20\mu\text{s}, T_j=125^\circ\text{C}$)	I_{GM}	4	A
Peak Gate Power Dissipation ($t_p=20\mu\text{s}, T_j=125^\circ\text{C}$)	P_{GM}	10	W
Average gate power dissipation ($T_j=125^\circ\text{C}$)	$P_{G(AV)}$	1	W

ELECTRICAL CHARACTERISTICS (T_j=25°C unless otherwise specified)

● 3 Quadrants

Symbol	Test Condition	Quadrant		RS1608				Unit
				TW	SW	CW	BW	
I _{GT}	V _D =12V R _L =33Ω	I-II-III	MAX.	5	10	35	50	mA
V _{GT}		I-II-III	MAX.	1.3				V
V _{GD}	V _D =V _{DRM} R _L =3.3KΩ T _j =125°C	I-II-III	MIN.	0.2				V
I _L	I _G =1.2I _{GT}	I-III	MAX.	15	20	50	70	mA
		II	MAX.	25	35	60	80	mA
I _H	I _T =500mA		MAX.	10	15	40	60	mA
dV/dt	V _D =67%V _{DRM} gate open T _j =125°C		MIN.	20	40	400	1000	V/μs
(dI/dt) _c	(dV/dt) _c =0.1V/μs T _j =125°C		MIN.	3.5	8.5	---	---	A/ms
	(dV/dt) _c =10V/μs T _j =125°C			1.0	3.0	---	---	
	Without snubber T _j =125°C			---	---	8.5	14	

● 4 Quadrants

Symbol	Test Condition	Quadrant		RS1608		Unit
				C	B	
I _{GT}	V _D =12V R _L =33Ω	I-II-III IV	MAX.	25 50	50 100	mA
V _{GT}		ALL	MAX.	1.3		V
V _{GD}	V _D =V _{DRM} R _L =3.3KΩ T _j =125°C	ALL	MIN.	0.2		V
I _L	I _G =1.2I _{GT}	I-III-IV	MAX.	40	50	mA
		II	MAX.	80	100	mA
I _H	I _T =500mA		MAX.	25	50	mA
dV/dt	V _D =67%V _{DRM} gate open T _j =125°C		MIN.	200	400	V/μs
(dV/dt) _c	(dI/dt) _c =7A/ms T _j =125°C		MIN.	5	10	V/μs

STATIC CHARACTERISTICS

Symbol	Parameter		Value(MAX.)	Unit
V _{TM}	I _{TM} =22.5A, t _p =380μs	T _j =25°C	1.55	V
I _{DRM} I _{RRM}	V _D =V _{DRM} V _R =V _{RRM}	T _j =25°C	5	μA
		T _j =150°C	2	mA

THERMAL RESISTANCES

Symbol	Parameter		Value	Unit
R _{th(j-c)}	Junction to Case(AC)	TO-220B	2.1	°C/W
		TO-220A	1.2	
R _{th(j-a)}	Junction to ambient (S=1cm ²)	TO-220A	60	°C/W
		TO-220B	60	

ORDERING INFORMATION

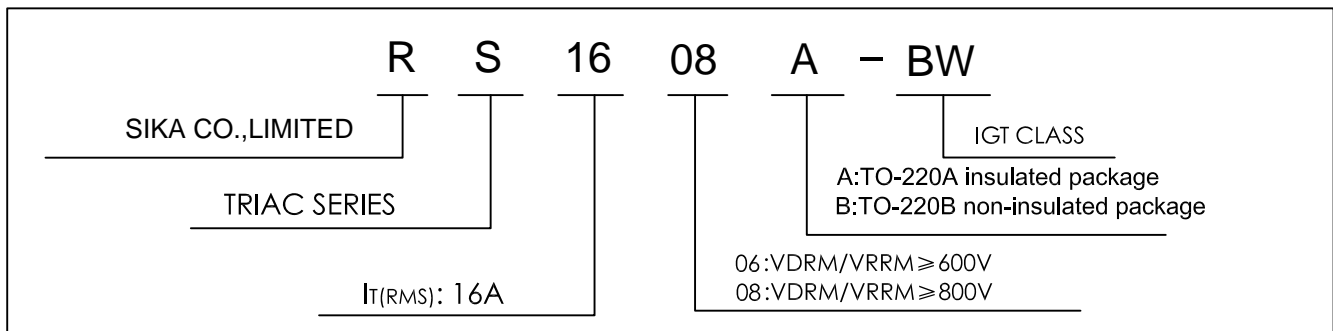

PACKAGE MECHANICAL DATA

TO-220A insulated package and TO-220B non-insulated package

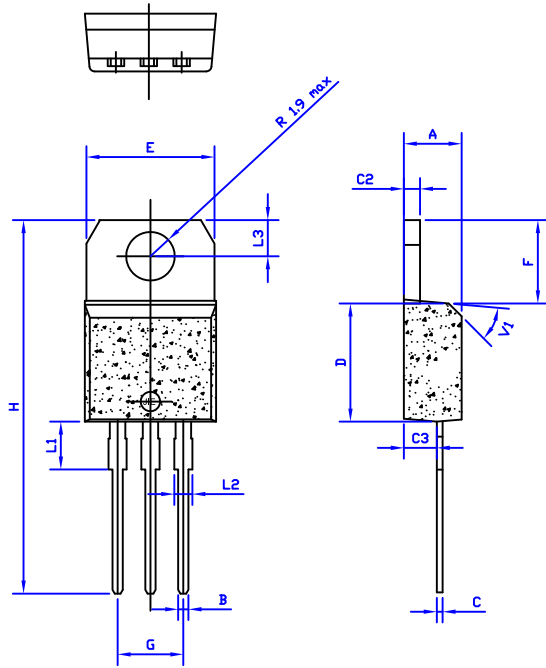

Ref.	Dimensions					
	Millimeters			Inches		
	Min.	Typ.	Max.	Min.	Typ.	Max.
A	4.4		4.6	0.173		1.181
B	0.61		0.88	0.024		0.034
C	0.46		0.70	0.018		0.027
C2	1.23		1.32	0.048		0.051
C3	2.4		2.72	0.094		0.107
D	8.6		9.7	0.338		0.382
E	9.8		10.4	0.386		0.409
F	6.2		6.6	0.244		0.259
G	4.8		5.4	0.189		0.213
H	28.0		29.8	11.0		11.7
L1		3.75			0.147	
L2	1.14		1.7	0.044		0.066
L3	2.65		2.95	0.104		0.116
V1		40°			40°	

FIG.1: Maximum power dissipation versus RMS on-state current (full cycle)

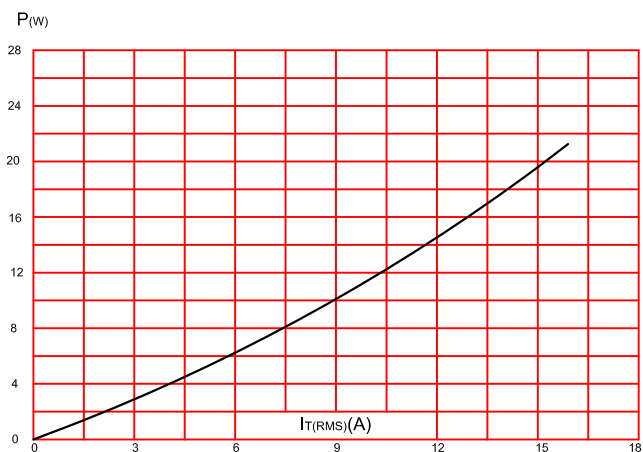

FIG.2: RMS on-state current versus case temperature (full cycle)

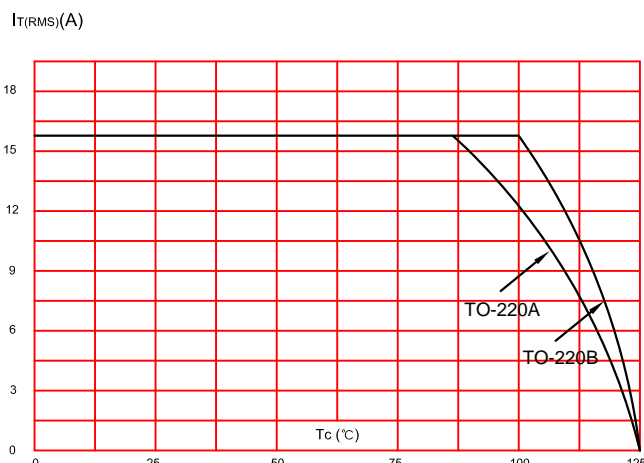

FIG.3: On-state characteristics (maximum values).

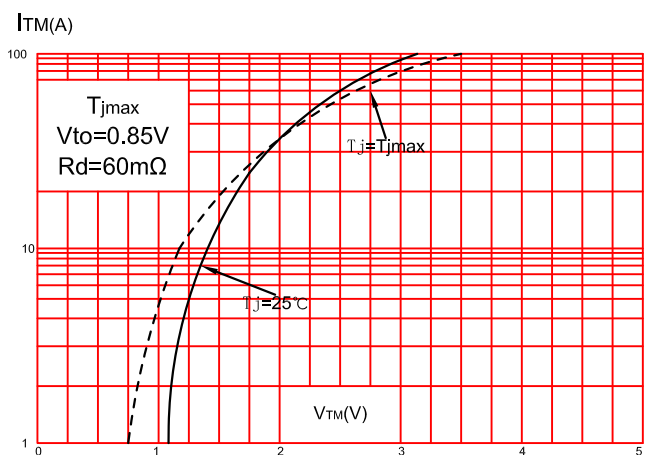

FIG.4: Surge peak on-state current versus number of cycles.

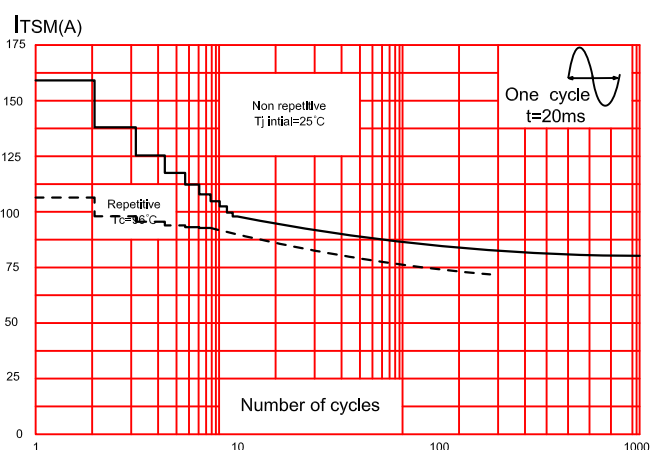

FIG.5: Non-repetitive surge peak on-state current for a sinusoidal pulse with width $t_p < 10\text{ms}$, and corresponding value of I^2t .

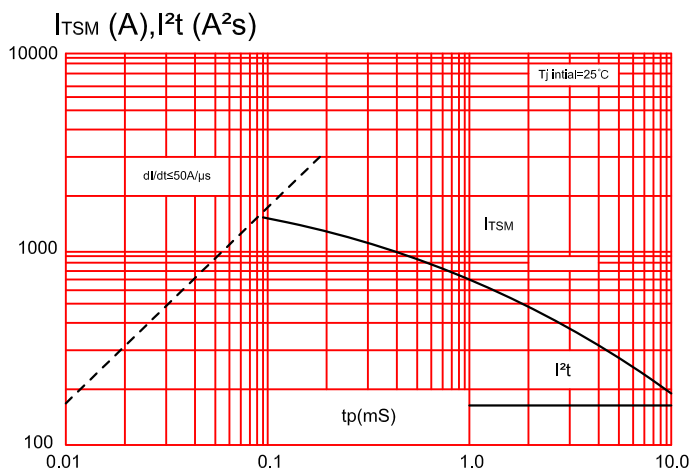

FIG.6: Relative variations of gate trigger current, holding current and latching current versus junction temperature (typical values)

