



**Surface Mount Ultrafast Recovery Rectifier**

**Reverse Voltage – 50V~1000 V**

**Forward Current – 3.0 A**

**FEATURES**

- For surface mounted applications
- Low profile package
- Glass Passivated Chip Junction
- Easy to pick and place
- High efficiency
- Lead free in comply with EU RoHS 2011/65/EU directives

**MECHANICAL DATA**

- Case: SMBF
- Terminals: Solderable per MIL-STD-750, Method 2026
- Approx. Weight: 57mg / 0.002oz

**PINNING**

PIN	DESCRIPTION
1	Cathode
2	Anode

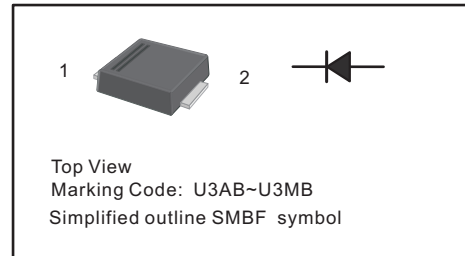

**Maximum Ratings and Electrical characteristics**

Ratings at 25 °C ambient temperature unless otherwise specified.

Single phase half-wave 60 Hz, resistive or inductive load, for capacitive load current derate by 20 %.

Parameter	Symbols	US3ABF	US3BBF	US3DBF	US3GBF	US3JBF	US3KBF	US3MBF	Units
Maximum Repetitive Peak Reverse Voltage	$V_{RRM}$	50	100	200	400	600	800	1000	V
Maximum RMS voltage	$V_{RMS}$	35	70	140	280	420	560	700	V
Maximum DC Blocking Voltage	$V_{DC}$	50	100	200	400	600	800	1000	V
Maximum Average Forward Rectified Current at $T_c = 125\text{ }^\circ\text{C}$	$I_{F(AV)}$	3							A
Peak Forward Surge Current 8.3 ms Single Half Sine Wave Superimposed on Rated Load	$I_{FSM}$	80							A
Maximum Instantaneous Forward Voltage at 3 A	$V_F$	1.0		1.3		1.68			V
Maximum DC Reverse Current $T_a = 25\text{ }^\circ\text{C}$ at Rated DC Blocking Voltage $T_a = 125\text{ }^\circ\text{C}$	$I_R$	5 100							$\mu\text{A}$
Maximum Reverse Recovery Time <sup>(1)</sup>	$t_{rr}$	50				75			ns
Typical Thermal Resistance <sup>(2)</sup>	$R_{\theta JA}$ $R_{\theta JC}$	45 15							$^\circ\text{C/W}$
Operating and Storage Temperature Range	$T_j, T_{stg}$	-55 ~ +150							$^\circ\text{C}$

( 1 ) Measured with  $I_F = 0.5\text{ A}$ ,  $I_R = 1\text{ A}$ ,  $I_{rr} = 0.25\text{ A}$ .

( 2 ) P.C.B. mounted with 2.0" X 2.0" (5 X 5 cm) copper pad areas.



Fig.1 Maximum Average Forward Current Rating

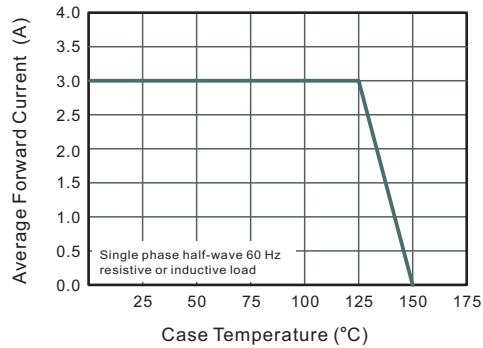

Fig.2 Typical Reverse Characteristics

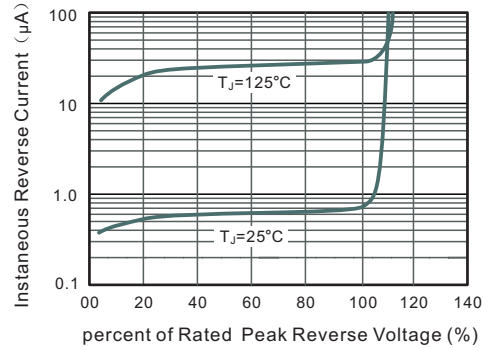

Fig.3 Typical Forward Characteristics

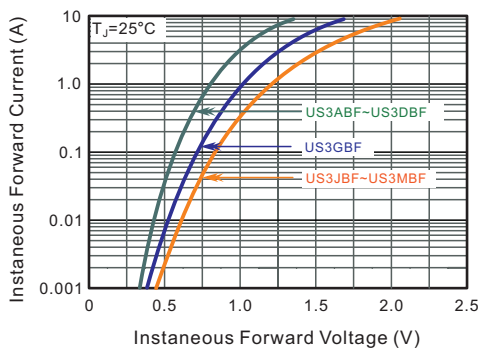
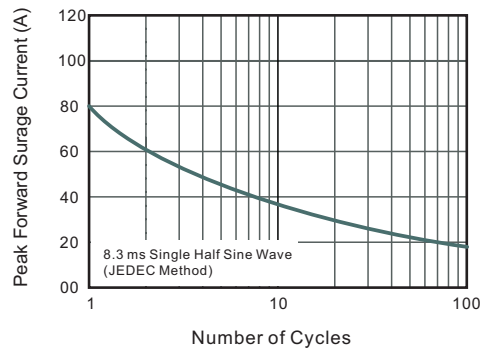

Fig.4 Maximum Non-Repetitive Peak Forward Surge Current





PACKAGE OUTLINE

Plastic surface mounted package; 2 leads

SMBF

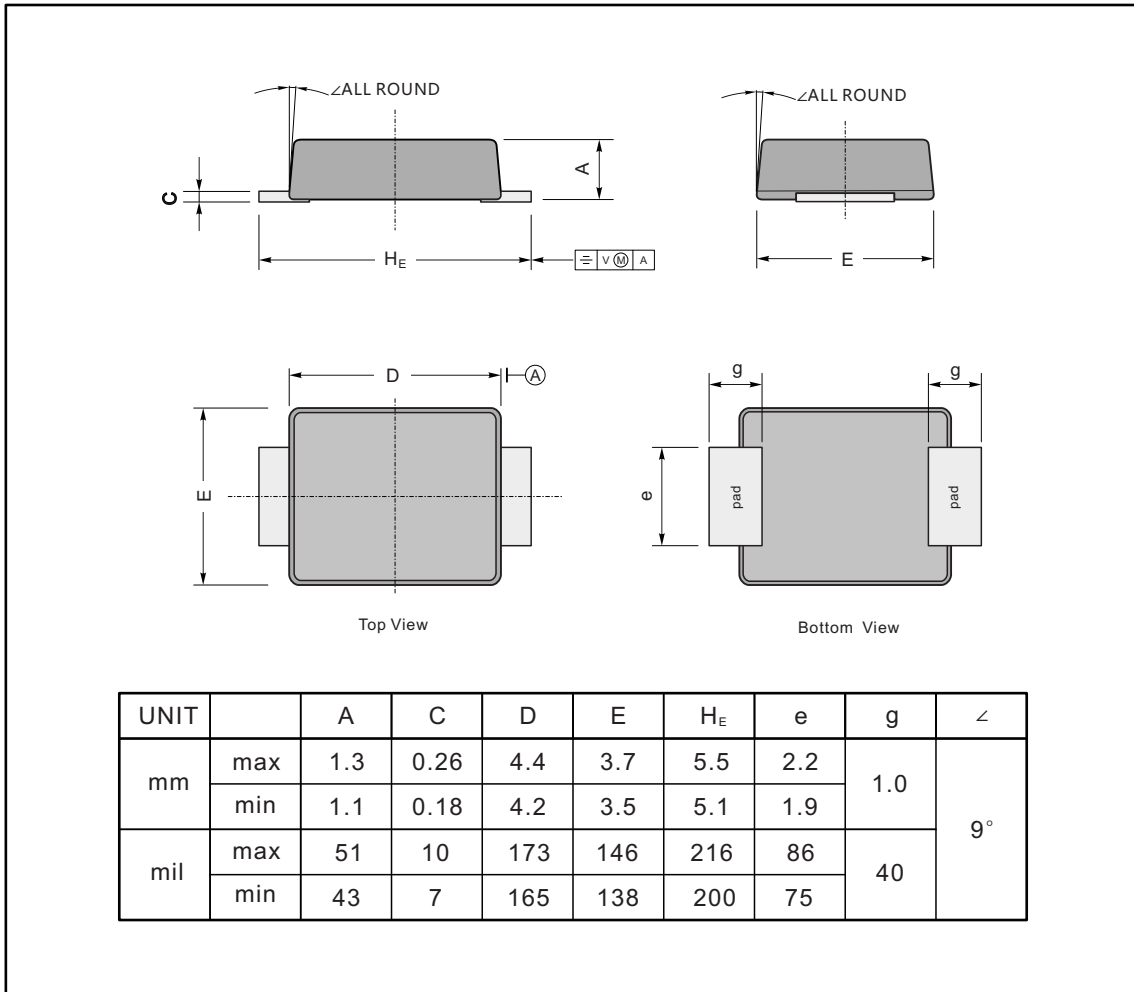

The recommended mounting pad size

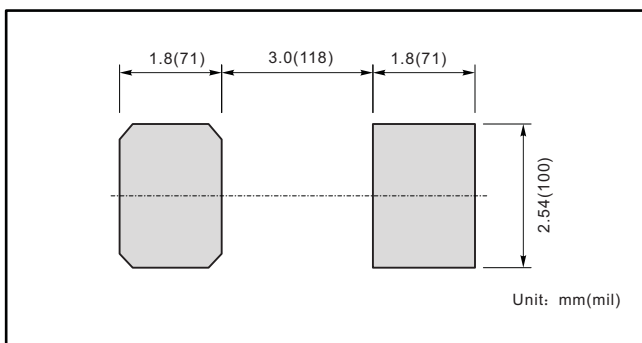

Marking

Type number	Marking code
US3ABF	U3AB
US3BBF	U3BB
US3DBF	U3DB
US3GBF	U3GB
US3JBF	U3JB
US3KBF	U3KB
US3MBF	U3MB