



GLASS PASSIVATED BRIDGE RECTIFIERS

REVERSE VOLTAGE - 50 to 1000 Volts
FORWARD CURRENT - 4.0 Amperes

FEATURES

- Rating to 1000V PRV
- Ideal for printed circuit board
- Reliable low cost construction utilizing molded plastic technique
- The plastic material has UL flammability classification 94V#0

MECHANICAL DATA

- Polarity : As marked on body
- Weight : 0.05 ounces, 1.52 grams
- Mounting position : Any

KBP

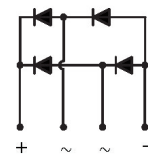
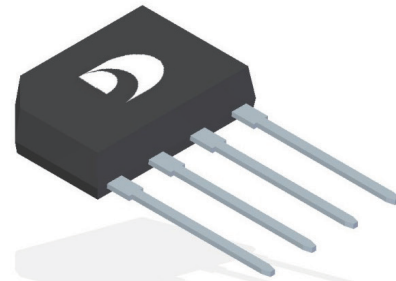

MAXIMUM RATINGS AND ELECTRICAL CHARACTERISTICS

Ratings at 25°C ambient temperature unless otherwise specified.

CHARACTERISTICS	SYMBOL	KBP 4005G	KBP 401G	KBP 402G	KBP 404G	KBP 406G	KBP 408G	KBP 410G	UNIT	
Maximum Repetitive Peak Reverse Voltage	V_{RRM}	50	100	200	400	600	800	1000	V	
Maximum RMS Voltage	V_{RMS}	35	70	140	280	420	560	700	V	
Maximum DC Blocking Voltage	V_{DC}	50	100	200	400	600	800	1000	V	
Maximum Average Forward Rectified Current @ $T_C=105^\circ\text{C}$	$I_{(AV)}$					4.0 2.0				A
Peak Forward Surge Current @ $T_J = 25^\circ\text{C}$	I_{FSM}					130				A
8.3ms single half sine-wave @ $T_J = 125^\circ\text{C}$						110				
Peak Forward Surge Current @ $T_J = 25^\circ\text{C}$	I_{FSM}					260				A
1.0ms single half sine-wave @ $T_J = 125^\circ\text{C}$						220				
Maximum Forward Voltage at 4.0A DC	V_F					1.1				V
Maximum DC Reverse Current at rated Blocking Voltage @ $T_J=25^\circ\text{C}$ @ $T_J=125^\circ\text{C}$	I_R					5.0 500				μA
I^2t Rating for fusing ($3\text{ms} \leq t \leq 8.3\text{ms}$)	I^2t					50				A^2S
Typical Junction Capacitance per element (Note 1)	C_J					40				pF
Typical thermal resistance (Unit mounted on 75mmx75mmx1.6mm Copper plate heatsink.)	$R_{\theta JC}$ $R_{\theta JL}$ $R_{\theta JA}$					6 8 15				$^\circ\text{C/W}$
Typical thermal resistance (without heatsink)	$R_{\theta JC}$ $R_{\theta JL}$ $R_{\theta JA}$					14 20 40				$^\circ\text{C/W}$
Operation and Storage Temperature Range	T_J, T_{STG}					-55 to 150				$^\circ\text{C}$

Note : (1) Measured at 1.0MHz and applied reverse voltage of 4.0V DC.



FIG.1- FORWARD CURRENT DERATING CURVE

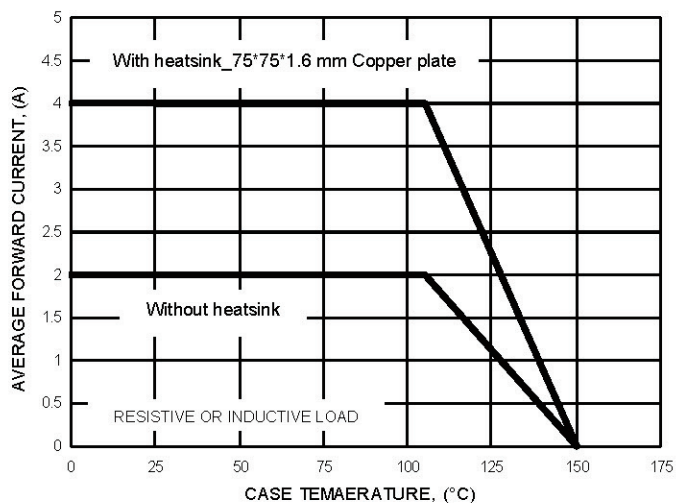

FIG.2- MAXIMUM NON-REPETITIVE SURGE CURRENT

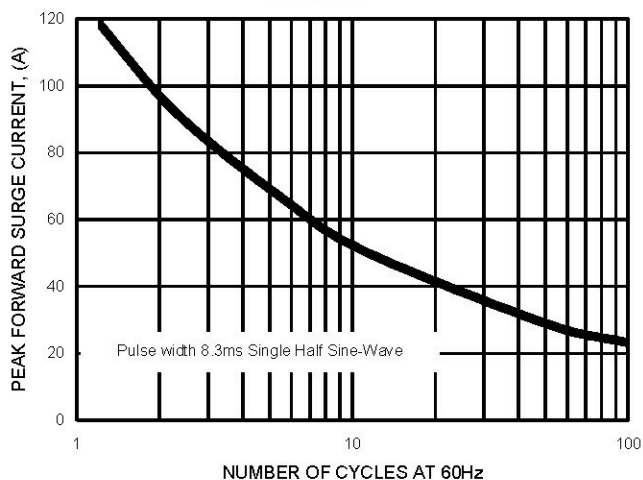

FIG.3- TYPICAL JUNCTION CAPACITANCE

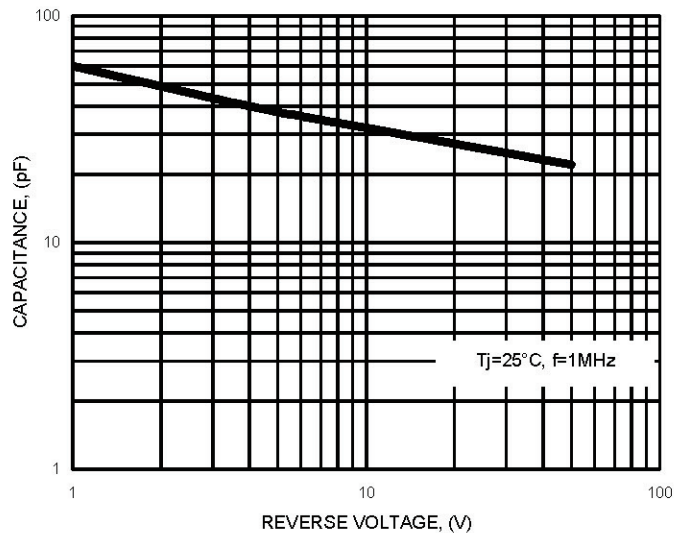

FIG.4- TYPICAL FORWARD CHARACTERISTICS

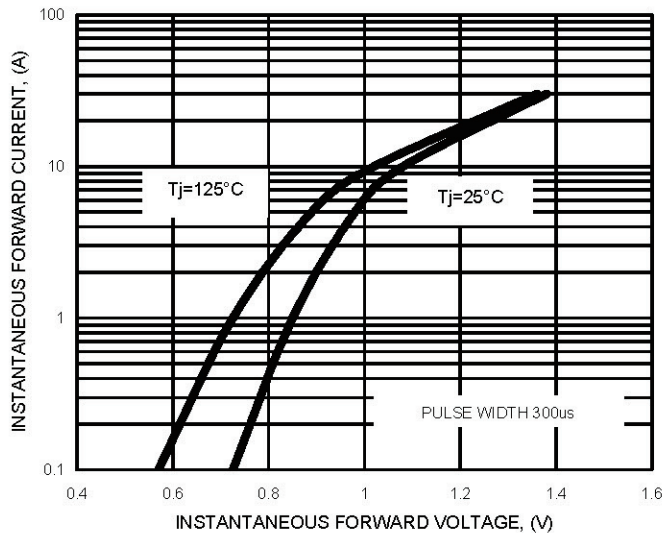
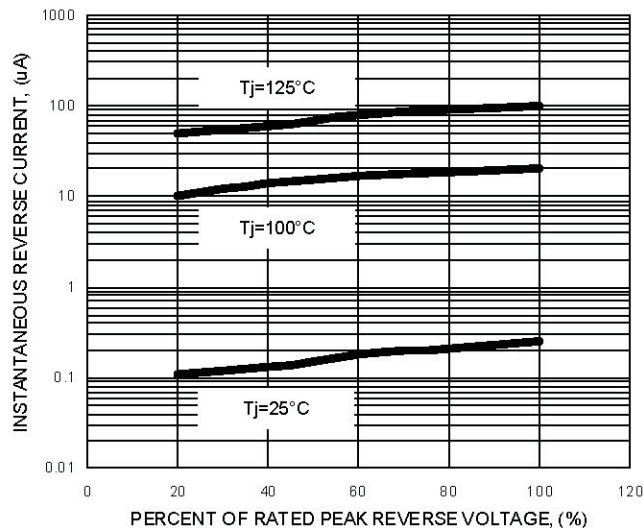
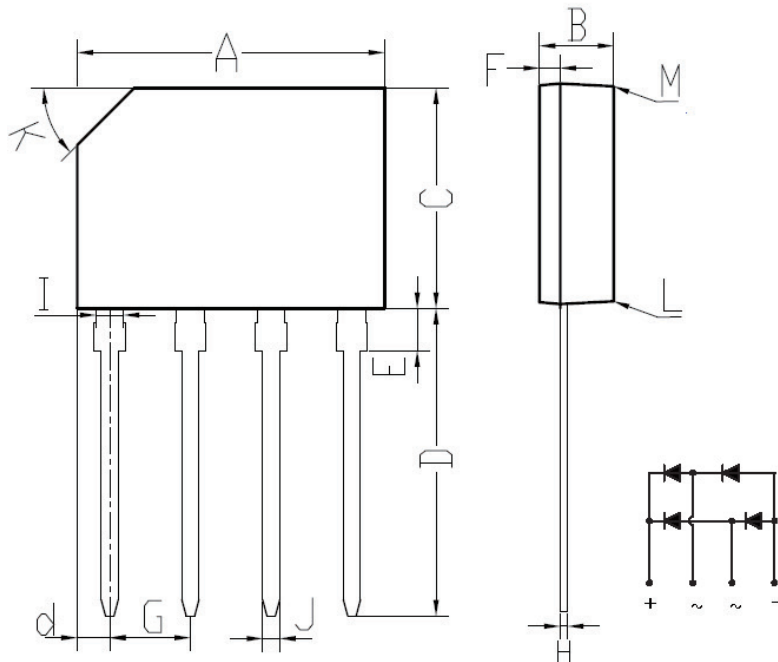

FIG.5- TYPICAL REVERSE CHARACTERISTICS





KBP Package Outline Dimensions



KBP		
DIM.	MIN.	MAX.
A	14.25	14.75
B	3.35	3.65
C	10.20	10.60
D	14.25	14.73
d	1.40	1.70
E	1.80	2.20
F	0.80	1.10
G	3.56	4.06
H	0.35	0.55
I	1.22	1.42
J	0.76	0.86
K	2.7 x 45° (Typ)	
L	#	3°
M	#	2°
All Dimensions in millimeter		