



PMP SERIES

PROPORTIONAL CONTROL SOLID STATE RELAYS

Introduction

The PMP Series of micro-controller based Single-Phase Proportional Control SSRs are designed to offer precise control of the power delivered to a resistive load in a compact 22.5mm housing, with ratings from 25 up to 90 Amps at 90 to 600 VAC. PMP Series solid state relays can vary the output load power proportionally to an analog control input from 0 to 100%. This can be achieved by two different methods: Phase Angle control and Burst Fire control (with Distributive Zero Cross). The control method to be used can be selected on the unit by means of a selector switch located on top of the SSR. This selector switch also allows to select the type of analog signal to be used at the control input. The available input types are: 0- 5 VDC, 0-10 VDC, and 4-20 mA. PMP Series Proportional SSRs are ideal for lamp dimming and resistive heating control, among other type of applications requiring proportional control.



Features

- Single Phase Proportional Controller
- Output ratings up to 90 Amps at 600 VAC
- Selectable operation mode: Phase Angle or Burst Fire control
- Selectable Control Input: 0-5 VDC, 0-10 VDC, 4-20 mA
- 50/60 Hz Adaptive Operational Frequency function
- 4-20 mA input does not require an auxiliary power supply
- LED multifunction status indicator
- Contactor configuration with "Elevator" screw terminals
- cURus, IEC Rated, CE & RoHS Compliant



PRODUCT SELECTION

Operating Voltage	25 A	50 A	90 A
90-280 VAC	PMP2425W	PMP2450W	PMP2490W
345-530 VAC	PMP4825W	PMP4850W	PMP4890W
420-600 VAC	PMP6025W	PMP6050W	PMP6090W



SPECIFICATIONS

Output Voltage ⁽²⁾

Description	PMP24xxW	PMP48xxW	PMP60xxW
Operating Voltage (45-65Hz) [Vrms]	90-280	345-530	420-600
Transient Overvoltage [Vpk] ¹	600	1200	1200
Maximum Off-State Leakage Current @ Rated Voltage [mArms]	4	2.2	2
Minimum Off-State dV/dt @ Maximum Rated Voltage [V/μsec]	500	500	500

Output ⁽²⁾

Description	25 A	50 A	90 A
Load Current, General Use UL508 @ 40°C [ARMS] ³	25	50	90
Minimum Load Current [mArms] ⁴	100	100	150
Maximum 1 Cycle Surge Current (50/60Hz) [Apk]	286/300	716/750	1290/1350
Maximum On-State Voltage Drop @ Rated Current [Vrms]	1.15	1.15	1.2
Maximum 1/2 Cycle I ² t for Fusing (50/60Hz) [A ² sec]	409/375	2563/2343	8320/7593
Thermal Resistance Junction to Case (Rjc) [°C/W]	0.49	0.27	0.2
Maximum Power Dissipation @ Rated Current [W]	29	58	104
Recommended Heat Sink for Rated Current @ 40°C [°C/W]	2	1	0.36
Minimum Power Factor (at Maximum load)	0.7	0.7	0.7
Phase Angle Control Range [%]	0 to 100	0 to 100	0 to 100
Burst Fire Distributive Control Time Base Period	0 to 20 Cycles	0 to 20 Cycles	0 to 20 Cycles

Power Supply ^{(2) (5) (6)}

Description	PMP
Supply Voltage Range [VDC]	8-30
Maximum Supply Current [mA]	30
Overvoltage Protection	Limited to 35 VDC for 60 sec
Reverse Polarity Protection	Yes

Input ⁽²⁾

Description	Voltage Control	Current Control
Valid Input Voltage [VDC] / Current [mA]	0-10, 0-5	4-20
Maximum Allowed Input Voltage [VDC] / Current [mA]	30	35
Maximum Reverse Voltage [VDC] / Current [mA]	-30	-35
Pick up Voltage [VDC] / Current [mA]	0.4	4.3
Dropout Voltage [VDC] / Current [mA]	0.1	4
Nominal Input Impedance [Ohms]	28.8k	230 @ 20 mA
Maximum Initialization Time [msec]	5 Cycles	5 Cycles
Response Time	1 Cycle	1 Cycle

General ⁽²⁾

Description	Parameters
Dielectric Strength, Input to Output (50/60Hz)	4000 Vrms
Dielectric Strength, Input/Output to Baseplate (50/60Hz)	4000 Vrms
Minimum Insulation Resistance (@ 500 VDC)	10 ⁹ Ohms
Maximum Capacitance, Input/Output	8 pF
Ambient Operating Temperature Range ⁷	-25 to 70 °C
Ambient Storage Temperature Range ⁷	-25 to 70 °C
Weight (typical)	2.6 oz (73 g)
Housing Material	UL94 V-0
Baseplate Material	Aluminum
Hardware Finish	Nickel Plating
SSR Mounting Screw Torque Range (lb-in/Nm)	20-25/2.2-2.8
Humidity per IEC 60068-2-78	93% non-condensing
LED Input Status Indicator	See Status Chart
Overvoltage Category	III
Impulse Withstand Voltage According to IEC 60664-1	6 kV
Adaptive Operational Frequency Function	Yes

SURGE CURRENT INFORMATION

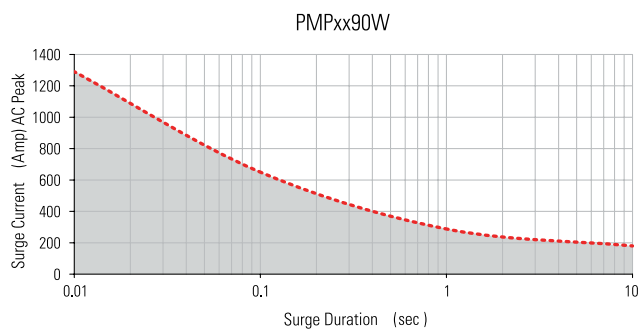
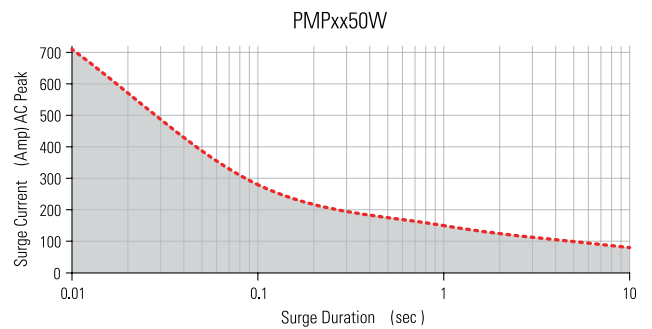
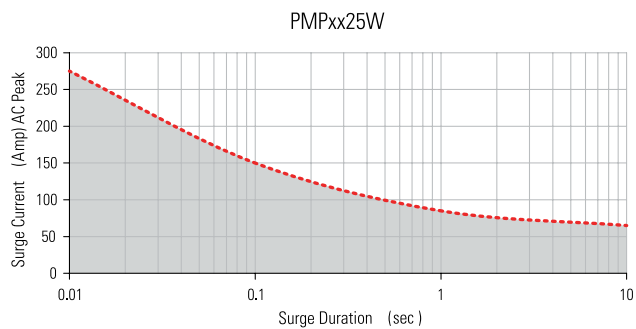

--- Single Pulse (8)



POWER DISSIPATION

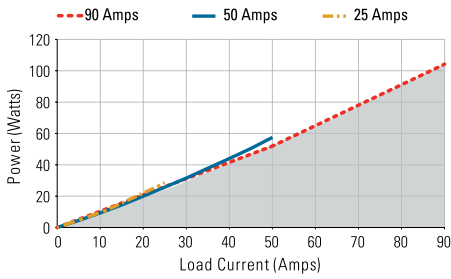

THERMAL DERATE INFORMATION ⁹

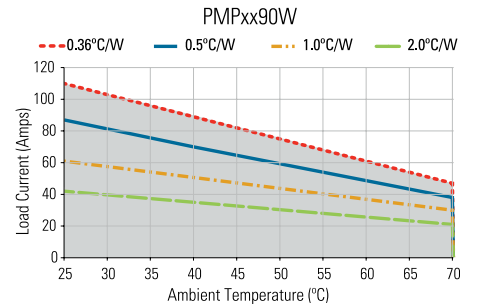
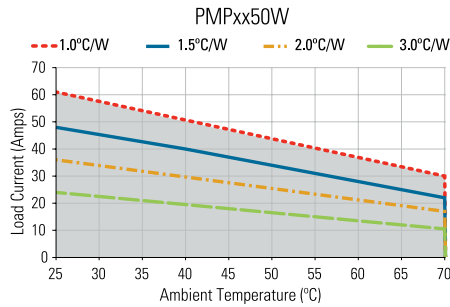
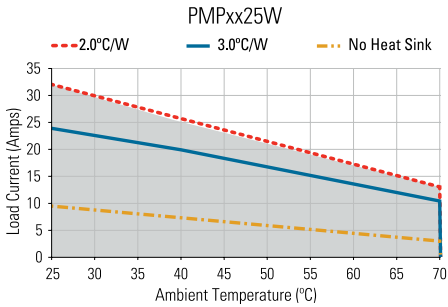

TRANSFER CHARACTERISTICS

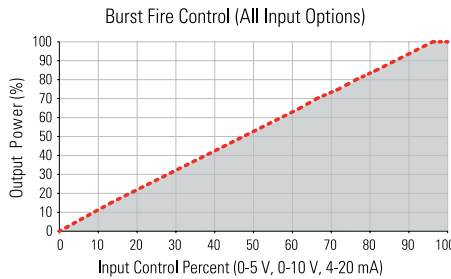
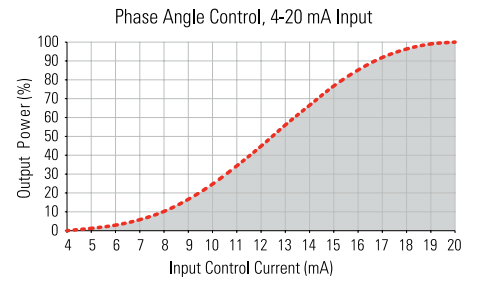
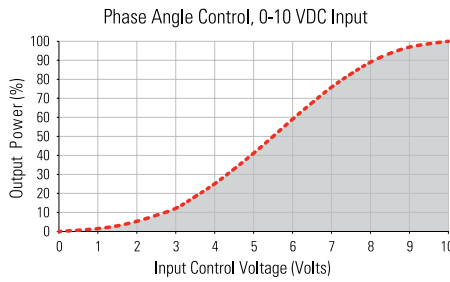
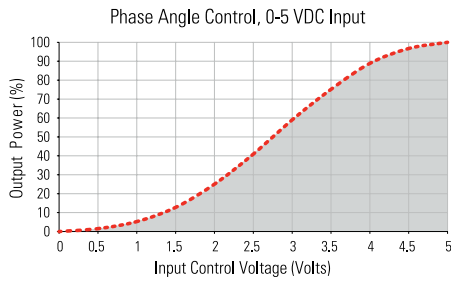

INPUT CURRENT VS INPUT VOLTAGE

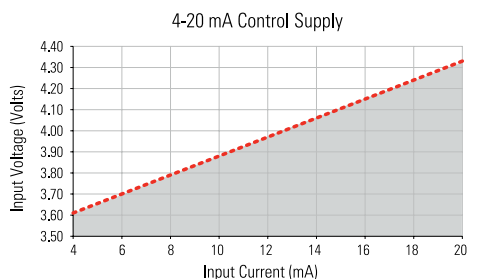
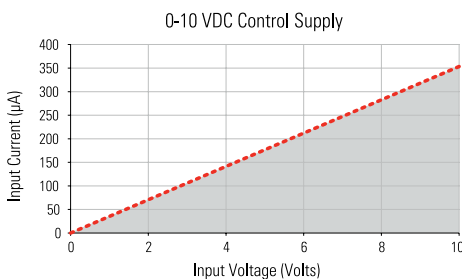
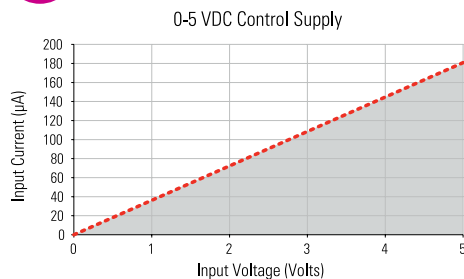



EQUIVALENT CIRCUIT BLOCK DIAGRAM/WIRING DIAGRAM

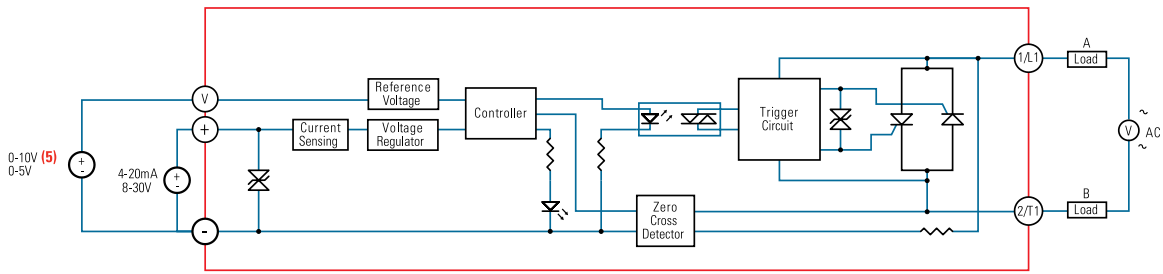

INSTALLATION INSTRUCTIONS

Mounting on Heat Sink

- Select adequate heat sink (see thermal derating curves).
- Be sure to use a thermal pad or thermal compound (0.006-0.008 in layer thickness recommended) SSR and the selected heat sink.
- SSR housing mounting holes have a diameter of 0.341in (8.66mm). Two screws are needed to mount the SSR onto a heat sink (See Fig 1). Mounting screws are sold separately as HK8 and are suitable for all Crydom heat sinks. Otherwise, recommended screw size is 8-32 (socket) using an allen wrench (9/64 in) for the installation. Choose screw length considering mounting surface hole depth and SSR baseplate thickness of 0.125 in (3.2 mm).
- Before applying full torque tighten down both screws until they contact the baseplate. Then, tighten them to 20 in-lb (2.2 Nm) min.
- For optimal thermal performance heat sink fins should be oriented vertically to promote natural convection airflow.

Mounting on Panel

- Locate the panel section on which the SSR will be mounted. Panel mount surface must provide adequate heat sinking capability, uncoated, clean, flat (0.004 in/in recommended) and preferably aluminum.
- Be sure to use a thermal pad or thermal compound (0.006-0.008 in layer thickness recommended) between the SSR and the panel.
- SSR housing mounting slots have a diameter of 0.341 in (8.66 mm). Two screws are needed (not included) to mount the SSR onto a panel. Mounting screws are sold separately as HK8. Otherwise, recommended screw size is 8-32 (socket) using allen wrench (9/64 in) for the installation. Choose screw length considering the mounting surface and that the SSR baseplate thickness is 0.125 in (3.2 mm).
- Before applying full torque tighten down both screws until they contact the baseplate. Then, tighten them to 20 in-lb (2.2 Nm) min.

Wire input and output as shown in the Wiring Diagram. For recommended wire sizes and terminal torques see TABLE 1

Select operation mode using the parameter selector switch See TABLE 2

TABLE 1. Recommended Torque and Wire Sizes

Terminal	Max. Screw Torque [lb-in (Nm)]	Wire Size (Solid / Stranded)	Wire Pull-Out Strength (lb)[N]
Output	18-20 (2.0-2.2)	2 x 20 AWG (0.75 mm ²) [minimum]	25 [111]
		2 x 10 AWG (6 mm ²)	80 [355]
		2 x 8 AWG (10 mm ²) [maximum]	90 [400]
Input	5 (0.5)	28 AWG (0.09 mm ²) [minimum]	2.2 [9.8]
		28 AWG (0.09 mm ²) [minimum]	22 [98]

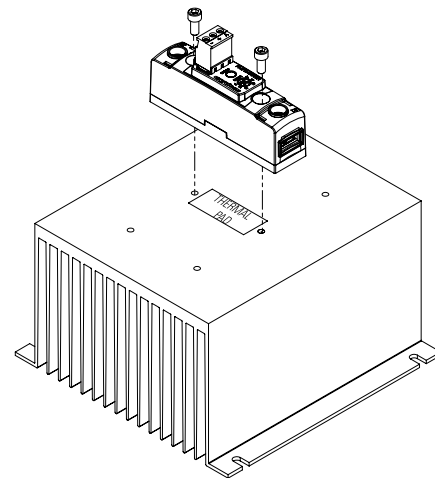
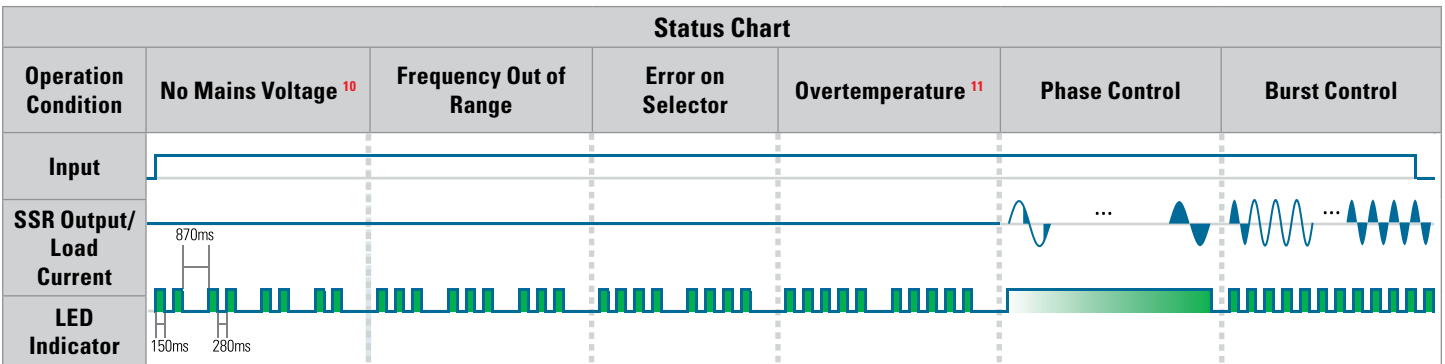

TABLE 2. Operation Mode

Parameter Selector Switch	Mode	Function
	A	Phase Angle, 0-5 VDC control
	B	Phase Angle, 0-10 VDC control
	C	Phase Angle, 4-20 mA control
	D	Burst Fire, 0-5 VDC control
	E	Burst Fire, 0-10 VDC control
	F	Burst Fire, 4-20 mA control

TABLE 3. LED Status

Status	LED Indicator	SSR Output
No Mains Voltage ¹⁰	Flashes twice intermittently	OFF
Frequency Out of Range	Flashes three times intermittently	OFF
Error on Selector	Flashes four times intermittently	OFF
Overtemperature ¹¹	Flashes five times intermittently	OFF
Phase Control	Varying brightness	ON
Burst Control	Varying pulsing rate	ON



Phase Angle Control Operation Mode

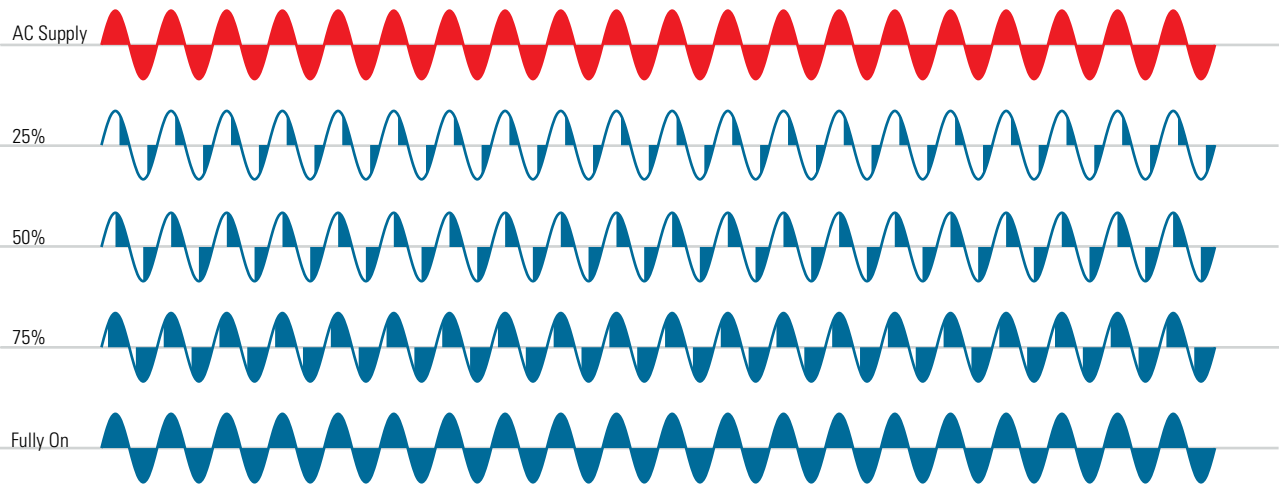

*Blue parts on waveform represent the output on the load

Burst Fire Control Operation Mode

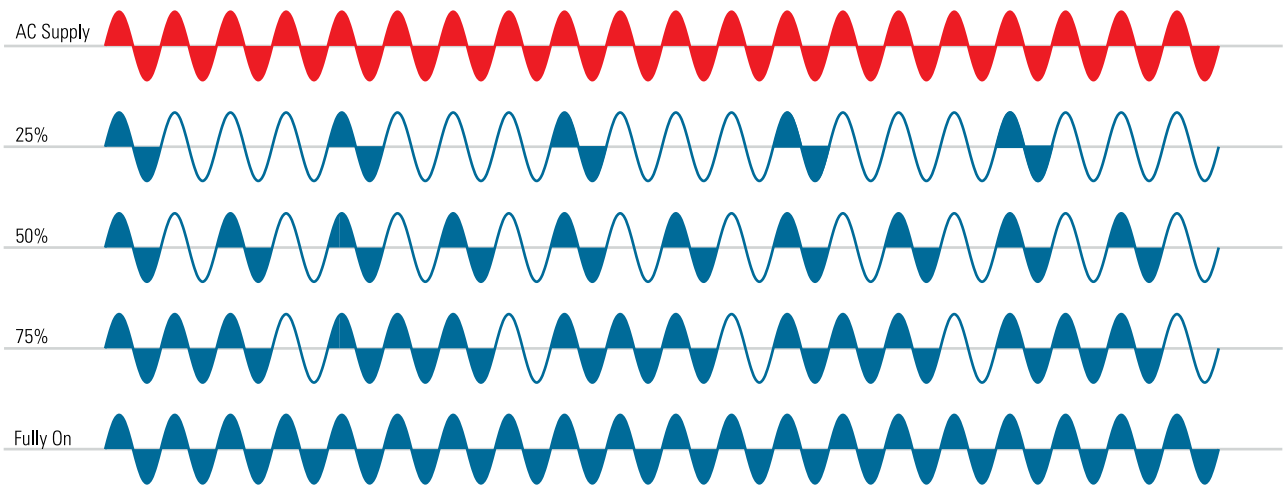

*Blue parts on waveform represent the output on the load



MECHANICAL SPECIFICATIONS

*Tolerances: ± 0.02 in / 0.5 mm All dimensions are in: inches [millimeters]

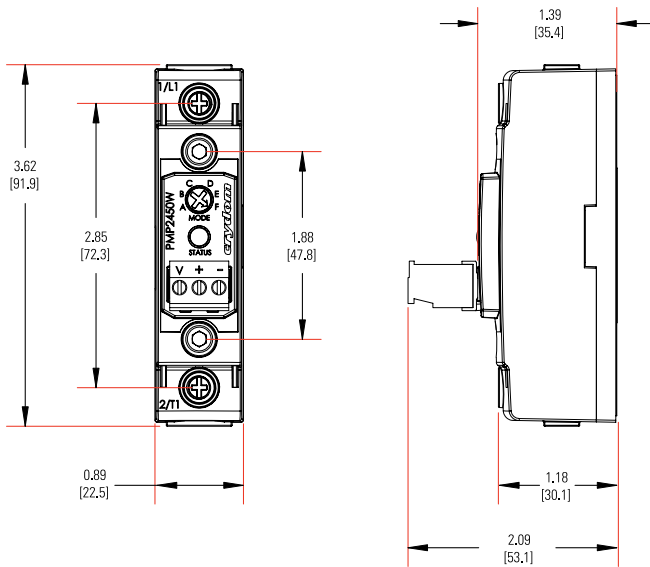



ORDERING OPTIONS

Example : PMP2425WPH

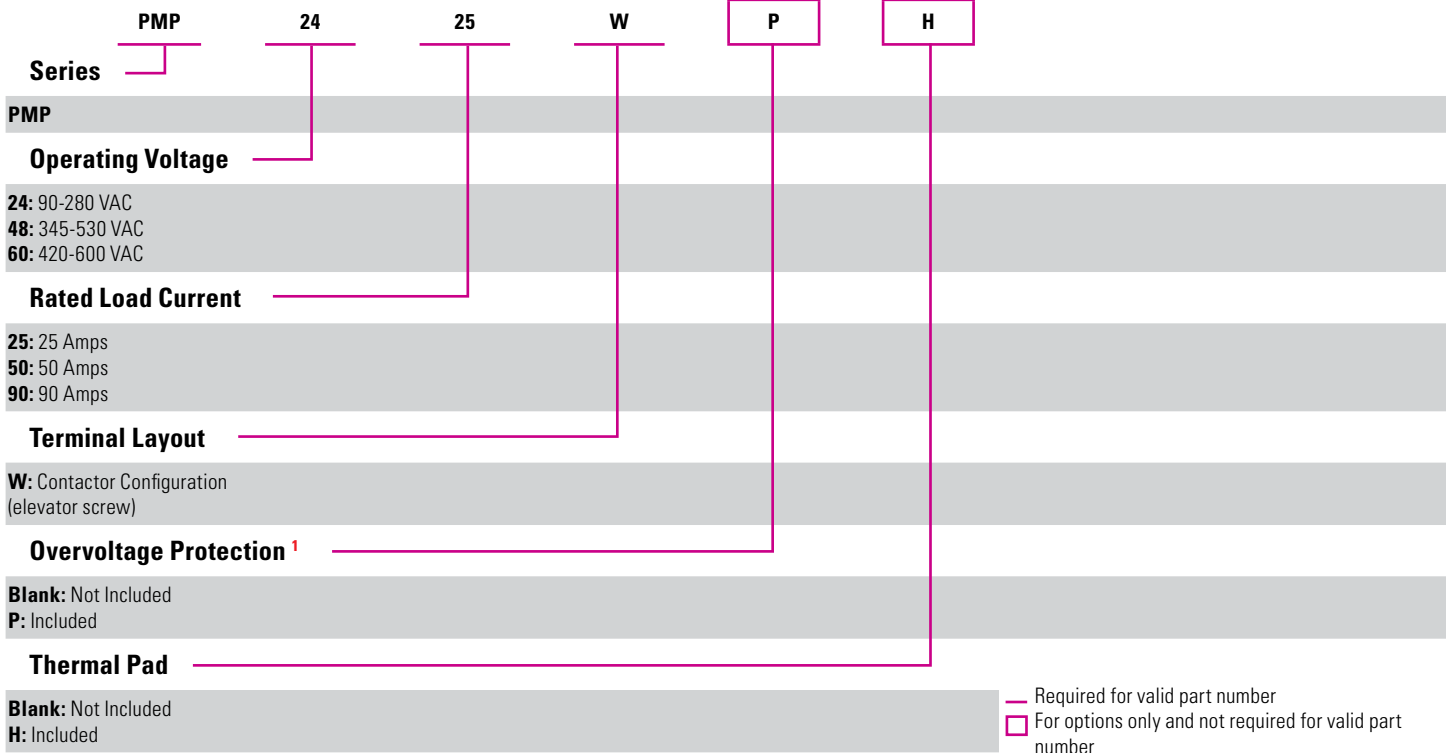

GENERAL NOTES

- (1) "P" option output will self-trigger between 450-600Vpk (for Operating Voltage option 24) or 900-1200Vpk (for Operating Voltage options 48 and 60). Not suitable for capacitive loads.
- (2) All parameters at 25°C unless otherwise specified.
- (3) Heat sinking required, see derating curves. For load currents greater than 50A use conductors with at least 75°C insulation.
- (4) If load current is lower than SSR minimum current, connect resistor in parallel to the load to increase current.
- (5) Not required for Current control.
- (6) Input should be supplied by Class 2 or double insulated power supply.
- (7) No freezing or condensation allowed.
- (8) For single surge pulse Tc=25°C; Tj=125°C. For AC Output SSRs, AC RMS value of surge current equals the peak value divided by 2 (1.414).
- (9) UL approved rating is the one that intersects at 40°C.
- (9) This function is disabled when control signal is set at 100%.
- (10) This condition can be caused by excessive ambient temperature, an incorrect heat sink or high input voltage. The condition will be cleared once the internal temperature cools down below 80 °C.



ACCESSORIES

Recommended Accessories				
 Hardware Kit	 Heat Sink Part No.		 Lug Terminal	 Thermal Pad
	Thermal Resistance [°C/W]			
HK8	HS259DR	2.5	TRM0	HSP-7
	HS073	0.7	TRM6	
	HS072	0.7		
	HS053	0.5		
	HS033	0.36		
	HS023	0.25		

AGENCY APPROVALS & CERTIFICATIONS

Conformances

United States Standard for Industrial Control Equipment - UL 508 and Canadian Standard Association for Industrial Control Equipment – C22.2 No. 14.



Vibration Resistance: IEC 60068-2-6: Amplitude Range 10-500 Hz, Displacement 0.75mm

Shock Resistance: IEC 60068-2-27: Peak Acceleration 50g, Duration 11ms.

Electromagnetic Compatibility					
Generic Standard	Immunity Tests	Test Specification Level		Performance	
IEC 61000-6-2 Immunity for Industrial Environments	Electrostatic Discharge	8kV air discharge		Criterion A	
	IEC 61000-4-2	6kV contact discharge		Criterion A	
	Fast transients (burst)	Output	2kV, 5kHz, 100kHz		Criterion B
		Input	1kV, 5kHz, 100kHz		Criterion B
	Surge	Output	1kV Line to Earth		Criterion B
			2kV Line to Earth		Criterion B
IEC 61000-4-5	Input Power Option	500 VDC +/-		Criterion A	

WARNINGS



RISK OF MATERIAL DAMAGE AND HOT ENCLOSURE

- The product's side panels may be hot, allow the product to cool before touching
- Follow proper mounting instructions including torque values
- Do not allow liquids or foreign objects to enter this product

Failure to follow these instructions can result in serious injury, or equipment damage.



HAZARD OF ELECTRIC SHOCK, EXPLOSION OR ARC FLASH

- Disconnect all power before installing or working with this equipment
- Verify all connections and replace all covers before turning on power

Failure to follow these instructions will result in death or serious injury.

Sensata Technologies, Inc. ("Sensata") data sheets are solely intended to assist designers ("Buyers") who are developing systems that incorporate Sensata products (also referred to herein as "components"). Buyer understands and agrees that Buyer remains responsible for using its independent analysis, evaluation and judgment in designing Buyer's systems and products. Sensata data sheets have been created using standard laboratory conditions and engineering practices. Sensata has not conducted any testing other than that specifically described in the published documentation for a particular data sheet. Sensata may make corrections, enhancements, improvements and other changes to its data sheets or components without notice.

Buyers are authorized to use Sensata data sheets with the Sensata component(s) identified in each particular data sheet. HOWEVER, NO OTHER LICENSE, EXPRESS OR IMPLIED, BY ESTOPPEL OR OTHERWISE TO ANY OTHER SENSATA INTELLECTUAL PROPERTY RIGHT, AND NO LICENSE TO ANY THIRD PARTY TECHNOLOGY OR INTELLECTUAL PROPERTY RIGHT, IS GRANTED HEREIN. SENSATA DATA SHEETS ARE PROVIDED "AS IS". SENSATA MAKES NO WARRANTIES OR REPRESENTATIONS WITH REGARD TO THE DATA SHEETS OR USE OF THE DATA SHEETS, EXPRESS, IMPLIED OR STATUTORY, INCLUDING ACCURACY OR COMPLETENESS. SENSATA DISCLAIMS ANY WARRANTY OF TITLE AND ANY IMPLIED WARRANTIES OF MERCHANTABILITY, FITNESS FOR A PARTICULAR PURPOSE, QUIET ENJOYMENT, QUIET POSSESSION, AND NON-INFRINGEMENT OF ANY THIRD PARTY INTELLECTUAL PROPERTY RIGHTS WITH REGARD TO SENSATA DATA SHEETS OR USE THEREOF.

All products are sold subject to Sensata's terms and conditions of sale supplied at www.sensata.com SENSATA ASSUMES NO LIABILITY FOR APPLICATIONS ASSISTANCE OR THE DESIGN OF BUYERS' PRODUCTS. BUYER ACKNOWLEDGES AND AGREES THAT IT IS SOLELY RESPONSIBLE FOR COMPLIANCE WITH ALL LEGAL, REGULATORY AND SAFETY-RELATED REQUIREMENTS CONCERNING ITS PRODUCTS, AND ANY USE OF SENSATA COMPONENTS IN ITS APPLICATIONS, NOTWITHSTANDING ANY APPLICATIONS-RELATED INFORMATION OR SUPPORT THAT MAY BE PROVIDED BY SENSATA.

Mailing Address: Sensata Technologies, Inc., 529 Pleasant Street, Attleboro, MA 02703, USA.

CONTACT US

Americas

+1 (877) 502 5500
sales.crydom@sensata.com
Europe, Middle East & Africa
 +44 (1202) 416170
ssr-info.eu@sensata.com

Asia Pacific

sales.isasia@list.sensata.com
 China +86 (21) 2306 1500
 Japan +81 (45) 277 7117
 Korea +82 (31) 601 2004
 India +91 (80) 67920890
 Rest of Asia +886 (2) 27602006
 ext 2808