

Safety Standard Certified Ceramic Capacitors-CE Series (Class Y2) Data Sheet





Feature

- Wide operating voltage range from 100pF to 10000pF
- Operating Temperature: -40°C ~ 125°C
- Storage Temperature: 15°C ~ 35°C
- Fix capacitors Y2 for electromagnetic interference suppression and connection to the supply mains has high dielectric coefficient ceramic dielectric and flame retardant epoxy resin package

Applications

- Can be used for power supply noise suppression circuit in cross connection and bypass. It is a primary and secondary coupling X/Y capacitor used as AC line filter and switching power supply and AC converter

Applicable Standard

Approval		Organization	Safety Standards	Certificate No.
USA Canada		UL CUL	UL60384	E208107
Korea		KTL	K60384-14	SU03031-7001
China		CQC	GB/T 6346.14-2015	CQC07001019906
Germany		VDE	En 60384-14	40025748

Approval		Organization	Safety Standards	Certificate No.
EU		ENEC	En 60384-14	40025748
IEC		IEC-CB	IEC 60384-14	US-21745-UL

Part Number Code

G	08	F	1	E	222	M	N0	B	0	S	0	N	0
---	----	---	---	---	-----	---	----	---	---	---	---	---	---

Rated Voltage
G:Y2

Pitch
E:7.5mm
D:10.0mm

Tolerance
K:±10%
M:±20%

Package
B: Bulk
T: Tape

Inner Management

Core Diameter
08:8mm
14:14mm

Nominal capacitance
101:100pF
222:2200pF
103:10000pF

Environmental Standard
0:RoHS
2:RoHS+Halogen-Free

Temperature Characteristic
B:Y5P
E:Y5U
F:Y5V

Foot Type
1:Long straight
2:Outside Crimped
3:Short Straight
8:Vertical Crimped

Lead Length
S0~S9:1.0~1.9mm
X0~X9:2.0~2.9mm
A0~A9:3.0~3.9mm
B0~B9:4.0~4.9mm
C0~C9:5.0~5.9mm
D0~D9:6.0~6.9mm
E0~E9:7.0~7.9mm

Lead Length
F0~F9:8.0~8.9mm
G0~G9:9.0~9.9mm
H0~H9:10.0~10.9mm
J0~J9:11.0~11.9mm
K0~K9:12.0~12.9mm
L0~L9:13.0~13.9mm
M0~M9:14.0~14.9mm

Lead Length
M0~M9:14.0~14.9mm
N0:16~27.0mm(Bulk)
Crimped Lead Taped
N0:H0=16.5mm
P0:H0=17.0mm
Q0:H0=19.0mm
Straight Lead
Q0:20.0mm

Specifications

Capacitance and Dissipation factor testing condition	25°C、1KHz、1Vrms
Dissipation Factor(tanδ)	≤2.5%
Rated Voltage	250VAC
Withstand Voltage	2500VAC
Insulation Resistance (I.R.)	IR≥10000MΩ
Temperature Characteristic	Y5P、Y5U、Y5V

Dimensions (mm) and Approval

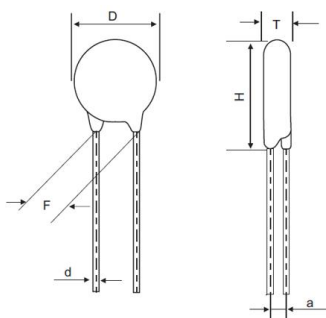

Part No.	Size (mm)				Approval				
	D Max.	T Max.	F±0.8	d±0.05	CQC	VDE	cUL (Canada)	KTL	ENEC
Y2-Y5P-101K	7.0	4.0	7.5	0.6	√	√	√	√	√
Y2-Y5P-151K	7.0	4.0	7.5	0.6	√	√	√	√	√
Y2-Y5P-221K	7.0	4.0	7.5	0.6	√	√	√	√	√
Y2-Y5P-331K	7.0	4.0	7.5	0.6	√	√	√	√	√
Y2-Y5P-471K	7.0	4.0	7.5	0.6	√	√	√	√	√
Y2-Y5P-681K	8.5	4.0	7.5	0.6	√		√	√	
Y2-Y5U-681M	7.0	4.0	7.5	0.6	√		√	√	
Y2-Y5U-102M	7.0	4.0	7.5	0.6	√	√	√	√	√
Y2-Y5U-152M	9.0	4.0	7.5	0.6	√	√	√	√	√
Y2-Y5U-222M	10.0	4.0	7.5	0.6	√	√	√	√	√
Y2-Y5U-332M	12.0	4.0	7.5	0.6	√	√	√	√	√
Y2-Y5U-472M	14.0	4.5	7.5 10.0	0.65	√	√	√	√	√
Y2-Y5U-103M	18.0	4.5	7.5 10.0	0.65	√	√	√	√	√
Y2-Y5V-152M	7.0	4.0	7.5	0.6	√	√	√	√	√
Y2-Y5V-222M	8.0	4.0	7.5	0.6	√	√	√	√	√



Safety Standard Certified Ceramic Capacitors-CE Series (Class Y2)

Part No.	Size (mm)				Approval					
	D Max.	T Max.	F±0.8		d±0.05	CQC	VDE	cUL (Canada)	KTL	ENEC
Y2-Y5V-332M	9.0	4.0	7.5		0.6	√	√	√	√	√
Y2-Y5V-472M	10.0	4.0	7.5		0.6	√	√	√	√	√
Y2-Y5V-103M	14.0	4.5	7.5	10.0	0.65	√	√	√	√	√

Lead Configuration

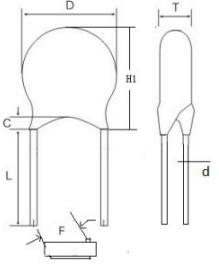
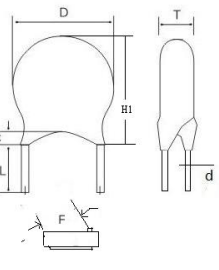
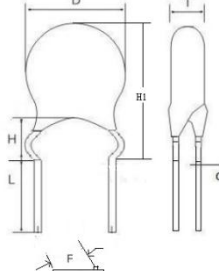
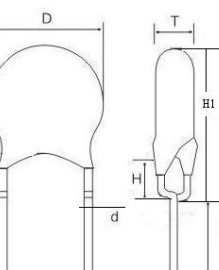
Lead Style	Drawing	Lead Length L (mm)	Coating Lead Length C (mm)	Height H (mm)
Long Straight		16.0 min	① C ≤ 2.5mm (Product diameter < 12mm) ② C ≤ 3.0mm (Product diameter ≥ 12mm)	/
Short Straight		① [2.5 ≤ L < 6.0] ± 0.5; ② [6.0 ≤ L ≤ 10] ± 1.0	① C ≤ 2.5mm (Product diameter < 12mm) ② C ≤ 3.0mm (Product diameter ≥ 12mm)	/
Outside Crimped		① [2.5 ≤ L < 6.0] ± 0.5; ② [6.0 ≤ L ≤ 10] ± 1.0	Not exceed the bend point	5.0mm Max
Vertical Crimped		① [2.5 ≤ L < 6.0] ± 0.5; ② [6.0 ≤ L ≤ 10] ± 1.0	Not exceed the bend point	4.0mm Max

Taping And Dimensions (mm)

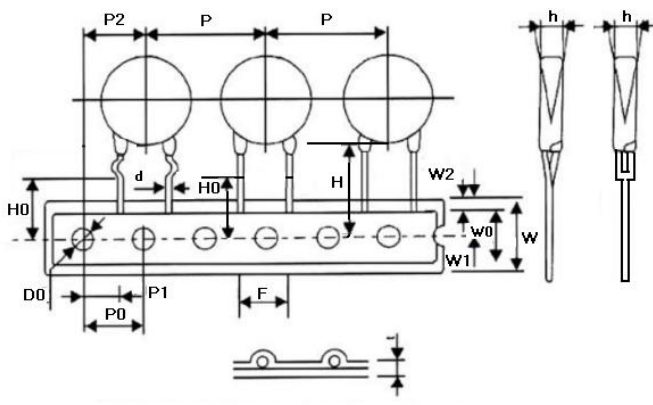
Figure	Symbol	P=7.5		P=10.0		
	Po	12.7±0.3		12.7±0.3		
	P	25.4±1.0		25.4±1.0		
	P1	8.95±0.7		7.7±0.7		
	P2	12.7±1.3		12.7±1.3		
	F	7.5±0.8		10.0±0.8		
	Δh	0±2.0		0±2.0		
	W	18.0 +1.5/-1.0		18.0 +1.5/-1.0		
	Wo	10.5 Max		10.5 Max		
	W1	9.0+0.75/-0.5		9.0+0.75/-0.5		
	W2	3.0 Max		3.0 Max		
	Do	4.0±0.2		4.0±0.2		
	H	20+1.5/-1.0		20+1.5/-1.0		
	Ho	16.5&17.0&19.0 +1.5/-1.0		16.5&17.0&19.0 +1.5/-1.0		
	L	Straight Lead			Straight Lead	Crimped Lead
			11.0 Max	9.0 Max	11.0 Max	9.0 Max
	t1	0.5±0.2		0.5±0.2		
	t2	1.7 Max		1.7 Max		