

- Features:
- AC operating voltage from 11V to 1000V
 - DC operating voltage from 14V to 1465V
 - Peak current up to 6500 amps
 - Energy handling up to 625J
 - UL1449 certified file no. E476752
 - Operating temperature range -40°C to +85°C
 - RoHS compliant, lead free and halogen free
 - Crimped and short lead styles available



Electrical Specifications – 5mm										
Part Number	Vn (V)	Vrms (V)	Vdc (V)	Vc (V)	Ic (A)	I _{max} (A)	W _{max} (J)	P (W)	C (pF)	T _{max} (mm)
RV180K05T	18	11	14	40	1	100	0.4	0.01	1400	4.5
RV220K05T	22	14	18	48	1	100	0.5	0.01	1150	4.5
RV270K05T	27	17	22	60	1	100	0.6	0.01	930	4.5
RV330K05T	33	20	26	73	1	100	0.8	0.01	760	4.5
RV390K05T	39	25	31	80	1	100	0.9	0.01	640	4.5
RV470K05T	47	30	38	104	1	100	1.1	0.01	530	4.5
RV560K05T	56	35	45	123	1	100	1.6	0.01	450	4.5
RV680K05T	68	40	56	145	1	100	2.5	0.01	370	4.5
RV820K05T	82	50	65	150	5	400	2.5	0.10	300	4.1
RV101K05T	100	60	85	175	5	400	3.0	0.10	250	4.3
RV121K05T	120	75	100	210	5	400	4.0	0.10	210	4.5
RV151K05T	150	95	125	260	5	400	4.8	0.10	165	4.8
RV181K05T	180	115	150	320	5	400	5.9	0.10	140	4.3
RV201K05T	200	130	170	355	5	400	6.5	0.10	125	4.4
RV221K05T	220	140	180	380	5	400	7.0	0.10	110	4.5
RV241K05T	240	150	200	415	5	400	8.0	0.10	100	4.6
RV271K05T	270	175	225	475	5	400	8.5	0.10	95	4.9
RV301K05T	300	190	250	520	5	400	9.0	0.10	85	5.0
RV331K05T	330	210	275	570	5	400	9.5	0.10	75	5.1
RV361K05T	360	230	300	620	5	400	10.0	0.10	70	5.2
RV391K05T	390	250	320	675	5	400	12.0	0.10	65	5.4
RV431K05T	430	275	350	745	5	400	13.0	0.10	60	5.7
RV471K05T	470	300	385	810	5	400	15.0	0.10	55	6.0
RV511K05T	510	320	415	845	5	400	16.0	0.10	50	6.2
RV561K05T	560	350	460	920	5	400	16.8	0.10	45	6.2

Part Number shown is for standard tape and reel packaging. Refer to How to Order section for other packaging options.

T_{max} = maximum part thickness

Electrical Specifications – 7mm										
Part Number	Vn (V)	Vrms (V)	Vdc (V)	Vc (V)	Ic (A)	I _{max} (A)	W _{max} (J)	P (W)	C (pF)	T _{max} (mm)
RV180K07T	18	11	14	36	2.5	250	0.9	0.02	2800	4.5
RV220K07T	22	14	18	43	2.5	250	1.1	0.02	2300	4.6
RV270K07T	27	17	22	53	2.5	250	1.4	0.02	1800	4.7
RV330K07T	33	20	26	65	2.5	250	1.7	0.02	1500	4.9
RV390K07T	39	25	31	77	2.5	250	2.1	0.02	1300	4.8
RV470K07T	47	30	38	93	2.5	250	2.5	0.02	1100	4.9
RV560K07T	56	35	45	110	2.5	250	3.1	0.02	890	5.0
RV680K07T	68	40	56	135	2.5	250	3.6	0.02	740	5.2
RV820K07T	82	50	65	135	10	1200	5.5	0.25	600	4.1
RV101K07T	100	60	85	165	10	1200	6.5	0.25	500	4.3
RV121K07T	120	75	100	200	10	1200	7.8	0.25	420	4.5

Electrical Specifications – 7mm

Part Number	Vn (V)	Vrms (V)	Vdc (V)	Vc (V)	Ic (A)	I _{max} (A)	W _{max} (J)	P (W)	C (pF)	T _{max} (mm)
RV151K07T	150	95	125	250	10	1200	9.7	0.25	330	4.8
RV181K07T	180	115	150	300	10	1200	11.7	0.25	280	4.3
RV201K07T	200	130	170	340	10	1200	13.0	0.25	250	4.4
RV221K07T	220	140	180	360	10	1200	14.0	0.25	230	4.5
RV241K07T	240	150	200	395	10	1200	15.0	0.25	210	4.6
RV271K07T	270	175	225	455	10	1200	18.0	0.25	185	4.9
RV301K07T	300	190	250	500	10	1200	20.0	0.25	165	5.0
RV331K07T	330	210	275	550	10	1200	23.0	0.25	150	5.1
RV361K07T	360	230	300	595	10	1200	24.0	0.25	140	5.2
RV391K07T	390	250	320	650	10	1200	26.0	0.25	130	5.4
RV431K07T	430	275	350	710	10	1200	28.0	0.25	115	5.7
RV471K07T	470	300	385	775	10	1200	29.0	0.25	105	6.0
RV511K07T	510	320	415	845	10	1200	31.0	0.25	100	6.4
RV561K07T	560	350	460	925	10	1200	35.0	0.25	90	6.4
RV621K07T	620	385	505	1025	10	1200	38.0	0.25	80	7.1
RV681K07T	680	420	560	1120	10	1200	42.0	0.25	75	7.4

Part Number shown is for standard tape and reel packaging. Refer to How to Order section for other packaging options.

T_{max} = maximum part thickness

Electrical Specifications – 10mm

Part Number	Vn (V)	Vrms (V)	Vdc (V)	Vc (V)	Ic (A)	I _{max} (A)	W _{max} (J)	P (W)	C (pF)	T _{max} (mm)
RV180L10T	18	11	14	36	5	500	2.1	0.05	5600	4.6
RV220L10T	22	14	18	43	5	500	2.5	0.05	9500	4.7
RV270L10T	27	17	22	53	5	500	3.0	0.05	3700	4.8
RV330L10T	33	20	26	65	5	500	4.0	0.05	3000	5.0
RV390K10T	39	25	31	77	5	500	4.6	0.05	2400	4.9
RV470K10T	47	30	38	93	5	500	5.5	0.05	2100	5.0
RV560K10T	56	35	45	110	5	500	7.0	0.05	1800	5.1
RV680K10T	68	40	56	135	5	500	8.2	0.05	1500	5.3
RV820K10T	82	50	65	135	25	2500	12.0	0.40	1200	4.5
RV101K10T	100	60	85	165	25	2500	15.0	0.40	1000	4.7
RV121K10T	120	75	100	200	25	2500	18.0	0.40	830	4.9
RV151K10T	150	95	125	250	25	2500	22.0	0.40	670	5.2
RV181K10T	180	115	150	300	25	2500	27.0	0.40	560	4.8
RV201K10T	200	130	170	340	25	2500	30.0	0.40	500	4.8
RV221K10T	220	140	180	360	25	2500	32.0	0.40	450	4.9
RV241K10T	240	150	200	395	25	2500	35.0	0.40	420	5.0
RV271K10T	270	175	225	455	25	2500	37.0	0.40	370	5.2
RV301K10T	300	190	250	500	25	2500	40.0	0.40	330	5.3
RV331K10T	330	210	275	550	25	2500	43.0	0.40	300	5.6
RV361K10T	360	230	300	595	25	2500	47.0	0.40	280	5.7
RV391K10T	390	250	320	650	25	2500	60.0	0.40	260	5.8
RV431K10T	430	275	350	710	25	2500	65.0	0.40	230	6.2
RV471K10T	470	300	385	775	25	2500	67.0	0.40	210	6.5
RV511K10T	510	320	415	845	25	2500	69.0	0.40	200	6.5
RV561K10T	560	350	460	925	25	2500	70.0	0.40	180	6.5
RV621K10T	620	385	505	1025	25	2500	72.0	0.40	160	7.1
RV681K10T	680	420	560	1120	25	2500	75.0	0.40	150	7.4
RV751K10T	750	460	615	1240	25	2500	77.0	0.40	130	7.8
RV781K10T	780	485	640	1290	25	2500	80.0	0.40	125	7.9
RV821K10T	820	510	670	1355	25	2500	85.0	0.40	120	8.1
RV911K10T	910	550	745	1500	25	2500	93.0	0.40	110	8.6
RV102K10T	1000	625	825	1650	25	2500	102.0	0.40	100	9.1
RV112K10T	1100	680	895	1815	25	2500	115.0	0.40	90	9.7

Part Number shown is for standard tape and reel packaging. Refer to How to Order section for other packaging options.

T_{max} = maximum part thickness

Electrical Specifications – 14mm

Part Number	Vn (V)	Vrms (V)	Vdc (V)	Vc (V)	Ic (A)	I _{max} (A)	W _{max} (J)	P (W)	C (pF)	T _{max} (mm)
RV180L14T	18	11	14	36	10	1000	4.0	0.10	11100	4.6
RV220L14T	22	14	18	43	10	1000	5.0	0.60	9100	4.7
RV270L14T	27	17	22	53	10	1000	6.0	0.10	7400	4.8
RV330L14T	33	20	26	65	10	1000	7.5	0.60	6100	5.0
RV390K14T	39	25	31	77	10	1000	8.6	0.10	5100	4.9
RV470K14T	47	30	38	93	10	1000	10.0	0.10	4300	5.0
RV560K14T	56	35	45	110	10	1000	11.0	0.10	3600	5.1
RV680K14T	68	40	56	135	10	1000	14.0	0.10	2900	5.3
RV820K14T	82	50	65	135	50	4500	22.0	0.60	2400	4.5
RV101K14T	100	60	85	165	50	4500	28.0	0.60	2000	4.7
RV121K14T	120	75	100	200	50	4500	32.0	0.60	1700	4.9
RV151K14T	150	95	125	250	50	4500	40.0	0.60	1300	5.2
RV181K14T	180	115	150	300	50	4500	50.0	0.60	1100	4.8
RV201K14T	200	130	170	340	50	4500	57.0	0.60	1000	4.8
RV221K14T	220	140	180	360	50	4500	60.0	0.60	900	4.9
RV241K14T	240	150	200	395	50	4500	63.0	0.60	830	5.0
RV271K14T	270	175	225	455	50	4500	70.0	0.60	740	5.2
RV301K14T	300	190	250	500	50	4500	77.0	0.60	670	5.3
RV331K14T	330	210	275	550	50	4500	85.0	0.60	610	5.6
RV361K14T	360	230	300	595	50	4500	93.0	0.60	560	5.7
RV391K14T	390	250	320	650	50	4500	100.0	0.60	510	5.8
RV431K14T	430	275	350	710	50	4500	115.0	0.60	460	6.2
RV471K14T	470	300	385	775	50	4500	118.0	0.60	430	6.5
RV511K14T	510	320	415	845	50	4500	121.0	0.60	390	6.5
RV561K14T	560	350	460	925	50	4500	125.0	0.60	360	6.5
RV621K14T	620	385	505	1025	50	4500	128.0	0.60	320	7.1
RV681K14T	680	420	560	1120	50	4500	130.0	0.60	290	7.4
RV751K14T	750	460	615	1240	50	4500	143.0	0.60	270	7.8
RV781K14T	780	485	640	1290	50	4500	148.0	0.60	260	7.9
RV821K14T	820	510	670	1355	50	4500	157.0	0.60	240	8.1
RV911K14T	910	550	745	1500	50	4500	175.0	0.60	220	8.6
RV102K14T	1000	625	825	1650	50	4500	190.0	0.60	200	9.1
RV112K14T	1100	680	895	1815	50	4500	213.0	0.60	180	9.7
RV182K14T	1800	1000	1465	2970	50	4500	250.0	0.60	130	14.4

Part Number shown is for standard tape and reel packaging. Refer to How to Order section for other packaging options.

T_{max} = maximum part thickness

Electrical Specifications – 20mm

Part Number	Vn (V)	Vrms (V)	Vdc (V)	Vc (V)	Ic (A)	I _{max} (A)	W _{max} (J)	P (W)	C (pF)	T _{max} (mm)
RV180K20T	18	11	14	36	20	2000	11.0	0.20	28500	5.3
RV220K20T	22	14	18	43	20	2000	14.0	0.20	18500	5.4
RV270K20T	27	17	22	53	20	2000	16.0	0.20	13000	5.5
RV330K20T	33	20	26	65	20	2000	23.0	0.20	11500	5.6
RV390LK0T	39	25	31	77	20	2000	26.0	0.20	8500	5.5
RV470K20T	47	30	38	93	20	2000	30.0	0.20	7400	5.6
RV560K20T	56	35	45	110	20	2000	38.0	0.20	6500	5.7
RV680K20T	68	40	56	135	20	2000	41.0	0.20	5800	5.8
RV820K20T	82	50	65	135	100	6500	45.0	1.00	4900	4.9
RV101K20T	100	60	85	165	100	6500	50.0	1.00	4000	5.1
RV121K20T	120	75	100	200	100	6500	55.0	1.00	3300	5.3
RV151K20T	150	95	125	250	100	6500	70.0	1.00	2700	5.6
RV181K20T	180	115	150	300	100	6500	85.0	1.00	2200	5.2
RV201K20T	200	130	170	340	100	6500	95.0	1.00	2000	5.2
RV221K20T	220	140	180	360	100	6500	100.0	1.00	1800	5.3
RV241K20T	240	150	200	395	100	6500	108.0	1.00	1650	5.4
RV271K20T	270	175	225	455	100	6500	127.0	1.00	1500	5.6

Electrical Specifications – 20mm (cont.)

Part Number	Vn (V)	Vrms (V)	Vdc (V)	Vc (V)	Ic (A)	I _{max} (A)	W _{max} (J)	P (W)	C (pF)	T _{max} (mm)
RV301K20T	300	190	250	500	100	6500	136.0	1.00	1300	5.7
RV331K20T	330	210	275	550	100	6500	150.0	1.00	1200	6.0
RV361K20T	360	230	300	595	100	6500	163.0	1.00	1100	6.2
RV391K20T	390	250	320	650	100	6500	180.0	1.00	1000	6.4
RV431K20T	430	275	350	710	100	6500	190.0	1.00	930	6.7
RV471K20T	470	300	385	775	100	6500	204.0	1.00	850	7.0
RV511K20T	510	320	415	845	100	6500	210.0	1.00	780	7.0
RV561K20T	560	350	460	925	100	6500	215.0	1.00	710	7.0
RV621K20T	620	385	505	1025	100	6500	224.0	1.00	650	7.5
RV681K20T	680	420	560	1120	100	6500	230.0	1.00	600	7.8
RV751K20T	750	460	615	1240	100	6500	255.0	1.00	530	8.2
RV781K20T	780	485	640	1290	100	6500	265.0	1.00	510	8.3
RV821K20T	820	510	670	1355	100	6500	282.0	1.00	500	8.5
RV911K20T	910	550	745	1500	100	6500	310.0	1.00	440	9.0
RV102K20T	1000	625	825	1650	100	6500	342.0	1.00	400	9.5
RV112K20T	1100	680	895	1815	100	6500	383.0	1.00	360	10.1
RV182K20T	1800	1000	1465	2970	100	6500	625.0	1.00	320	14.8

Part Number shown is for standard tape and reel packaging. Refer to How to Order section for other packaging options.
T_{max} = maximum part thickness

Performance Characteristics

Characteristics	Test Methods / Description	Specification														
Varistor Voltage (V _n)	The voltage between two terminals with the specified measuring current 1.0mA DC applied is called V _{1.0mA} . The measurement shall be made as fast as possible to avoid heat effect.	To meet the specified value.														
Maximum Allowable Voltage (V _{rms} and V _{dc})	The maximum sinusoidal RMS voltage or maximum DC voltage that can be applied continuously in the specified environmental temperature range.															
Clamping Voltage (Max.) (V _c)	The maximum voltage between two terminal with the specified standard impulse current (8/20us) illustrated below applied.															
Maximum Peak Current (Withstanding Surge Current) (I _{max})	The maximum current within the varistor voltage change of ±10% with the standard impulse current (8/20us) applied one time.	ΔV _{cmA} / V _{cmA} ≤ ±10% No damage.														
Maximum Energy (Joule) (W _{max})	The maximum energy within the varistor voltage change of ±10% when one impulse of 2ms or 10/1000us is applied.	To meet the specified value.														
Withstanding Voltage (Body Insulation)	The specified voltage shall be applied both terminals of the specimen connected together and metal foil closely wrapped round its body for 1 minute. Electrical breakdown shall be examined. Test voltage: 2500AC	No breakdown														
Robustness of Terminations (Tensile)	After gradually applying the force specified below and keeping the unit fixed for ten seconds, the terminal shall be visually examined for any damage. <table border="1" style="margin-left: auto; margin-right: auto;"> <thead> <tr> <th colspan="2">Terminal Diameter</th> <th rowspan="2">Force</th> </tr> <tr> <th>Inches</th> <th>mm</th> </tr> </thead> <tbody> <tr> <td>Φ 0.024</td> <td>Φ 0.60</td> <td>9.8N (1.0 kg)</td> </tr> <tr> <td>Φ 0.031</td> <td>Φ 0.80</td> <td>9.8N (1.0 kg)</td> </tr> <tr> <td>Φ 0.039</td> <td>Φ 1.00</td> <td>19.6N (2.0 kg)</td> </tr> </tbody> </table>	Terminal Diameter		Force	Inches	mm	Φ 0.024	Φ 0.60	9.8N (1.0 kg)	Φ 0.031	Φ 0.80	9.8N (1.0 kg)	Φ 0.039	Φ 1.00	19.6N (2.0 kg)	No visible damage.
Terminal Diameter		Force														
Inches	mm															
Φ 0.024	Φ 0.60	9.8N (1.0 kg)														
Φ 0.031	Φ 0.80	9.8N (1.0 kg)														
Φ 0.039	Φ 1.00	19.6N (2.0 kg)														

Performance Characteristics (cont.)																	
Characteristics	Test Methods / Description	Specification															
Robustness of Terminations (Bending)	<p>The unit shall be secured with its terminal kept vertical and the force specified below be applied in the axial direction. The terminal shall gradually be bent by 90° in one direction, then 90° in the opposite direction and again back to the original position. The damage of the terminal shall be visually examined.</p> <table border="1"> <thead> <tr> <th colspan="2">Terminal Diameter</th> <th rowspan="2">Force</th> </tr> <tr> <th>Inches</th> <th>mm</th> </tr> </thead> <tbody> <tr> <td>Φ 0.024</td> <td>Φ 0.60</td> <td>4.9N (0.5 kg)</td> </tr> <tr> <td>Φ 0.031</td> <td>Φ 0.80</td> <td>4.9N (0.5 kg)</td> </tr> <tr> <td>Φ 0.039</td> <td>Φ 1.00</td> <td>9.8N (1.0 kg)</td> </tr> </tbody> </table>	Terminal Diameter		Force	Inches	mm	Φ 0.024	Φ 0.60	4.9N (0.5 kg)	Φ 0.031	Φ 0.80	4.9N (0.5 kg)	Φ 0.039	Φ 1.00	9.8N (1.0 kg)	No visible damage.	
Terminal Diameter		Force															
Inches	mm																
Φ 0.024	Φ 0.60	4.9N (0.5 kg)															
Φ 0.031	Φ 0.80	4.9N (0.5 kg)															
Φ 0.039	Φ 1.00	9.8N (1.0 kg)															
Solderability	After dipping the terminals to a depth of approximately 3mm from the body in a soldering bat of 235±5 °C for 2±0.5 seconds. The terminal shall be visually examined.	Approximately 95% of the terminals shall be covered with solder uniformly.															
Resistance to Soldering Heat	After each lead shall be dipped into a solder a bath having a temperature 260 ± 5°C to a point 2.0 to 2.5mm from the body of the unit. Using shielding board (t=1.5mm) be held there for specified time 10 ± 1s and then be stored at room temperature and humidity for 1 to 2 hours. The change of Vc and mechanical damages are examined.	ΔVcmA / VcmA ≤ ±5% No visible damage.															
Vibration Resistance	The varistor should be soldered to the supporting lead wire and vibrated at a frequency range of 10 to 55Hz, 15mm. In total amplitude with about one minute rate of vibration charge from 10Hz to 55Hz and back to 10Hz. Apply for a total of 6 hours, 2 hours each in 3 mutually perpendicular directions.	ΔVcmA / VcmA ≤ ±5% No visible damage.															
Temperature Coefficient of Varistor Voltage	<p>Temperature Coefficient of Varistor Voltage</p> $\frac{Vc1-Vc2}{Vc2} \times \frac{1}{60} \times 100\%$ <p>Vc1=85°C Vc2=25°C</p>	± 0.05% / °C max															
High Temperature Storage Dry Heat	The specimen shall be subjected to 125 ± 2 °C for 1000 hours in a thermostatic bath without load and then stored at room temperature and humidity for 1 to 2 hours. Thereafter, the change of Vc shall be measured.	ΔVcmA / VcmA ≤ ±10% No visible damage.															
Damp Heat/Humidity Steady State	The specimen shall be subjected to 40 ± 2°C, 90 to 95% RH for 1000 hours without load and then stored at room temperature and humidity for 1 to 2 hours. Thereafter, the change of Vc shall be measured.	ΔVcmA / VcmA ≤ ±5% No visible damage.															
Temperature Cycle	<p>The temperature cycle shown below shall be repeated five times and then stored at room temperature and humidity for 1 to 2 hours. The change of Vc and mechanical damage shall be examined.</p> <table border="1"> <thead> <tr> <th>Step</th> <th>Temperature (°C)</th> <th>Period (minutes)</th> </tr> </thead> <tbody> <tr> <td>1</td> <td>-40 ± 3</td> <td>30 ± 3</td> </tr> <tr> <td>2</td> <td>Room temperature</td> <td>15 ± 3</td> </tr> <tr> <td>3</td> <td>125 ± 2</td> <td>30 ± 3</td> </tr> <tr> <td>4</td> <td>Room temperature</td> <td>15 ± 3</td> </tr> </tbody> </table>	Step	Temperature (°C)	Period (minutes)	1	-40 ± 3	30 ± 3	2	Room temperature	15 ± 3	3	125 ± 2	30 ± 3	4	Room temperature	15 ± 3	ΔVcmA / VcmA ≤ ±5% No visible damage.
Step	Temperature (°C)	Period (minutes)															
1	-40 ± 3	30 ± 3															
2	Room temperature	15 ± 3															
3	125 ± 2	30 ± 3															
4	Room temperature	15 ± 3															

Performance Characteristics (cont.)		
Characteristics	Test Methods / Description	Specification
High Temperature Load Dry Heat Load	After being continuously applied the Maximum Allowable Voltage at $85 \pm 2^\circ\text{C}$ for 1000 hours, the specimen shall be stored at room temperature and humidity for 1 to 2 hours. Thereafter, the change of V_c shall be examined.	$\Delta V_{cmA} / V_{cmA} \leq \pm 10\%$ No visible damage.
Damp Heat Load Humidity Load	The specimen shall be subjected to $40 \pm 2^\circ\text{C}$, 90 to 95% RH and the Maximum Allowable Voltage for 1000 hours and then stored at room temperature and humidity for 1 to 2 hours. Thereafter, the change of V_c shall be measured.	$\Delta V_{cmA} / V_{cmA} \leq \pm 10\%$ No visible damage.

Environment Test		
Temperature	Humidity	Atmospheric Pressure
15~35 °C	45~85%	86~105kPa

Unless otherwise specified, test and measurement shall be made at standard conditions.

Mechanical Specifications							
Straight Long No code		Straight Short Code = S		Vertical Crimped Code = V		Outside Crimped Long Code = C	Outside Crimped Short Code = D
Disc Size	5mm	7mm	10mm	14mm	20mm	Unit	
D max	0.295 7.50	0.354 9.00	0.551 14.00	0.669 17.00	0.984 25.00	inches mm	
d	0.024 0.60	0.024 0.60	0.031 0.80	0.031 0.80	0.031 0.80	inches mm	
F	0.197 ± 0.039 5.00 ± 1.00	0.197 ± 0.039 5.00 ± 1.00	0.295 ± 0.039 7.50 ± 1.00	0.295 ± 0.039 7.50 ± 1.00	0.394 ± 0.039 10.00 ± 1.00	inches mm	
P max(1)	0.118 3.00				0.157 4.00	inches mm	
H2 max	0.189 4.80					inches mm	
L(2) (bulk only)	0.709 18.00					inches mm	
T max	Refer to Electrical Specification chart above						

Notes: (1) 0.118"(3mm) Suitable for straight lead
(2) Lead length for short lead options can be customized to customer requirements

Taping Specifications – Straight Lead Style (long)

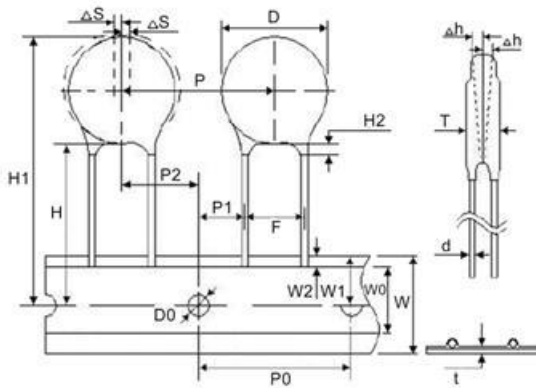

Figure 1

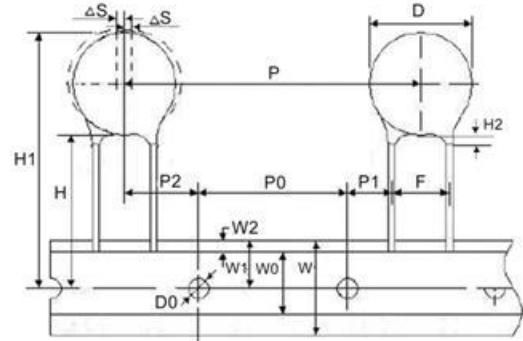

Figure 2

Symbol	Item	Component Pitch (P) = 12.70mm			Component Pitch (P) = 15.00mm			Unit
		5mm/7mm	10mm	14mm	5mm/7mm	10mm	14mm	
Refer to figures 1 and 2		Fig.1	Fig.1	Fig.2	Fig.1	Fig.1	Fig.2	
F	Lead to lead distance	0.197 ± 0.020 5.00 ± 0.50	0.295 ± 0.020 7.50 ± 0.50	0.295 ± 0.020 7.50 ± 0.50	0.197 ± 0.020 5.00 ± 0.50	0.295 ± 0.020 7.50 ± 0.50	0.295 ± 0.020 7.50 ± 0.50	inches mm
P	Pitch of component	0.500 ± 0.039 12.70 ± 1.00	0.500 ± 0.039 12.70 ± 1.00	1.000 ± 0.039 25.40 ± 1.00	0.591 ± 0.039 15.00 ± 1.00	0.591 ± 0.039 15.00 ± 1.00	1.181 ± 0.039 30.00 ± 1.00	inches mm
P0	Feed hole pitch	0.500 ± 0.012 12.70 ± 0.30	0.500 ± 0.012 12.70 ± 0.30	0.500 ± 0.012 12.70 ± 0.30	0.591 ± 0.012 15.00 ± 0.30	0.591 ± 0.012 15.00 ± 0.30	0.591 ± 0.012 15.00 ± 0.30	inches mm
P1	Feed hole center to lead center	0.152 ± 0.028 3.85 ± 0.70	0.102 ± 0.028 2.60 ± 0.70	0.102 ± 0.028 2.60 ± 0.70	0.197 ± 0.028 5.00 ± 0.70	0.148 ± 0.028 3.75 ± 0.70	0.148 ± 0.028 3.75 ± 0.70	inches mm
P2	Feed hole center to body center	0.250 ± 0.051 6.35 ± 1.30	0.250 ± 0.051 6.35 ± 1.30	0.250 ± 0.051 6.35 ± 1.30	0.295 ± 0.051 7.50 ± 1.30	0.295 ± 0.051 7.50 ± 1.30	0.295 ± 0.051 7.50 ± 1.30	inches mm
Δs	Component alignment R-L	0.000 ± 0.079 0.00 ± 2.00	0.000 ± 0.079 0.00 ± 2.00	0.000 ± 0.157 0.00 ± 4.00	0.000 ± 0.079 0.00 ± 2.00	0.000 ± 0.079 0.00 ± 2.00	0.000 ± 0.157 0.00 ± 4.00	inches mm
W	Tape width	0.709 ± 0.039 18.00 ± 1.00	0.709 ± 0.039 18.00 ± 1.00	0.709 ± 0.039 18.00 ± 1.00	0.709 ± 0.039 18.00 ± 1.00	0.709 ± 0.039 18.00 ± 1.00	0.709 ± 0.039 18.00 ± 1.00	inches mm
W0	Hole down tape width	0.315 min 8.00 min	0.315 min 8.00 min	0.315 min 8.00 min	0.315 min 8.00 min	0.315 min 8.00 min	0.315 min 8.00 min	inches mm
W1	Hole position	0.354 ± 0.020 9.00 ± 0.50	0.354 ± 0.020 9.00 ± 0.50	0.354 ± 0.020 9.00 ± 0.50	0.354 ± 0.020 9.00 ± 0.50	0.354 ± 0.020 9.00 ± 0.50	0.354 ± 0.020 9.00 ± 0.50	inches mm
W2	Hole down tape position	0.197 max 5.00 max	0.197 max 5.00 max	0.197 max 5.00 max	0.197 max 5.00 max	0.197 max 5.00 max	0.197 max 5.00 max	inches mm
H	Height of component from tape center	0.787 ± 0.079 20.00 ± 2.00	0.787 ± 0.079 20.00 ± 2.00	0.787 ± 0.079 20.00 ± 2.00	0.787 ± 0.079 20.00 ± 2.00	0.787 ± 0.079 20.00 ± 2.00	0.787 ± 0.079 20.00 ± 2.00	inches mm
H1	Component height	1.142 max 29.00 max	1.339 max 34.00 max	1.457 max 37.00 max	1.142 max 29.00 max	1.339 max 34.00 max	1.457 max 37.00 max	inches mm
H2	Dip length	0.118 max 3.00 max	0.118 max 3.00 max	0.118 max 3.00 max	0.118 max 3.00 max	0.118 max 3.00 max	0.118 max 3.00 max	inches mm
D0	Feed hole diameter	0.157 ± 0.008 4.00 ± 0.20	0.157 ± 0.008 4.00 ± 0.20	0.157 ± 0.008 4.00 ± 0.20	0.157 ± 0.008 4.00 ± 0.20	0.157 ± 0.008 4.00 ± 0.20	0.157 ± 0.008 4.00 ± 0.20	inches mm
t	Total tape thickness	0.024 ± 0.012 0.60 ± 0.30	0.024 ± 0.012 0.60 ± 0.30	0.024 ± 0.012 0.60 ± 0.30	0.024 ± 0.012 0.60 ± 0.30	0.024 ± 0.012 0.60 ± 0.30	0.024 ± 0.012 0.60 ± 0.30	inches mm
d	Wire diameter	0.024 ± 0.004 0.60 ± 0.10	0.031 ± 0.004 0.80 ± 0.10	0.031 ± 0.004 0.80 ± 0.10	0.024 ± 0.004 0.60 ± 0.10	0.031 ± 0.004 0.80 ± 0.10	0.031 ± 0.004 0.80 ± 0.10	inches mm
D	Max diameter	Refer to Mechanical Specifications						
T	Max thickness	Refer to Electrical Specifications						

Taping Specifications – Outside Crimped Lead Style (long)

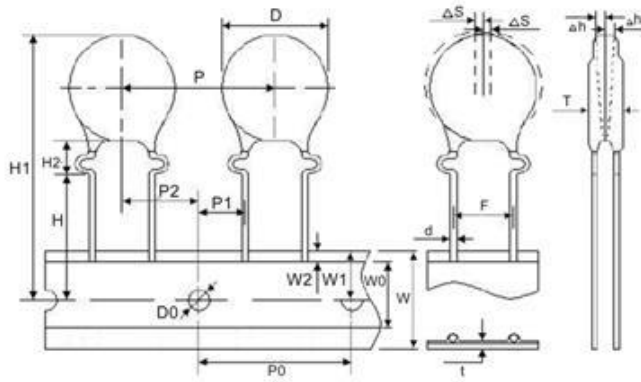

Figure 1

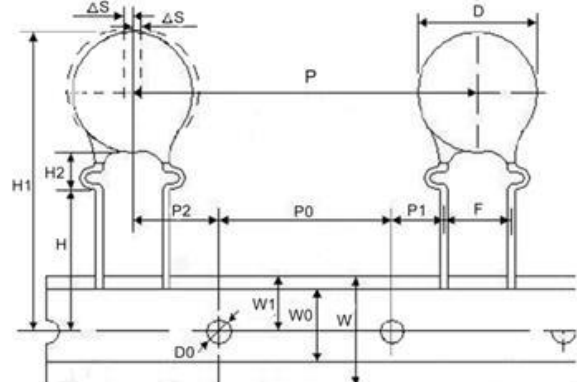

Figure 2

Symbol	Item	Component Pitch (P) = 12.70mm			Component Pitch (P) = 15.00mm			Unit
		5mm/7mm	10mm	14mm	5mm/7mm	10mm	14mm	
Refer to figures 1 and 2		Fig.1	Fig.1	Fig.2	Fig.1	Fig.1	Fig.2	
F	Lead to lead distance	0.197 ± 0.020 5.00 ± 0.50	0.295 ± 0.020 7.50 ± 0.50	0.295 ± 0.020 7.50 ± 0.50	0.197 ± 0.020 5.00 ± 0.50	0.295 ± 0.020 7.50 ± 0.50	0.295 ± 0.020 7.50 ± 0.50	inches mm
P	Pitch of component	0.500 ± 0.039 12.70 ± 1.00	0.500 ± 0.039 12.70 ± 1.00	1.000 ± 0.039 25.40 ± 1.00	0.591 ± 0.039 15.00 ± 1.00	0.591 ± 0.039 15.00 ± 1.00	1.181 ± 0.039 30.00 ± 1.00	inches mm
P0	Feed hole pitch	0.500 ± 0.012 12.70 ± 0.30	0.500 ± 0.012 12.70 ± 0.30	0.500 ± 0.012 12.70 ± 0.30	0.591 ± 0.012 15.00 ± 0.30	0.591 ± 0.012 15.00 ± 0.30	0.591 ± 0.012 15.00 ± 0.30	inches mm
P1	Feed hole center to lead center	0.152 ± 0.028 3.85 ± 0.70	0.102 ± 0.028 2.60 ± 0.70	0.102 ± 0.028 2.60 ± 0.70	0.197 ± 0.028 5.00 ± 0.70	0.148 ± 0.028 3.75 ± 0.70	0.148 ± 0.028 3.75 ± 0.70	inches mm
P2	Feed hole center to body center	0.250 ± 0.051 6.35 ± 1.30	0.250 ± 0.051 6.35 ± 1.30	0.250 ± 0.051 6.35 ± 1.30	0.295 ± 0.051 7.50 ± 1.30	0.295 ± 0.051 7.50 ± 1.30	0.295 ± 0.051 7.50 ± 1.30	inches mm
Δs	Component alignment R-L	0.000 ± 0.079 0.00 ± 2.00	0.000 ± 0.079 0.00 ± 2.00	0.000 ± 0.157 0.00 ± 4.00	0.000 ± 0.079 0.00 ± 2.00	0.000 ± 0.079 0.00 ± 2.00	0.000 ± 0.157 0.00 ± 4.00	inches mm
W	Tape width	0.709 ± 0.039 18.00 ± 1.00	0.709 ± 0.039 18.00 ± 1.00	0.709 ± 0.039 18.00 ± 1.00	0.709 ± 0.039 18.00 ± 1.00	0.709 ± 0.039 18.00 ± 1.00	0.709 ± 0.039 18.00 ± 1.00	inches mm
W0	Hole down tape width	0.315 min 8.00 min	0.315 min 8.00 min	0.315 min 8.00 min	0.315 min 8.00 min	0.315 min 8.00 min	0.315 min 8.00 min	inches mm
W1	Hole position	0.354 ± 0.020 9.00 ± 0.50	0.354 ± 0.020 9.00 ± 0.50	0.354 ± 0.020 9.00 ± 0.50	0.354 ± 0.020 9.00 ± 0.50	0.354 ± 0.020 9.00 ± 0.50	0.354 ± 0.020 9.00 ± 0.50	inches mm
W2	Hole down tape position	0.197 max 5.00 max	0.197 max 5.00 max	0.197 max 5.00 max	0.197 max 5.00 max	0.197 max 5.00 max	0.197 max 5.00 max	inches mm
H	Height of component from tape center	0.630 ± 0.079 16.00 ± 2.00	0.630 ± 0.079 16.00 ± 2.00	0.630 ± 0.079 16.00 ± 2.00	0.630 ± 0.079 16.00 ± 2.00	0.630 ± 0.079 16.00 ± 2.00	0.630 ± 0.079 16.00 ± 2.00	inches mm
H1	Component height	1.142 max 29.00 max	1.339 max 34.00 max	1.457 max 37.00 max	1.142 max 29.00 max	1.339 max 34.00 max	1.457 max 37.00 max	inches mm
H2	Dip length	0.189 max 4.80 max	0.189 max 4.80 max	0.189 max 4.80 max	0.189 max 4.80 max	0.189 max 4.80 max	0.189 max 4.80 max	inches mm
D0	Feed hole diameter	0.157 ± 0.008 4.00 ± 0.20	0.157 ± 0.008 4.00 ± 0.20	0.157 ± 0.008 4.00 ± 0.20	0.157 ± 0.008 4.00 ± 0.20	0.157 ± 0.008 4.00 ± 0.20	0.157 ± 0.008 4.00 ± 0.20	inches mm
t	Total tape thickness	0.024 ± 0.012 0.60 ± 0.30	0.024 ± 0.012 0.60 ± 0.30	0.024 ± 0.012 0.60 ± 0.30	0.024 ± 0.012 0.60 ± 0.30	0.024 ± 0.012 0.60 ± 0.30	0.024 ± 0.012 0.60 ± 0.30	inches mm
d	Wire diameter	0.024 ± 0.004 0.60 ± 0.10	0.031 ± 0.004 0.80 ± 0.10	0.031 ± 0.004 0.80 ± 0.10	0.024 ± 0.004 0.60 ± 0.10	0.031 ± 0.004 0.80 ± 0.10	0.031 ± 0.004 0.80 ± 0.10	inches mm
D	Max diameter	Refer to Mechanical Specifications						
T	Max thickness	Refer to Electrical Specifications						

Taping Specifications – Vertical Crimped Lead Style

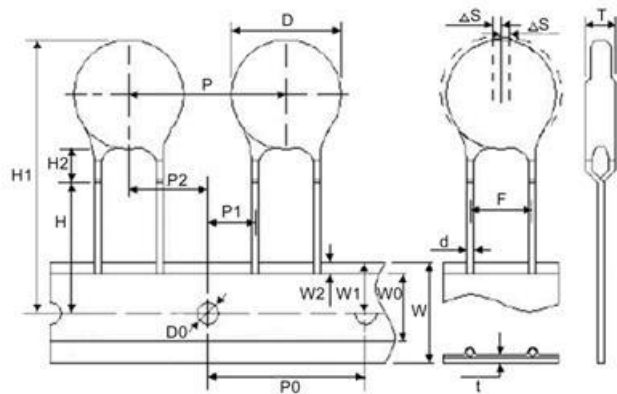

Figure 1

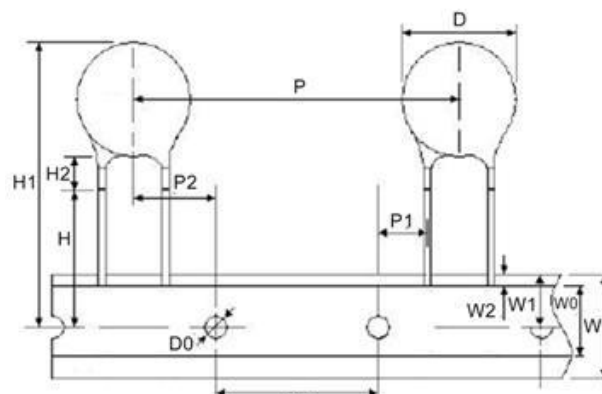
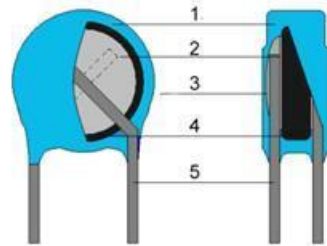

Figure 2

Symbol	Item	Component Pitch (P) = 12.70mm			Component Pitch (P) = 15.00mm			Unit
		5mm/7mm	10mm	14mm	5mm/7mm	10mm	14mm	
Refer to figures 1 and 2		Fig.1	Fig.1	Fig.2	Fig.1	Fig.1	Fig.2	
F	Lead to lead distance	0.197 ± 0.020 5.00 ± 0.50	0.295 ± 0.020 7.50 ± 0.50	0.295 ± 0.020 7.50 ± 0.50	0.197 ± 0.020 5.00 ± 0.50	0.295 ± 0.020 7.50 ± 0.50	0.295 ± 0.020 7.50 ± 0.50	inches mm
P	Pitch of component	0.500 ± 0.039 12.70 ± 1.00	0.500 ± 0.039 12.70 ± 1.00	1.000 ± 0.039 25.40 ± 1.00	0.591 ± 0.039 15.00 ± 1.00	0.591 ± 0.039 15.00 ± 1.00	1.181 ± 0.039 30.00 ± 1.00	inches mm
P0	Feed hole pitch	0.500 ± 0.012 12.70 ± 0.30	0.500 ± 0.012 12.70 ± 0.30	0.500 ± 0.012 12.70 ± 0.30	0.591 ± 0.012 15.00 ± 0.30	0.591 ± 0.012 15.00 ± 0.30	0.591 ± 0.012 15.00 ± 0.30	inches mm
P1	Feed hole center to lead center	0.152 ± 0.028 3.85 ± 0.70	0.102 ± 0.028 2.60 ± 0.70	0.102 ± 0.028 2.60 ± 0.70	0.197 ± 0.028 5.00 ± 0.70	0.148 ± 0.028 3.75 ± 0.70	0.148 ± 0.028 3.75 ± 0.70	inches mm
P2	Feed hole center to body center	0.250 ± 0.051 6.35 ± 1.30	0.250 ± 0.051 6.35 ± 1.30	0.250 ± 0.051 6.35 ± 1.30	0.295 ± 0.051 7.50 ± 1.30	0.295 ± 0.051 7.50 ± 1.30	0.295 ± 0.051 7.50 ± 1.30	inches mm
Δs	Component alignment R-L	0.000 ± 0.079 0.00 ± 2.00	0.000 ± 0.079 0.00 ± 2.00	0.000 ± 0.157 0.00 ± 4.00	0.000 ± 0.079 0.00 ± 2.00	0.000 ± 0.079 0.00 ± 2.00	0.000 ± 0.157 0.00 ± 4.00	inches mm
W	Tape width	0.709 ± 0.039 18.00 ± 1.00	0.709 ± 0.039 18.00 ± 1.00	0.709 ± 0.039 18.00 ± 1.00	0.709 ± 0.039 18.00 ± 1.00	0.709 ± 0.039 18.00 ± 1.00	0.709 ± 0.039 18.00 ± 1.00	inches mm
W0	Hole down tape width	0.315 min 8.00 min	0.315 min 8.00 min	0.315 min 8.00 min	0.315 min 8.00 min	0.315 min 8.00 min	0.315 min 8.00 min	inches mm
W1	Hole position	0.354 ± 0.020 9.00 ± 0.50	0.354 ± 0.020 9.00 ± 0.50	0.354 ± 0.020 9.00 ± 0.50	0.354 ± 0.020 9.00 ± 0.50	0.354 ± 0.020 9.00 ± 0.50	0.354 ± 0.020 9.00 ± 0.50	inches mm
W2	Hole down tape position	0.197 max 5.00 max	0.197 max 5.00 max	0.197 max 5.00 max	0.197 max 5.00 max	0.197 max 5.00 max	0.197 max 5.00 max	inches mm
H	Height of component from tape center	0.630 ± 0.079 16.00 ± 2.00	0.630 ± 0.079 16.00 ± 2.00	0.630 ± 0.079 16.00 ± 2.00	0.630 ± 0.079 16.00 ± 2.00	0.630 ± 0.079 16.00 ± 2.00	0.630 ± 0.079 16.00 ± 2.00	inches mm
H1	Component height	1.142 max 29.00 max	1.339 max 34.00 max	1.457 max 37.00 max	1.142 max 29.00 max	1.339 max 34.00 max	1.457 max 37.00 max	inches mm
H2	Dip length	0.189 max 4.80 max	0.189 max 4.80 max	0.189 max 4.80 max	0.189 max 4.80 max	0.189 max 4.80 max	0.189 max 4.80 max	inches mm
D0	Feed hole diameter	0.157 ± 0.008 4.00 ± 0.20	0.157 ± 0.008 4.00 ± 0.20	0.157 ± 0.008 4.00 ± 0.20	0.157 ± 0.008 4.00 ± 0.20	0.157 ± 0.008 4.00 ± 0.20	0.157 ± 0.008 4.00 ± 0.20	inches mm
t	Total tape thickness	0.024 ± 0.012 0.60 ± 0.30	0.024 ± 0.012 0.60 ± 0.30	0.024 ± 0.012 0.60 ± 0.30	0.024 ± 0.012 0.60 ± 0.30	0.024 ± 0.012 0.60 ± 0.30	0.024 ± 0.012 0.60 ± 0.30	inches mm
d	Wire diameter	0.024 ± 0.004 0.60 ± 0.10	0.031 ± 0.004 0.80 ± 0.10	0.031 ± 0.004 0.80 ± 0.10	0.024 ± 0.004 0.60 ± 0.10	0.031 ± 0.004 0.80 ± 0.10	0.031 ± 0.004 0.80 ± 0.10	inches mm
D	Max diameter	Refer to Mechanical Specifications						
T	Max thickness	Refer to Electrical Specifications						

Component Structure



Ref. No.	Part	Name	Material	CAS No.	Component Percentage	Material Percentage
1	Coating	Epoxy Resin UL94-V0	Epoxy resin	25036-25-3	32%	50%
			SiO ₂	60676-86-0		45%
			Sb ₂ O ₃	1309-64-4		5%
2	Electrode	Silver	Ag	7440-22-4	4%	100%
3	Solder	Alloy Tin	Sn	7440-31-5	10%	96.50%
			Ag	7440-22-4		3%
			Cu	7440-50-8		0.50%
4	Dielectric	ZnO	ZnO	1314-13-2	38%	100%
5	Lead Wire	CP	Fe	7439-89-6	16%	87%
			Cu	7440-50-8		10%
			Sn	7440-31-5		3%

Lead Wire Structure

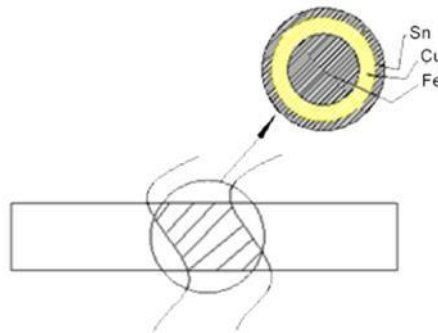

Marking Explanation

Type	Pattern	Explanation
Standard Type		Common code Diameter/Appearance/Varistor Voltage/Tolerance

Safety Standard Approvals			
Safety Standard	Recognized No.	Range	Standard No.
UL	E476752	05mm (180K~561K) 07mm (180K~681K) 10mm (180L~112K) 14mm (180L~182K) 20mm (180K~182K)	UL1449 other type

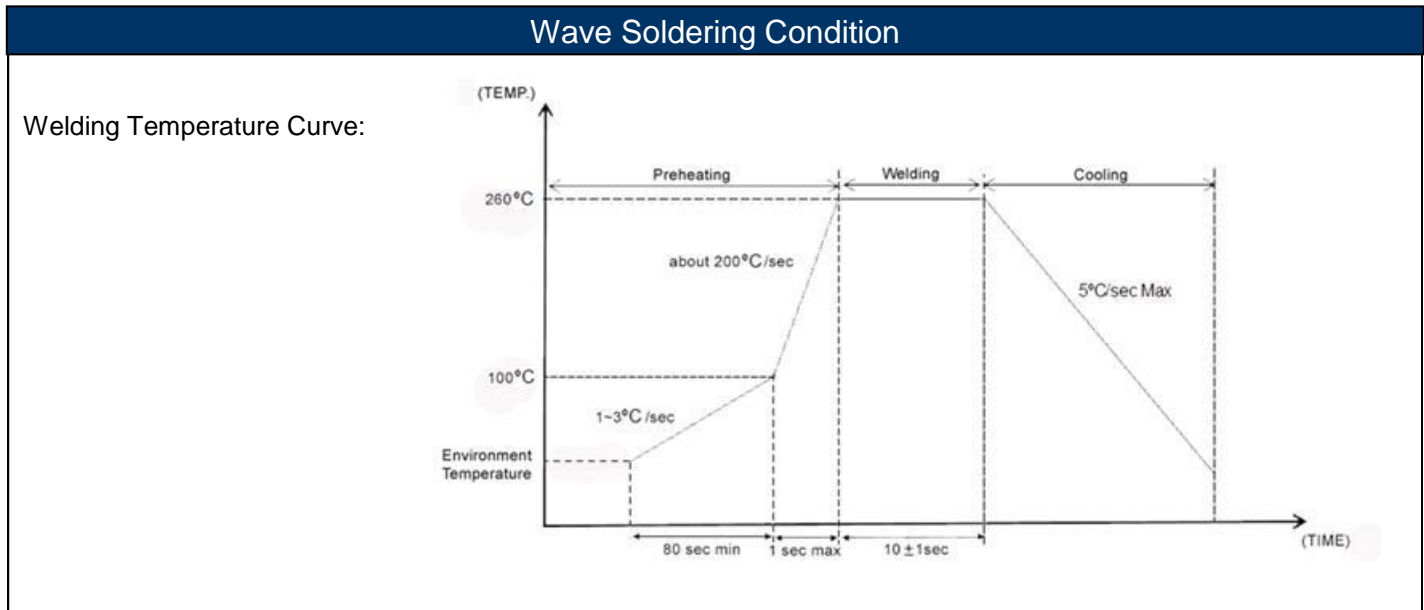

Soldering Iron Welding Specifications	
Solder Iron Temperature	350°C ± 10°C
Welding Time	3 seconds max
Welding Position	2mm min
Distance Coating Position	

Packaging Specifications		
Inner Bag	Inner Box	Outer Box
<p>Position of label</p>	<p>120mm 360mm 180mm</p>	<p>250mm 375mm 370mm</p> <p>P.O.No. C.No. N.W. G.W.</p> <p>Customer Name Customer P/N SEI P/N QTY</p>

Packing Specifications - Ammo		
Tape Folding	Inner Box	Outer Box

Reel Specifications

Packaging Specifications – Bulk	
Type	Package Quantity (*)
5mm	1000
7mm	1000
10mm	500
14mm	250
20mm	100

(*) Contact Stackpole Electronics for MOQ

Packaging Specifications – Ammo & Reel		
Type	Package Quantity (*)	
	Ammo	Reel
5mm	1000	1000
7mm	1000	1000
10mm	500	500
14mm	500	500

(*) Contact Stackpole Electronics for MOQ

Storage Specifications	
Storage Temperature	-10~40°C
Relative Humidity	≤ 75% RH
Storage Period	1 year
Operation Temperature Range	-40~85°C
Do not use this product in corrosive gases or in direct sunlight environment preservation.	

Impulse Lifetime Ratings

2 times: 5 minutes interval
Up to 10 times: 2 minutes interval
Up to 10^6 times: 10 seconds interval

5mm 180K-680K

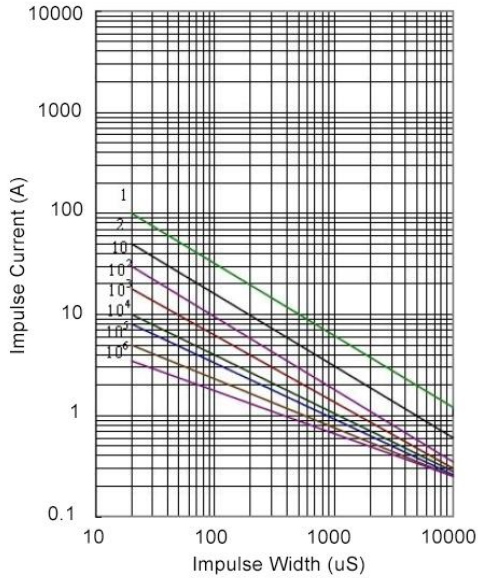

5mm 820K-561K

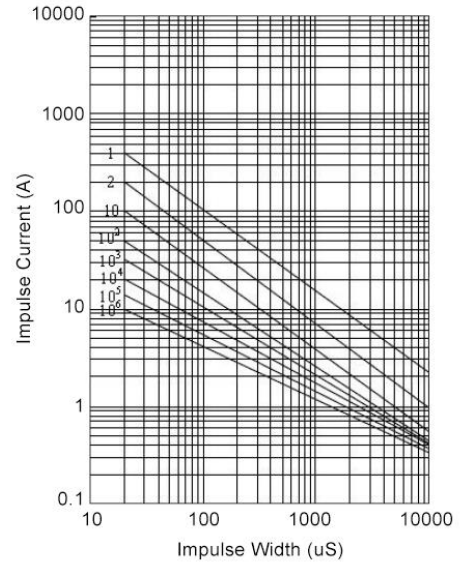

7mm 180K-680K

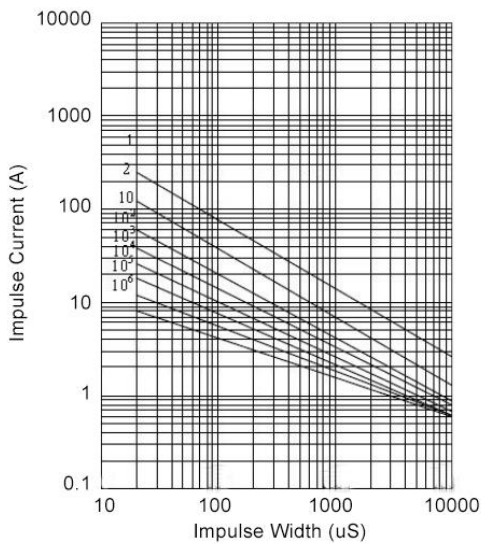

7mm 820K-471K

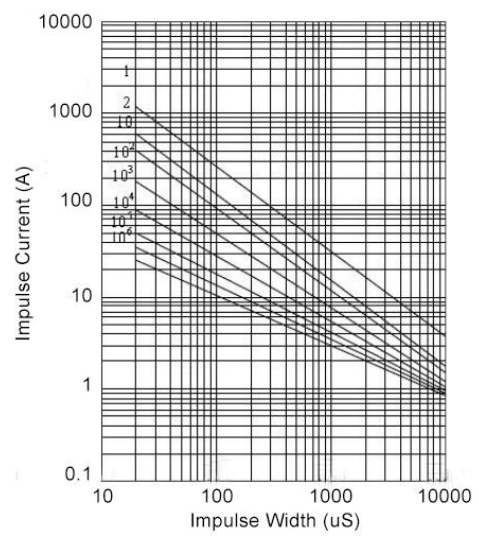

Impulse Lifetime Ratings

2 times: 5 minutes interval
Up to 10 times: 2 minutes interval
Up to 10^6 times: 10 seconds interval

7mm 511K-681K

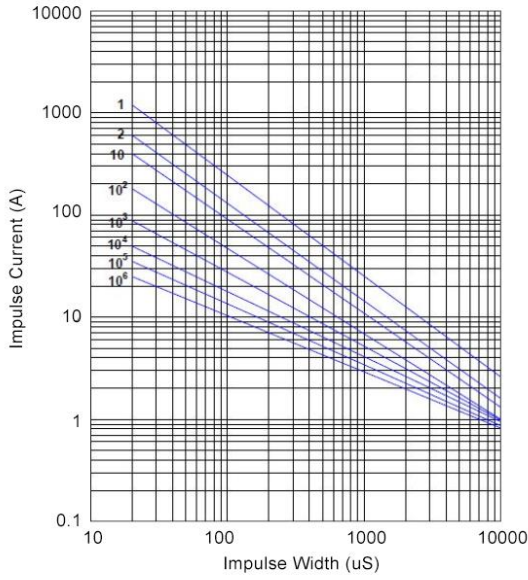

10mm 180L-680K

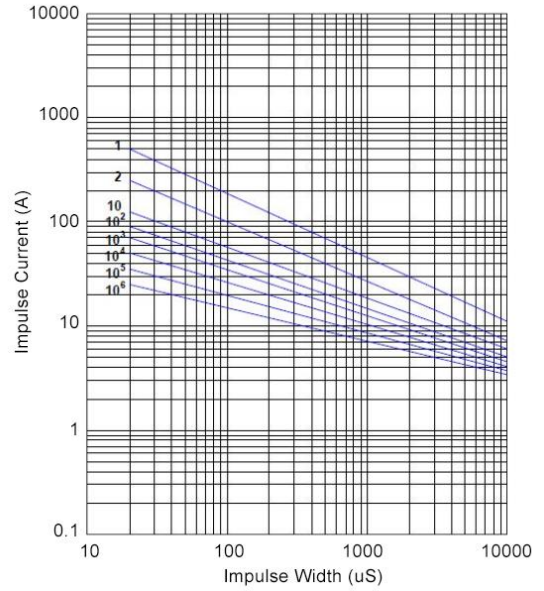

10mm 820K-751K

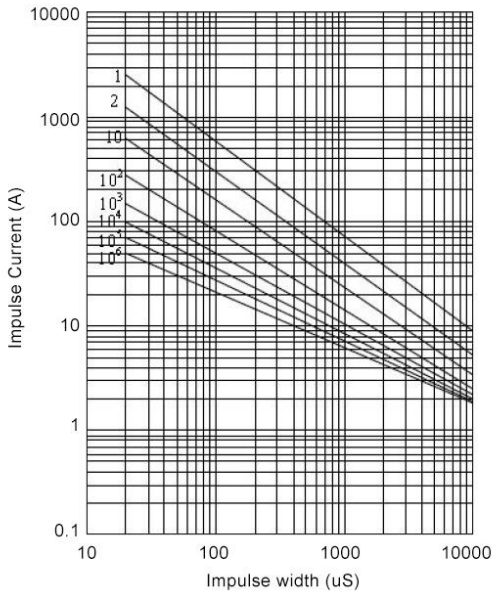

10mm 821K-112K

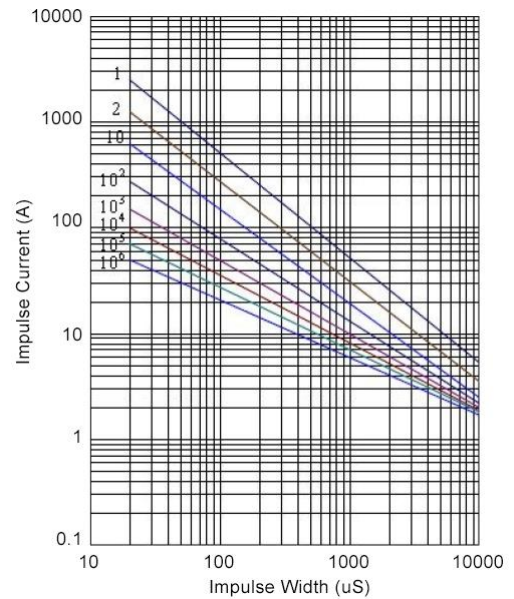

Impulse Lifetime Ratings

2 times: 5 minutes interval
Up to 10 times: 2 minutes interval
Up to 10^6 times: 10 seconds interval

14mm 180L-680K

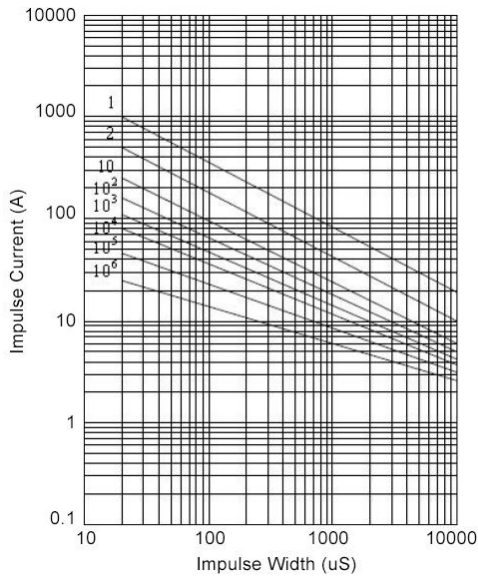

14mm 820K-751K

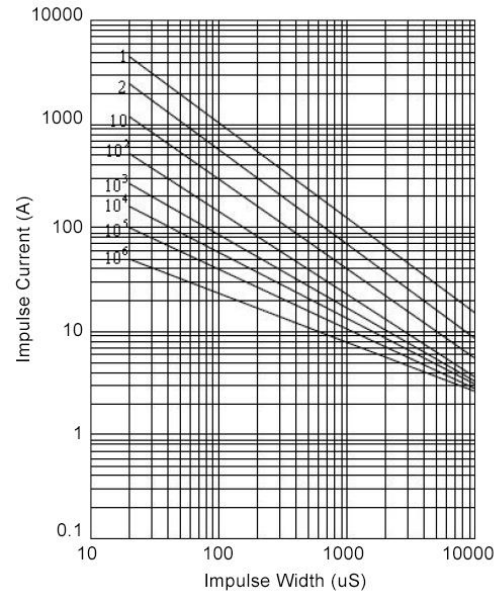

14mm 821K-182K

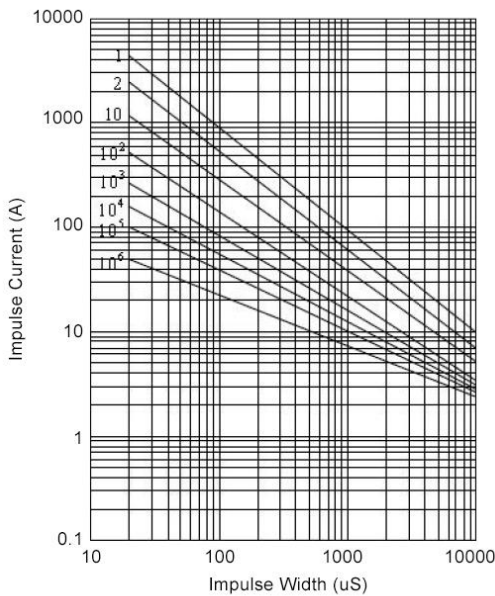

20mm 180K-680K

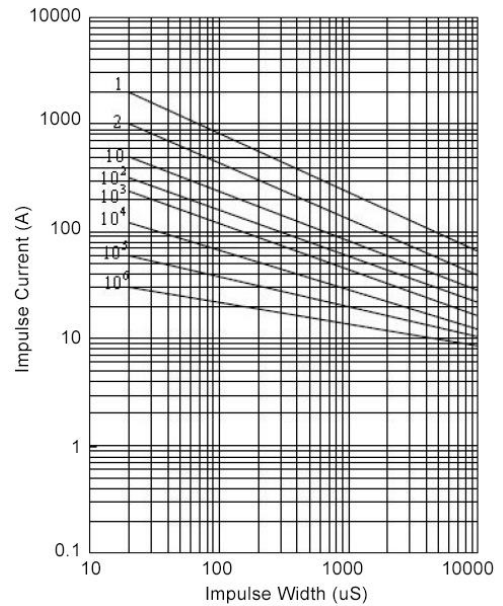

Impulse Lifetime Ratings

2 times: 5 minutes interval
Up to 10 times: 2 minutes interval
Up to 10^6 times: 10 seconds interval

20mm 820K-751K

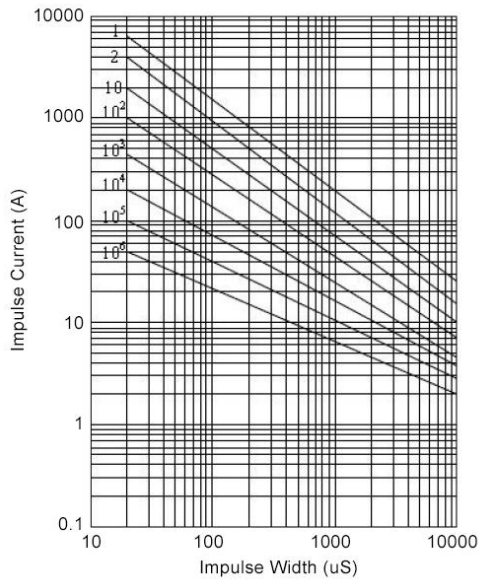

20mm 821K-182K

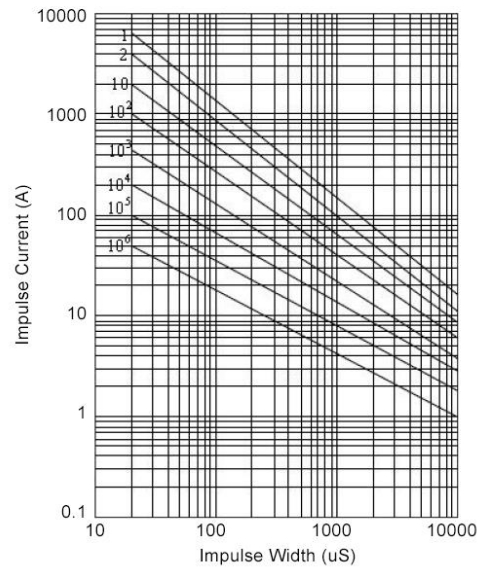

Voltage Curve – 5mm 180K-680K

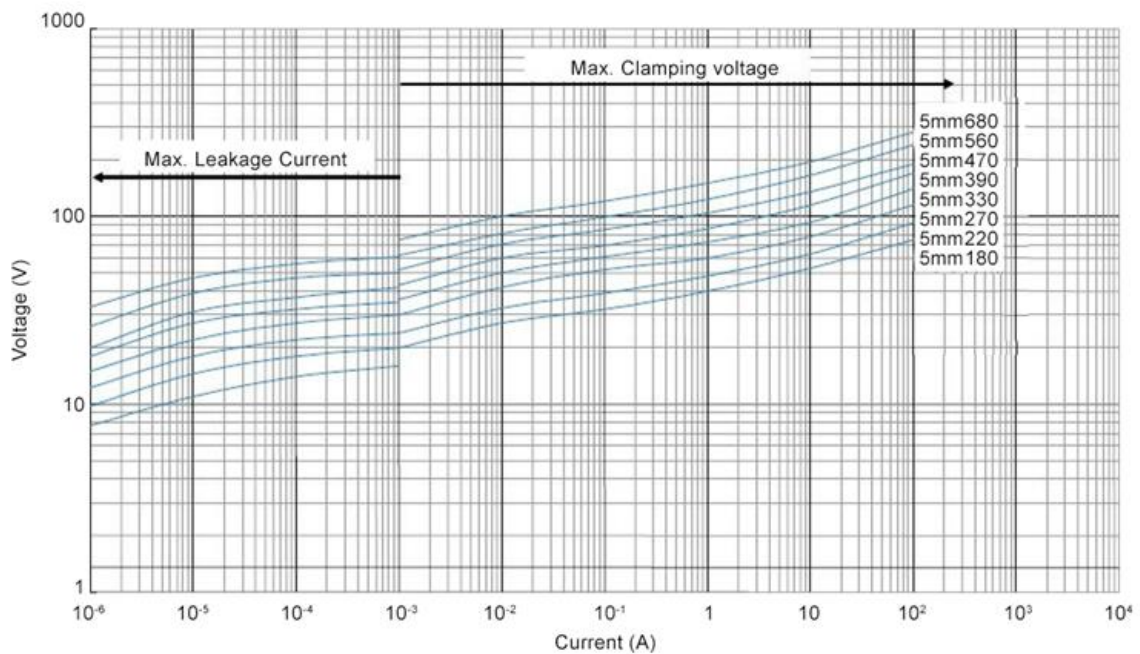

Voltage Curve – 5mm 820K-751K

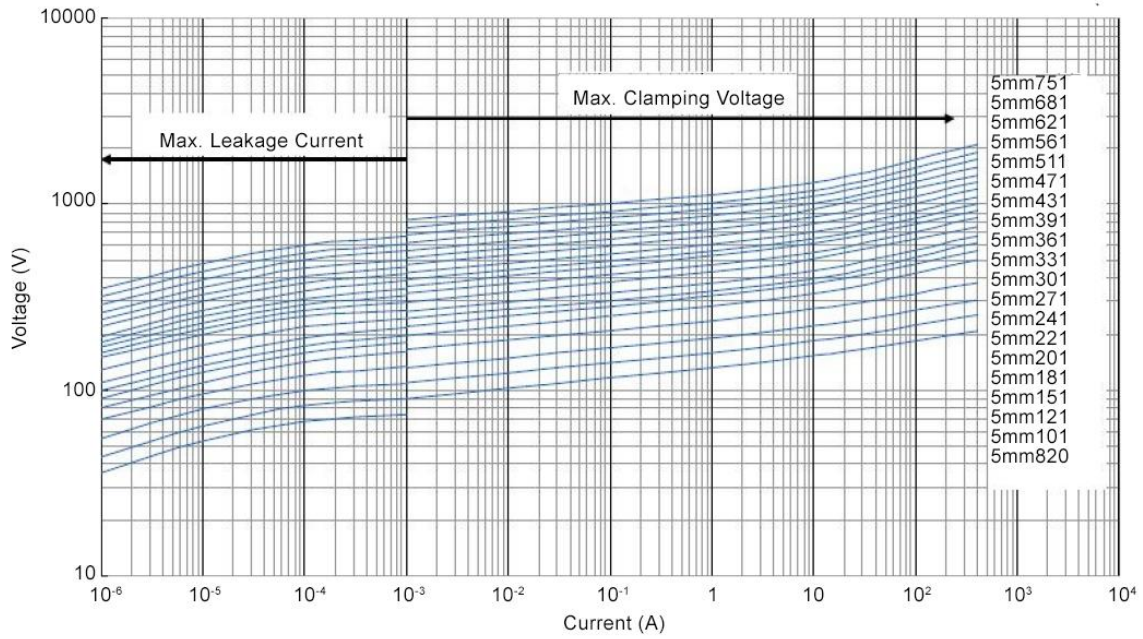

Voltage Curve – 7mm 180K-680K

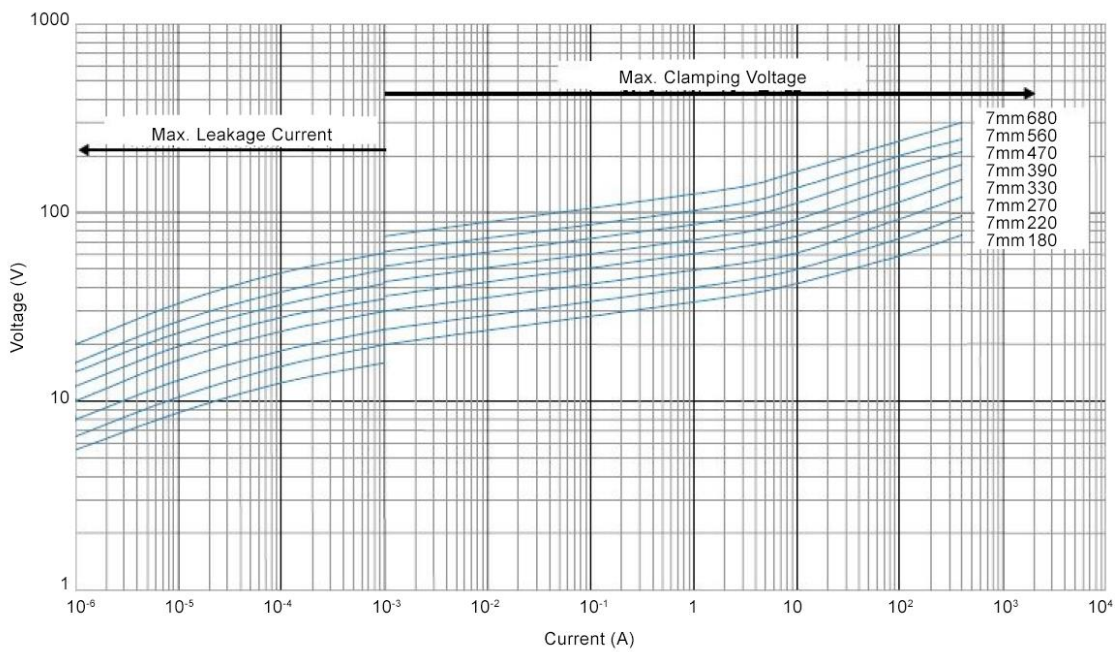

Voltage Curve – 7mm 820K-471K

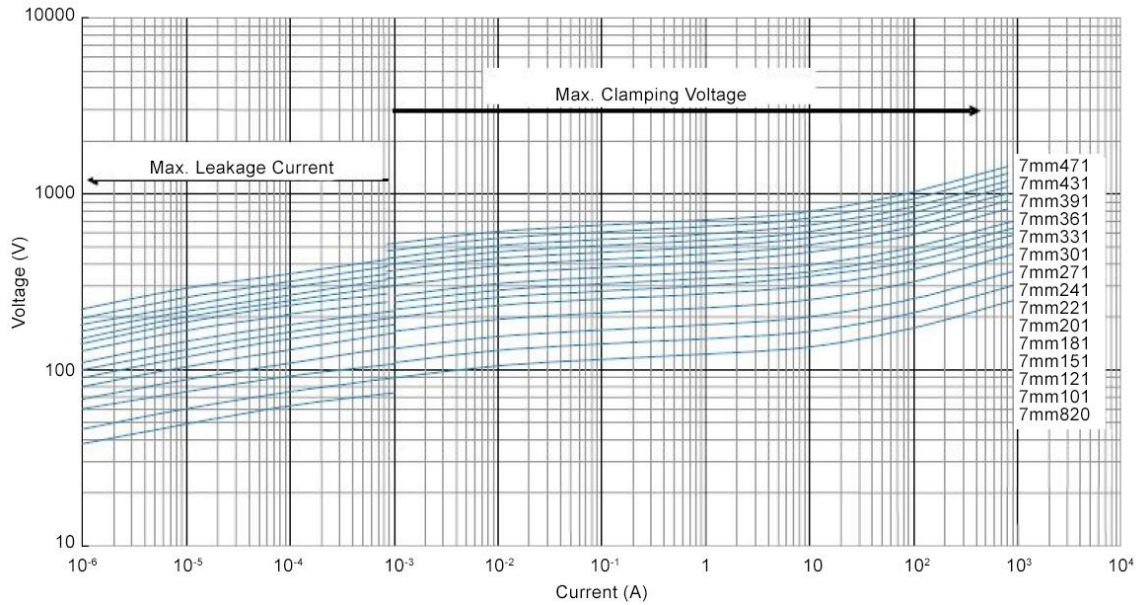

Voltage Curve – 7mm 511K – 821K

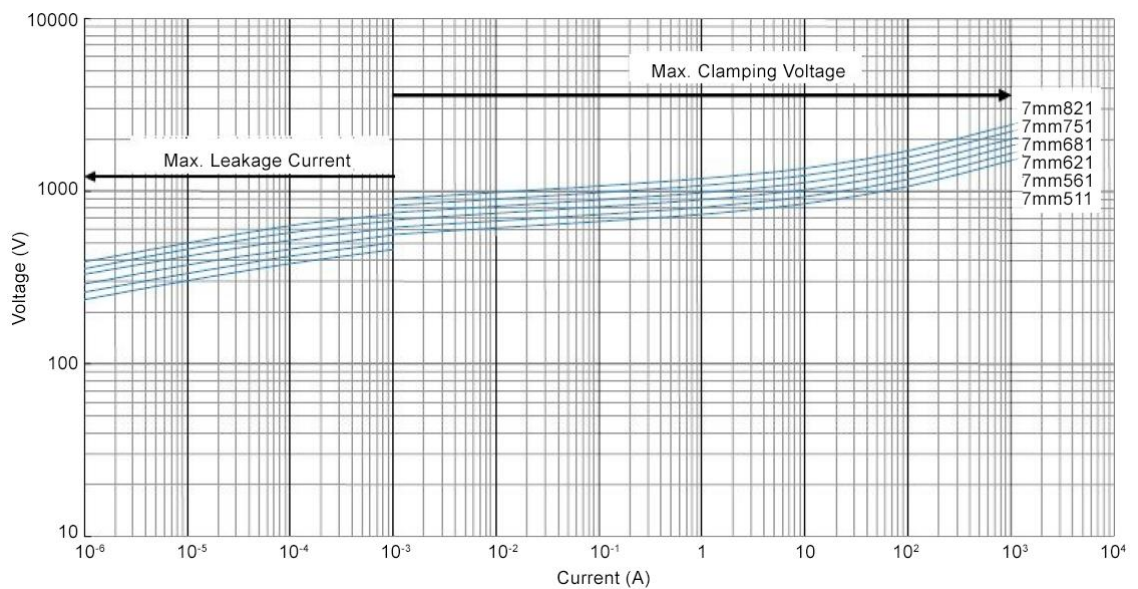

Voltage Curve – 10mm 180L-680K

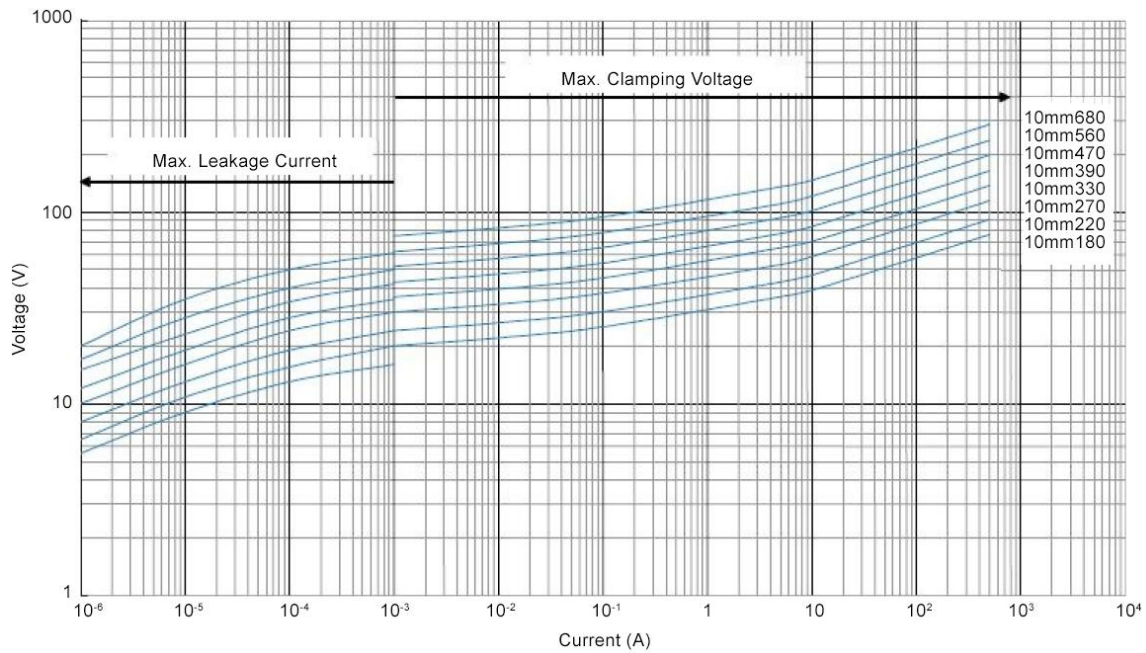

Voltage Curve – 10mm 820K-751K

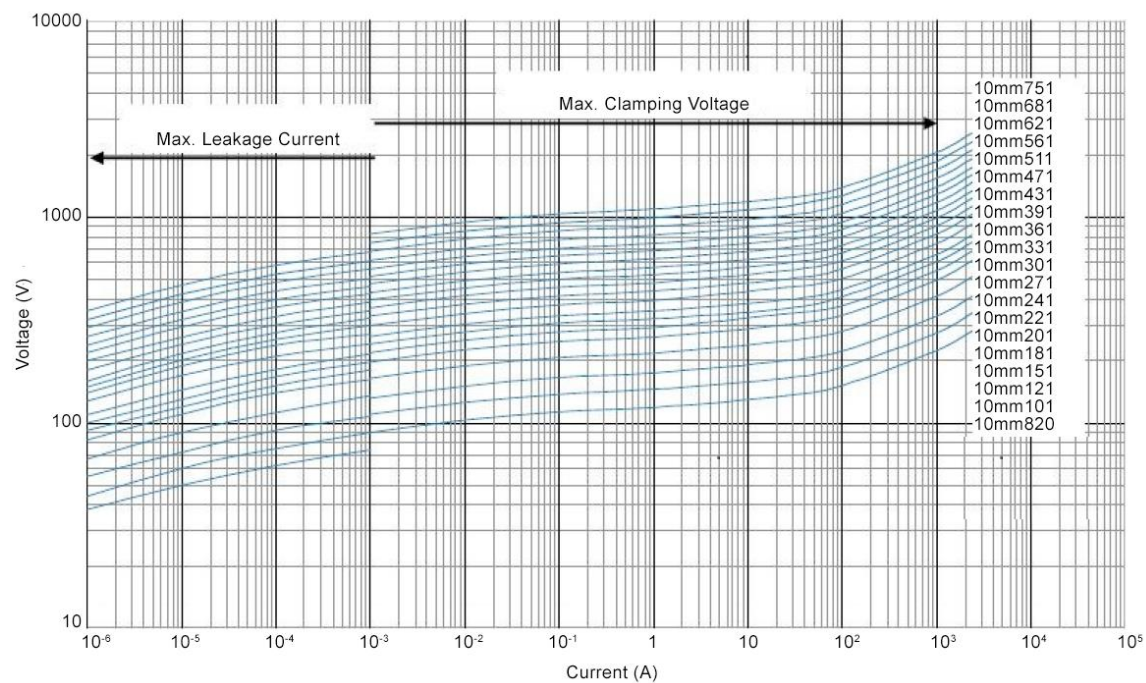

Voltage Curve – 10mm 821K-182K

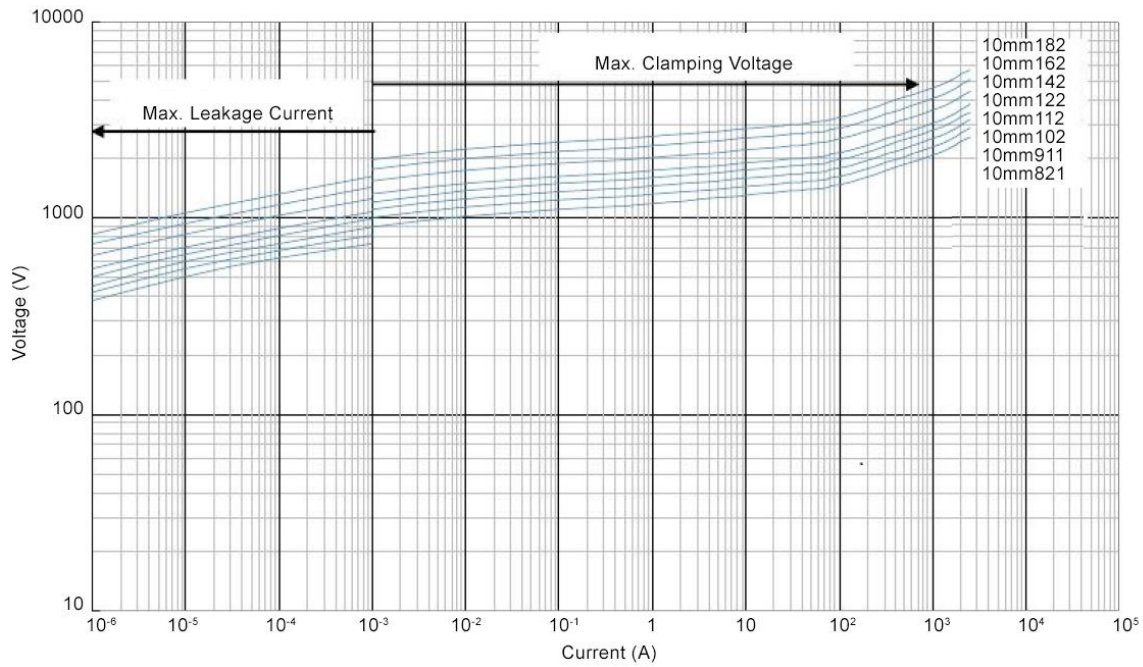

Voltage Curve – 14mm 180L-680K

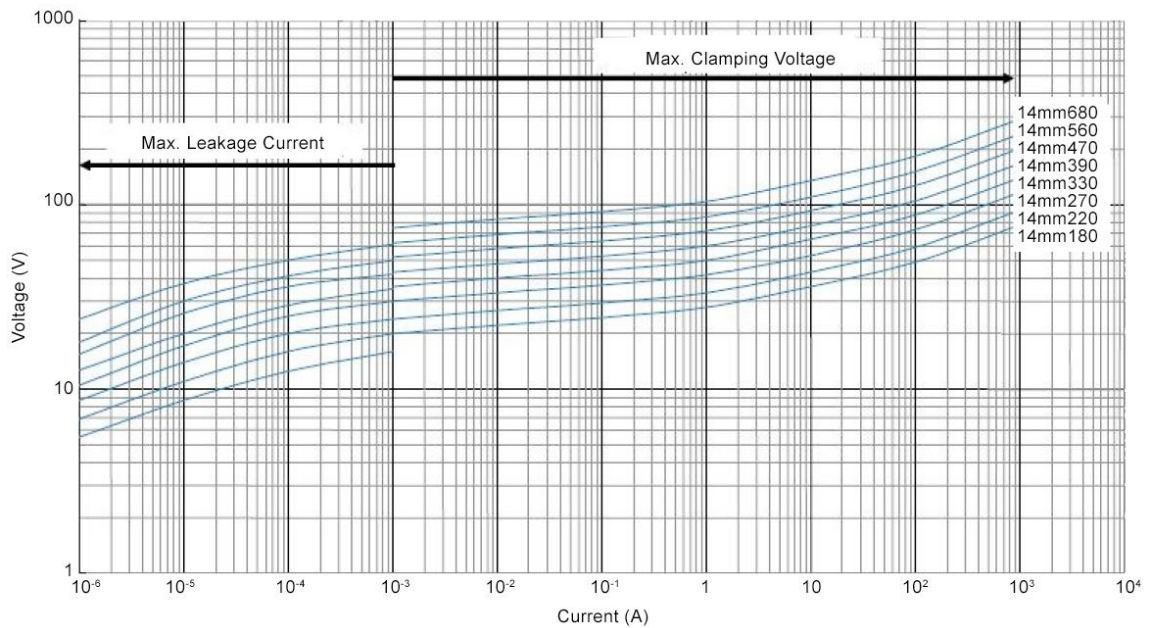

Voltage Curve – 14mm 820K-751K

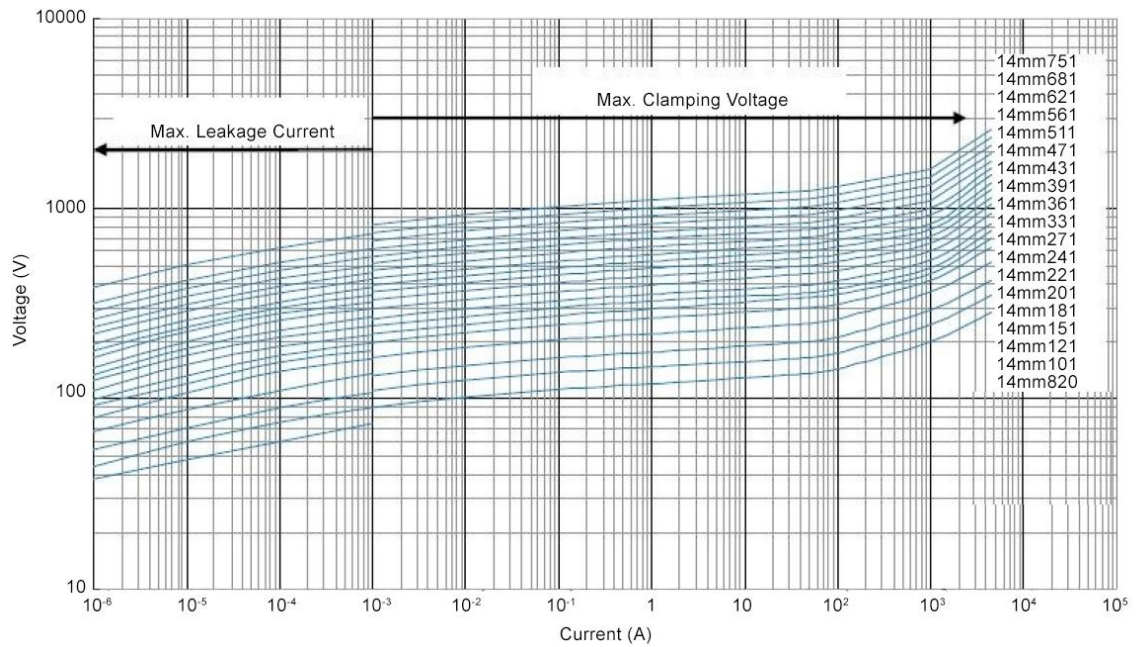

Voltage Curve – 14mm 821K-182K

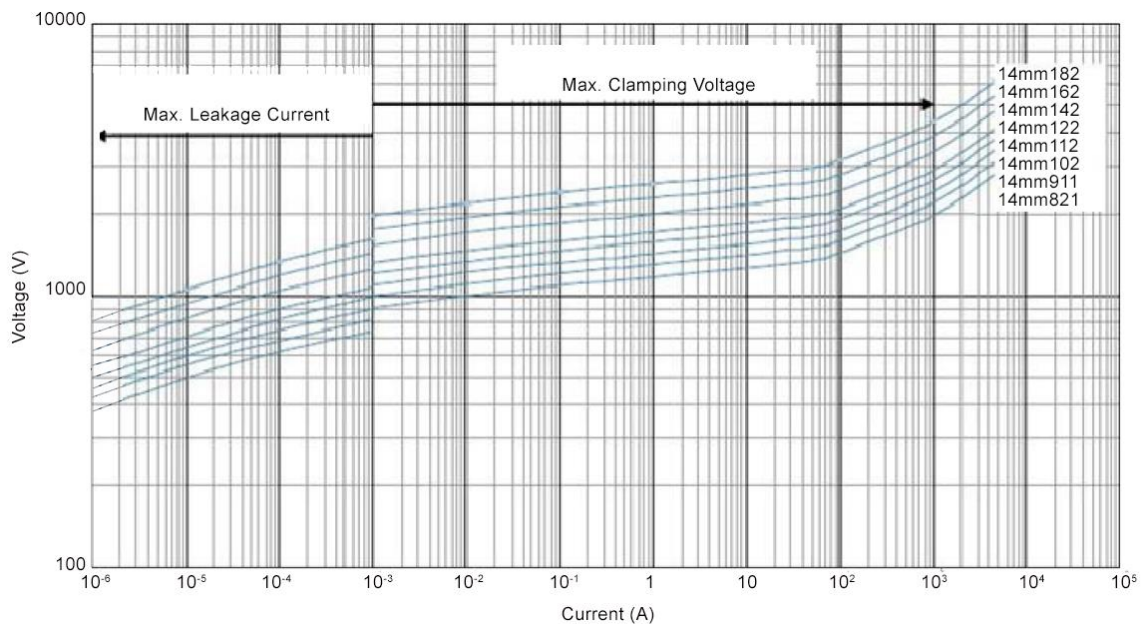

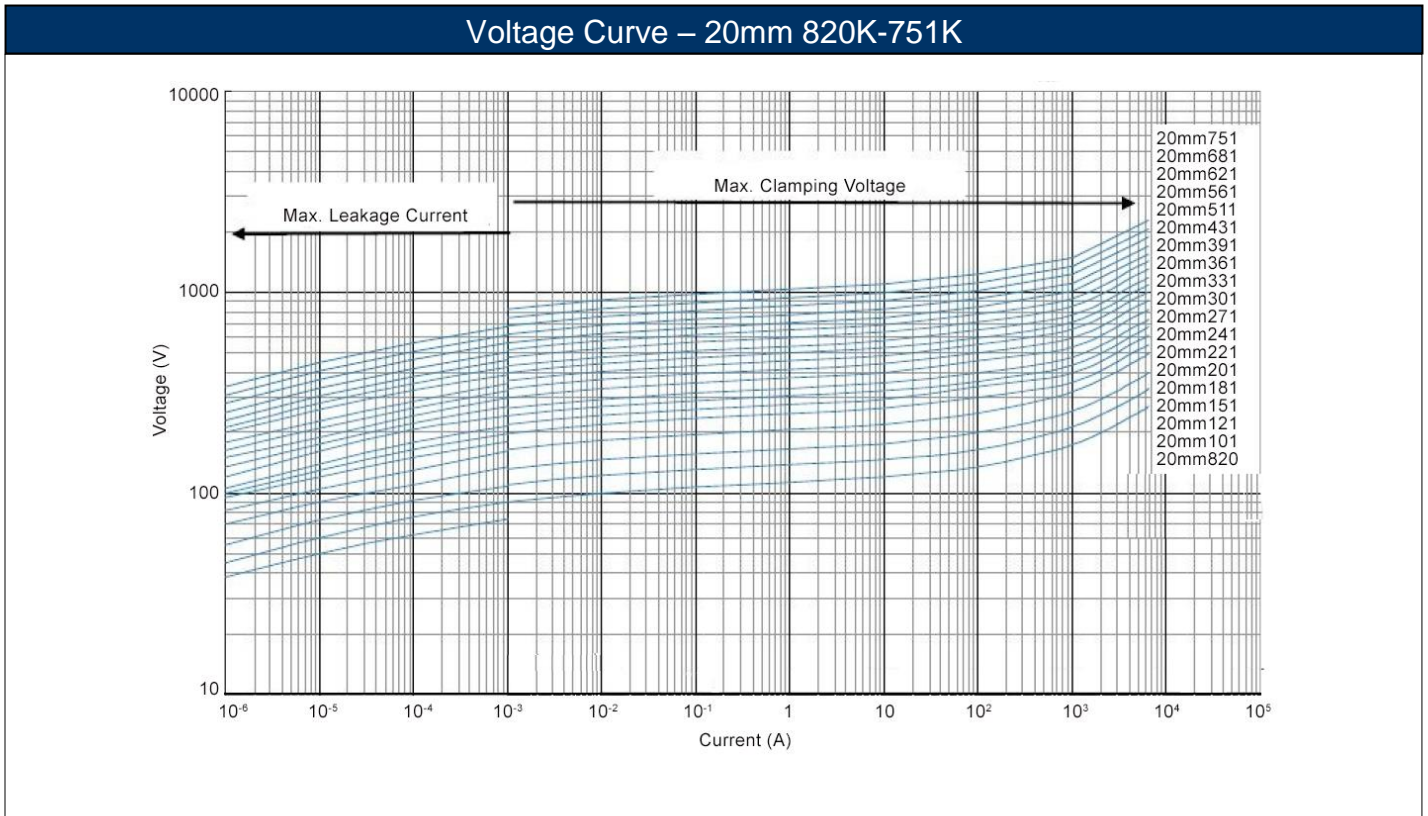
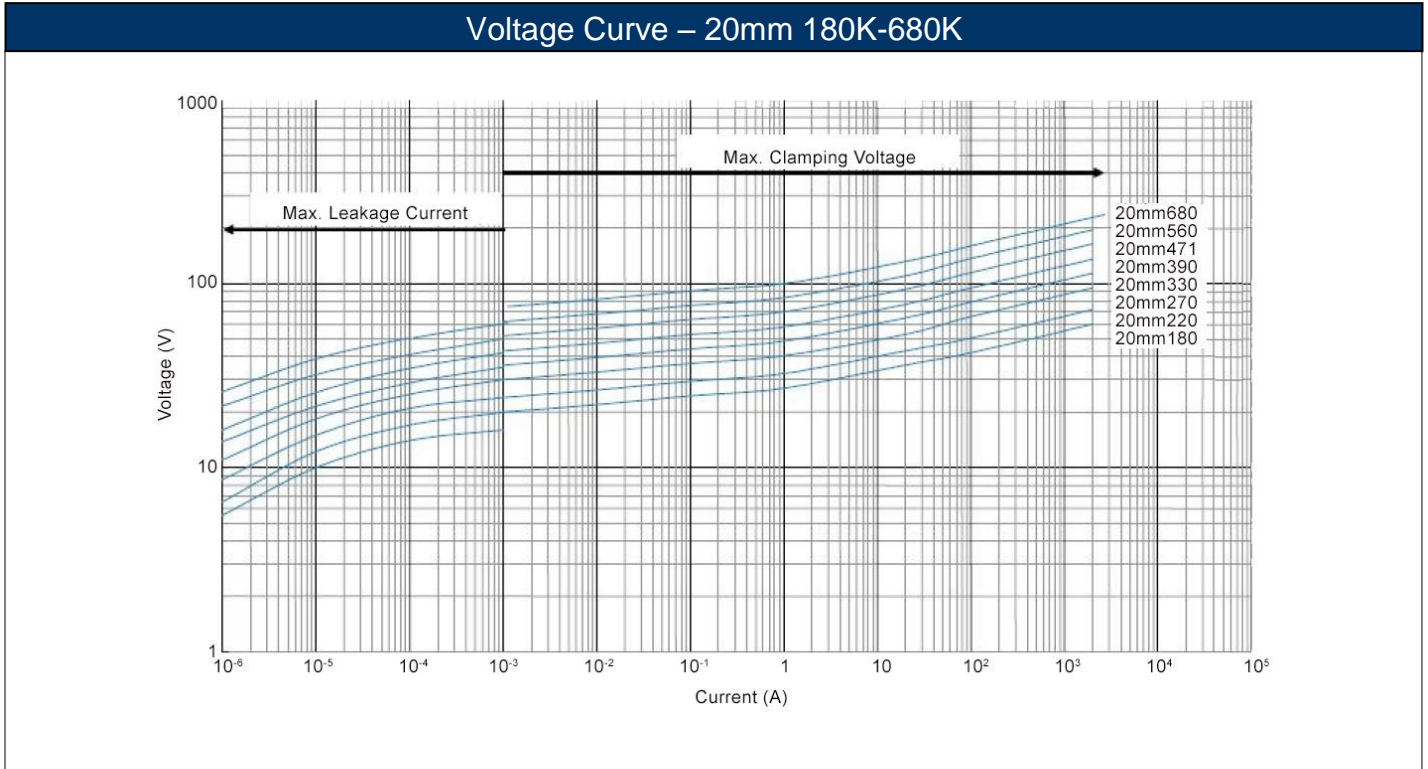

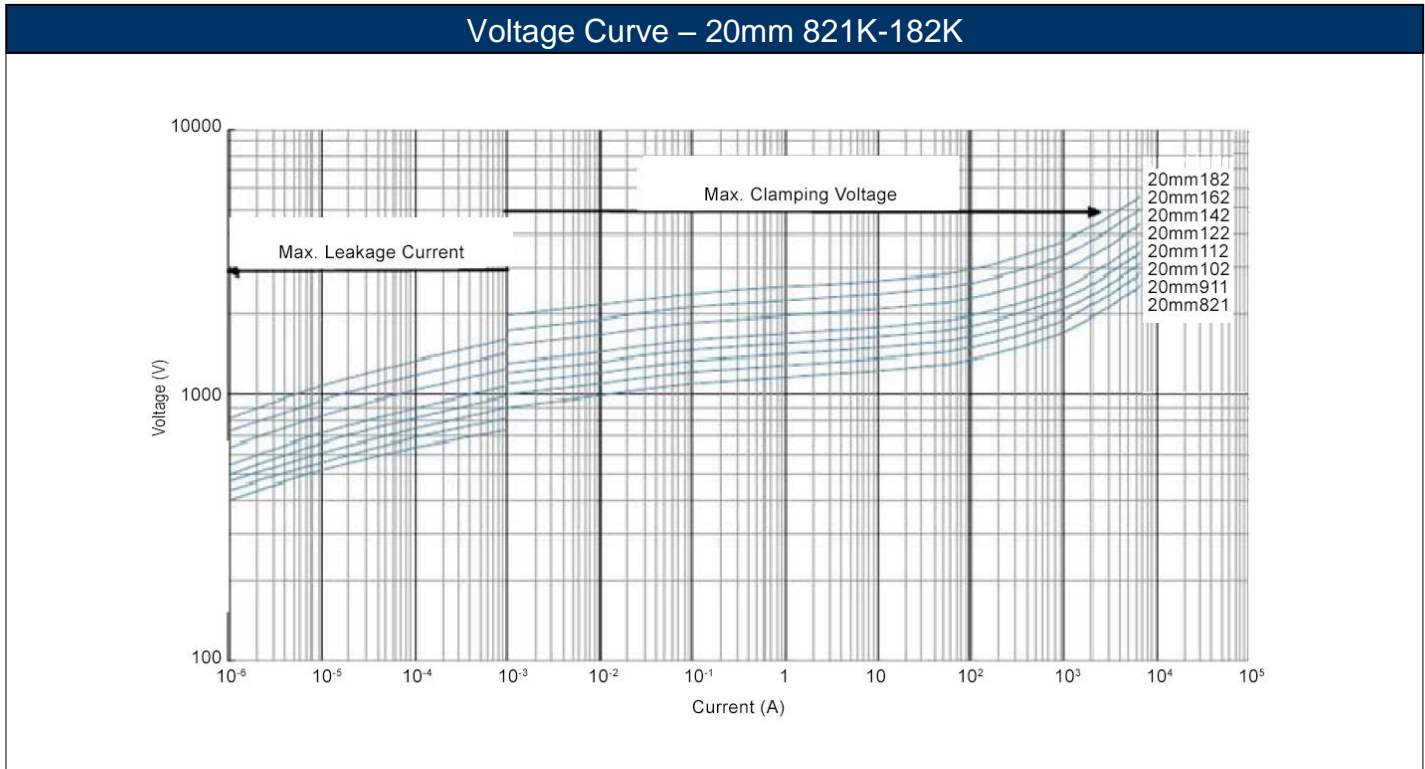

RoHS Compliance

Stackpole Electronics has joined the worldwide effort to reduce the amount of lead in electronic components and to meet the various regulatory requirements now prevalent, such as the European Union’s directive regarding “Restrictions on Hazardous Substances” (RoHS 3). As part of this ongoing program, we periodically update this document with the status regarding the availability of our compliant components. All our standard part numbers are compliant to EU Directive 2011/65/EU of the European Parliament as amended by Directive (EU) 2015/863/EU as regards the list of restricted substances.

RoHS Compliance Status						
Standard Product Series	Description	Package / Termination Type	Standard Series RoHS Compliant	Lead-Free Termination Composition	Lead-Free Mfg. Effective Date (Std Product Series)	Lead-Free Effective Date Code (YY/WW)
RV	Standard Metal Oxide Varistor	Leaded	YES	96.5/3/0.5 Sn/Ag/Cu	Always	Always

“Conflict Metals” Commitment

We at Stackpole Electronics, Inc. are joined with our industry in opposing the use of metals mined in the “conflict region” of the eastern Democratic Republic of the Congo (DRC) in our products. Recognizing that the supply chain for metals used in the electronics industry is very complex, we work closely with our own suppliers to verify to the extent possible that the materials and products we supply do not contain metals sourced from this conflict region. As such, we are in compliance with the requirements of Dodd-Frank Act regarding Conflict Minerals.

Compliance to “REACH”

We certify that all passive components supplied by Stackpole Electronics, Inc. are SVHC (Substances of Very High Concern) free and compliant with the requirements of EU Directive 1907/2006/EC, “The Registration, Evaluation, Authorization and Restriction of Chemicals”, otherwise referred to as REACH. Contact us for complete list of REACH Substance Candidate List.

Environmental Policy

It is the policy of Stackpole Electronics, Inc. (SEI) to protect the environment in all localities in which we operate. We continually strive to improve our effect on the environment. We observe all applicable laws and regulations regarding the protection of our environment and all requests related to the environment to which we have agreed. We are committed to the prevention of all forms of pollution.

How to Order

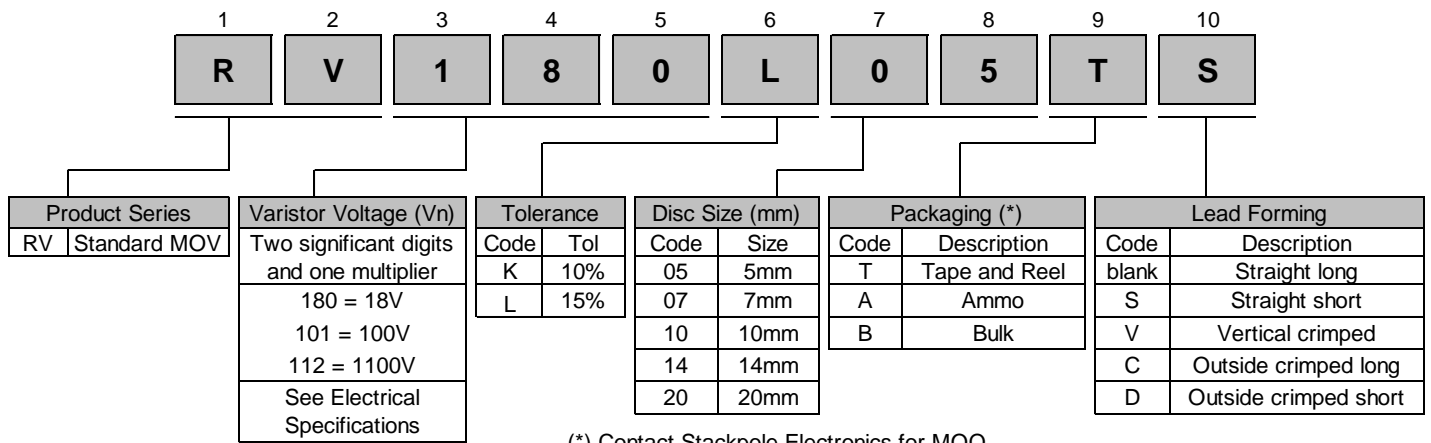

(*) Contact Stackpole Electronics for MOQ.