2 A PWM/VFM Step-down DC/DC Converter with Synchronous Rectifier for Automotive Applications

No. EC-296-210909

OUTLINE

The RP506L is a low supply current CMOS-based PWM/VFM step-down DC/DC converter with synchronous rectifier featuring 2 A⁽¹⁾ output current. Internally, a single converter consists of an oscillator, a reference voltage unit, an error amplifier, a switching control circuit, a mode control circuit, a soft start circuit, a latch type protection circuit, an under-voltage lockout (UVLO) circuit, a thermal shutdown circuit, and switching transistors.

The RP506L is employing synchronous rectification for improving the efficiency of rectification by replacing diodes with built-in switching transistors. Using synchronous rectification not only increases circuit performance but also allows a design to reduce parts count.

Power controlling method can be selected from forced PWM control type or PWM/VFM auto switching control type by inputting a signal to the MODE pin. In low output current, forced PWM control switches at fixed frequency rate in order to reduce noise. Likewise, in low output current, PWM/VFM auto switching control automatically switches from PWM mode to VFM mode in order to achieve high efficiency.

Output voltage type can be selected from an internally fixed output voltage type (RP506Lxx1G/H/K/L) or an externally adjustable output voltage type (RP506L001N/M). The output voltage accuracy of the RP506Lxx1G/H/K/L is as high as $\pm 1.5\%$ or ± 18 mV. The output voltage of the RP506L001N/M can be set by using the external resistors.

Oscillator frequency can be selected from 2.3 MHz (RP506Lxx1G/H//N) or 1.2 MHz (RP506Lxx1K/L/M). Soft-start time is Typ. 150 μ s, and by connecting an external capacitor to the TSS pin, soft-start time is adjustable.

Power good (PG) function monitors the V_{OUT} pin voltage or the feedback pin voltage (V_{FB}), and switches the PG pin to low if any abnormal condition is detected.

Protection circuits included in the RP506L are over current protection circuit, latch type protection circuit and thermal shutdown circuit. Over current protection circuit supervises the inductor peak current in each switching cycle, and if the current exceeds the I_{LXLIM} , it turns off Pch Tr. Latch type protection circuit latches the built-in driver to the OFF state and stops the operation of the step-down DC/DC converter if the over current status continues or V_{OUT} continues being the half of the setting voltage for equal or longer than protection delay time (t_{prot}). Thermal shutdown circuit detects overheating of the converter if the output pin is shorted to the ground pin (GND) etc. and stops the converter operation to protect it from damage if the junction temperature exceeds the specified temperature.

The RP506L is available in DFN3030-12 which achieves high-density mounting on boards.

⁽¹⁾ This is an approximate value. The output current is dependent on conditions and external components.

RP506L

No. EC-296-210909

FEATURES

- Input Voltage Range (Maximum Rating)2.5 V to 5.5 V (6.5 V)
- Operating Temperature Range–40°C to 105°C (RP506Lxx1x-TR-A)
–40°C to 125°C (RP506Lxx1x-TR-K)
- Supply Current.....Typ. 48 μ A (VFM mode, Lx at no load)
- Standby Current.....Typ. 0 μ A
- Output Voltage Range⁽¹⁾.....

Version	Forced PWM Control	PWM/VFM Auto Switching Control
RP506Lxx1G/H	1.1 V to 3.3 V	0.8 V to 3.3 V
RP506L001N	1.1 V to 4.0 V	0.8 V to 4.0 V
RP506Lxx1K/L		0.8 V to 3.3 V
RP506L001M		0.6 V to 4.0 V

- Output Voltage Accuracy \pm 1.5% ($V_{SET}^{(2)} \geq 1.2$ V),
 \pm 18 mV ($V_{SET} < 1.2$ V) (RP506Lxx1G/H/K/L)
- Feedback Voltage Accuracy \pm 9 mV ($V_{FB} = 0.6$ V) (RP506L001N/M)
- Output Voltage/Feedback Voltage
Temperature Coefficient \pm 100 ppm/°C
- Oscillator FrequencyTyp. 2.3 MHz (RP506Lxx1G/H//N)
.....Typ. 1.2 MHz (RP506Lxx1K/L/M)
- Oscillator Maximum DutyMin. 100%
- Built-in Driver ON Resistance.....Typ. Pch. 0.130 Ω , Nch. 0.125 Ω ($V_{IN} = 3.6$ V)
- UVLO Detector ThresholdTyp. 2.2 V
- Inductor Current Limit Circuit.....Current limit Typ. 2.8 A
- Latch Type Protection CircuitTyp. 1.5 ms
- PackageDFN3030–12

APPLICATIONS

- Power supply for accessories such as car audios, car navigation systems, and ETC systems
- Power supply for electronic control units such as EV inverter and battery charge control unit.

⁽¹⁾ Refer to *Selection Guide* for detailed information.

Fixed output voltage type (RP506Lxx1G/H/K/L) can be selected from 0.8 V, 1.0 V, 1.1 V, 1.2 V, 1.3 V, 1.5 V, 1.8 V, 1.85 V, 3.0 V and 3.3 V. Adjustable output voltage type (RP506L001N/M) can be set up to 4.0 V.

⁽²⁾ V_{SET} = Set Output Voltage

SELECTION GUIDE

The set output voltage, the output voltage type, the auto-discharge function⁽¹⁾, and the oscillator frequency for the ICs are user-selectable options.

Selection Guide

Product Name	Package	Quantity per Reel	Pb Free	Halogen Free
RP506Lxx1\$-TR-#	DFN3030-12	3,000 pcs	Yes	Yes

xx: Designation of the set output voltage (V_{SET})⁽²⁾

For Fixed Output Voltage Type⁽³⁾: 0.8 V, 1.0 V, 1.1 V, 1.2 V, 1.3 V, 1.5 V, 1.8 V, 1.85 V, 3.0 V, 3.3 V

For Adjustable Output Voltage Type: 00 only

\$: Designation of Version

Version	Output Voltage Type	Auto-discharge Function	Oscillator Frequency	V_{SET}	
				Forced PWM	PWM/VFM Auto Switching
RP506Lxx1G	Fixed	No	2.3 MHz	1.1 V to 3.3 V	0.8 V to 3.3 V
RP506Lxx1H		Yes			
RP506L001N	Adjustable	No	1.2 MHz	1.1 V to 4.0 V	0.8 V to 4.0 V
RP506Lxx1K	Fixed				
RP506Lxx1L			Yes		0.8 V to 3.3 V
RP506L001M	Adjustable	No		0.6 V to 4.0 V	

#: Quality Class

#	Operating Temperature Range	Test Temperature
A	-40°C to 105°C	25°C, High
K	-40°C to 125°C	Low, 25°C, High

⁽¹⁾ Auto-discharge function quickly lowers the output voltage to 0 V, when the chip enable signal is switched from the active mode to the standby mode, by releasing the electrical charge accumulated in the external capacitor.

⁽²⁾ V_{SET} can be set only within the specified range of voltage. Refer to *Designation of Version* for detailed information.

⁽³⁾ 0.05 V step is also available as a custom code.

RP506L

No. EC-296-210909

BLOCK DIAGRAMS

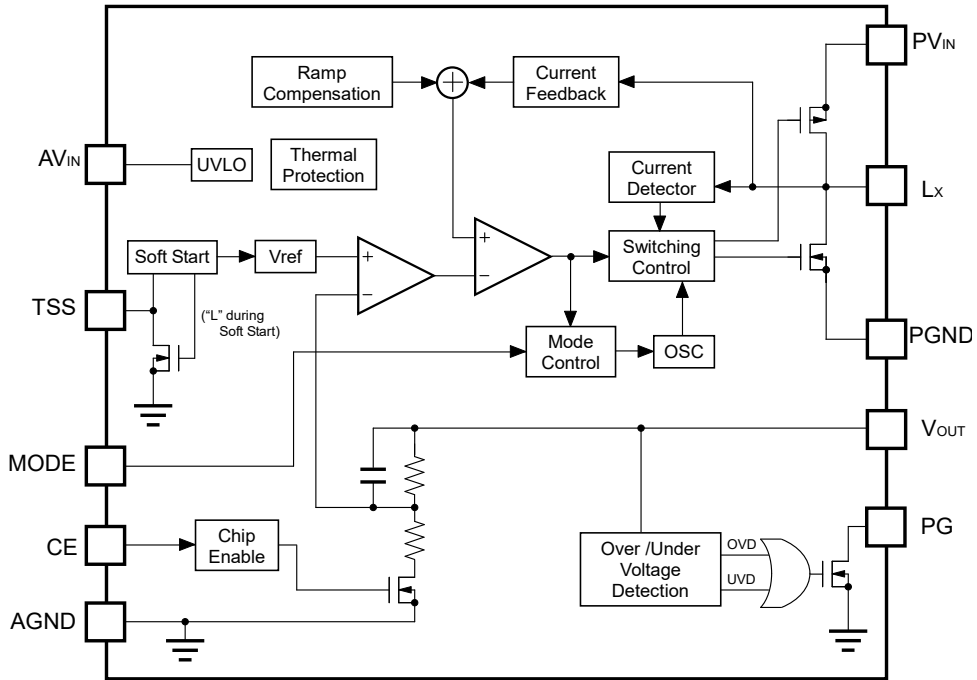

RP506Lxx1G/K Block Diagram

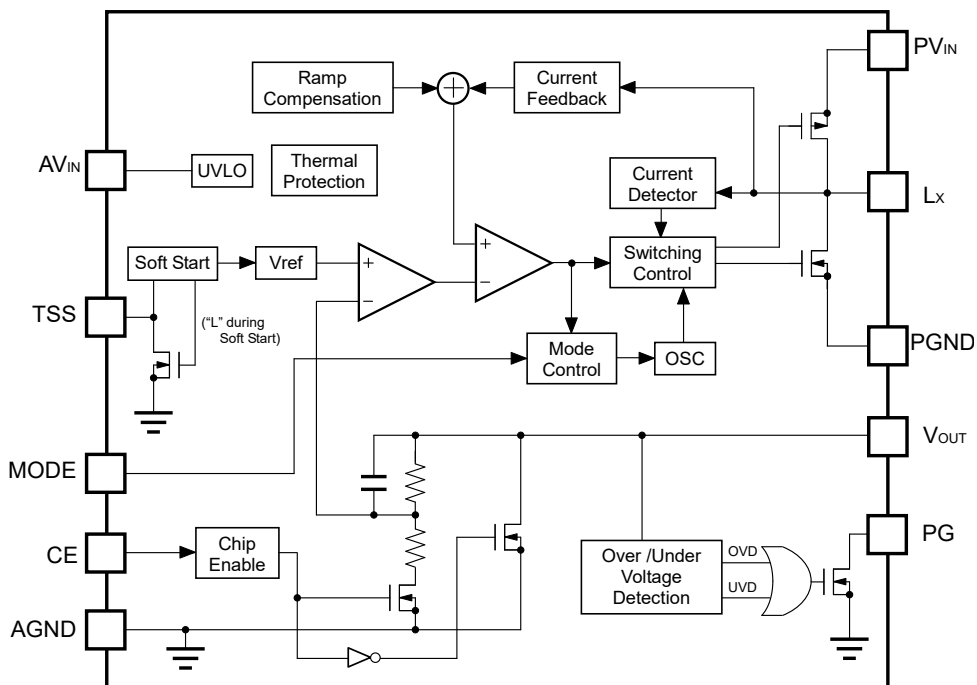

RP506Lxx1H/L Block Diagram

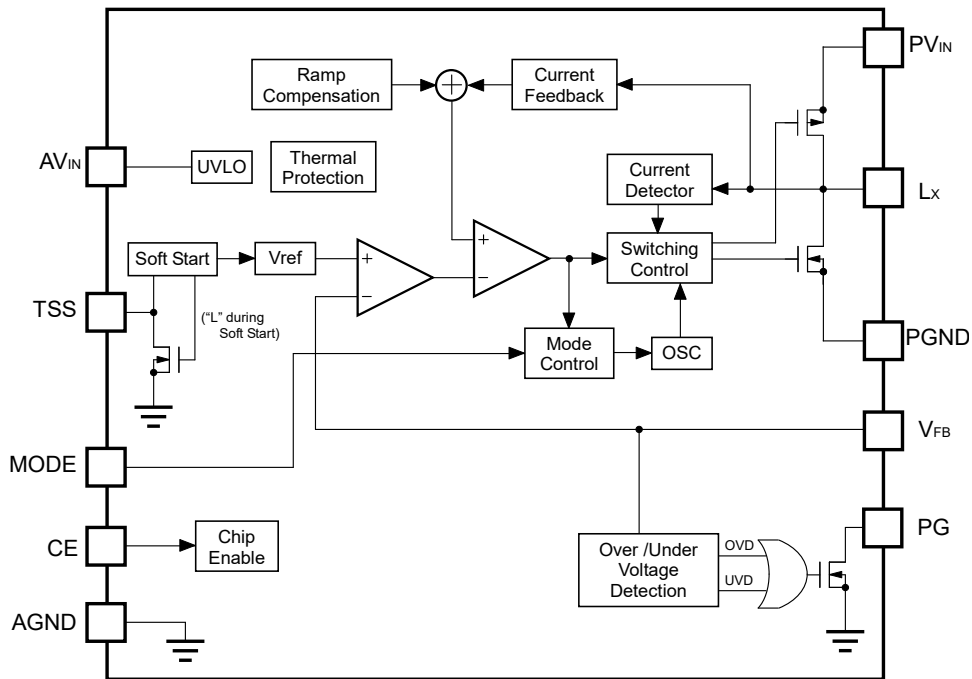

RP506L001N/M Block Diagram

RP506L

No. EC-296-210909

PIN DESCRIPTIONS

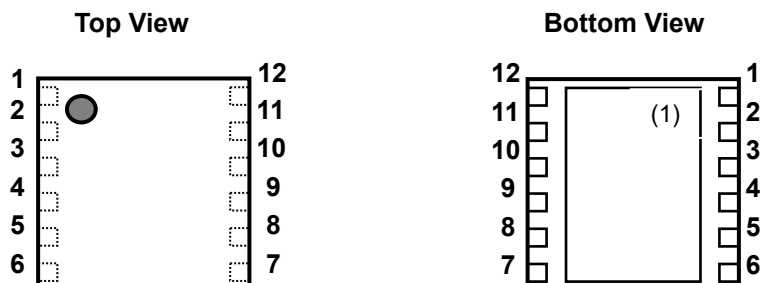

DFN3030-12 Pin Configurations

DFN3030-12 Pin Descriptions

Pin No.	Symbol	Description
1	PV _{IN}	PV _{IN} Input Voltage Pin ⁽²⁾
2	PV _{IN}	PV _{IN} Input Voltage Pin ⁽²⁾
3	AV _{IN}	AV _{IN} Input Voltage Pin ⁽²⁾
4	PG	Power Good Pin
5	CE	Chip Enable Pin (Active "H")
6	MODE	Mode Control Pin ("H": forced PWM control, "L": PWM/VFM auto switching control)
7	TSS	Soft-start Pin
8	V _{OUT} / V _{FB}	Output/ Feedback Voltage Pin
9	AGND	Analog Ground Pin ⁽³⁾
10	L _x	Switching Pin
11	NC	No Connection
12	PGND	Power Ground Pin ⁽³⁾

⁽¹⁾ The tab on the bottom of the package enhances thermal performance and is electrically connected to GND (substrate level). It is recommended that the tab be connected to the ground plane on the board, or otherwise be left floating.

⁽²⁾ No.1 pin, No.2 pin and No.3 pin must be wired to the V_{IN} plane when mounting on boards.

⁽³⁾ No.9 pin and No.12 pin must be wired to the GND plane when mounting on boards.

ABSOLUTE MAXIMUM RATINGS

Absolute Maximum Ratings

(AGND = PGND = 0 V)

Symbol	Item		Rating	Unit
V_{IN}	A/PV _{IN} Pin Voltage		-0.3 to 6.5	V
V_{LX}	L _x Pin Voltage		-0.3 to A/PV _{IN} +0.3	V
V_{CE}	CE Pin Voltage		-0.3 to 6.5	V
V_{OUT}/V_{FB}	V _{OUT} /V _{FB} Pin Voltage		-0.3 to 6.5	V
V_{MODE}	MODE Pin Voltage		-0.3 to 6.5	V
V_{PG}	PG Pin Voltage		-0.3 to 6.5	V
V_{TSS}	TSS Pin Voltage		-0.3 to AV _{IN} +0.3	V
I_{LX}	L _x Pin Output Current		2.8	A
P_D	Power Dissipation ⁽¹⁾	DFN3030-12 JEDEC STD. 51-7 Test Land Pattern	4300	mW
T_j	Junction Temperature Range		-40 to 150	°C
T_{stg}	Storage Temperature Range		-55 to 150	°C

ABSOLUTE MAXIMUM RATINGS

Electronic and mechanical stress momentarily exceeded absolute maximum ratings may cause the permanent damages and may degrade the lifetime and safety for both device and system using the device in the field. The functional operation at or over these absolute maximum ratings is not assured.

RECOMMENDED OPERATING CONDITIONS

Recommended Operating Conditions

Symbol	Item		Rating	Unit
V_{IN}	Input Voltage		2.5 to 5.5	V
T_a	Operating Temperature Range	RP506Lxx1x-TR-A	-40 to 105	°C
		RP506Lxx1x-TR-K	-40 to 125	°C

RECOMMENDED OPERATING CONDITIONS

All of electronic equipment should be designed that the mounted semiconductor devices operate within the recommended operating conditions. The semiconductor devices cannot operate normally over the recommended operating conditions, even if when they are used over such conditions by momentary electronic noise or surge. And the semiconductor devices may receive serious damage when they continue to operate over the recommended operating conditions.

⁽¹⁾ Refer to *POWER DISSIPATION* for detailed information.

RP506L

No. EC-296-210909

ELECTRICAL CHARACTERISTICS

RP506Lxx1x-TR-A

The specifications surrounded by are guaranteed by design engineering at $-40^{\circ}\text{C} \leq T_a \leq 105^{\circ}\text{C}$.

RP506Lxx1 Electrical Characteristics

($T_a = 25^{\circ}\text{C}$)

Symbol	Item	Conditions	Min.	Typ.	Max.	Unit
Istandby	Standby Current	$A/PV_{IN} = 5.5\text{ V}, V_{CE} = 0\text{ V}$		0	5	μA
I_{CEH}	CE "H" Input Current	$A/PV_{IN} = V_{CE} = 5.5\text{ V}$	-1	0	1	μA
I_{CEL}	CE "L" Input Current	$A/PV_{IN} = 5.5\text{ V}, V_{CE} = 0\text{ V}$	-1	0	1	μA
I_{MODEH}	MODE "H" Input Current	$A/PV_{IN} = V_{MODE} = 5.5\text{ V}, V_{CE} = 0\text{ V}$	-1	0	1	μA
I_{MODEL}	MODE "L" Input Current	$A/PV_{IN} = 5.5\text{ V}, V_{CE} = V_{MODE} = 0\text{ V}$	-1	0	1	μA
$I_{LXLEAKH}$	LX Leakage Current "H"	$A/PV_{IN} = V_{LX} = 5.5\text{ V}, V_{CE} = 0\text{ V}$	-1	0	6	μA
$I_{LXLEAKL}$	LX Leakage Current "L"	$A/PV_{IN} = 5.5\text{ V}, V_{CE} = V_{LX} = 0\text{ V}$	-15	0	1	μA
V_{CEH}	CE "H" Input Voltage	$A/PV_{IN} = 5.5\text{ V}$	1.0			V
V_{CEL}	CE "L" Input Voltage	$A/PV_{IN} = 2.5\text{ V}$			0.4	V
V_{MODEH}	MODE "H" Input Voltage	$A/PV_{IN} = 5.5\text{ V}$	1.0			V
V_{MODEL}	MODE "L" Input Voltage	$A/PV_{IN} = 2.5\text{ V}$			0.4	V
R_{ONP}	On Resistance of Pch Transistor	$A/PV_{IN} = 3.6\text{ V}, I_{LX} = -100\text{ mA}$		0.130		Ω
R_{ONN}	On Resistance of Nch Transistor	$A/PV_{IN} = 3.6\text{ V}, I_{LX} = -100\text{ mA}$		0.125		Ω
Maxduty	Maximum Duty Cycle		100			%
tstart1	Soft-start Time 1	$A/PV_{IN} = V_{CE} = 3.6\text{ V}$ or $V_{SET} + 1\text{ V}$, TSS = OPEN	75	150	300	μs
tstart2	Soft-start Time 2	$A/PV_{IN} = V_{CE} = 3.6\text{ V}$ or $V_{SET} + 1\text{ V}$, $C_{SS} = 0.1\text{ }\mu\text{F}$	15	30	45	ms
I_{LXLIM}	LX Current Limit	$A/PV_{IN} = V_{CE} = 3.6\text{ V}$ or $V_{SET} + 1\text{ V}$	2200	2800		mA
tprot	Protection Delay Time	$A/PV_{IN} = V_{CE} = 3.6\text{ V}$ or $V_{SET} + 1\text{ V}$	0.5	1.5	5	ms
V_{UVLO1}	UVLO Detector Threshold	$A/PV_{IN} = V_{CE}$	2.1	2.2	2.3	V
V_{UVLO2}	UVLO Released Voltage	$A/PV_{IN} = V_{CE}$	2.2	2.3	2.4	V
T_{TSD}	Thermal Shutdown Temperature	Junction Temperature		165		$^{\circ}\text{C}$
T_{TSR}	Thermal Shutdown Released Temperature	Junction Temperature		115		$^{\circ}\text{C}$
R_{PG}	On Resistance of PG Pin When Low Output	$A/PV_{IN} = 3.6\text{ V}$, $V_{OUT} = 0\text{ V}$ or $V_{FB} = 0\text{ V}$		45		Ω

All test items listed under Electrical Characteristics are done under the pulse load condition ($T_j \approx T_a = 25^{\circ}\text{C}$).

ELECTRICAL CHARACTERISTICS (continued)

RP506Lxx1x-TR-A

The specifications surrounded by are guaranteed by design engineering at $-40^{\circ}\text{C} \leq T_a \leq 105^{\circ}\text{C}$.

RP506Lxx1G/H, RP506L001N (Oscillator Frequency: 2.3 MHz) Electrical Characteristics (Ta = 25°C)

Symbol	Item	Conditions	Min.	Typ.	Max.	Unit
V_{IN}	When MODE = H Operating Input Voltage ⁽¹⁾	$1.1\text{ V} \leq V_{\text{SET}} < 1.2\text{ V}$	2.5		4.5	V
		$1.2\text{ V} \leq V_{\text{SET}}$	2.5		5.5	
	When MODE = L Operating Input Voltage ⁽²⁾	$0.8\text{ V} \leq V_{\text{SET}} < 1.0\text{ V}$	2.5		4.5	
		$1.0\text{ V} \leq V_{\text{SET}}$	2.5		5.5	
fosc	Oscillator Frequency	$A/PV_{\text{IN}} = V_{\text{CE}} = 3.6\text{ V}$ or $V_{\text{SET}} + 1\text{ V}$	2.00	2.3	2.50	MHz

RP506Lxx1K/L, RP506L001M (Oscillator Frequency: 1.2 MHz) Electrical Characteristics

V_{IN}	When MODE = H Operating Input Voltage	$0.6\text{ V} \leq V_{\text{SET}} < 0.7\text{ V}$	2.5		4.5	V
		$0.7\text{ V} \leq V_{\text{SET}}$	2.5		5.5	
	When MODE = L Operating Input Voltage	$0.6\text{ V} \leq V_{\text{SET}}$	2.5		5.5	
fosc	Oscillator Frequency	$A/PV_{\text{IN}} = V_{\text{CE}} = 3.6\text{ V}$ or $V_{\text{SET}} + 1\text{ V}$	1.00	1.20	1.40	MHz

All test items listed under *Electrical Characteristics* are done under the pulse load condition ($T_j \approx T_a = 25^{\circ}\text{C}$).

⁽¹⁾ As for RP506Lxx1G/H//N (MODE = H), V_{SET} can be set from 1.1 V.

⁽²⁾ As for RP506Lxx1G/H//N (MODE = L), V_{SET} can be set from 0.8 V.

RP506L

No. EC-296-210909

ELECTRICAL CHARACTERISTICS (continued)

RP506Lxx1x-TR-A

The specifications surrounded by \square are guaranteed by design engineering at $-40^{\circ}\text{C} \leq T_a \leq 105^{\circ}\text{C}$.

RP506Lxx1G/H/K/L (Fixed Output Voltage Type) Electrical Characteristics

($T_a = 25^{\circ}\text{C}$)

Symbol	Item	Conditions	Min.	Typ.	Max.	Unit		
V_{OUT}	Output Voltage	$A/PV_{\text{IN}} = V_{\text{CE}} = 3.6 \text{ V}$ or $V_{\text{SET}} + 1 \text{ V}$	$V_{\text{SET}} \geq 1.2 \text{ V}$	x0.985		x1.015	V	
				\square x0.975		\square x1.025		
			$V_{\text{SET}} < 1.2 \text{ V}$			0.018		
				\square -0.018		\square 0.03		
I_{DD1}	Supply Current 1	$A/PV_{\text{IN}} = V_{\text{CE}} = 5.5 \text{ V}, V_{\text{OUT}} = V_{\text{SET}} \times 0.8$		600		μA		
I_{DD2}	Supply Current 2	$A/PV_{\text{IN}} = V_{\text{CE}} = V_{\text{OUT}} = 5.5 \text{ V}$	$V_{\text{MODE}} = 0 \text{ V}$		48	\square 72	μA	
			$V_{\text{MODE}} = 5.5 \text{ V}$		600		μA	
I_{VOUTL}	V_{OUT} "L" Current	$A/PV_{\text{IN}} = 5.5 \text{ V}, V_{\text{CE}} = V_{\text{OUT}} = 0 \text{ V}$	\square -1	0	\square 1	μA		
V_{OVD}	OVD Voltage	$A/PV_{\text{IN}} = 3.6 \text{ V}$		$V_{\text{SET}} \times 1.2$		V		
V_{UVD}	UVD Voltage	$A/PV_{\text{IN}} = 3.6 \text{ V}$		$V_{\text{SET}} \times 0.8$		V		

RP506Lxx1G/K (Fixed Output Voltage Type without Auto-discharge Function)

I_{VOUTH}	V_{OUT} "H" Current	$A/PV_{\text{IN}} = V_{\text{OUT}} = 5.5 \text{ V}, V_{\text{CE}} = 0 \text{ V}$	\square -1	0	\square 1	μA
--------------------	------------------------------	--	--------------	---	-------------	---------------

RP506Lxx1H/L (Fixed Output Voltage Type with Auto-discharge Function)

R_{LOW}	On Resistance of Low Output	$A/PV_{\text{IN}} = 3.6 \text{ V}, V_{\text{CE}} = 0 \text{ V}$		45		Ω
------------------	-----------------------------	---	--	----	--	----------

RP506L001N/M (Adjustable Output Voltage Type) Electrical Characteristics

V_{FB}	Feedback Voltage	$A/PV_{\text{IN}} = V_{\text{CE}} = 3.6 \text{ V}$	0.591	0.600	0.609	V	
			\square 0.585	0.600	\square 0.615		
$\Delta V_{\text{FB}} / \Delta T_a$	Feedback Voltage Temperature Coefficient	$-40^{\circ}\text{C} \leq T_a \leq 105^{\circ}\text{C}$		± 100		ppm/ $^{\circ}\text{C}$	
I_{DD1}	Supply Current 1	$A/PV_{\text{IN}} = V_{\text{CE}} = 5.5 \text{ V}, V_{\text{FB}} = 0.48 \text{ V}$		600		μA	
I_{DD2}	Supply Current 2	$A/PV_{\text{IN}} = V_{\text{CE}} = V_{\text{FB}} = 5.5 \text{ V}$	$V_{\text{MODE}} = 0 \text{ V}$		48	\square 72	μA
			$V_{\text{MODE}} = 5.5 \text{ V}$		600		μA
I_{VFBH}	V_{FB} "H" Current	$A/PV_{\text{IN}} = V_{\text{FB}} = 5.5 \text{ V}, V_{\text{CE}} = 0 \text{ V}$	\square -1	0	\square 1	μA	
I_{VLBL}	V_{FB} "L" Current	$A/PV_{\text{IN}} = 5.5 \text{ V}, V_{\text{CE}} = V_{\text{FB}} = 0 \text{ V}$	\square -1	0	\square 1	μA	
V_{OVD}	OVD Voltage	$A/PV_{\text{IN}} = 3.6 \text{ V}$		0.72		V	
V_{UVD}	UVD Voltage	$A/PV_{\text{IN}} = 3.6 \text{ V}$		0.48		V	

All test items listed under Electrical Characteristics are done under the pulse load condition ($T_j \approx T_a = 25^{\circ}\text{C}$) except Feedback Voltage Temperature Coefficient.

ELECTRICAL CHARACTERISTICS (continued)

RP506Lxx1x-TR-A

The specifications surrounded by are guaranteed by design engineering at $-40^{\circ}\text{C} \leq T_a \leq 105^{\circ}\text{C}$.

RP506L Electrical Characteristics by Different Output Voltage (Ta = 25°C)

Product Name	V _{OUT} [V] (Ta = 25°C)			V _{OUT} [V] (Ta = -40 ~ 105°C)		
	Min.	Typ.	Max.	Min.	Typ.	Max.
RP506L081x	0.782	0.800	0.818	0.770	0.800	0.830
RP506L101x	0.982	1.000	1.018	0.970	1.000	1.030
RP506L111x	1.082	1.100	1.118	1.070	1.100	1.130
RP506L121x	1.182	1.200	1.218	1.170	1.200	1.230
RP506L131x	1.281	1.300	1.319	1.268	1.300	1.332
RP506L151x	1.478	1.500	1.522	1.463	1.500	1.537
RP506L181x	1.773	1.800	1.827	1.755	1.800	1.845
RP506L181x5	1.823	1.850	1.877	1.804	1.850	1.896
RP506L301x	2.955	3.000	3.045	2.925	3.000	3.075
RP506L331x	3.251	3.300	3.349	3.218	3.300	3.382

RP506L

No. EC-296-210909

ELECTRICAL CHARACTERISTICS (continued)**RP506Lxx1x-TR-K****RP506Lxx1 Electrical Characteristics**($-40^{\circ}\text{C} \leq T_a \leq 125^{\circ}\text{C}$)

Symbol	Item	Conditions	Min.	Typ.	Max.	Unit
Istandby	Standby Current	$A/PV_{IN} = 5.5\text{ V}, V_{CE} = 0\text{ V}$		0	10	μA
I_{CEH}	CE "H" Input Current	$A/PV_{IN} = V_{CE} = 5.5\text{ V}$	-1	0	1	μA
I_{CEL}	CE "L" Input Current	$A/PV_{IN} = 5.5\text{ V}, V_{CE} = 0\text{ V}$	-1	0	1	μA
I_{MODEH}	MODE "H" Input Current	$A/PV_{IN} = V_{MODE} = 5.5\text{ V}, V_{CE} = 0\text{ V}$	-1	0	1	μA
I_{MODEL}	MODE "L" Input Current	$A/PV_{IN} = 5.5\text{ V}, V_{CE} = V_{MODE} = 0\text{ V}$	-1	0	1	μA
$I_{LXLEAKH}$	LX Leakage Current "H"	$A/PV_{IN} = V_{LX} = 5.5\text{ V}, V_{CE} = 0\text{ V}$	-1	0	6	μA
$I_{LXLEAKL}$	LX Leakage Current "L"	$A/PV_{IN} = 5.5\text{ V}, V_{CE} = V_{LX} = 0\text{ V}$	-40	0	1	μA
V_{CEH}	CE "H" Input Voltage	$A/PV_{IN} = 5.5\text{ V}$	1.0			V
V_{CEL}	CE "L" Input Voltage	$A/PV_{IN} = 2.5\text{ V}$			0.4	V
V_{MODEH}	MODE "H" Input Voltage	$A/PV_{IN} = 5.5\text{ V}$	1.0			V
V_{MODEL}	MODE "L" Input Voltage	$A/PV_{IN} = 2.5\text{ V}$			0.4	V
R_{ONP}	On Resistance of Pch Transistor	$A/PV_{IN} = 3.6\text{ V}, I_{LX} = -100\text{ mA}$		0.130		Ω
R_{ONN}	On Resistance of Nch Transistor	$A/PV_{IN} = 3.6\text{ V}, I_{LX} = -100\text{ mA}$		0.125		Ω
Maxduty	Maximum Duty Cycle		100			%
tstart1	Soft-start Time 1	$A/PV_{IN} = V_{CE} = 3.6\text{ V}$ or $V_{SET} + 1\text{ V}$, TSS = OPEN	75	150	300	μs
tstart2	Soft-start Time 2	$A/PV_{IN} = V_{CE} = 3.6\text{ V}$ or $V_{SET} + 1\text{ V}$, $C_{SS} = 0.1\text{ }\mu\text{F}$	15	30	45	ms
I_{LXLIM}	LX Current Limit	$A/PV_{IN} = V_{CE} = 3.6\text{ V}$ or $V_{SET} + 1\text{ V}$	2000	2800		mA
tprot	Protection Delay Time	$A/PV_{IN} = V_{CE} = 3.6\text{ V}$ or $V_{SET} + 1\text{ V}$	0.5	1.5	5	ms
V_{UVLO1}	UVLO Detector Threshold	$A/PV_{IN} = V_{CE}$	2.1	2.2	2.3	V
V_{UVLO2}	UVLO Released Voltage	$A/PV_{IN} = V_{CE}$	2.2	2.3	2.4	V
T_{TSD}	Thermal Shutdown Temperature	Junction Temperature		165		$^{\circ}\text{C}$
T_{TSR}	Thermal Shutdown Released Temperature	Junction Temperature		115		$^{\circ}\text{C}$
R_{PG}	On Resistance of PG Pin When Low Output	$A/PV_{IN} = 3.6\text{ V}$, $V_{OUT} = 0\text{ V}$ or $V_{FB} = 0\text{ V}$		45		Ω

ELECTRICAL CHARACTERISTICS (continued)

RP506Lxx1x-TR-K

RP506Lxx1G/H, RP506L001N (Oscillator Frequency: 2.3 MHz) Electrical Characteristics (−40°C ≤ Ta ≤ 125°C)

Symbol	Item	Conditions	Min.	Typ.	Max.	Unit
V _{IN}	When MODE = H Operating Input Voltage ⁽¹⁾	1.1 V ≤ V _{SET} < 1.2 V	2.5		4.5	V
		1.2 V ≤ V _{SET}	2.5		5.5	
	When MODE = L Operating Input Voltage ⁽²⁾	0.8 V ≤ V _{SET} < 1.0 V	2.5		4.5	
		1.0 V ≤ V _{SET}	2.5		5.5	
fosc	Oscillator Frequency	A/PV _{IN} = V _{CE} = 3.6 V or V _{SET} + 1 V	2.00	2.3	2.50	MHz

RP506Lxx1K/L, RP506L001M (Oscillator Frequency: 1.2 MHz) Electrical Characteristics

V _{IN}	When MODE = H Operating Input Voltage	0.6 V ≤ V _{SET} < 0.7 V	2.5		4.5	V
		0.7 V ≤ V _{SET}	2.5		5.5	
	When MODE = L Operating Input Voltage	0.6 V ≤ V _{SET}	2.5		5.5	
fosc	Oscillator Frequency	A/PV _{IN} = V _{CE} = 3.6 V or V _{SET} + 1 V	1.00	1.20	1.40	MHz

⁽¹⁾ As for RP506Lxx1G/H//N (MODE = H), V_{SET} can be set from 1.1 V.

⁽²⁾ As for RP506Lxx1G/H//N (MODE = L), V_{SET} can be set from 0.8 V.

RP506L

No. EC-296-210909

ELECTRICAL CHARACTERISTICS (continued)**RP506Lxx1x-TR-K****RP506Lxx1G/H/K/L (Fixed Output Voltage Type) Electrical Characteristics** (−40°C ≤ Ta ≤ 125°C)

Symbol	Item	Conditions		Min.	Typ.	Max.	Unit
V _{OUT}	Output Voltage	A/PV _{IN} = V _{CE} = 3.6 V	V _{SET} ≥ 1.2 V	Ta = 25°C	x0.985	x1.015	V
				−40°C ≤ Ta ≤ 125°C	x0.975	x1.025	
		or V _{SET} + 1 V	V _{SET} < 1.2 V	Ta = 25°C	−0.018	0.018	
				−40°C ≤ Ta ≤ 125°C	−0.03	0.03	
I _{DD1}	Supply Current 1	A/PV _{IN} = V _{CE} = 5.5 V, V _{OUT} = V _{SET} × 0.8			600		μA
I _{DD2}	Supply Current 2	A/PV _{IN} = V _{CE} = V _{OUT} = 5.5 V	V _{MODE} = 0 V		48	72	μA
			V _{MODE} = 5.5 V		600		μA
I _{VOU_TL}	V _{OUT} “L” Current	A/PV _{IN} = 5.5 V, V _{CE} = V _{OUT} = 0 V		−1	0	1	μA
V _{OVD}	OVD Voltage	A/PV _{IN} = 3.6 V			V _{SET} × 1.2		V
V _{UVD}	UVD Voltage	A/PV _{IN} = 3.6 V			V _{SET} × 0.8		V

RP506Lxx1G/K (Fixed Output Voltage Type without Auto-discharge Function)

I _{VOU_TH}	V _{OUT} “H” Current	A/PV _{IN} = V _{OUT} = 5.5 V, V _{CE} = 0 V		−1	0	1	μA
-------------------------------	------------------------------	--	--	----	---	---	----

RP506Lxx1H/L (Fixed Output Voltage Type with Auto-discharge Function)

R _{LOW}	On Resistance of Low Output	A/PV _{IN} = 3.6 V, V _{CE} = 0 V			45		Ω
------------------	-----------------------------	---	--	--	----	--	---

RP506L001N/M (Adjustable Output Voltage Type) Electrical Characteristics

V _{FB}	Feedback Voltage	A/PV _{IN} = V _{CE} = 3.6 V	Ta = 25°C	0.591	0.600	0.609	V
			−40°C ≤ Ta ≤ 125°C	0.585		0.615	
I _{DD1}	Supply Current 1	A/PV _{IN} = V _{CE} = 5.5 V, V _{FB} = 0.48 V			600		μA
I _{DD2}	Supply Current 2	A/PV _{IN} = V _{CE} = V _{FB} = 5.5 V	V _{MODE} = 0 V		48	72	μA
			V _{MODE} = 5.5 V		600		μA
I _{VFBH}	V _{FB} “H” Current	A/PV _{IN} = V _{FB} = 5.5 V, V _{CE} = 0 V		−1	0	1	μA
I _{VFBL}	V _{FB} “L” Current	A/PV _{IN} = 5.5 V, V _{CE} = V _{FB} = 0 V		−1	0	1	μA
V _{OVD}	OVD Voltage	A/PV _{IN} = 3.6 V			0.72		V
V _{UVD}	UVD Voltage	A/PV _{IN} = 3.6 V			0.48		V

ELECTRICAL CHARACTERISTICS (continued)

RP506Lxx1x-TR-K

RP506L Electrical Characteristics by Different Output Voltage (−40°C ≤ Ta ≤ 125°C)

Product Name	V _{OUT} [V] (Ta = 25°C)			V _{OUT} [V] (Ta = -40 ~ 125°C)		
	Min.	Typ.	Max.	Min.	Typ.	Max.
RP506L081x	0.782	0.800	0.818	0.770	0.800	0.830
RP506L101x	0.982	1.000	1.018	0.970	1.000	1.030
RP506L111x	1.082	1.100	1.118	1.070	1.100	1.130
RP506L121x	1.182	1.200	1.218	1.170	1.200	1.230
RP506L131x	1.281	1.300	1.319	1.268	1.300	1.332
RP506L151x	1.478	1.500	1.522	1.463	1.500	1.537
RP506L181x	1.773	1.800	1.827	1.755	1.800	1.845
RP506L181x5	1.823	1.850	1.877	1.804	1.850	1.896
RP506L301x	2.955	3.000	3.045	2.925	3.000	3.075
RP506L331x	3.251	3.300	3.349	3.218	3.300	3.382

THEORY OF OPERATION

Soft-start Time Adjustment Function

Soft-start time (t_{start}) of the RP506L is adjustable by connecting a soft-start time adjustment capacitor (C_{SS}) between the TSS pin and GND. t_{start} can be set from Typ. 0.15 ms. As the figure below shows, if 0.1 μF C_{SS} is connected, t_{start} will be 30 ms. The TSS pin must be open if the soft-start time function is not used. t_{start} is set to 0.15 ms (Typ.) when the TSS pin is open.

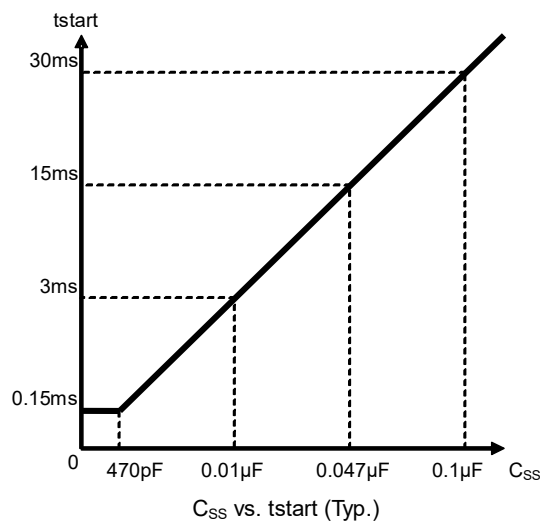

Soft-start Time (t_{start}) vs. Soft-start Time Adjustment Capacitor (C_{SS})

Power Good Function

The RP506L contains a power good function using Nch open drain. If any abnormal condition is detected, the power good function turns Nch transistor on and switches the PG pin to low. If the cause of the abnormal condition is removed, the power good function turns Nch transistor off and switches the PG pin back to high. After the recovery from abnormal condition, it takes typically 0.05 ms for the IC to turn Nch transistor off. The followings are the abnormal conditions that the power good function can detect.

- CE = "L" (Shut down)
- UVLO (Shut down)
- Thermal Shutdown
- Over Voltage Detection: Typ. $V_{SET} \times 1.2 \text{ V}$ (RP506Lxx1G/H/K/L) or 0.72 V (RP506L001N/M)
- Under Voltage Detection: Typ. $V_{SET} \times 0.8 \text{ V}$ (RP506Lxx1G/H/K/L) or 0.48 V (RP506L001N/M)
- Latch Type Protection

Notes: When using the power good function, the resistance of PG pin (R_{PG}) should be between 10 k Ω to 100 k Ω . The PG pin must be open or connected to GND if the power good function is not used.

Sequential Start-up Using Soft-start Time Adjustment and Power Good Functions

Sequential startup circuits can be built by using soft-start time adjustment and power good functions of the RP506L. The figure below is an example of sequential startup circuits using DC/DC1 and DC/DC2.

The DC/DC1 starts up first followed by the DC/DC2: the output of DC/DC1 reaches 1.44 V ($V_{SET} \times 0.8$), the PG pin of DC/DC1 sends a high signal to the CE pin of DC/DC2, and then the DC/DC2 starts soft-start.

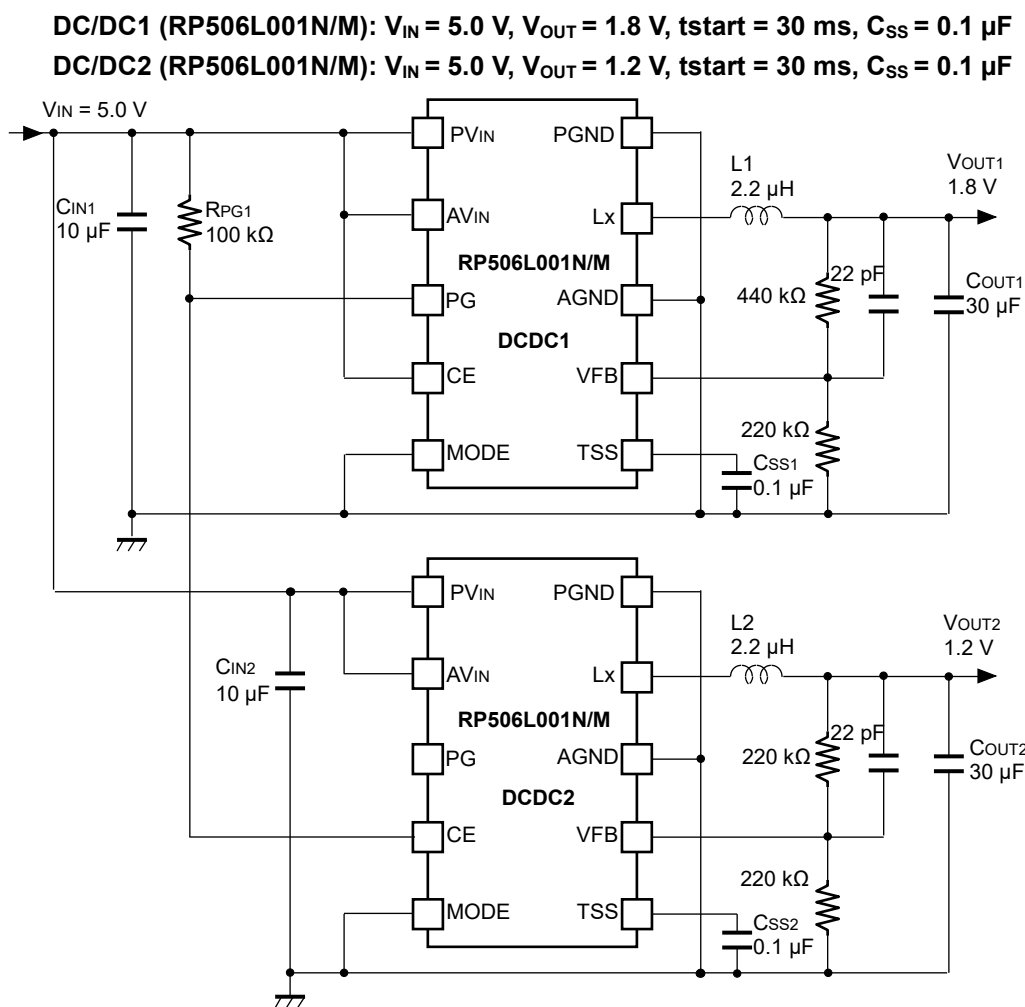

Circuits Example using Sequential Startup

Operation of Step-down DC/DC Converter and Output Current

The step-down DC/DC converter charges energy in the inductor when L_x Tr. turns "ON", and discharges the energy from the inductor when L_x Tr. turns "OFF" and controls with less energy loss, so that a lower output voltage (V_{OUT}) than the input voltage (V_{IN}) can be obtained. The operation of the step-down DC/DC converter is explained in the following figures.

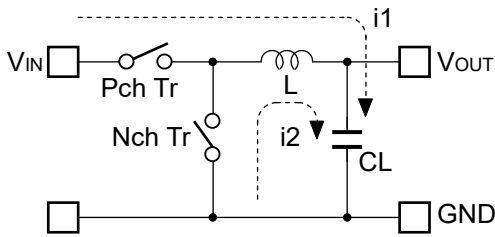
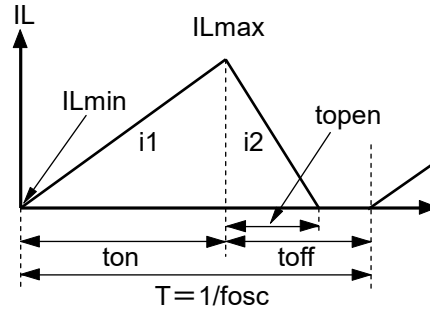
**Basic Circuit****Inductor Current (I_L) flowing through Inductor (L)**

- Step1.** Pch Tr. turns "ON" and I_L (i_1) flows, L is charged with energy. At this moment, i_1 increases from the minimum inductor current (I_{Lmin}), which is 0 A, and reaches the maximum inductor current (I_{Lmax}) in proportion to the on-time period (t_{on}) of Pch Tr.
- Step2.** When Pch Tr. turns "OFF", L tries to maintain I_L at I_{Lmax} , so L turns Nch Tr. "ON" and I_L (i_2) flows into L .
- Step3.** i_2 decreases gradually and reaches I_{Lmin} after the open-time period (t_{open}) of Nch Tr., and then Nch Tr. turns "OFF". This is called discontinuous current mode.
- As the output current (I_{OUT}) increases, the off-time period (t_{off}) of Pch Tr. runs out before I_L reaches I_{Lmin} . The next cycle starts, and Pch Tr. turns "ON" and Nch Tr. turns "OFF", which means I_L starts increasing from I_{Lmin} . This is called continuous current mode.

In the case of PWM mode, V_{OUT} is maintained by controlling t_{on} . During PWM mode, the oscillator frequency (f_{osc}) is being maintained constant.

When the step-down DC/DC operation is constant, I_{Lmin} and I_{Lmax} during t_{on} of Pch Tr. would be same as during t_{off} of Pch Tr. The current differential between I_{Lmax} and I_{Lmin} is described as ΔI .

$$\Delta I = I_{Lmax} - I_{Lmin} = V_{OUT} \times t_{open} / L = (V_{IN} - V_{OUT}) \times t_{on} / L \dots \dots \dots \text{Equation 1}$$

However,

$$T = 1 / f_{osc} = t_{on} + t_{off}$$

$$\text{duty (\%)} = t_{on} / T \times 100 = t_{on} \times f_{osc} \times 100$$

$$t_{open} \leq t_{off}$$

In Equation 1, " $V_{OUT} \times t_{open} / L$ " shows the amount of current change in "OFF" state. Also, " $(V_{IN} - V_{OUT}) \times t_{on} / L$ " shows the amount of current change at "ON" state.

Discontinuous Mode and Continuous Mode

As illustrated in Figure A, when I_{OUT} is relatively small, $t_{open} < t_{off}$. In this case, the energy charged into L during t_{on} will be completely discharged during t_{off} , as a result, $I_{Lmin} = 0$. This is called discontinuous mode. When I_{OUT} is gradually increased, eventually $t_{open} = t_{off}$ and when I_{OUT} is increased further, eventually $I_{Lmin} > 0$, as illustrated in Figure B. This is called continuous mode.

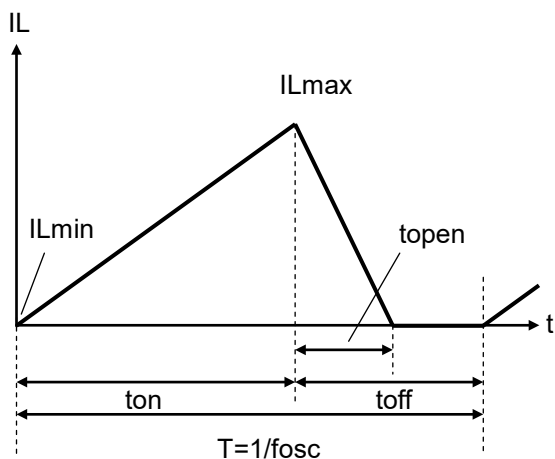

Figure A. Discontinuous Mode

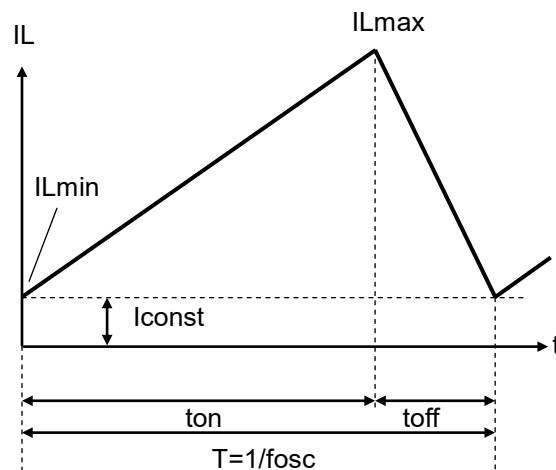

Figure B. Continuous Mode

In the continuous mode, the solution of Equation 1 is described as t_{onc} .

$$t_{onc} = T \times V_{OUT} / V_{IN} \dots\dots\dots \text{Equation 2}$$

When $t_{on} < t_{onc}$, it is discontinuous mode, and when $t_{on} = t_{onc}$, it is continuous mode.

Forced PWM Mode

By setting the MODE pin to “H”, the IC switches the frequency at the fixed rate to reduce noise even when the output load is light. Therefore, when I_{OUT} is $\Delta I_L/2$ or less, I_{Lmin} becomes less than 0. That is, the accumulated electricity in CL is discharged through the IC side while I_L is increasing from I_{Lmin} to 0 during t_{on} , and also while I_L is decreasing from 0 to I_{Lmin} during t_{off} .

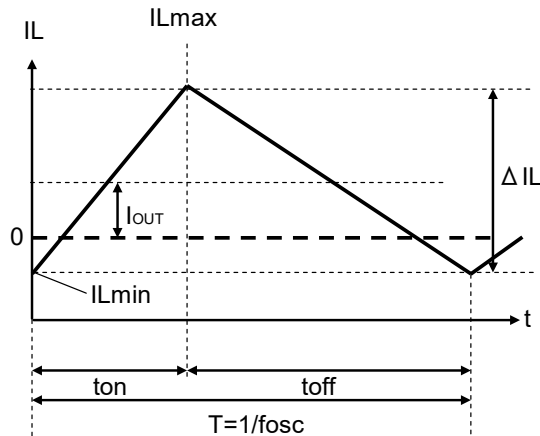
**Forced PWM Mode****VFM Mode**

By setting the MODE pin to “L”, in low output current, the IC automatically switches into VFM mode in order to achieve high efficiency. In VFM mode, t_{on} is forced to end when the inductor current reaches the pre-set I_{Lmax} . In the VFM mode, I_{Lmax} is typically set to 400 mA for the RP506Lxx1G/H//N, and 550 mA for the RP506Lxx1K/L/M. When t_{on} reaches 1.5 times of $T = 1 / f_{osc}$, t_{on} will be forced to end even if the inductor current is not reached I_{Lmax} .

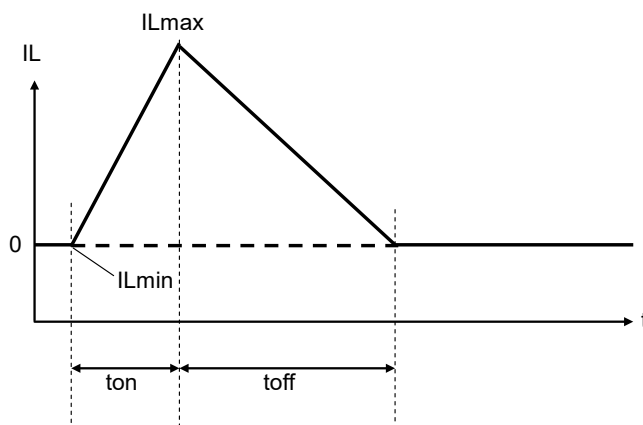
**VFM Mode**

Output Current and Selection of External Components

The following equations explain the relationship between output current and peripheral components that are listed in *Table 1. Recommended External Components in Typical Application*.

Ripple Current P-P value is described as I_{RP} , ON resistance of Pch Tr. is described as R_{ONP} , ON resistance of Nch Tr. is described as R_{ONN} , and DC resistor of the inductor is described as R_L .

First, when Pch Tr. is "ON", the following equation is satisfied.

$$V_{IN} = V_{OUT} + (R_{ONP} + R_L) \times I_{OUT} + L \times I_{RP} / t_{on} \dots\dots\dots \text{Equation 3}$$

Second, when Pch Tr. is "OFF" (Nch Tr. is "ON"), the following equation is satisfied.

$$L \times I_{RP} / t_{off} = R_{ONN} \times I_{OUT} + V_{OUT} + R_L \times I_{OUT} \dots\dots\dots \text{Equation 4}$$

Put Equation 4 into Equation 3 to solve ON duty of Pch Tr. ($D_{ON} = t_{on} / (t_{off} + t_{on})$):

$$D_{ON} = (V_{OUT} + R_{ONN} \times I_{OUT} + R_L \times I_{OUT}) / (V_{IN} + R_{ONN} \times I_{OUT} - R_{ONP} \times I_{OUT}) \dots\dots\dots \text{Equation 5}$$

Ripple Current is described as follows:

$$I_{RP} = (V_{IN} - V_{OUT} - R_{ONP} \times I_{OUT} - R_L \times I_{OUT}) \times D_{ON} / f_{osc} / L \dots\dots\dots \text{Equation 6}$$

Peak current that flows through L, and Lx Tr. is described as follows:

$$I_{Lxmax} = I_{OUT} + I_{RP} / 2 \dots\dots\dots \text{Equation 7}$$

Notes: Please consider I_{Lxmax} when setting conditions of input and output, as well as selecting the external components. The above calculation formulas are based on the ideal operation of the ICs in continuous mode.

Timing Chart**(1) Soft-start Time****Starting-up with CE Pin**

The IC starts to operate when the CE pin voltage (V_{CE}) exceeds the threshold voltage. The threshold voltage is preset between CE "H" input voltage (V_{CEH}) and CE "L" input voltage (V_{CEL}).

After the start-of the start-up of the IC, soft-start circuit starts to operate. Then, after a certain period of time, the reference voltage (V_{REF}) in the IC gradually increases up to the specified value.

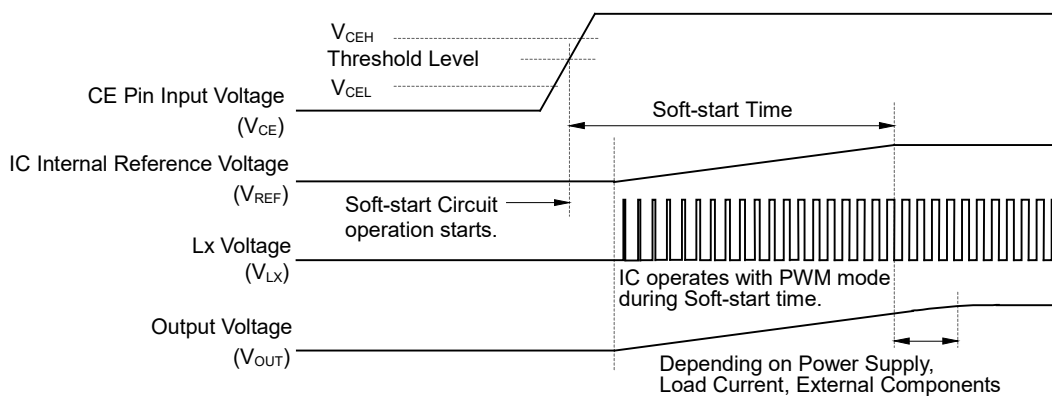
**Timing Chart**

Soft-start time starts when soft-start circuit is activated, and ends when the reference voltage reaches the specified voltage.

Notes: Soft start time is not always equal to the turn-on speed of the step-down DC/DC converter. Please note that the turn-on speed could be affected by the power supply capacity, the output current, the inductance value and the C_{OUT} value.

Starting-up with Power Supply

After the power-on, when V_{IN} exceeds the UVLO released voltage (V_{UVLO2}), the IC starts to operate. Then, soft-start circuit starts to operate and after a certain period of time, V_{REF} gradually increases up to the specified value. Soft-start time starts when soft-start circuit is activated, and ends when V_{REF} reaches the specified value.

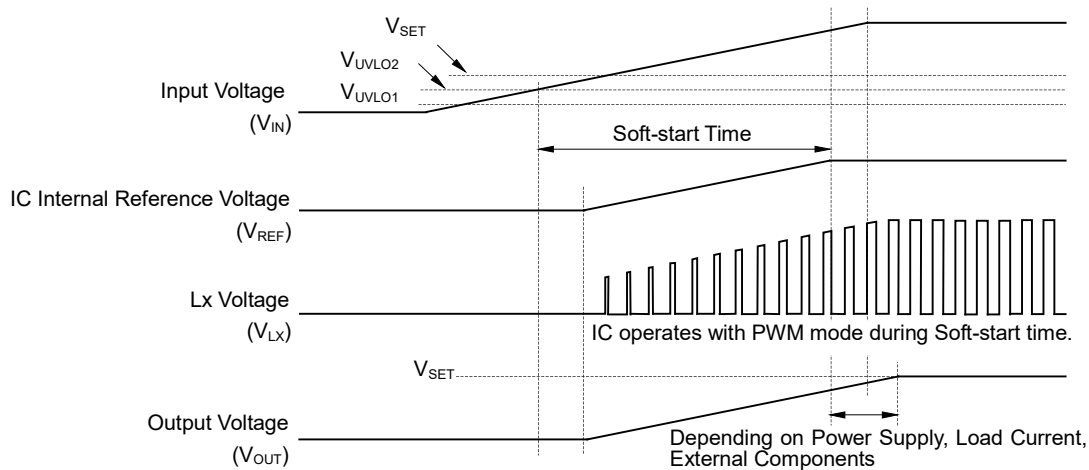

Timing Chart

Notes: Please note that the turn-on speed of V_{OUT} could be affected by the power supply capacity, the output current, the inductance value, the C_{OUT} value and the turn-on speed of V_{IN} determined by C_{IN} .

(2) Under Voltage Lockout (UVLO) Circuit

If V_{IN} becomes lower than V_{SET} , the step-down DC/DC converter stops the switching operation and ON duty becomes 100%, and then V_{OUT} gradually drops according to V_{IN} .

If the V_{IN} drops more and becomes lower than the UVLO detector threshold (V_{UVLO1}), the UVLO circuit starts to operate, V_{REF} stops, and Pch and Nch built-in switch transistors turn "OFF". As a result, V_{OUT} drops according to the C_{OUT} capacitance value and the load.

To restart the operation, V_{IN} needs to be higher than V_{UVLO2} . The timing chart below shows the voltage shifts of V_{REF} , V_{LX} and V_{OUT} when V_{IN} value is varied.

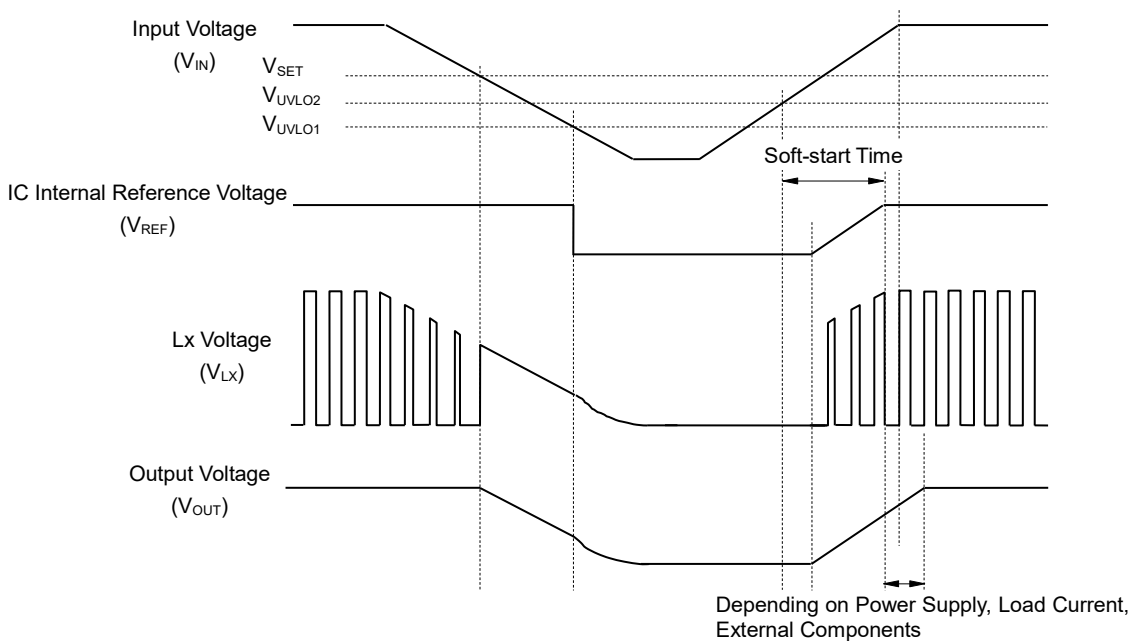
**Timing Chart**

Notes: Falling edge (operating) and rising edge (releasing) waveforms of V_{OUT} could be affected by the initial voltage of C_{OUT} and the output current of V_{OUT} .

(3) Over Current Protection Circuit, Latch Type Protection Circuit

Over current protection circuit supervises the inductor peak current (the peak current flowing through Pch Tr.) in each switching cycle, and if the current exceeds the Lx current limit (I_{LXLIM}), it turns off Pch Tr. I_{LXLIM} of the RP506L is set to Typ.2800 mA.

Latch type protection circuit latches the built-in driver to the OFF state and stops the operation of the step-down DC/DC converter if the over current status continues or V_{OUT} continues being the half of the setting voltage for equal or longer than protection delay time (t_{prot}). To release the latch type protection circuit, restart the IC by inputting "L" signal to the CE pin, or restart the IC with power-on or make the supply voltage lower than V_{UVLO1} .

Notes: I_{LXLIM} and t_{prot} could be easily affected by self-heating or ambient environment. If the V_{IN} drops dramatically or becomes unstable due to short-circuit, protection operation and t_{prot} could be affected.

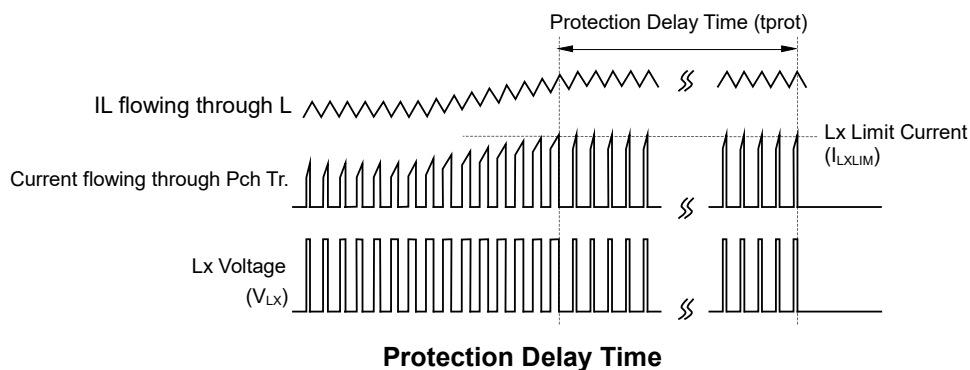

RP506L

No. EC-296-210909

The timing chart below shows the voltage shift of V_{CE} , V_{LX} and V_{OUT} when the IC status is changed by the following orders: V_{IN} rising → stable operation → high load → CE reset → stable operation → V_{IN} falling → V_{IN} recovering (UVLO reset) → stable operation.

- (1)(2) If the large current flows through the circuit or the IC goes into low V_{OUT} condition due to short-circuit or other reasons, the latch type protection circuit latches the built-in driver to "OFF" state after t_{prot} . Then, V_{LX} becomes "L" and V_{OUT} turns "OFF".
- (3) The latch type protection circuit is released by CE reset, which puts the IC into "L" once with the CE pin and back into "H".
- (4) The latch type protection circuit is released by UVLO reset, which makes V_{IN} lower than V_{UVLO1} .

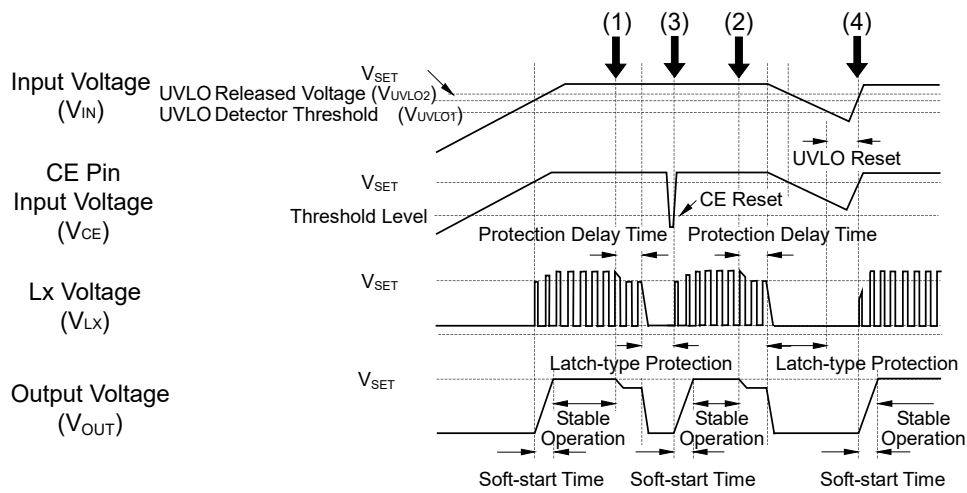
**Timing Chart**

APPLICATION INFORMATION

Typical Application

PG function is used, 30 ms Soft-start Time

(¹)MODE = "H": forced PWM control, MODE = "L": PWM/VFM auto switching control

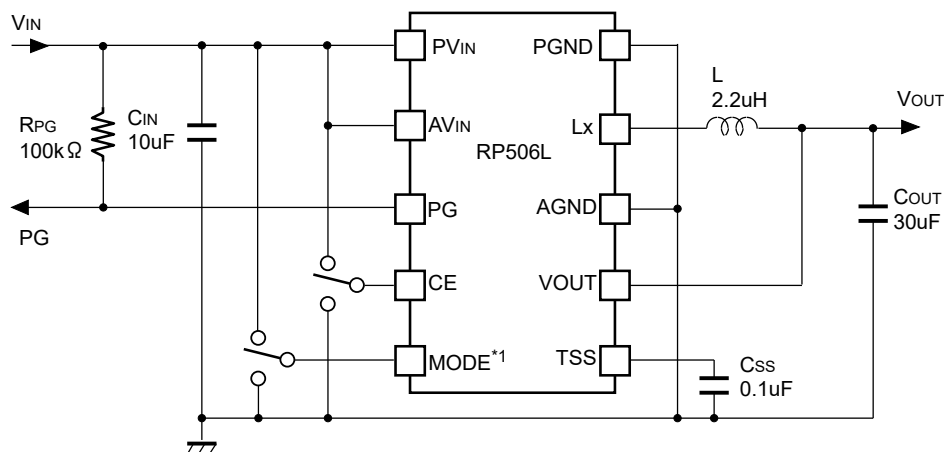

RP506Lxx1G/H/K/L (Fixed Output Voltage Type)

PG function is not used, 150 μs Soft-start Time

(¹)MODE = "H": forced PWM control, MODE = "L": PWM/VFM auto switching control

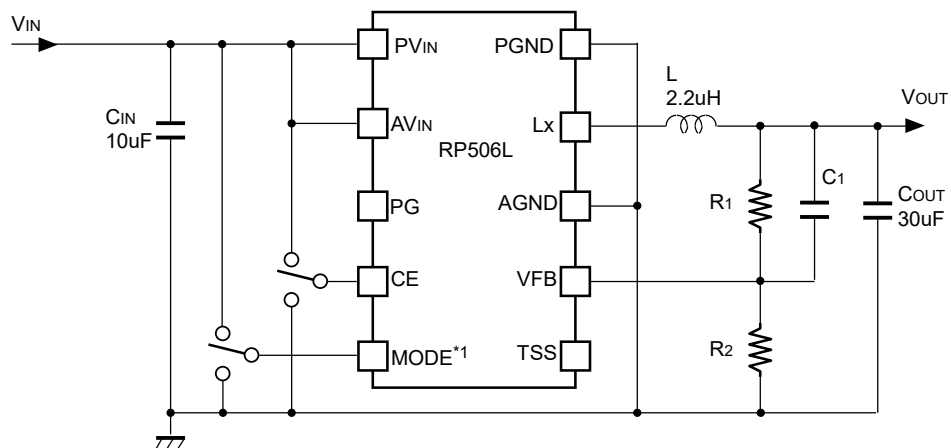

RP506L001N/M (Adjustable Output Voltage Type)

(¹) $V_{SET} > 3.3\text{ V}$ is only for RP506L001N/M.

RP506L

No. EC-296-210909

Table 1. Recommended External Components

Symbol	Size	Part Description	Model
C _{IN}	10 μF	Ceramic Capacitor	C1608JB0J106M (TDK)
			JMK107BJ106MA (TAIYO)
			CGA4J1X7R0J106K125AC(TDK)
C _{OUT}	22 μF × 2	Ceramic Capacitor	C2012JB0J226M (TDK)
			CGA5L1X7R0J226M160AC(TDK)
	10 μF × 3	Ceramic Capacitor	C1608JB0J106M (TDK)
			JMK107BJ106MA (TAIYO)
L (V _{SET} ≤ 3.3 V)	2.2 μH	Inductor	CGA4J1X7R0J106K125AC(TDK)
			SLF6045T-2R2N3R3 (TDK)
			CLF7045-2R2N (TDK)
			FDSD0415-2R2M (TOKO)
			RLF7030T-2R2M5R4 (TDK)
L (V _{SET} > 3.3 V) ⁽¹⁾	4.7 μH	Inductor	CLF7045-2R2N-D (TDK)
			SLF6045T-4R7N2R4 (TDK)
			CLF7045-4R7N (TDK)
			FDSD0415-4R7M (TOKO)
			RLF7030T-4R7M3R4 (TDK)
			CLF7045-4R7N-D (TDK)

Small and Low Profile External Components

Symbol	Size	Part Description	Model
L (V _{SET} ≤ 1.5V)	1.0 μH	Inductor	DFE252010R-H-1R0M (TOKO)
			VLS252010HBX-1R0M (TDK)
L (V _{SET} ≤ 2.3V)	1.5 μH	Inductor	DFE252010R-H-1R5M (TOKO)
			VLS252010HBX-1R5M (TDK)
L	2.2 μH	Inductor	DFE252010R-H-2R2M (TOKO)
			VLS252010HBX-2R2M (TDK)

⁽¹⁾ V_{SET} > 3.3 V is only for RP506L001N/M.

TECHNICAL NOTES

The performance of a power source circuit using this device is highly dependent on a peripheral circuit. A peripheral component or the device mounted on PCB should not exceed a rated voltage, a rated current or a rated power. When designing a peripheral circuit, please be fully aware of the following points.

- AGND and PGND must be wired to the GND plane when mounting on boards.
- AV_{IN} and PV_{IN} must be wired to the V_{IN} plane when mounting on boards.
- Ensure the A/PV_{IN} and A/PGND lines are sufficiently robust. A large switching current flows through the A/ PGND line, the V_{DD} line, the V_{OUT} line, an inductor, and L_X. If their impedance is too high, noise pickup or unstable operation may result. Set the external components as close as possible to the IC and minimize the wiring between the components and the IC. Especially, place a capacitor (C_{IN}) as close as possible to the PV_{IN} pin and PGND. For the RP506Lxx1G/H/K/L, separate the wiring between the V_{OUT} pin and an inductor (L1) from the wiring between L1 and Load. Likewise, for the RP506L001N/M, separate the wiring between a resistor for setting output voltage (R1) and an inductor (L2) from the wiring between L2 and Load.
- Choose a low ESR ceramic capacitor. The ceramic capacitance of C_{IN} should be more than or equal to 10 μF. For a ceramic capacitor (C_{OUT}), it is recommended that three paralleled 10 μF ceramic capacitors or two paralleled 22 μF ceramic capacitors be used.
- When V_{SET} ≤ 3.3 V, a 2.2 μH inductor is recommended for RP506Lxx1G/H//N/K/L/M. When V_{SET} ≤ 2.3 V, a 1.5 μH inductor can be used for RP506Lxx1G/H//N. When V_{SET} ≤ 1.5 V, a 1 μH inductor can be used for RP506Lxx1G/H//N. When V_{SET} > 3.3 V, a 4.7 μH inductor is recommended for RP506L001N/M. The phase compensation of this IC is designed according to the C_{OUT} and L values. Choose an inductor that has small DC resistance, has enough allowable current and is hard to cause magnetic saturation. If the inductance value of an inductor is extremely small, the peak current of L_X may increase along with the load current. As a result, over current protection circuit may start to operate when the peak current of L_X reaches to “L_X limit current”.

Set Output Voltage (V_{SET}) Range vs. Inductance Range

Version	RP506Lxx1G/H			RP506Lxx1K/L
	L = 1.0 μH	L = 1.5 μH	L = 2.2 μH	L = 2.2 μH
up to 1.5	Acceptable	Acceptable	Recommended	Recommended
1.6 to 2.3	-	Acceptable	Recommended	Recommended
2.4 to 3.3	-	-	Recommended	Recommended

Version	RP506L001N				RP506L001M	
	L = 1.0 μH	L = 1.5 μH	L = 2.2 μH	L = 4.7 μH	L = 2.2 μH	L = 4.7 μH
up to 1.5	Acceptable	Acceptable	Recommended	-	Recommended	-
1.6 to 2.3	-	Acceptable	Recommended	-	Recommended	-
2.4 to 3.3	-	-	Recommended	-	Recommended	-
3.4 or more	-	-	-	Recommended	-	Recommended

RP506L

No. EC-296-210909

- Overcurrent protection circuit and latch type protection circuit may be affected by self-heating or power dissipation environment.
- The output voltage (V_{OUT}) is adjustable by changing the resistance values of resistors ($R1$, $R2$) as follows.

$$V_{OUT} = V_{FB} \times (R1 + R2) / R2$$

Recommended V_{OUT} range for RP506L001M: $0.6 \text{ V} \leq V_{SET} \leq 4.0 \text{ V}$,

Recommended V_{OUT} range for RP506L001N: $0.8 \text{ V} \leq V_{SET} \leq 4.0 \text{ V}$

If $R1$ and $R2$ are too large, the impedances of V_{FB} also become large, as a result, the IC could be easily affected by noise. For this reason, $R2$ should be 220 k Ω or less. If the operation becomes unstable due to the high impedances, the impedances should be decreased.

$C1$ can be calculated by the following equations. Please use the value close to the calculation result.

If the output voltage is lower than or equal to 3.3 V:

$$C1 = 4.84 \times 10^{-6} / R2 \text{ [F]}$$

If the output voltage exceeds 3.3 V:

$$C1 = 1.50 \times 10^{-6} / R2 \text{ [F]}$$

The recommended resistance values for $R1$ and $C1$ when $R2 = 220 \text{ k}\Omega$ or $100 \text{ k}\Omega$ are as follows.

Set Output Voltage (V_{SET}) vs. Resistors ($R1$, $R2$) and Capacitor ($C1$)

V_{SET} [V]	0.6	0.7	0.8	1.2	1.8	2.5	3.3	3.8	4.0
$R1$ [k Ω]	0	36.7	73.3	220	440	697	990	533	567
$R2$ [k Ω]	220	220	220	220	220	220	220	100	100
$C1$ [pF]	-	22	22	22	22	22	22	15	15

- Soft-start Time (t_{start}) is adjustable by connecting a capacitor (C_{SS}) between the TSS pin and GND. The capacitance value for C_{SS} that is suitable for t_{start} can be calculated by the following equation.

$$C_{SS} \text{ (nF)} = 3.5 \times t_{start} \text{ (ms)}$$

The TSS pin must be open if Soft-start time function is not used. Soft-start time is set to typically 150 μs when the TSS pin is open.

- When using the power good function, the resistance value of a resistor (R_{PG}) should be between 10 k Ω to 100 k Ω . The PG pin must be open or connected to GND if the power good function is not used.

PCB Layout

RP506Lxx1G/H/K/L (PKG: DFN3030-12 pin) PCB Layout

Topside

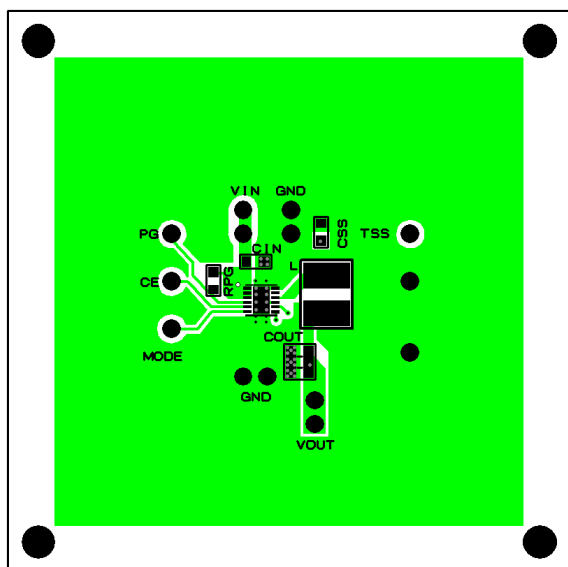

Backside

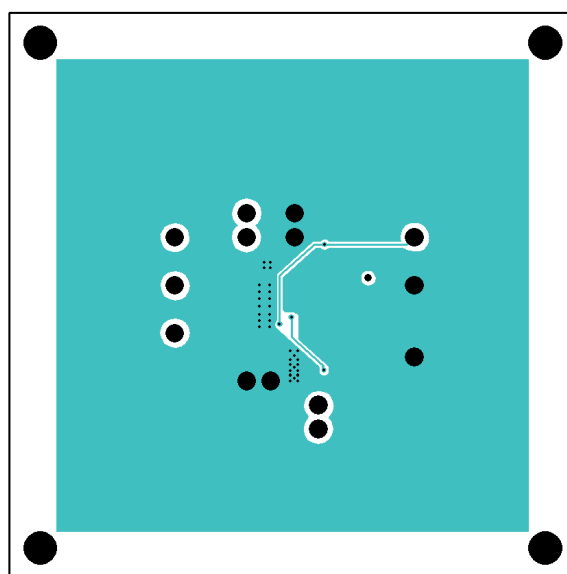

RP506L001N/M (PKG: DFN3030-12 pin) PCB Layout

Topside

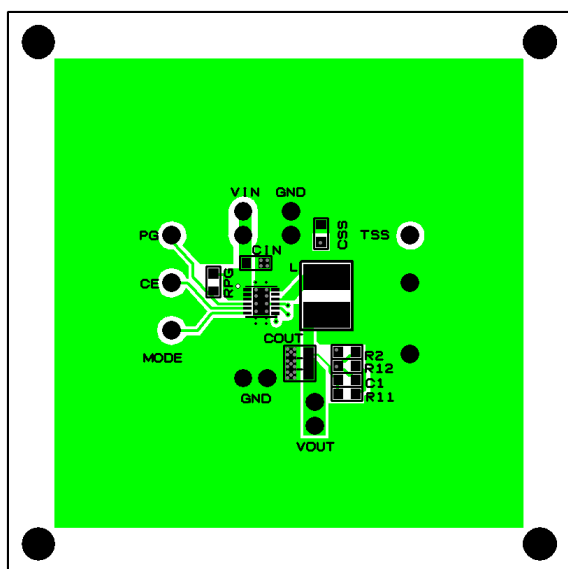

Backside

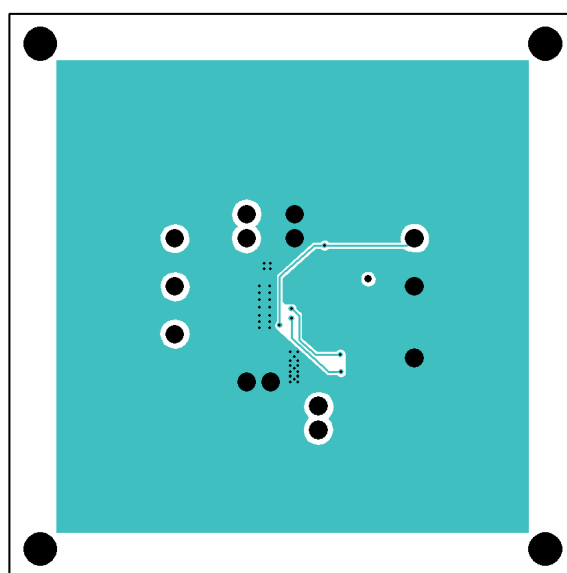

R11 and R12 are arranged as a substitute for R1 so that two resistors can be connected in series.

TYPICAL CHARACTERISTICS

Note: Typical Characteristics are intended to be used as reference data; they are not guaranteed.

1) Output Voltage vs. Output Current

RP506Lxx1G/H/N $V_{OUT} = 1.2\text{ V}$
MODE = "L" PWM/VFM Auto Switching Control

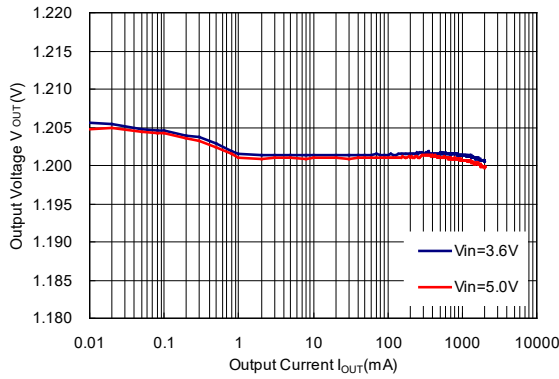

RP506Lxx1G/H/N $V_{OUT} = 1.2\text{ V}$
MODE = "H" Forced PWM Control

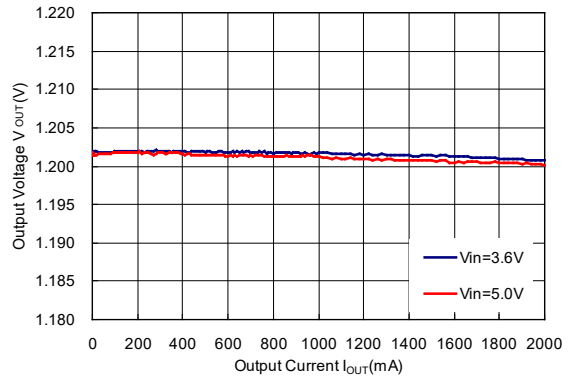

RP506Lxx1G/H/N $V_{OUT} = 1.5\text{ V}$
MODE = "L" PWM/VFM Auto Switching Control

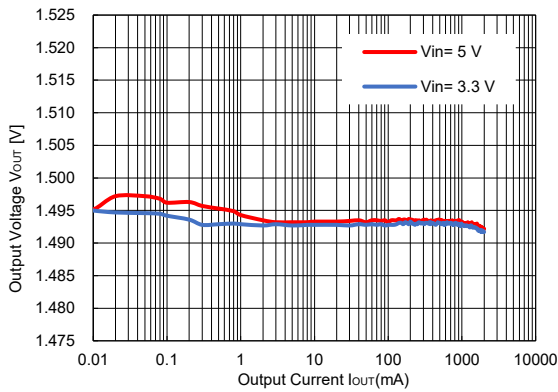

RP506Lxx1G/H/N $V_{OUT} = 1.5\text{ V}$
MODE = "H" Forced PWM Control

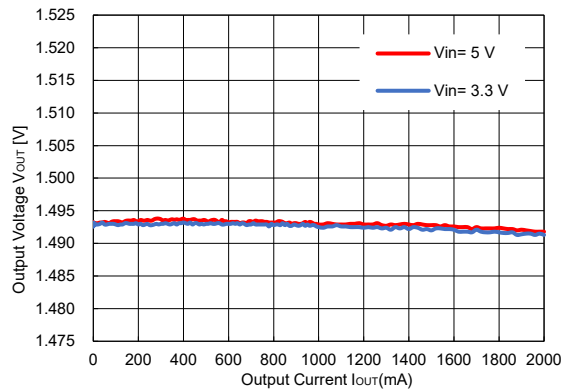

RP506Lxx1G/H/N $V_{OUT} = 1.8\text{ V}$
MODE = "L" PWM/VFM Auto Switching Control

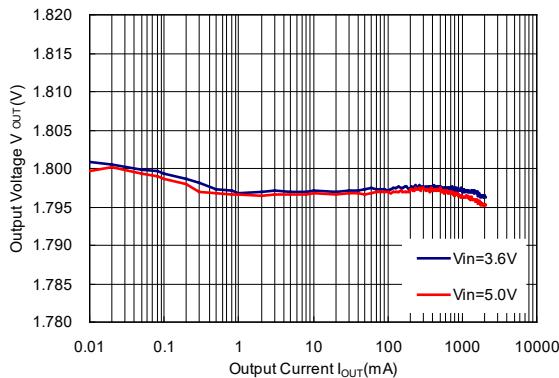

RP506Lxx1G/H/N $V_{OUT} = 1.8\text{ V}$
MODE = "H" Forced PWM Control

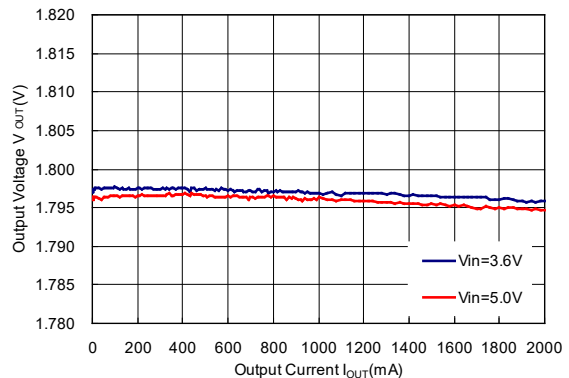

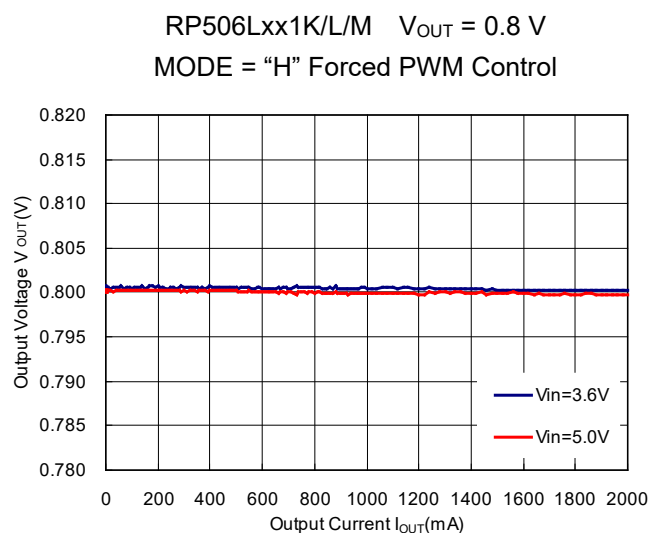
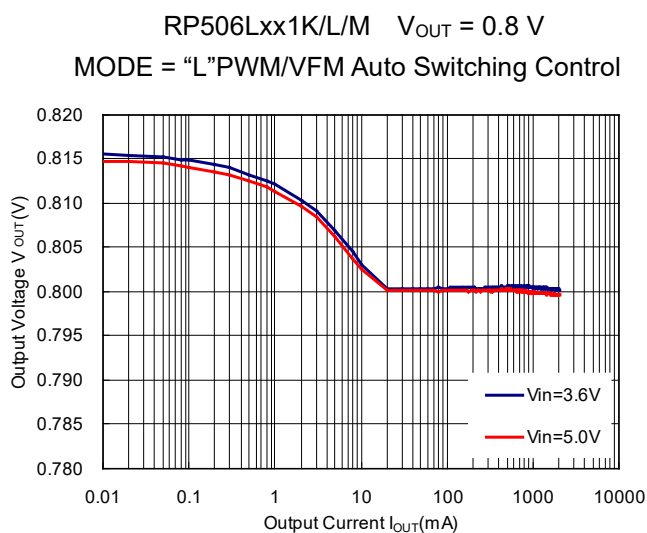
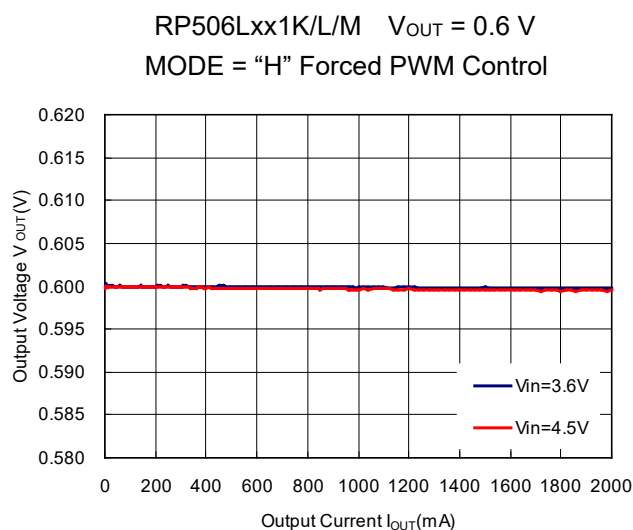
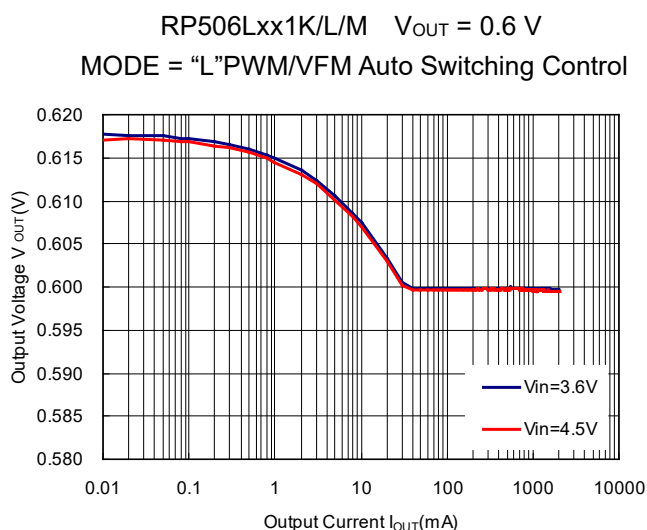
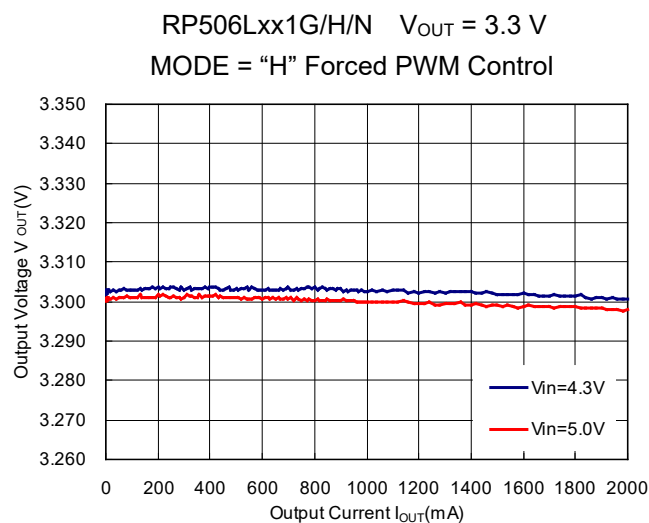
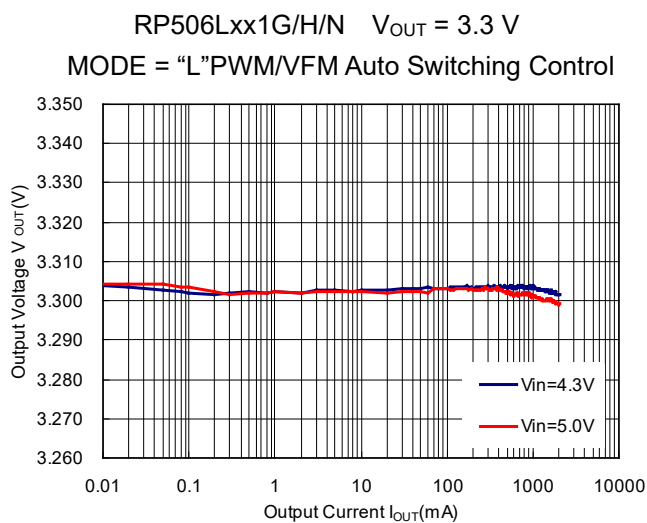

RP506L

No. EC-296-210909

RP506Lxx1K/L/M $V_{OUT} = 1.2\text{ V}$
MODE = "L" PWM/VFM Auto Switching Control

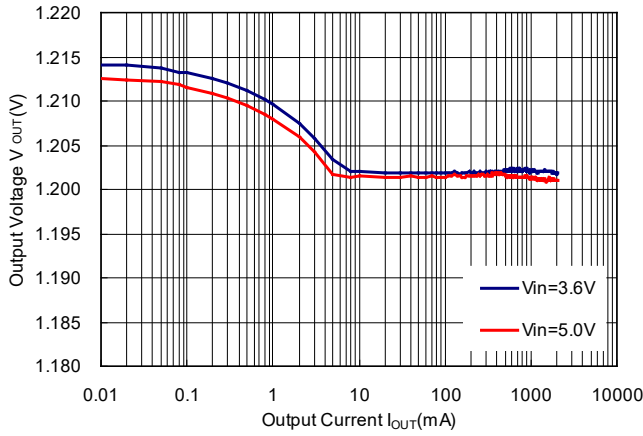

RP506Lxx1K/L/M $V_{OUT} = 1.2\text{ V}$
MODE = "H" Forced PWM Control

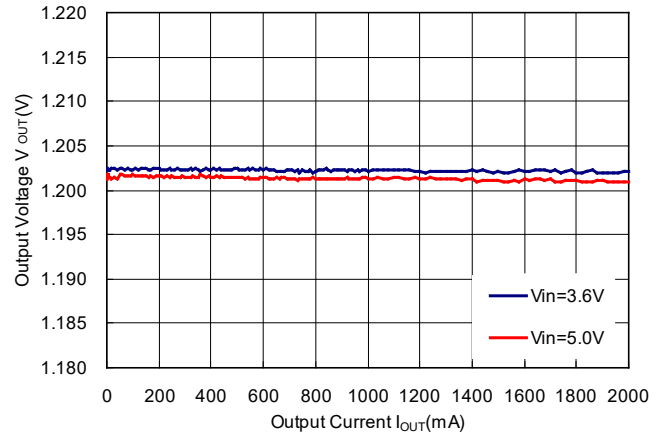

RP506Lxx1K/L/M $V_{OUT} = 1.8\text{ V}$
MODE = "L" PWM/VFM Auto Switching Control

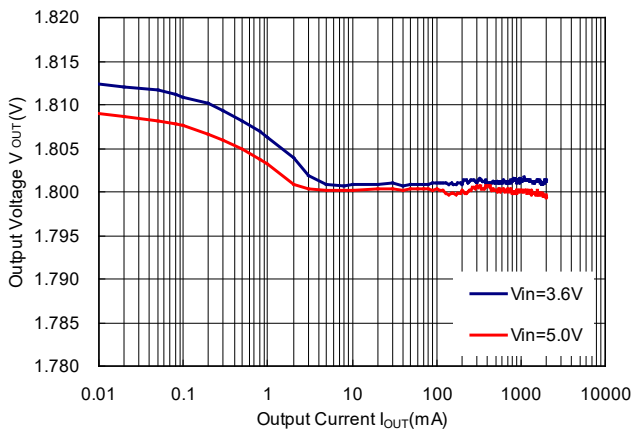

RP506Lxx1K/L/M $V_{OUT} = 1.8\text{ V}$
MODE = "H" Forced PWM Control

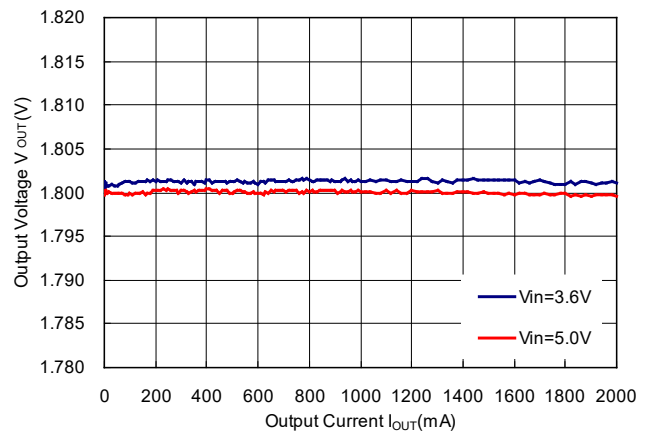

RP506Lxx1K/L/M $V_{OUT} = 3.3\text{ V}$
MODE = "L" PWM/VFM Auto Switching Control

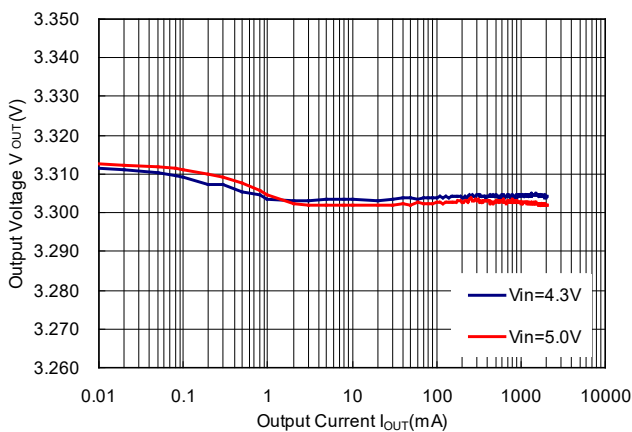

RP506Lxx1K/L/M $V_{OUT} = 3.3\text{ V}$
MODE = "H" Forced PWM Control

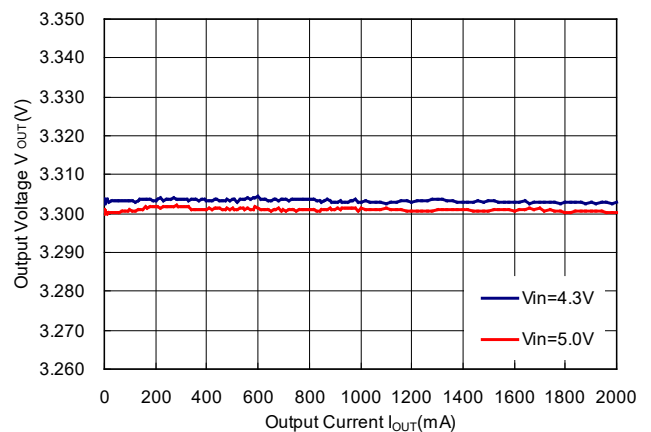

2) Output Voltage vs. Input Voltage

RP506Lxx1K/L/M $V_{OUT} = 0.6\text{ V}$
MODE = "H" Forced PWM Control

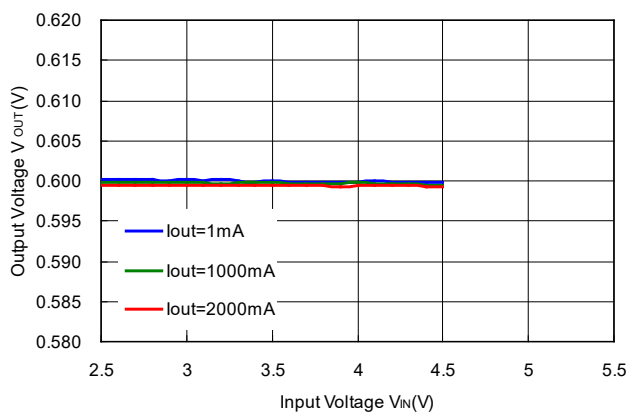

RP506Lxx1K/L/M $V_{OUT} = 0.8\text{ V}$
MODE = "H" Forced PWM Control

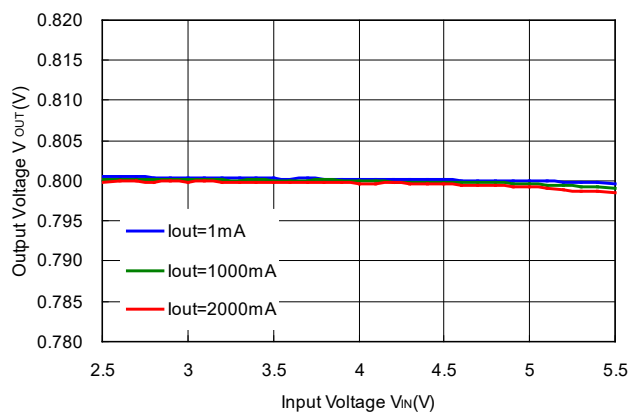

RP506L $V_{OUT} = 1.2\text{ V}$
MODE = "H" Forced PWM Control

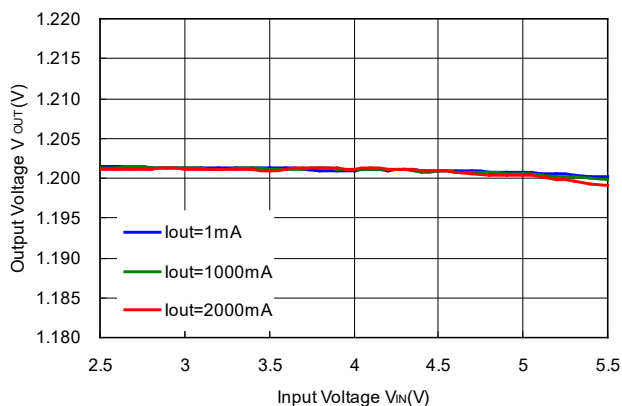

RP506L $V_{OUT} = 1.8\text{ V}$
MODE = "H" Forced PWM Control

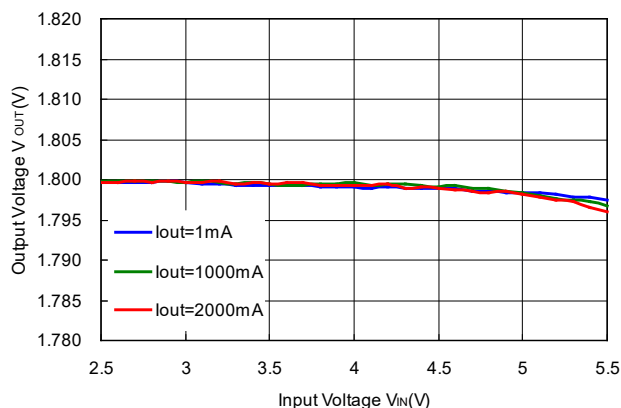

RP506L $V_{OUT} = 3.3\text{ V}$
MODE = "H" Forced PWM Control

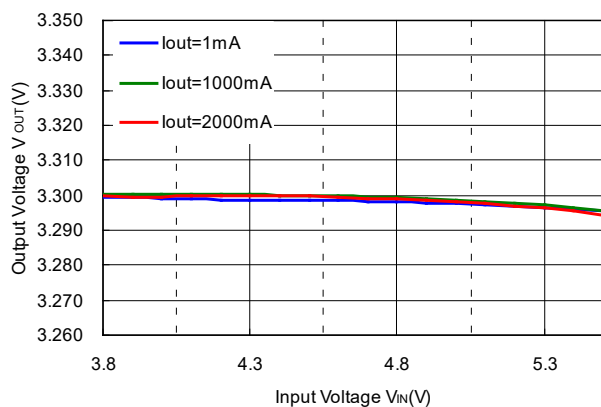

RP506L

No. EC-296-210909

3) Output Voltage vs. Ambient Temperature

RP506L181G/H/K/L $V_{OUT} = 1.8\text{ V}$

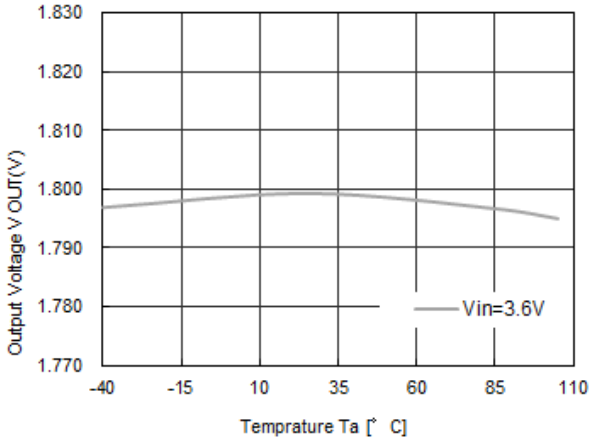

4) Feedback Voltage vs. Ambient Temperature

RP506L001N/M

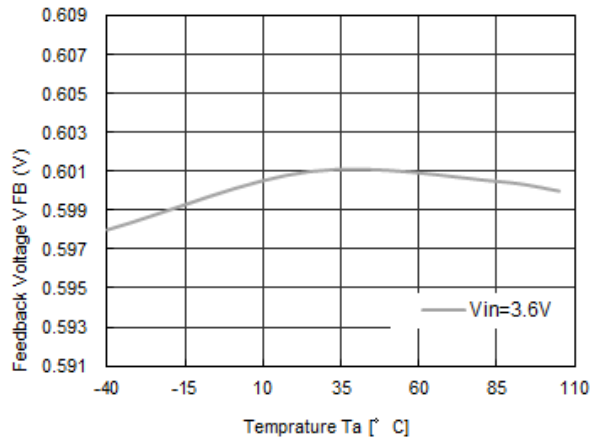

5) Efficiency vs. Output Current

RP506Lxx1G/H/N $V_{OUT} = 1.2\text{ V}$

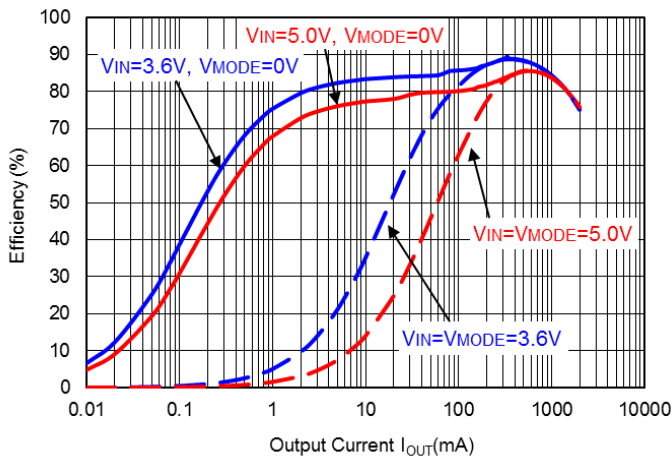

RP506Lxx1G/H/N $V_{OUT} = 1.5\text{ V}$

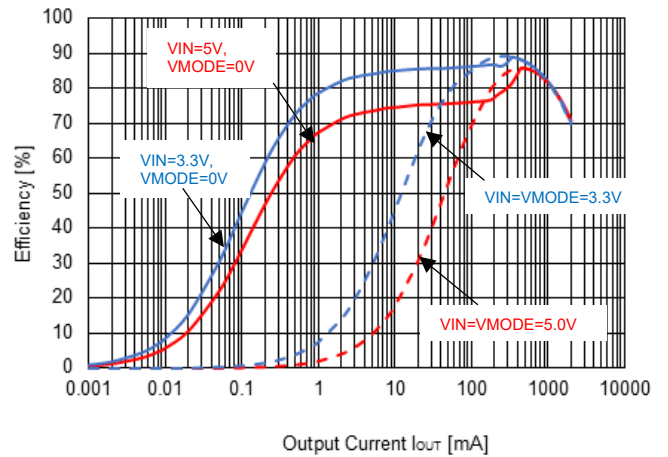

RP506Lxx1G/H/N $V_{OUT} = 1.8\text{ V}$

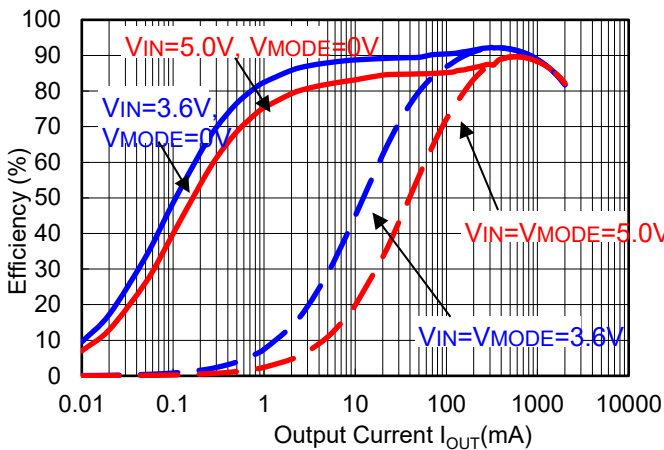

RP506Lxx1G/H/N $V_{OUT} = 3.3\text{ V}$

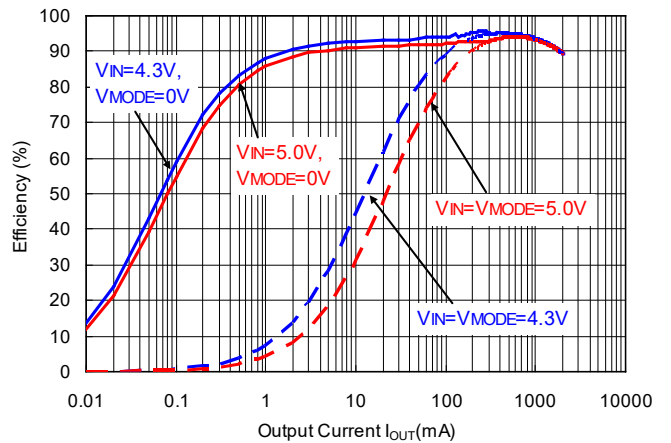

RP506Lxx1K/L/M $V_{OUT} = 0.6\text{ V}$

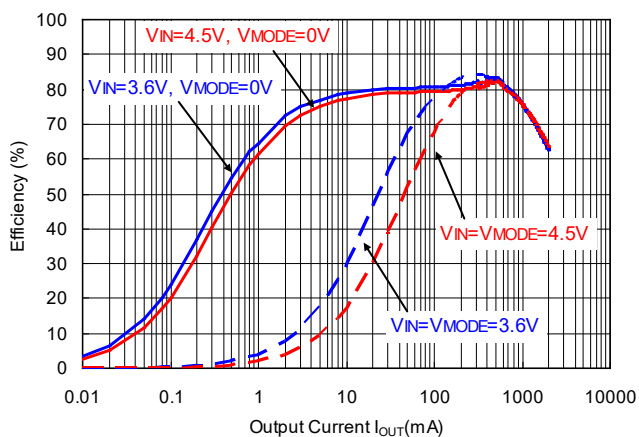

RP506Lxx1K/L/M $V_{OUT} = 0.8\text{ V}$

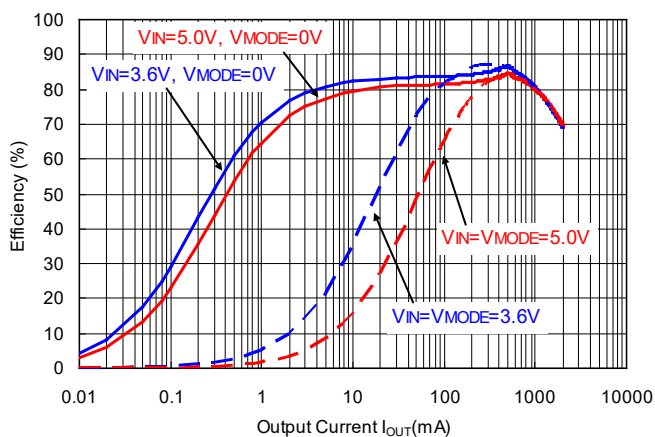

RP506Lxx1K/L/M $V_{OUT} = 1.2\text{ V}$

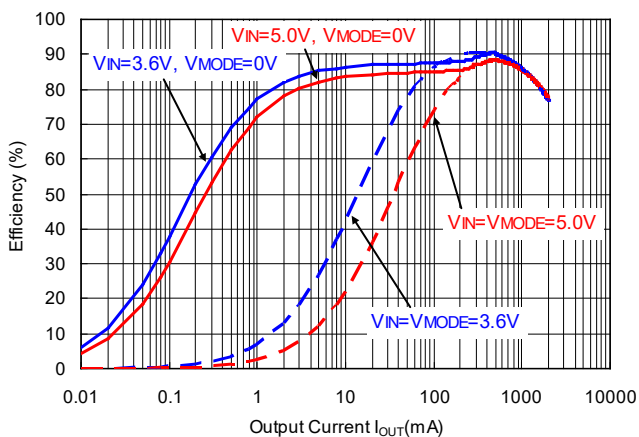

RP506Lxx1K/L/M $V_{OUT} = 1.8\text{ V}$

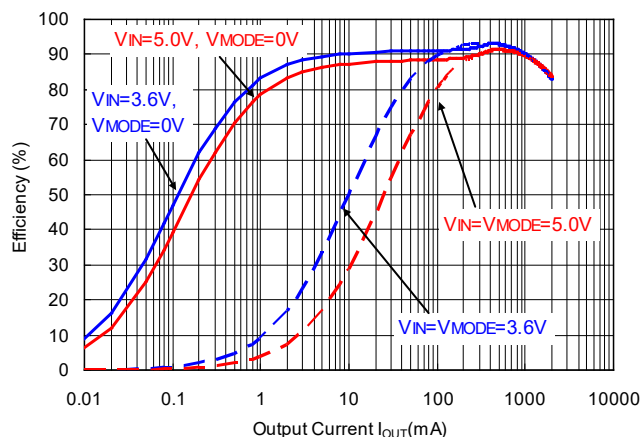

RP506Lxx1K/L/M $V_{OUT} = 3.3\text{ V}$

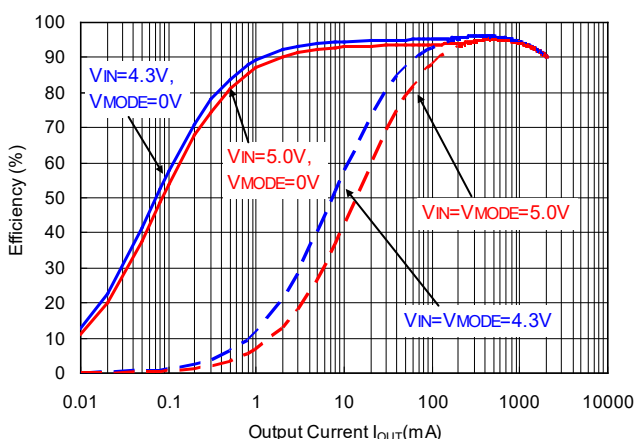

RP506L

No. EC-296-210909

6) Supply Current vs. Ambient Temperature

RP506L $V_{OUT} = 1.8\text{ V}$ ($V_{IN} = 5.5\text{ V}$)

MODE = "L" PWM/VFM Auto Switching Control

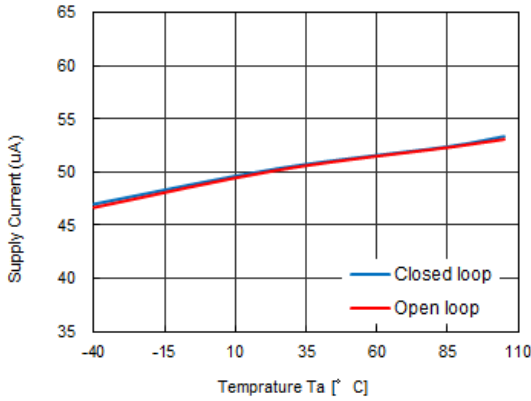

7) Supply Current vs. Input Voltage

RP506L $V_{OUT} = 1.8\text{ V}$

MODE = "L" PWM/VFM Auto Switching Control

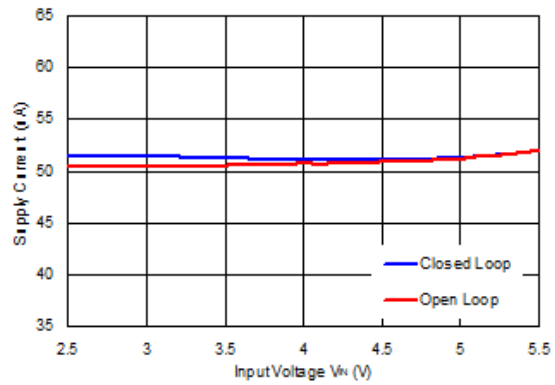

8) Output Voltage Waveform

RP506Lxx1G/H/N $V_{OUT} = 0.8\text{ V}$ ($V_{IN} = 3.6\text{ V}$)

MODE = "L" PWM/VFM Auto Switching Control

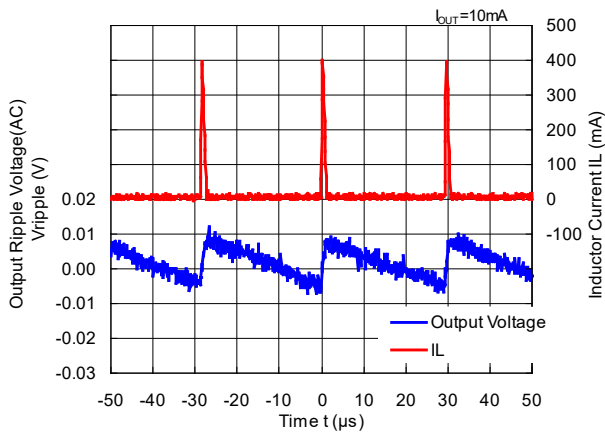

RP506Lxx1G/H/N $V_{OUT} = 1.2\text{ V}$ ($V_{IN} = 3.6\text{ V}$)

MODE = "L" PWM/VFM Auto Switching Control

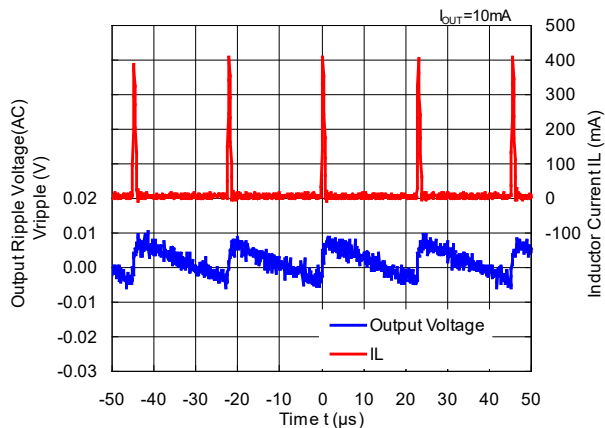

RP506Lxx1G/H/N $V_{OUT} = 1.2\text{ V}$ ($V_{IN} = 3.6\text{ V}$)

MODE = "H" Forced PWM Control

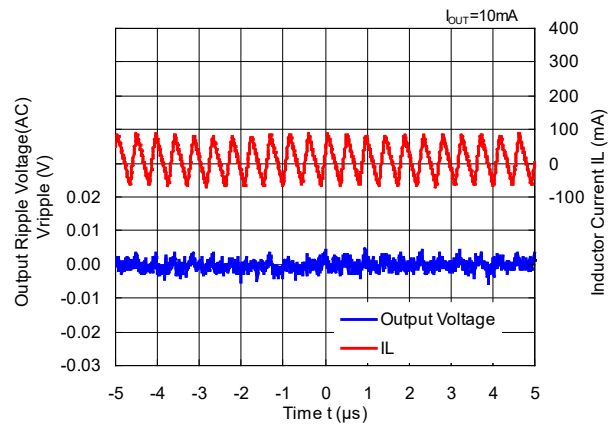

RP506Lxx1G/H/N $V_{OUT} = 1.8\text{ V}$ ($V_{IN} = 3.6\text{ V}$)
 MODE = "L" PWM/VFM Auto Switching Control

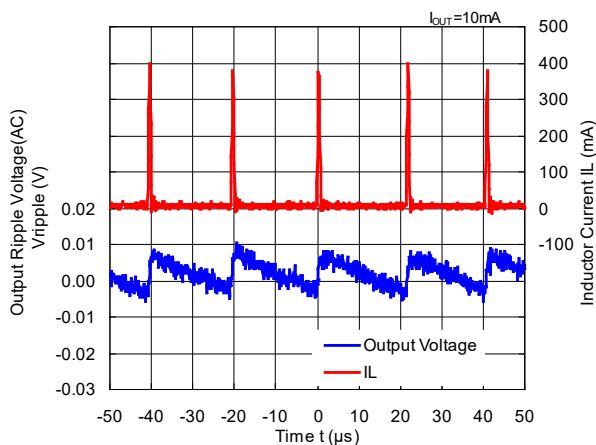

RP506Lxx1G/H/N $V_{OUT} = 1.8\text{ V}$ ($V_{IN} = 3.6\text{ V}$)
 MODE = "H" Forced PWM Control

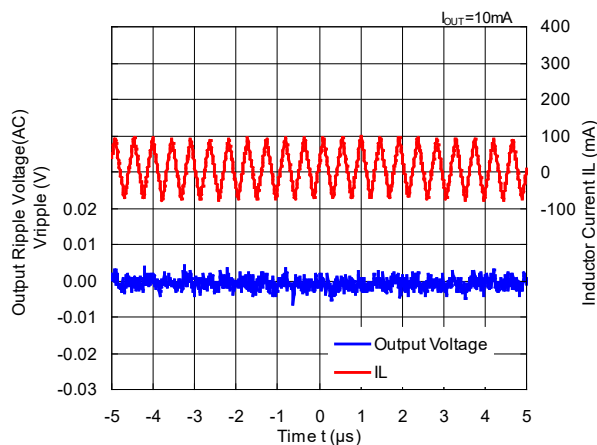

RP506Lxx1G/H/N $V_{OUT} = 3.3\text{ V}$ ($V_{IN} = 5.0\text{ V}$)
 MODE = "L" PWM/VFM Auto Switching Control

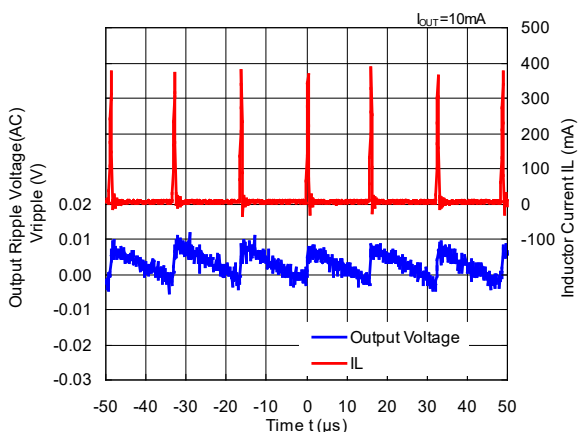

RP506Lxx1G/H/N $V_{OUT} = 1.8\text{ V}$ ($V_{IN} = 5.0\text{ V}$)
 MODE = "H" Forced PWM Control

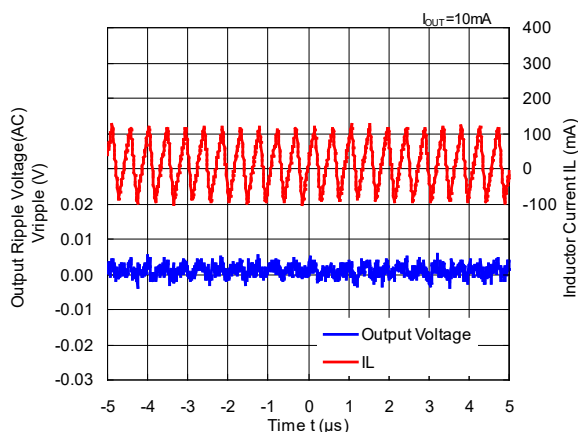

RP506Lxx1K/L/M $V_{OUT} = 0.6\text{ V}$ ($V_{IN} = 3.6\text{ V}$)
 MODE = "L" PWM/VFM Auto Switching Control

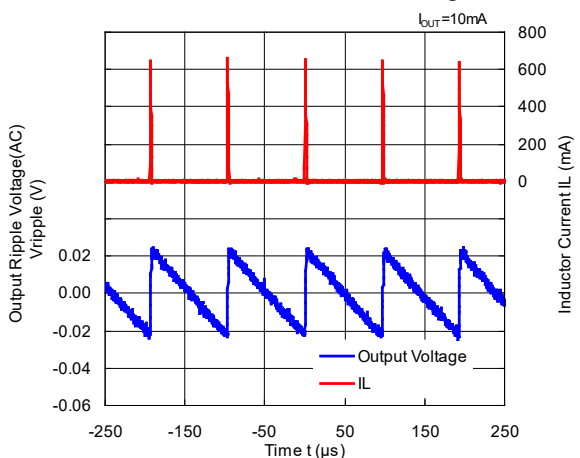

RP506Lxx1K/L/M $V_{OUT} = 0.6\text{ V}$ ($V_{IN} = 3.6\text{ V}$)
 MODE = "H" Forced PWM Control

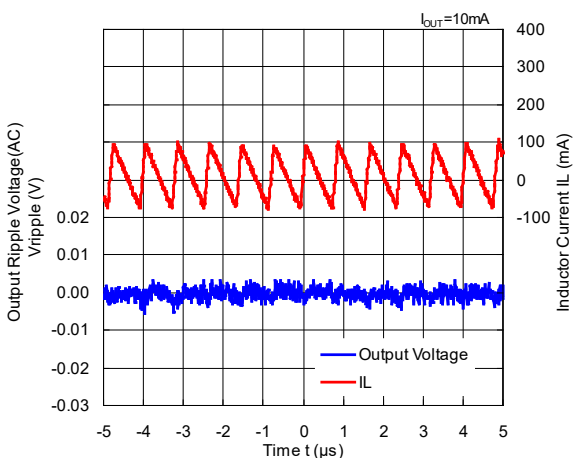

RP506L

No. EC-296-210909

RP506Lxx1K/L/M $V_{OUT} = 0.8\text{ V}$ ($V_{IN} = 3.6\text{ V}$)
MODE = "L" PWM/VFM Auto Switching Control

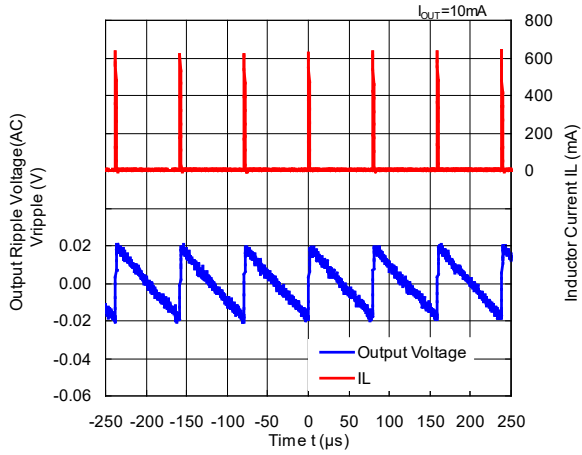

RP506Lxx1K/L/M $V_{OUT} = 0.8\text{ V}$ ($V_{IN} = 3.6\text{ V}$)
MODE = "H" Forced PWM Control

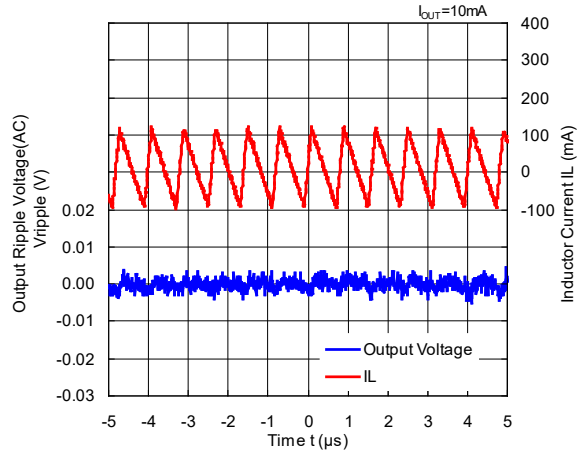

RP506Lxx1K/L/M $V_{OUT} = 1.2\text{ V}$ ($V_{IN} = 3.6\text{ V}$)
MODE = "L" PWM/VFM Auto Switching Control

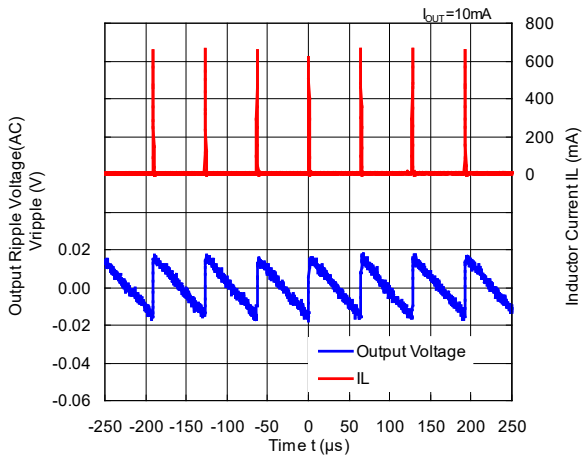

RP506Lxx1K/L/M $V_{OUT} = 1.2\text{ V}$ ($V_{IN} = 3.6\text{ V}$)
MODE = "H" Forced PWM Control

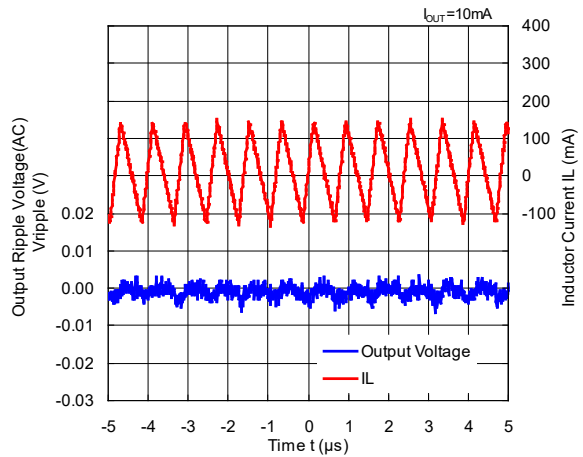

RP506Lxx1K/L/M $V_{OUT} = 1.8\text{ V}$ ($V_{IN} = 3.6\text{ V}$)
MODE = "L" PWM/VFM Auto Switching Control

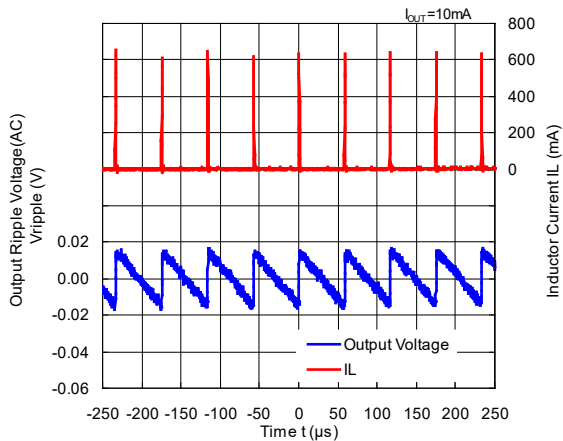

RP506Lxx1K/L/M $V_{OUT} = 1.8\text{ V}$ ($V_{IN} = 3.6\text{ V}$)
MODE = "H" Forced PWM Control

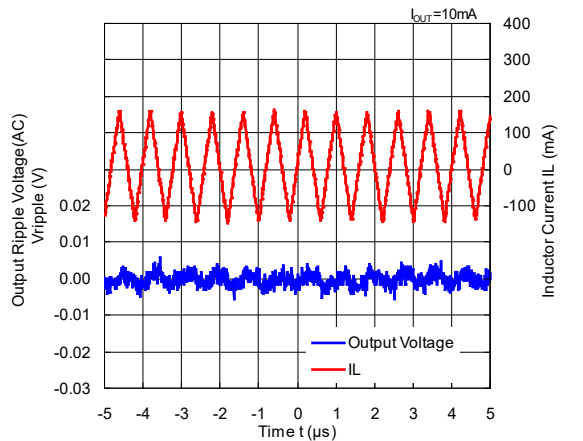

RP506Lxx1K/L/M $V_{OUT} = 3.3\text{ V}$ ($V_{IN} = 5.0\text{ V}$)
 MODE = "L" PWM/VFM Auto Switching Control

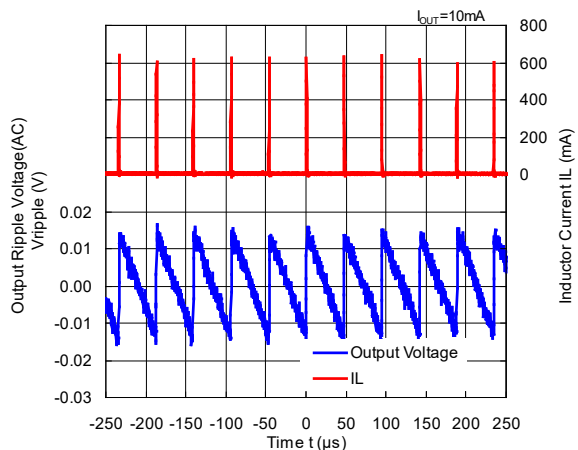

RP506Lxx1K/L/M $V_{OUT} = 3.3\text{ V}$ ($V_{IN} = 5.0\text{ V}$)
 MODE = "H" Forced PWM Control

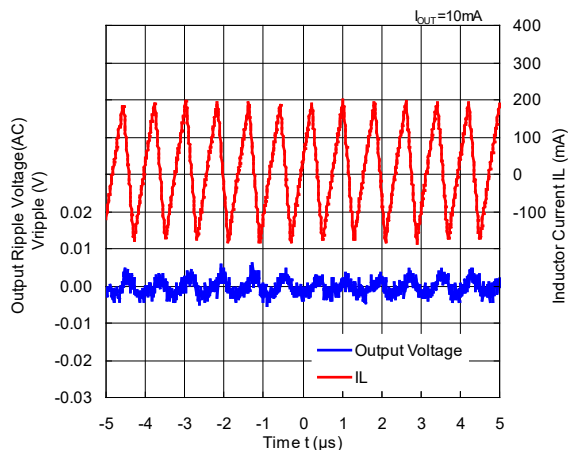

9) Oscillator Frequency vs. Ambient Temperature

RP506Lxx1G/H/N

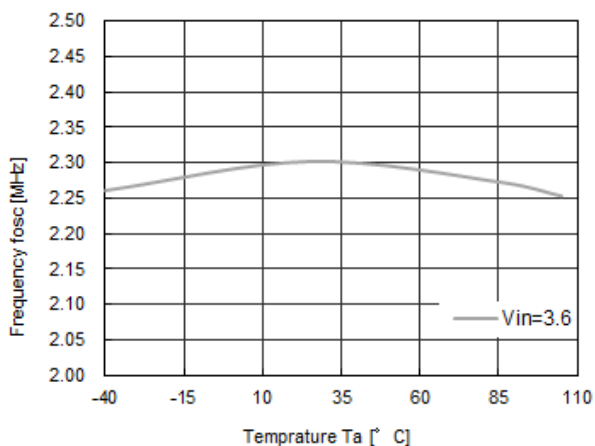

RP506Lxx1K/L/M

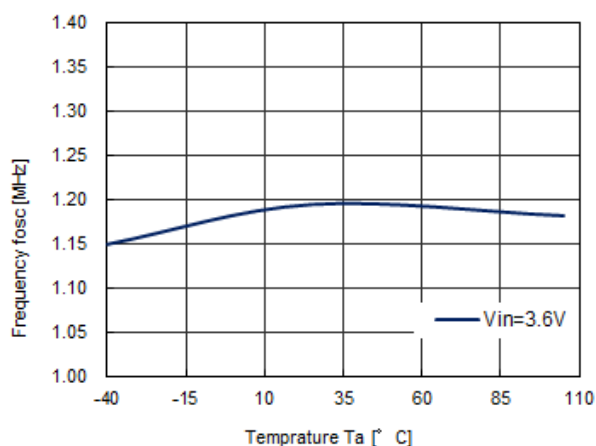

10) Oscillator Frequency vs. Input Voltage

RP506Lxx1G/H/N

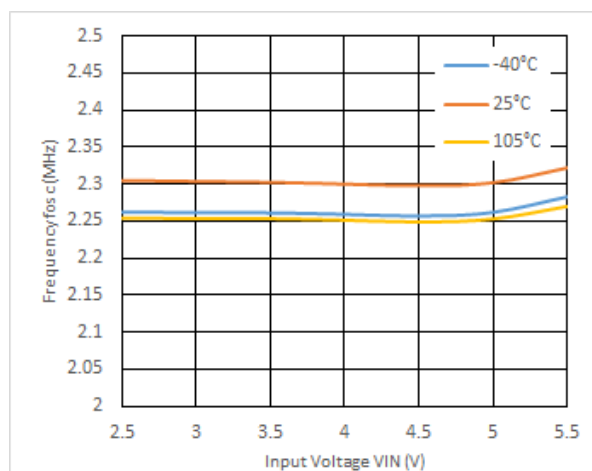

RP506Lxx1K/L/M

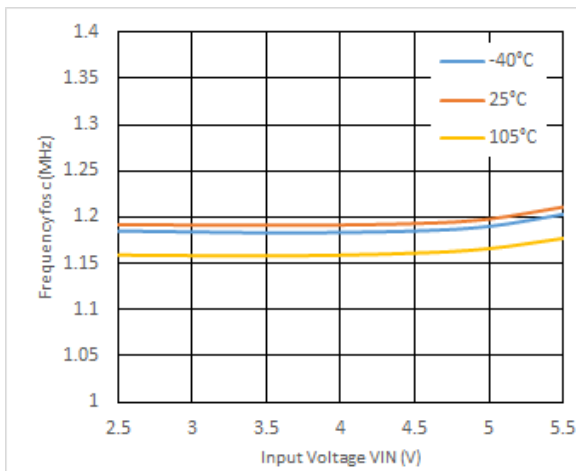

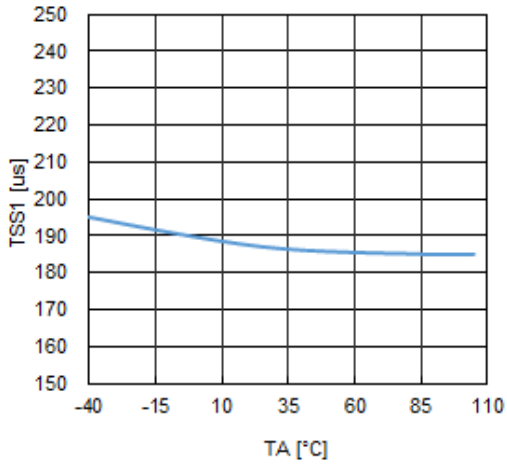
11) Soft-start Time vs. Ambient Temperature**12) UVLO Detector Threshold/ Released Voltage vs. Ambient Temperature**

UVLO Detector Threshold

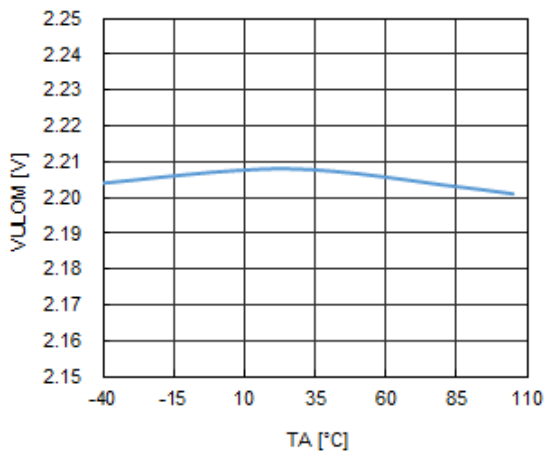

UVLO Released Voltage

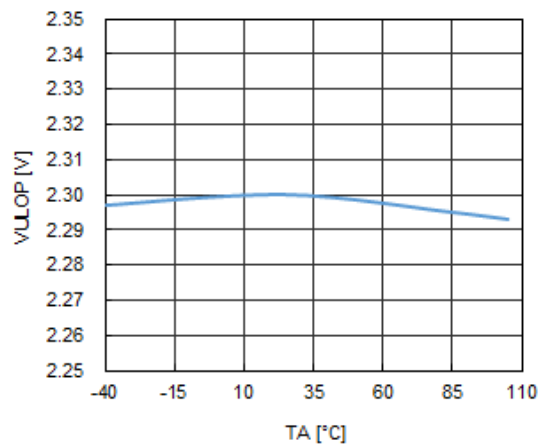
**13) CE Input Voltage vs. Ambient Temperature**

CE“H” Input Voltage (VIN = 5.5 V)

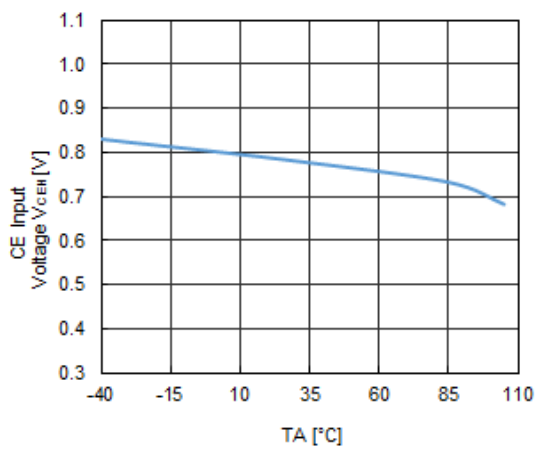

CE“L” Input Voltage (VIN = 2.5 V)

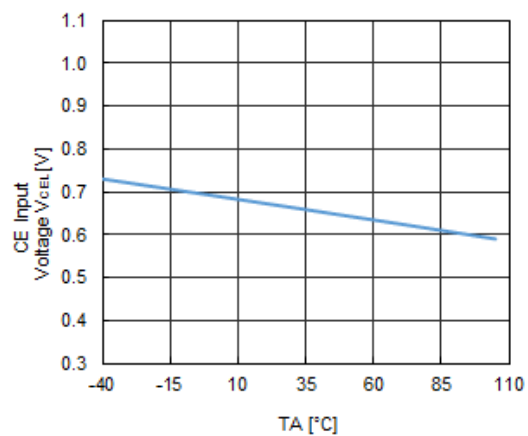

14) Lx Limit Current vs. Ambient Temperature

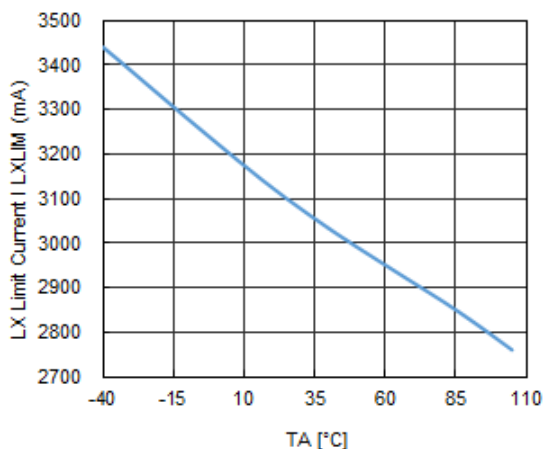

15) Nch Tr. On Resistance vs. Ambient Temperature 16) Pch Tr. On Resistance vs. Ambient Temperature

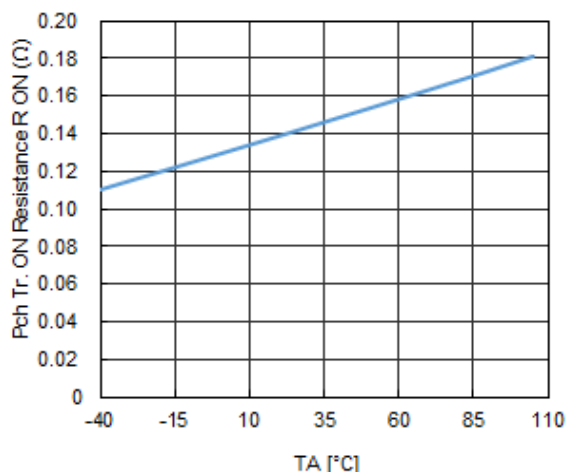
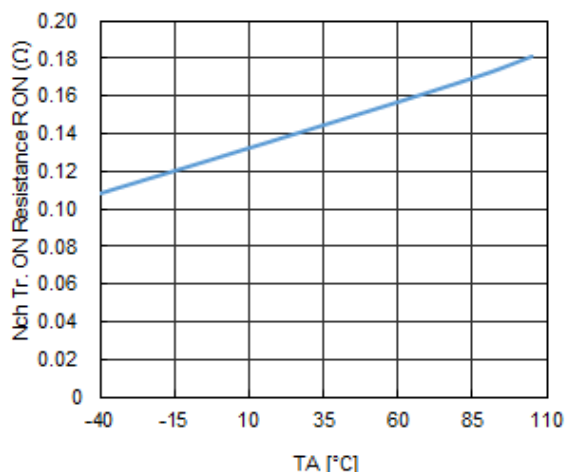

16) PG Detector Threshold vs. Ambient Temperature

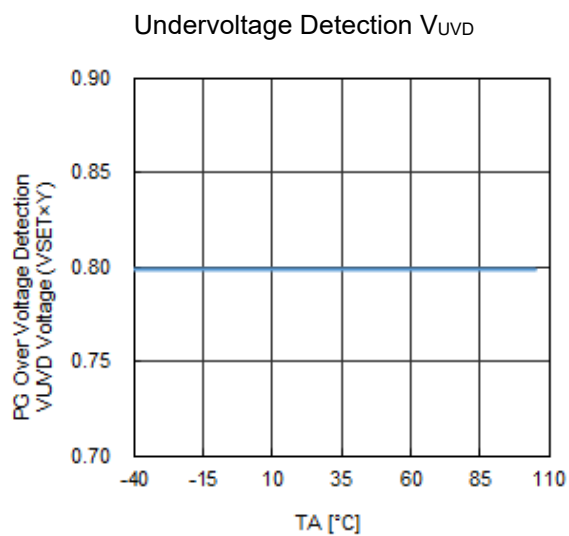
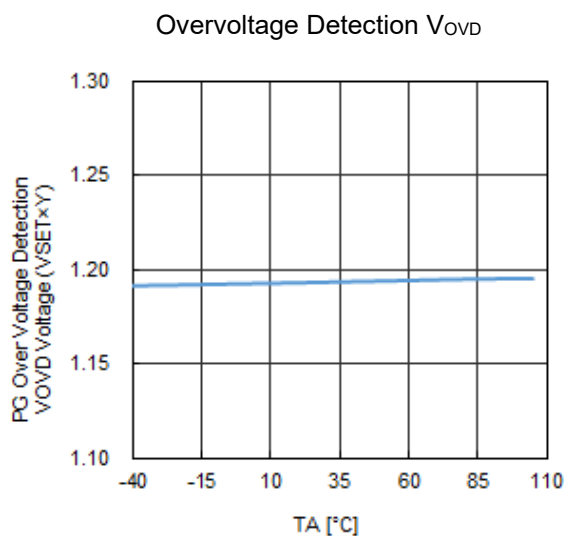

RP506L

No. EC-296-210909

18) Soft-start Waveform

RP506L $V_{OUT} = 1.8\text{ V}$, TSS = Open

RP506L $V_{OUT} = 1.8\text{ V}$, TSS = $0.1\ \mu\text{F}$

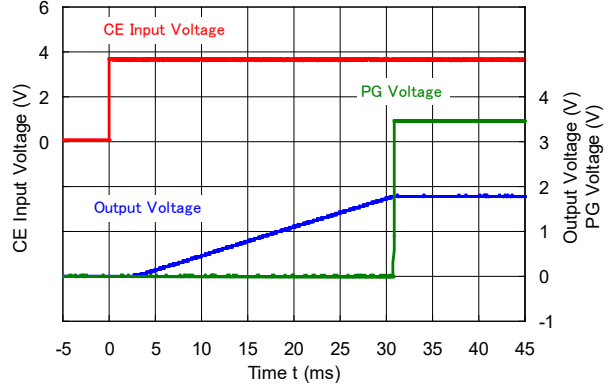
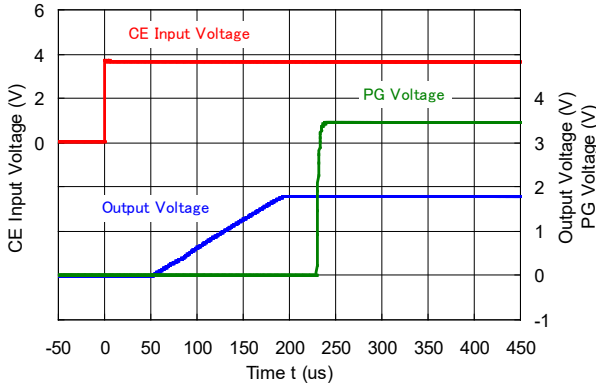

19) Load Transient Response

RP506Lxx1G/H/N ($V_{IN} = 3.6\text{ V}$, $V_{OUT} = 0.8\text{ V}$)

RP506Lxx1G/H/N ($V_{IN} = 3.6\text{ V}$, $V_{OUT} = 0.8\text{ V}$)

MODE = "L" PWM/VFM Auto Switching Control

MODE = "L" PWM/VFM Auto Switching Control

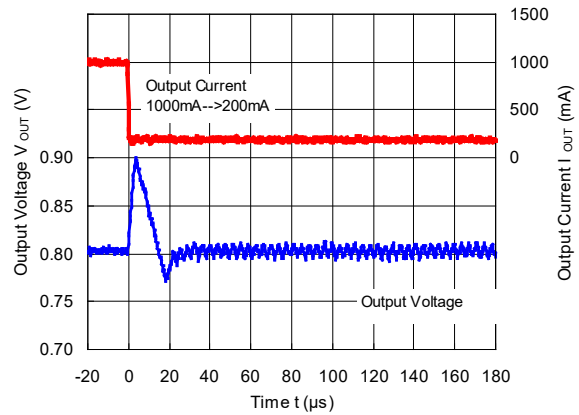
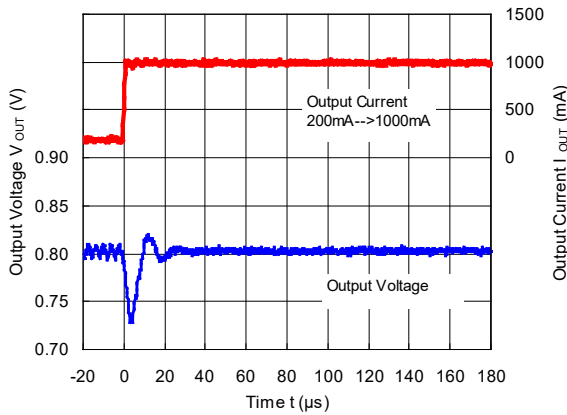

RP506Lxx1G/H/N ($V_{IN} = 3.6\text{ V}$, $V_{OUT} = 0.8\text{ V}$)

RP506Lxx1G/H/N ($V_{IN} = 3.6\text{ V}$, $V_{OUT} = 0.8\text{ V}$)

MODE = "L" PWM/VFM Auto Switching Control

MODE = "L" PWM/VFM Auto Switching Control

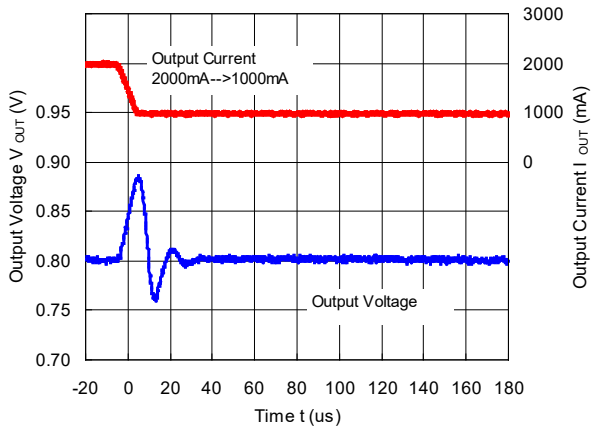
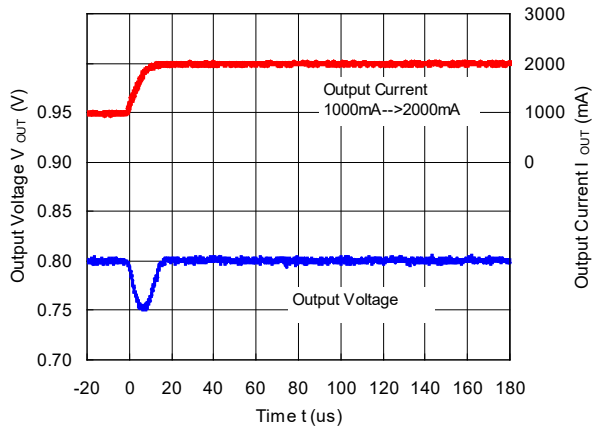

RP506Lxx1G/H/N ($V_{IN} = 3.6\text{ V}$, $V_{OUT} = 1.2\text{ V}$)
 MODE = "L" PWM/VFM Auto Switching Control

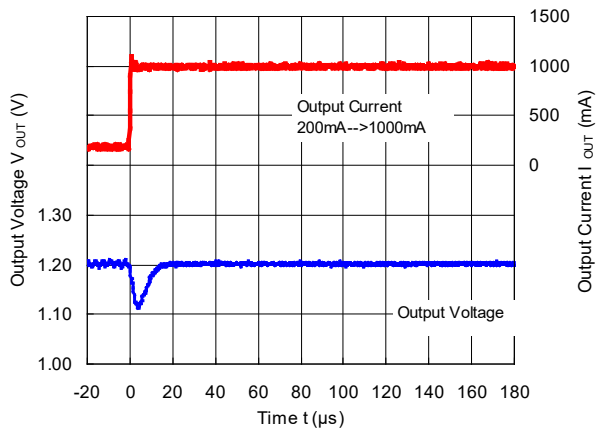

RP506Lxx1G/H/N ($V_{IN} = 3.6\text{ V}$, $V_{OUT} = 1.2\text{ V}$)
 MODE = "L" PWM/VFM Auto Switching Control

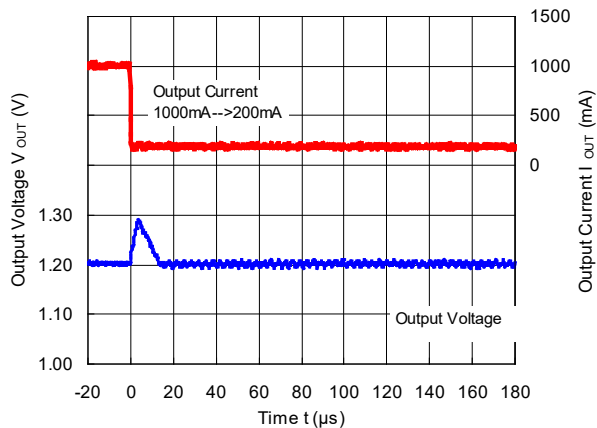

RP506Lxx1G/H/N ($V_{IN} = 3.6\text{ V}$, $V_{OUT} = 1.2\text{ V}$)
 MODE = "H" Forced PWM Control

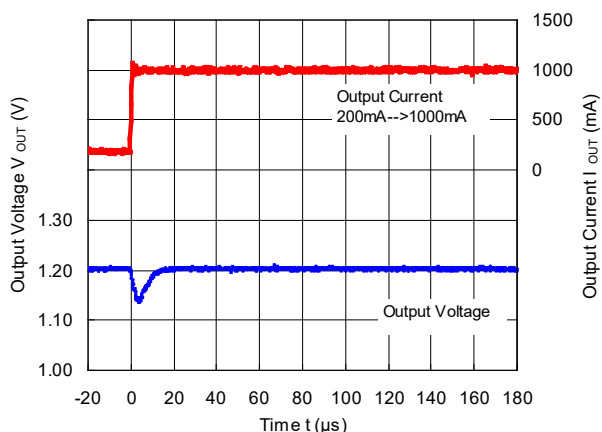

RP506Lxx1G/H/N ($V_{IN} = 3.6\text{ V}$, $V_{OUT} = 1.2\text{ V}$)
 MODE = "H" Forced PWM Control

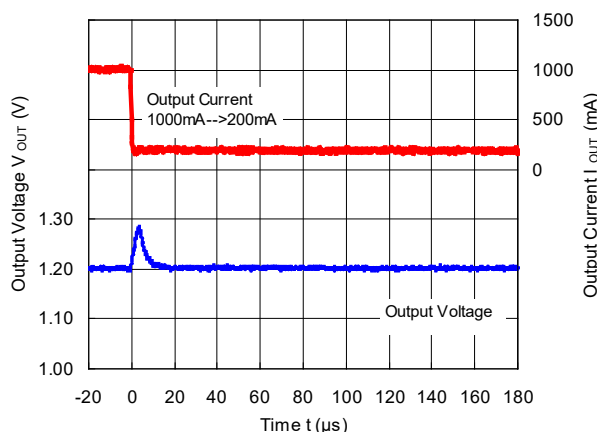

RP506Lxx1G/H/N ($V_{IN} = 3.6\text{ V}$, $V_{OUT} = 1.2\text{ V}$)

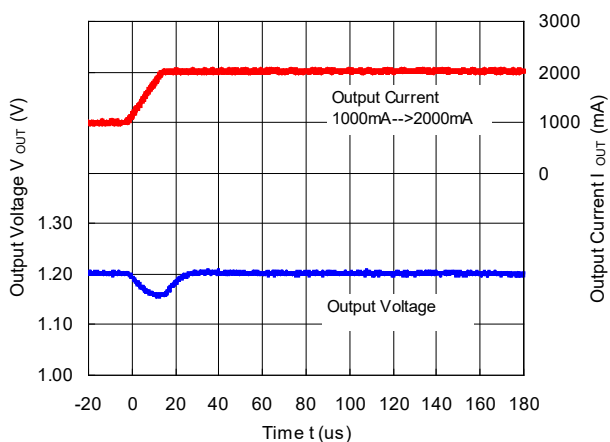

RP506Lxx1G/H/N ($V_{IN} = 3.6\text{ V}$, $V_{OUT} = 1.2\text{ V}$)

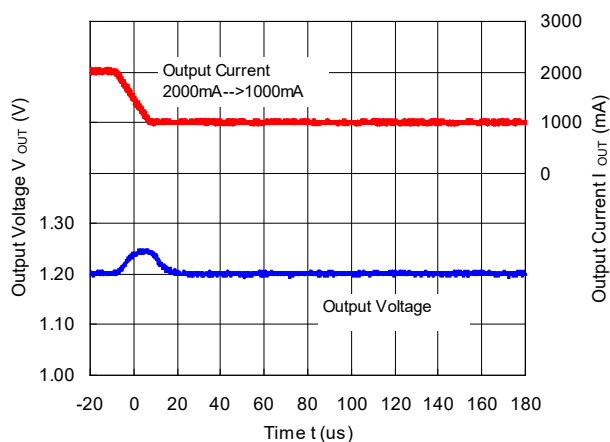

RP506L

No. EC-296-210909

RP506Lxx1G/H/N ($V_{IN} = 3.6\text{ V}$, $V_{OUT} = 1.8\text{ V}$)
MODE = "L" PWM/VFM Auto Switching Control

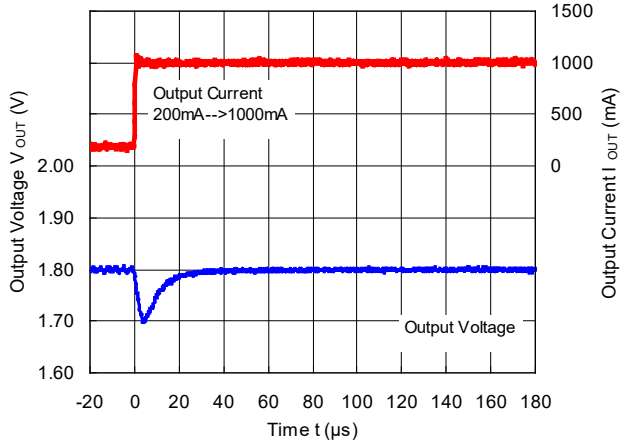

RP506Lxx1G/H/N ($V_{IN} = 3.6\text{ V}$, $V_{OUT} = 1.8\text{ V}$)
MODE = "L" PWM/VFM Auto Switching Control

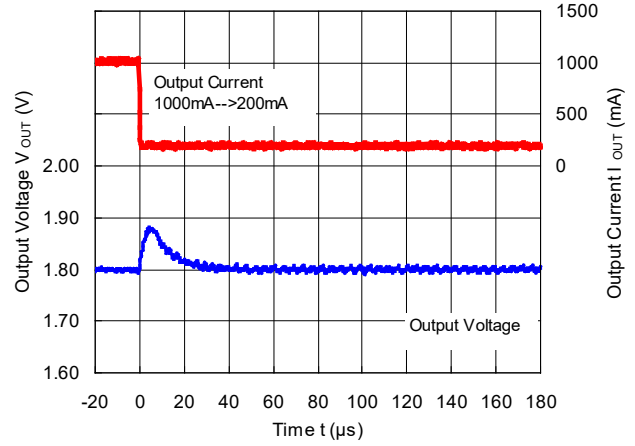

RP506Lxx1G/H/N ($V_{IN} = 3.6\text{ V}$, $V_{OUT} = 1.8\text{ V}$)
MODE = "H" Forced PWM Control

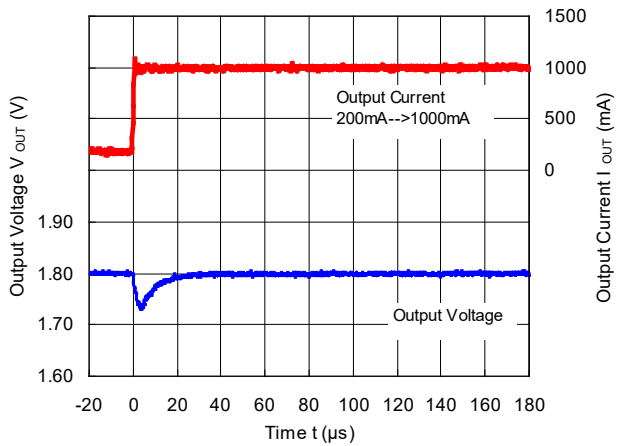

RP506Lxx1G/H/N ($V_{IN} = 3.6\text{ V}$, $V_{OUT} = 1.8\text{ V}$)
MODE = "H" Forced PWM Control

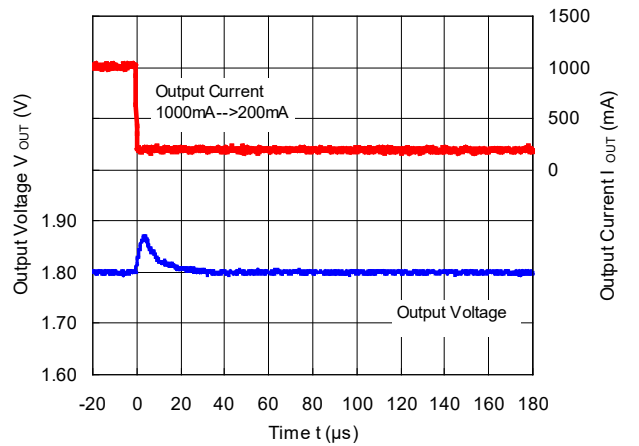

RP506Lxx1G/H/N ($V_{IN} = 3.6\text{ V}$, $V_{OUT} = 1.8\text{ V}$)

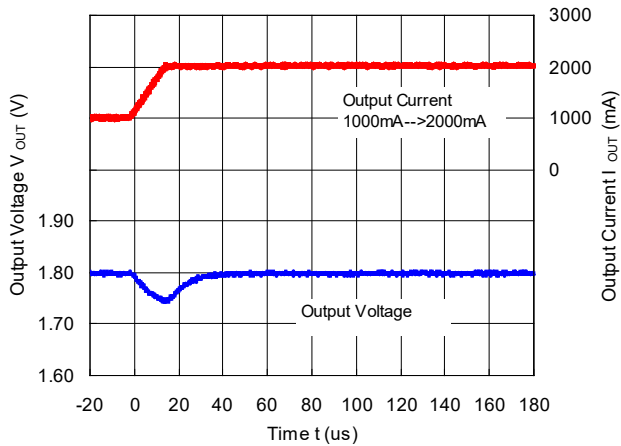

RP506Lxx1G/H/N ($V_{IN} = 3.6\text{ V}$, $V_{OUT} = 1.8\text{ V}$)

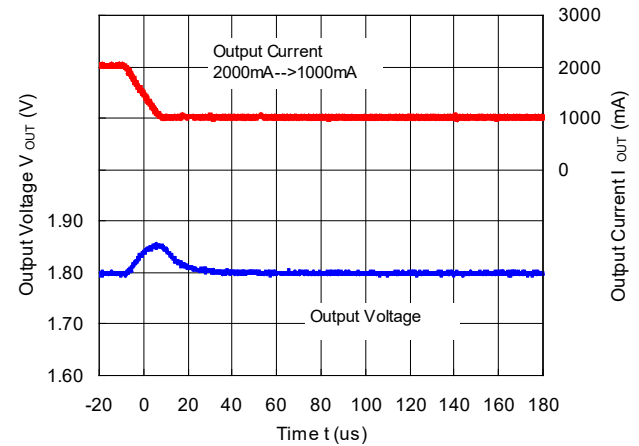

RP506Lxx1G/H/N ($V_{IN} = 5.0\text{ V}$, $V_{OUT} = 3.3\text{ V}$)
 MODE = "L" PWM/VFM Auto Switching Control

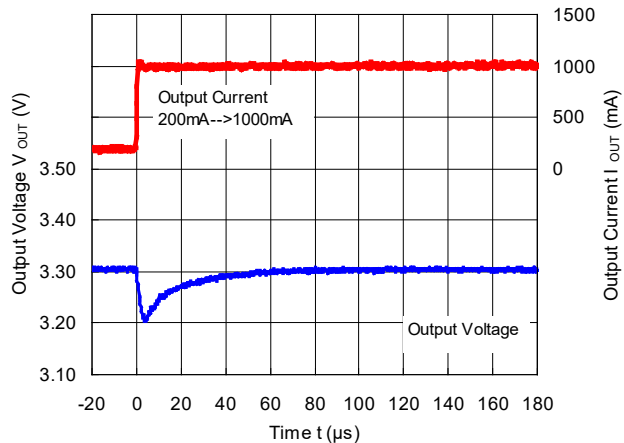

RP506Lxx1G/H/N ($V_{IN} = 5.0\text{ V}$, $V_{OUT} = 3.3\text{ V}$)
 MODE = "L" PWM/VFM Auto Switching Control

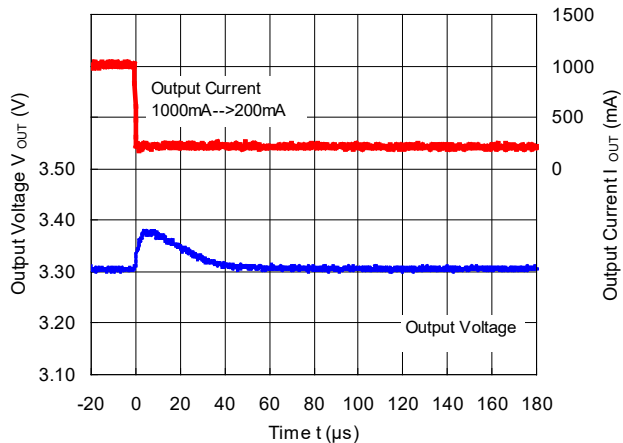

RP506Lxx1G/H/N ($V_{IN} = 5.0\text{ V}$, $V_{OUT} = 3.3\text{ V}$)
 MODE = "H" Forced PWM Control

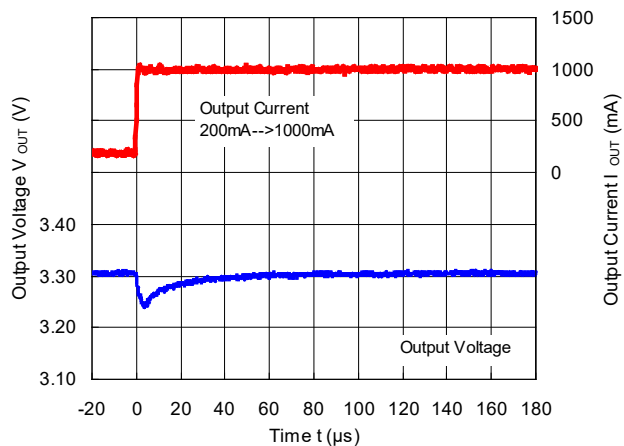

RP506Lxx1G/H/N ($V_{IN} = 5.0\text{ V}$, $V_{OUT} = 3.3\text{ V}$)
 MODE = "H" Forced PWM Control

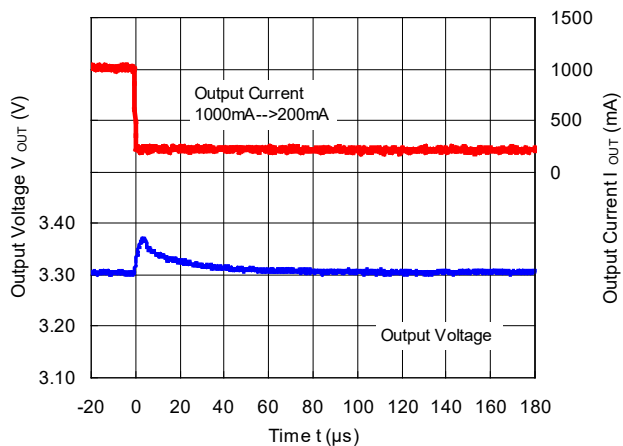

RP506Lxx1G/H/N ($V_{IN} = 5.0\text{ V}$, $V_{OUT} = 3.3\text{ V}$)

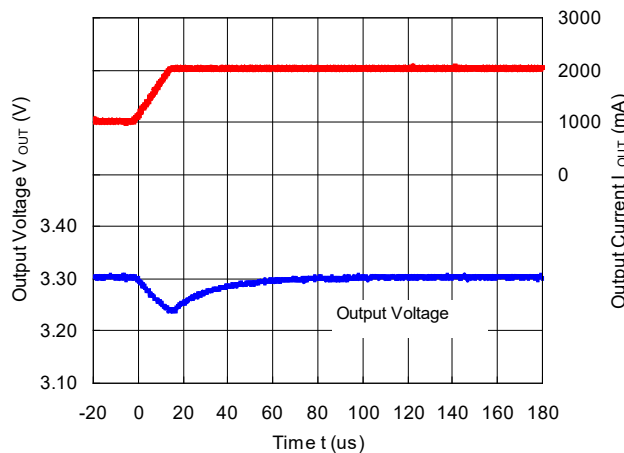

RP506Lxx1G/H/N ($V_{IN} = 5.0\text{ V}$, $V_{OUT} = 3.3\text{ V}$)

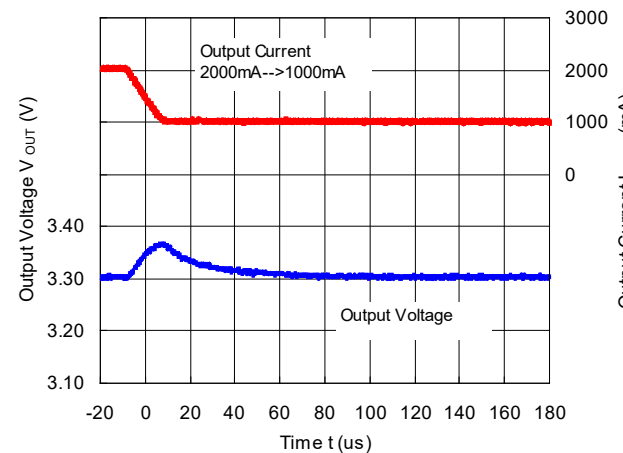

RP506L

No. EC-296-210909

RP506Lxx1K/L/M ($V_{IN} = 3.6\text{ V}$, $V_{OUT} = 0.6\text{ V}$)
MODE = "L" PWM/VFM Auto Switching Control

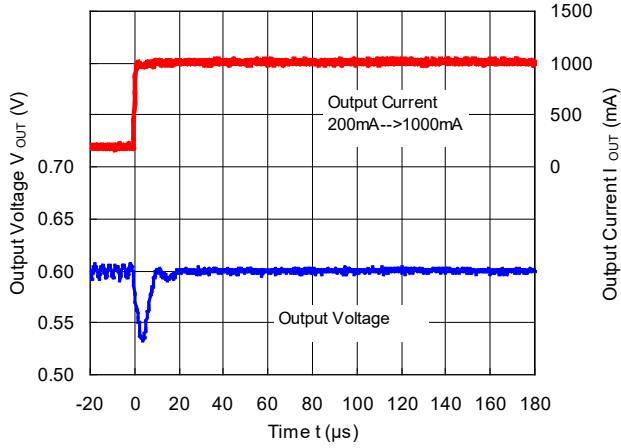

RP506Lxx1K/L/M ($V_{IN} = 3.6\text{ V}$, $V_{OUT} = 0.6\text{ V}$)
MODE = "L" PWM/VFM Auto Switching Control

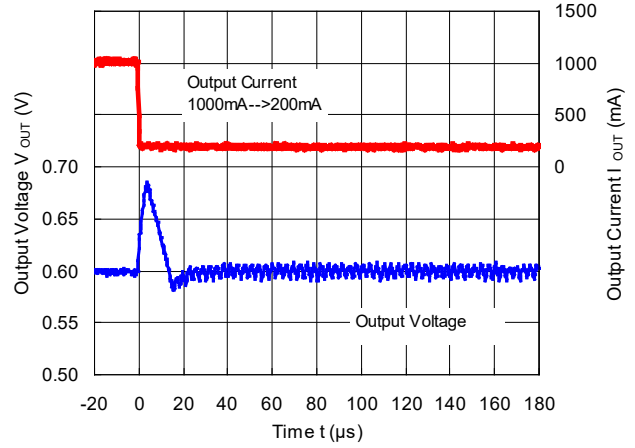

RP506Lxx1K/L/M ($V_{IN} = 3.6\text{ V}$, $V_{OUT} = 0.6\text{ V}$)
MODE = "H" Forced PWM Control

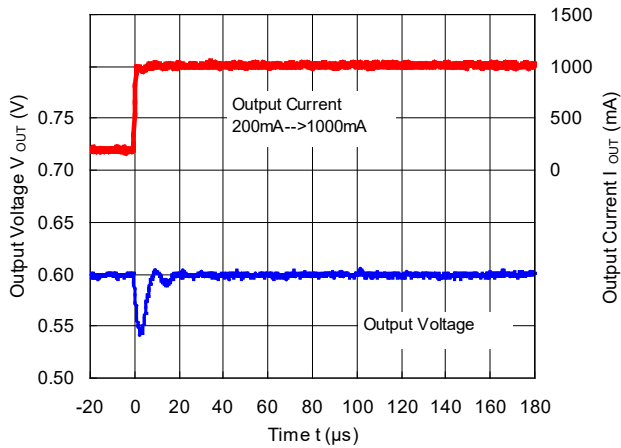

RP506Lxx1K/L/M ($V_{IN} = 3.6\text{ V}$, $V_{OUT} = 0.6\text{ V}$)
MODE = "H" Forced PWM Control

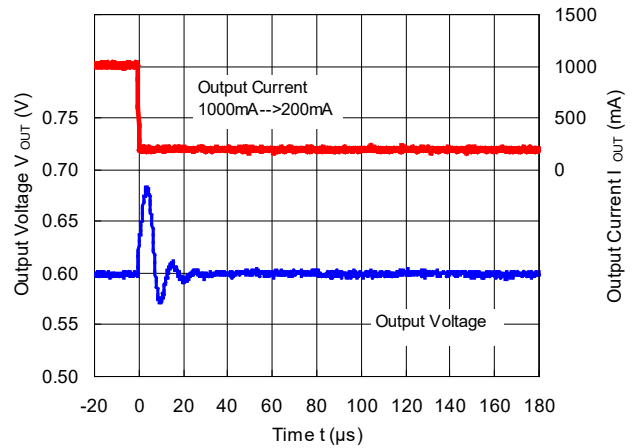

RP506Lxx1K/L/M ($V_{IN} = 3.6\text{ V}$, $V_{OUT} = 0.6\text{ V}$)

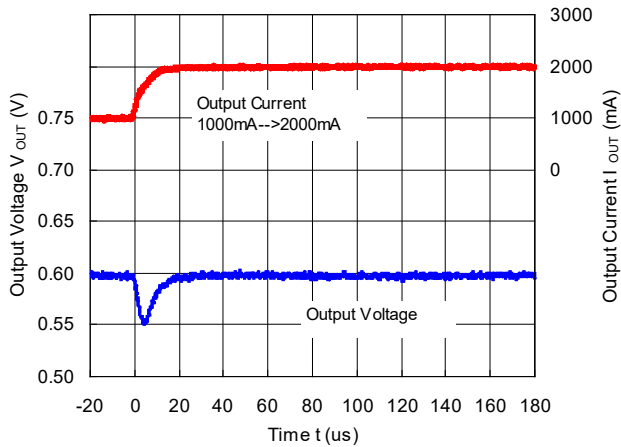

RP506Lxx1K/L/M ($V_{IN} = 3.6\text{ V}$, $V_{OUT} = 0.6\text{ V}$)

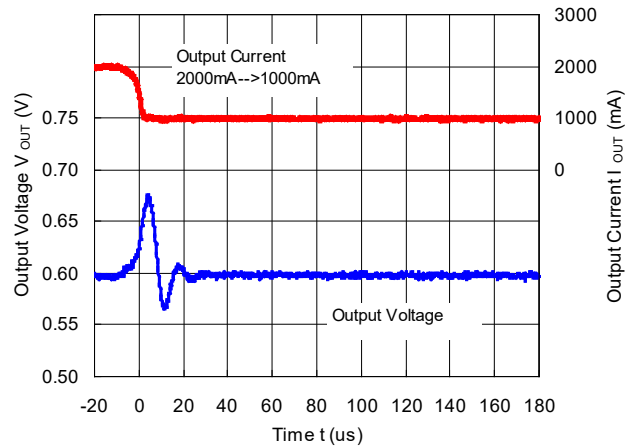

RP506Lxx1K/L/M ($V_{IN} = 3.6\text{ V}$, $V_{OUT} = 0.8\text{ V}$)
 MODE = "L" PWM/VFM Auto Switching Control

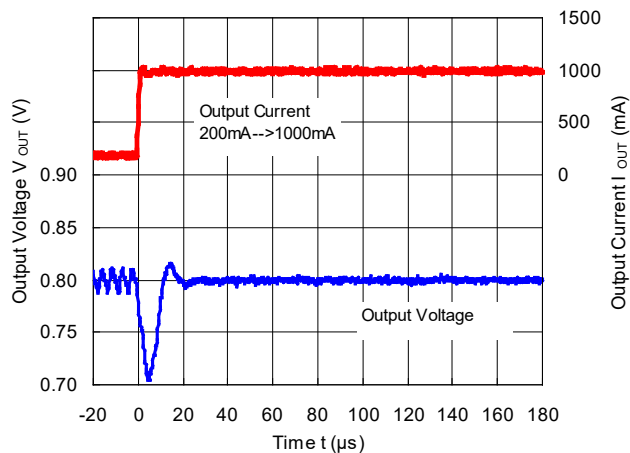

RP506Lxx1K/L/M ($V_{IN} = 3.6\text{ V}$, $V_{OUT} = 0.8\text{ V}$)
 MODE = "L" PWM/VFM Auto Switching Control

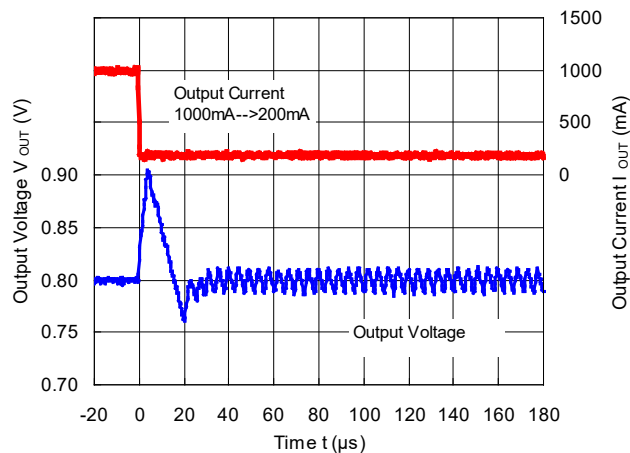

RP506Lxx1K/L/M ($V_{IN} = 3.6\text{ V}$, $V_{OUT} = 0.8\text{ V}$)
 MODE = "H" Forced PWM Control

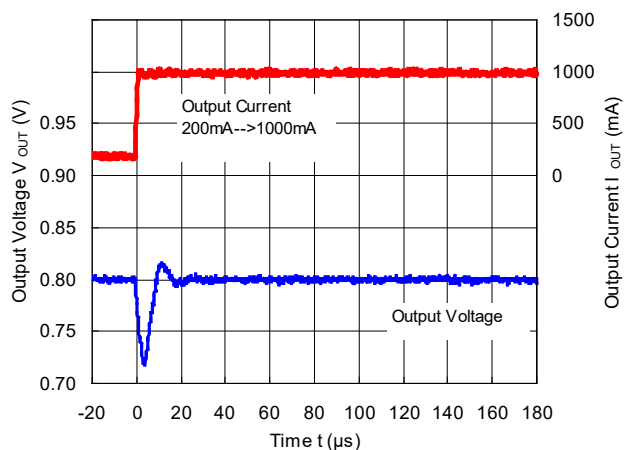

RP506Lxx1K/L/M ($V_{IN} = 3.6\text{ V}$, $V_{OUT} = 0.8\text{ V}$)
 MODE = "H" Forced PWM Control

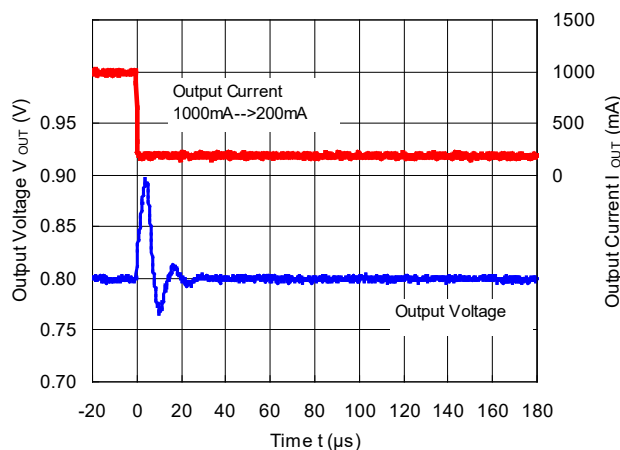

RP506Lxx1K/L/M ($V_{IN} = 3.6\text{ V}$, $V_{OUT} = 0.8\text{ V}$)

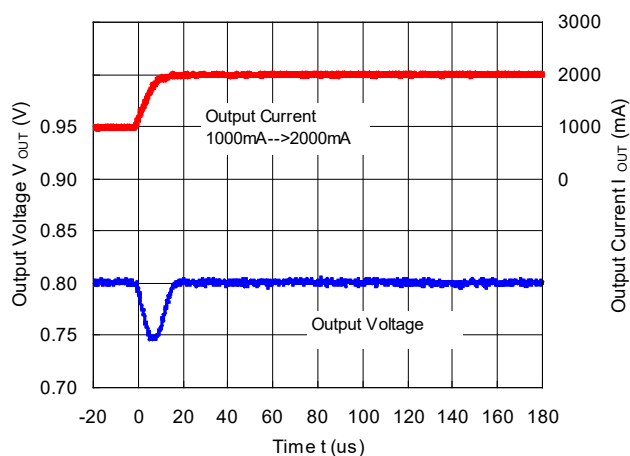

RP506Lxx1K/L/M ($V_{IN} = 3.6\text{ V}$, $V_{OUT} = 0.8\text{ V}$)

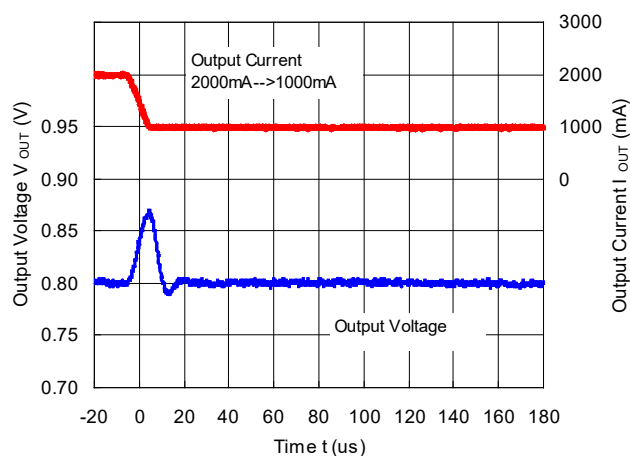

RP506L

No. EC-296-210909

RP506Lxx1K/L/M ($V_{IN} = 3.6\text{ V}$, $V_{OUT} = 1.2\text{ V}$)
MODE = "L" PWM/VFM Auto Switching Control

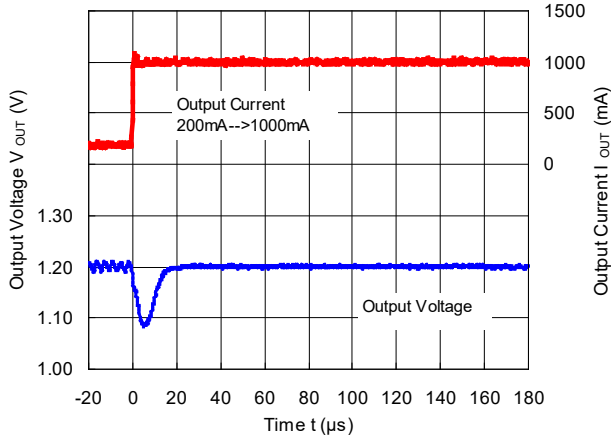

RP506Lxx1K/L/M ($V_{IN} = 3.6\text{ V}$, $V_{OUT} = 1.2\text{ V}$)
MODE = "L" PWM/VFM Auto Switching Control

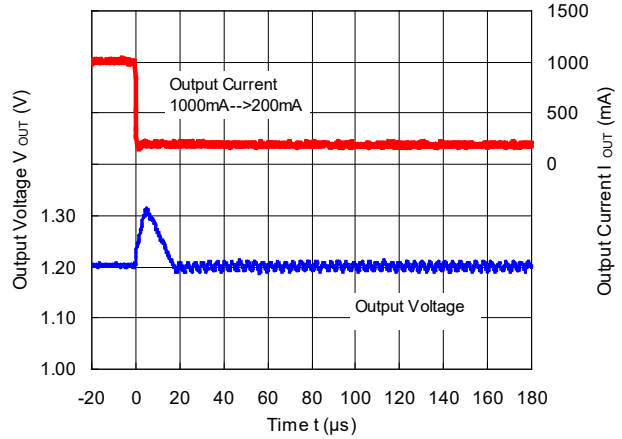

RP506Lxx1K/L/M ($V_{IN} = 3.6\text{ V}$, $V_{OUT} = 1.2\text{ V}$)
MODE = "H" Forced PWM Control

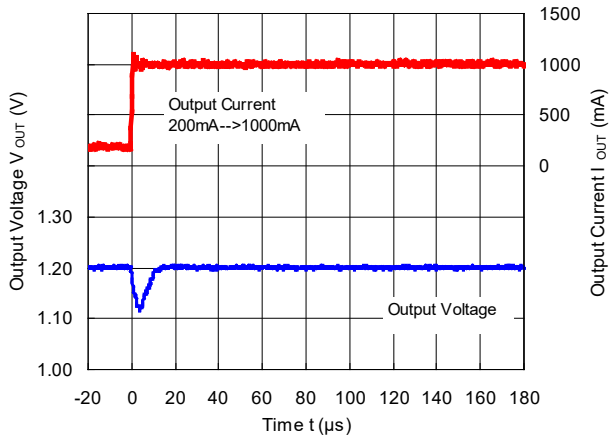

RP506Lxx1K/L/M ($V_{IN} = 3.6\text{ V}$, $V_{OUT} = 1.2\text{ V}$)
MODE = "H" Forced PWM Control

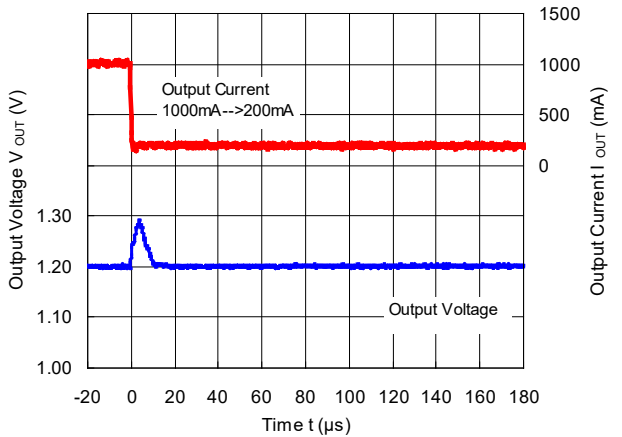

RP506Lxx1K/L/M ($V_{IN} = 3.6\text{ V}$, $V_{OUT} = 1.2\text{ V}$)

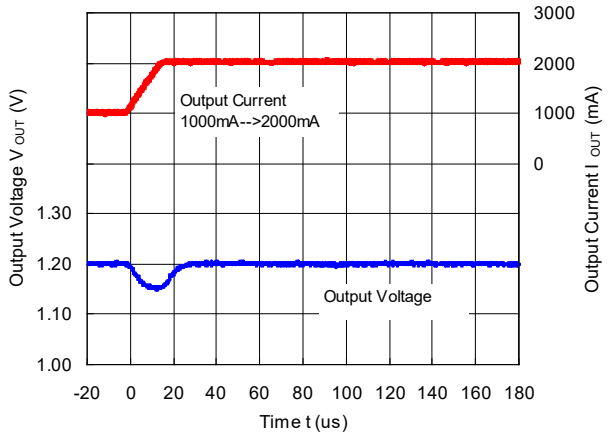

RP506Lxx1K/L/M ($V_{IN} = 3.6\text{ V}$, $V_{OUT} = 1.2\text{ V}$)

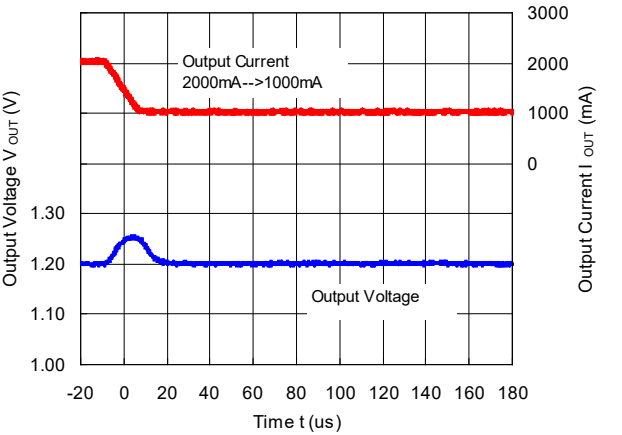

RP506Lxx1K/L/M ($V_{IN} = 3.6\text{ V}$, $V_{OUT} = 1.8\text{ V}$)
 MODE = "L" PWM/VFM Auto Switching Control

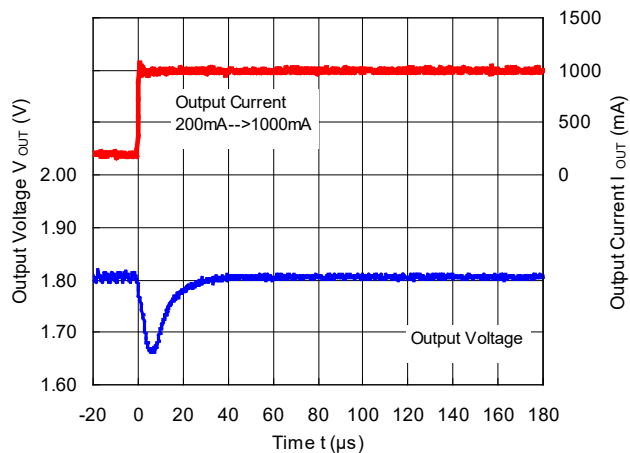

RP506Lxx1K/L/M ($V_{IN} = 3.6\text{ V}$, $V_{OUT} = 1.8\text{ V}$)
 MODE = "L" PWM/VFM Auto Switching Control

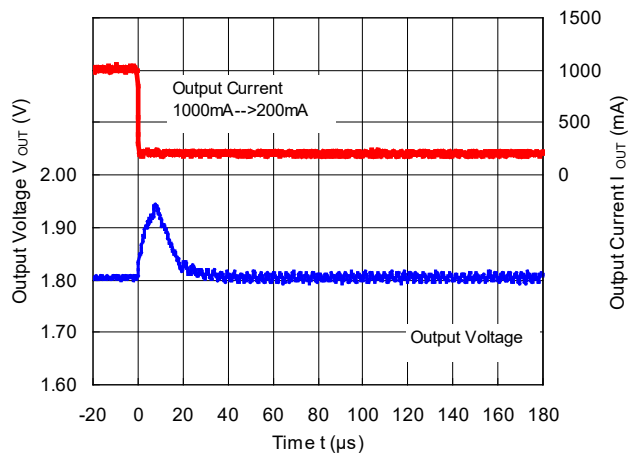

RP506Lxx1K/L/M ($V_{IN} = 3.6\text{ V}$, $V_{OUT} = 1.8\text{ V}$)
 MODE = "H" Forced PWM Control

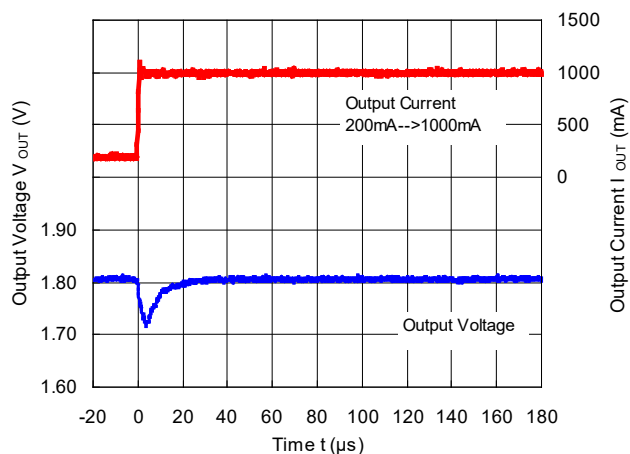

RP506Lxx1K/L/M ($V_{IN} = 3.6\text{ V}$, $V_{OUT} = 1.8\text{ V}$)
 MODE = "H" Forced PWM Control

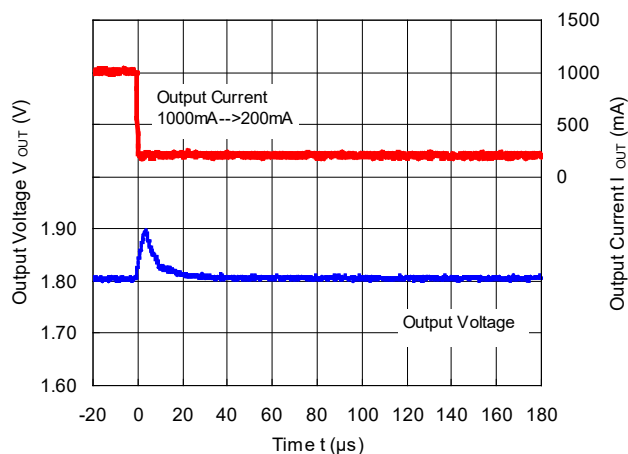

RP506Lxx1K/L/M ($V_{IN} = 3.6\text{ V}$, $V_{OUT} = 1.8\text{ V}$)

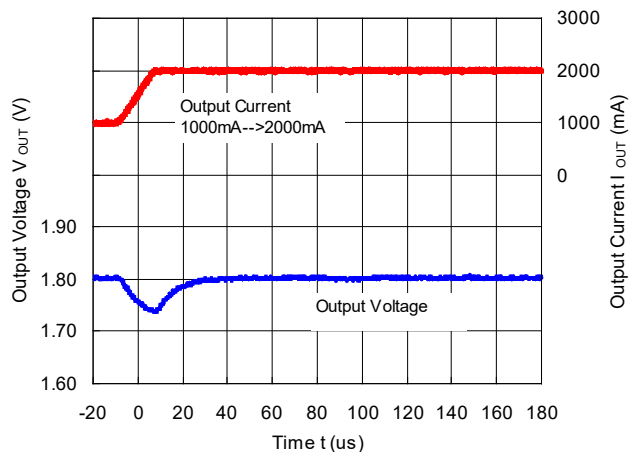

RP506Lxx1K/L/M ($V_{IN} = 3.6\text{ V}$, $V_{OUT} = 1.8\text{ V}$)

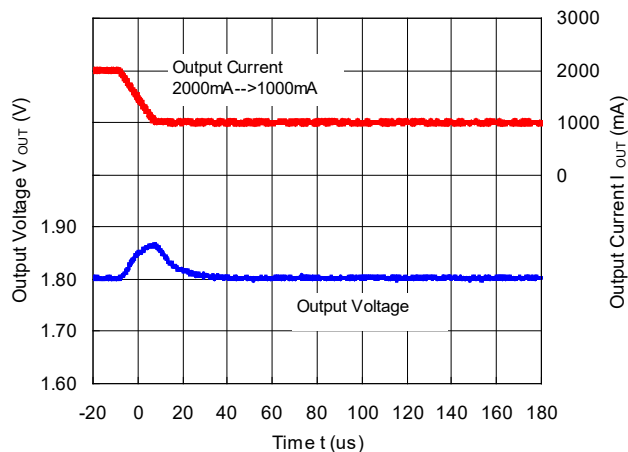

RP506L

No. EC-296-210909

RP506Lxx1K/L/M ($V_{IN} = 5.0\text{ V}$, $V_{OUT} = 3.3\text{ V}$)
MODE = "L" PWM/VFM Auto Switching Control

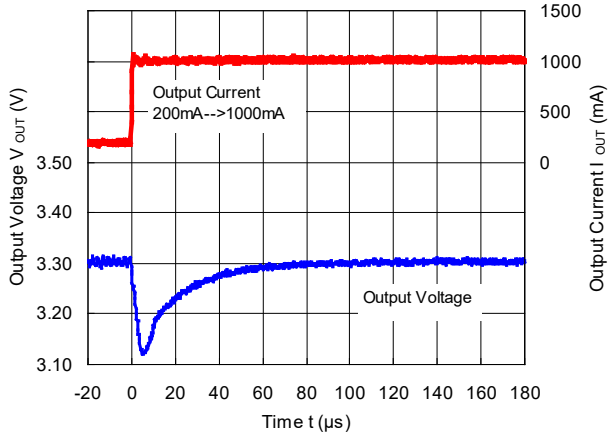

RP506Lxx1K/L/M ($V_{IN} = 5.0\text{ V}$, $V_{OUT} = 3.3\text{ V}$)
MODE = "L" PWM/VFM Auto Switching Control

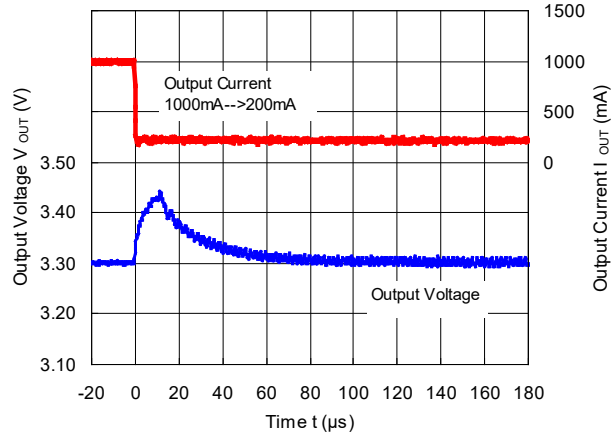

RP506Lxx1K/L/M ($V_{IN} = 5.0\text{ V}$, $V_{OUT} = 3.3\text{ V}$)
MODE = "H" Forced PWM Control

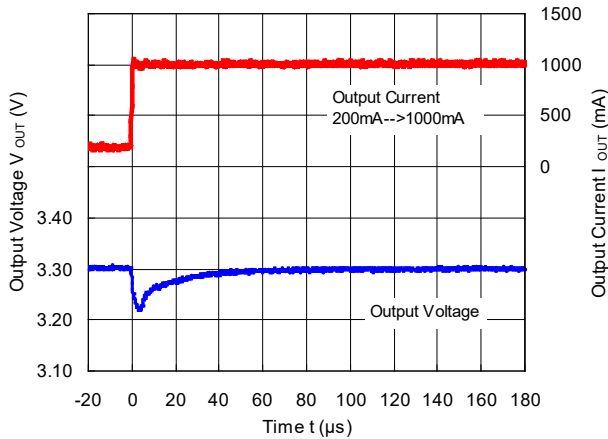

RP506Lxx1K/L/M ($V_{IN} = 5.0\text{ V}$, $V_{OUT} = 3.3\text{ V}$)
MODE = "H" Forced PWM Control

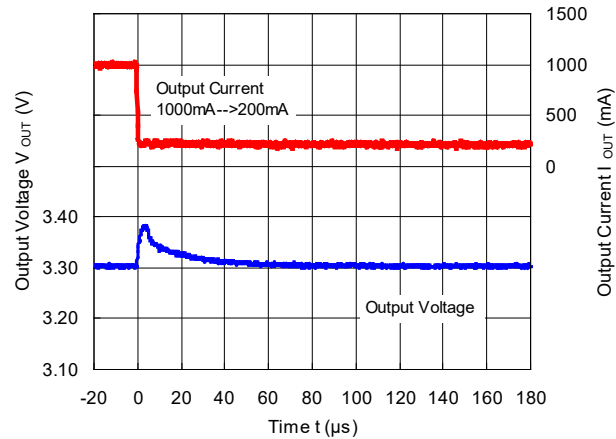

RP506Lxx1K/L/M ($V_{IN} = 5.0\text{ V}$, $V_{OUT} = 3.3\text{ V}$)

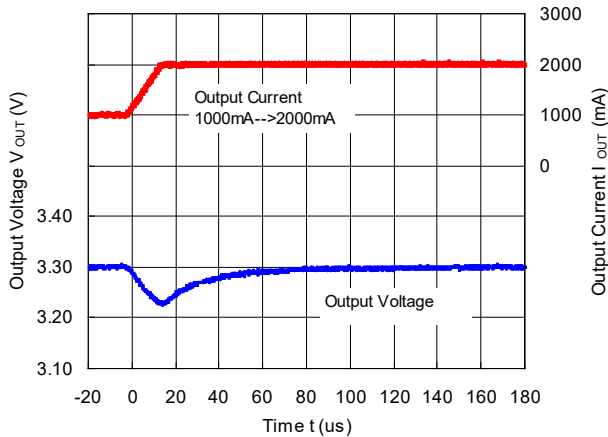

RP506Lxx1K/L/M ($V_{IN} = 5.0\text{ V}$, $V_{OUT} = 3.3\text{ V}$)

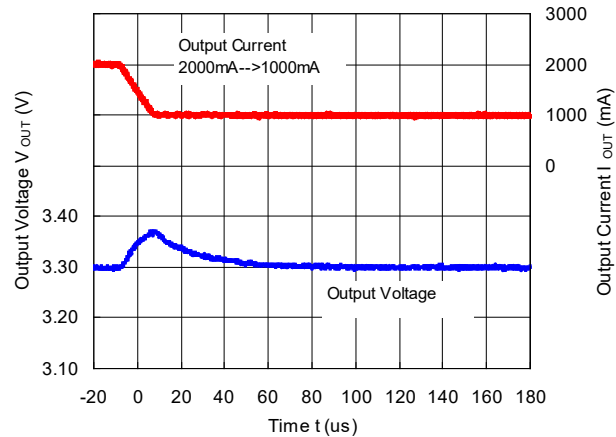

20) Auto Switching Control Waveform

RP506Lxx1G/H/N ($V_{IN} = 3.6\text{ V}$, $V_{OUT} = 1.2\text{ V}$, $I_{OUT} = 1\text{ mA}$)

MODE = "L" → MODE = "H"

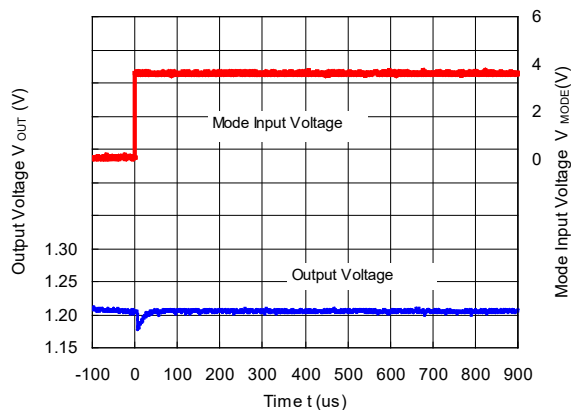

RP506Lxx1G/H/N ($V_{IN} = 3.6\text{ V}$, $V_{OUT} = 1.2\text{ V}$, $I_{OUT} = 1\text{ mA}$)

MODE = "H" → MODE = "L"

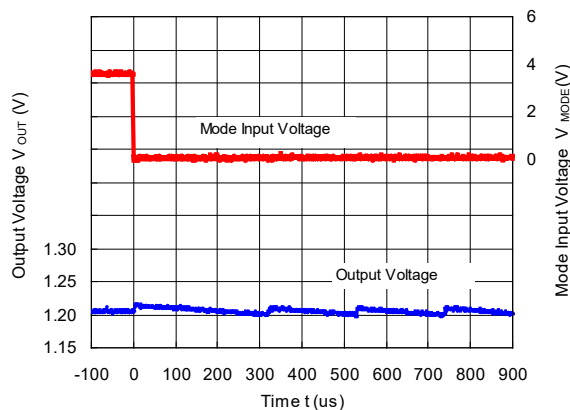

RP506Lxx1G/H/N ($V_{IN} = 3.6\text{ V}$, $V_{OUT} = 1.8\text{ V}$, $I_{OUT} = 1\text{ mA}$)

MODE = "L" → MODE = "H"

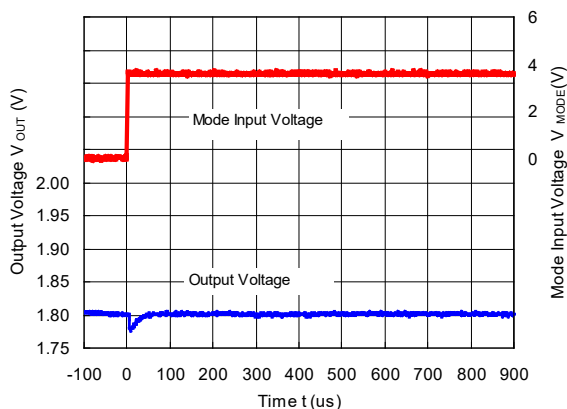

RP506Lxx1G/H/N ($V_{IN} = 3.6\text{ V}$, $V_{OUT} = 1.8\text{ V}$, $I_{OUT} = 1\text{ mA}$)

MODE = "H" → MODE = "L"

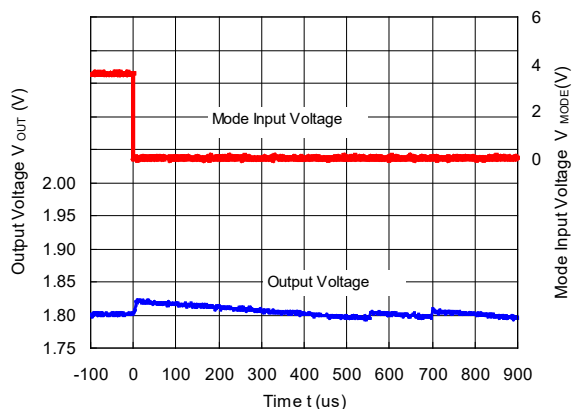

RP506Lxx1K/L/M ($V_{IN} = 3.6\text{ V}$, $V_{OUT} = 1.2\text{ V}$, $I_{OUT} = 1\text{ mA}$)

MODE = "L" → MODE = "H"

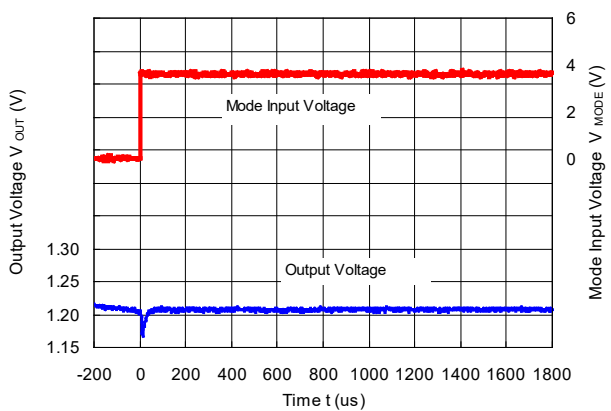

RP506Lxx1K/L/M ($V_{IN} = 3.6\text{ V}$, $V_{OUT} = 1.2\text{ V}$, $I_{OUT} = 1\text{ mA}$)

MODE = "H" → MODE = "L"

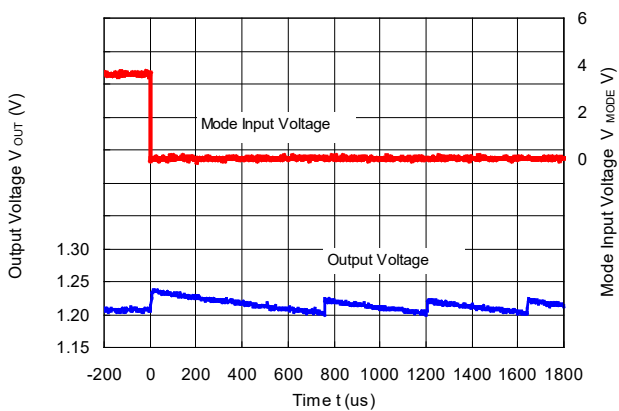

RP506L

No. EC-296-210909

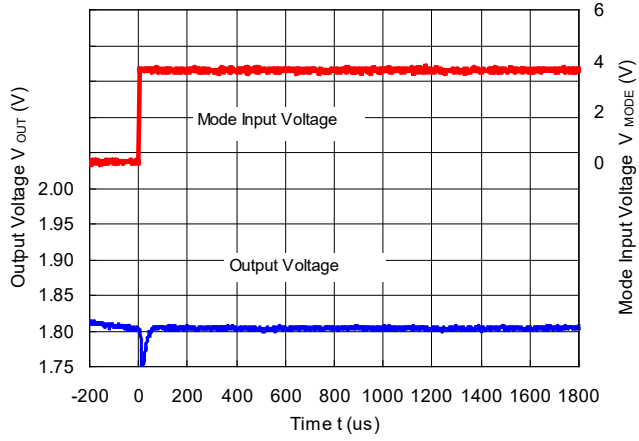
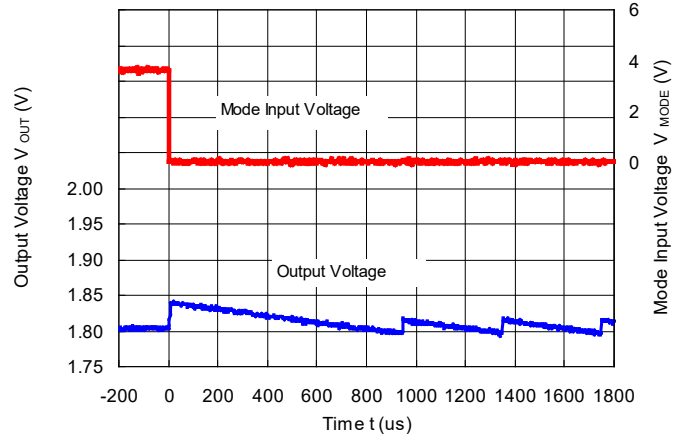
RP506Lxx1K/L/M ($V_{IN} = 3.6\text{ V}$, $V_{OUT} = 1.8\text{ V}$, $I_{OUT} = 1\text{ mA}$)
MODE = "L" → MODE = "H"RP506Lxx1K/L/M ($V_{IN} = 3.6\text{ V}$, $V_{OUT} = 1.8\text{ V}$, $I_{OUT} = 1\text{ mA}$)
MODE = "H" → MODE = "L"

The power dissipation of the package is dependent on PCB material, layout, and environmental conditions. The following measurement conditions are based on JEDEC STD. 51-7.

Measurement Conditions

Item	Measurement Conditions
Environment	Mounting on Board (Wind Velocity = 0 m/s)
Board Material	Glass Cloth Epoxy Plastic (Four-Layer Board)
Board Dimensions	76.2 mm × 114.3 mm × 0.8 mm
Copper Ratio	Outer Layer (First Layer): Less than 95% of 50 mm Square Inner Layers (Second and Third Layers): Approx. 100% of 50 mm Square Outer Layer (Fourth Layer): Approx. 100% of 50 mm Square
Through-holes	φ 0.3 mm × 32 pcs

Measurement Result

(Ta = 25°C, Tjmax = 150°C)

Item	Measurement Result
Power Dissipation	4300 mW
Thermal Resistance (θja)	θja = 29°C/W
Thermal Characterization Parameter (ψjt)	ψjt = 3.1°C/W

θja: Junction-to-Ambient Thermal Resistance

ψjt: Junction-to-Top Thermal Characterization Parameter

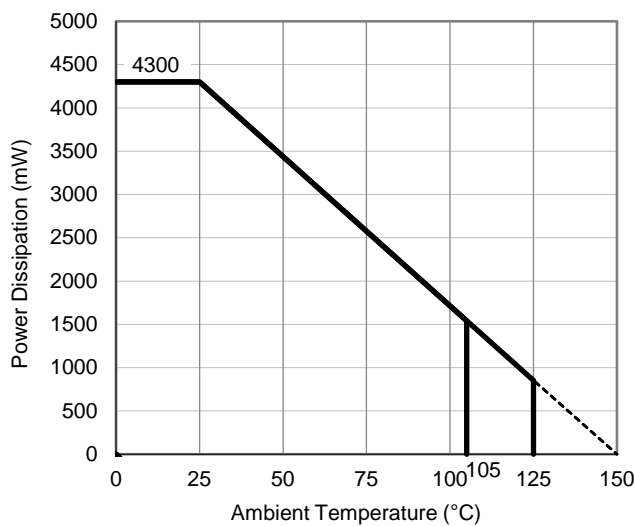

Power Dissipation vs. Ambient Temperature

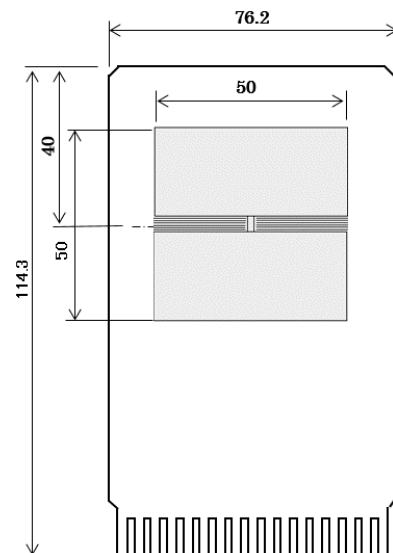

Measurement Board Pattern

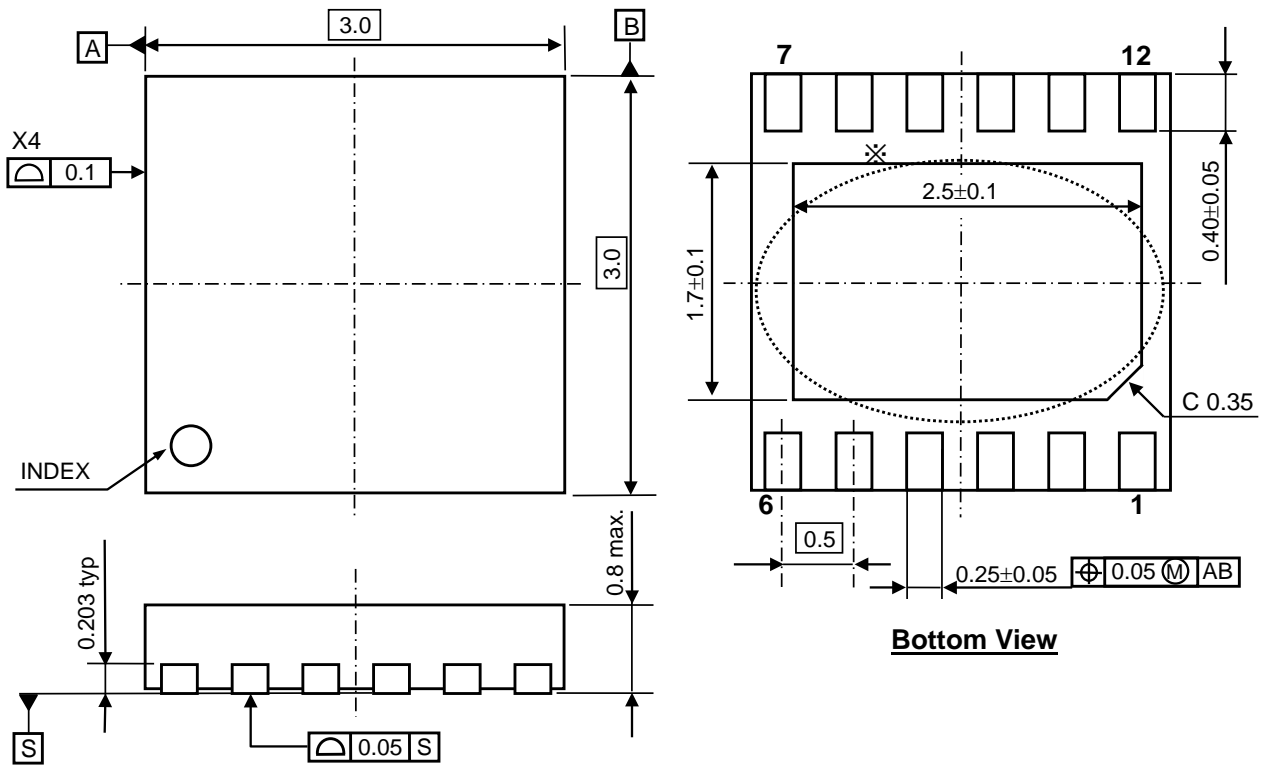

DFN3030-12 Package Dimensions (Unit: mm)

* The tab on the bottom of the package is substrate level (GND). It is recommended that the tab be connected to the ground plane on the board, or otherwise be left floating.



1. The products and the product specifications described in this document are subject to change or discontinuation of production without notice for reasons such as improvement. Therefore, before deciding to use the products, please refer to Ricoh sales representatives for the latest information thereon.
2. The materials in this document may not be copied or otherwise reproduced in whole or in part without prior written consent of Ricoh.
3. Please be sure to take any necessary formalities under relevant laws or regulations before exporting or otherwise taking out of your country the products or the technical information described herein.
4. The technical information described in this document shows typical characteristics of and example application circuits for the products. The release of such information is not to be construed as a warranty of or a grant of license under Ricoh's or any third party's intellectual property rights or any other rights.
5. The products in this document are designed for automotive applications. However, when using the products for automotive applications, please make sure to contact Ricoh sales representative in advance due to confirming the quality level.
6. We are making our continuous effort to improve the quality and reliability of our products, but semiconductor products are likely to fail with certain probability. In order to prevent any injury to persons or damages to property resulting from such failure, customers should be careful enough to incorporate safety measures in their design, such as redundancy feature, fire containment feature and fail-safe feature. We do not assume any liability or responsibility for any loss or damage arising from misuse or inappropriate use of the products.
7. Anti-radiation design is not implemented in the products described in this document.
8. The X-ray exposure can influence functions and characteristics of the products. Confirm the product functions and characteristics in the evaluation stage.
9. WLCSP products should be used in light shielded environments. The light exposure can influence functions and characteristics of the products under operation or storage.
10. There can be variation in the marking when different AOI (Automated Optical Inspection) equipment is used.
In the case of recognizing the marking characteristic with AOI, please contact Ricoh sales or our distributor before attempting to use AOI.
11. Please contact Ricoh sales representatives should you have any questions or comments concerning the products or the technical information.



Ricoh is committed to reducing the environmental loading materials in electrical devices with a view to contributing to the protection of human health and the environment.

Ricoh has been providing RoHS compliant products since April 1, 2006 and Halogen-free products since April 1, 2012.

RICOH RICOH ELECTRONIC DEVICES CO., LTD.

Official website

<https://www.n-redc.co.jp/en/>

Contact us

<https://www.n-redc.co.jp/en/buy/>

