

## HIGH EFFICIENCY, SMALL PACKAGES, STEP-UP DC/DC CONVERTERS

NO.EA-260-160812

### OUTLINE

RP401x Series are high efficiency, step-up DC/DC converter ICs packaged in compact 5pin SOT23-5 or 6pin DFN(PLP)1820-6. This IC can start up from low voltage (Typ.0.6V), therefore, it is suitable for using with single or 2 serial alkaline batteries, or a nickel-metal-hydrate (NiMH) battery, or one-cell Lithium-ion (Li+) battery.

This IC consists of an oscillator, a reference voltage unit with soft start, a chip enable circuit, an error amplifier, phase compensation circuits, a slope circuit, a PWM control circuit, a start-up circuit, a PWM/VFM mode control circuit, internal switches and a protection circuit.

A low ripple high efficiency step-up DC/DC converter can be composed of the RP401x with only an inductor, a diode, (resisters for adjustable type), and capacitors. The output voltage of the RP401K001s is adjustable, and others are fixed internally. The output voltage range is from 1.8V to 5.5V. RP401Kxx1A/B series have a MODE pin to alternate between PWM fix and PWM/VFM automatic shift to improve the efficiency at light load. If MODE pin is set "H", the mode is PWM fix, and when the MODE pin is set "L", PWM/VFM automatic shift. The RP401xxx1C and D do not have MODE pin. The RP401xxx1C is PWM/PFM alternative type, and the RP401xxx1D is PWM fixed type.

### FEATURES

- Low Start-up Voltage guaranteed.....Typ. 0.6V
- Input Voltage Range .....0.6V ~ 5.5V
- High Efficiency .....86% (100mA / 3.3V,  $V_{IN} = 1.5V$ , 25°C)
- Output current .....500mA / 1.8V ( $V_{IN} = 1.5V$ ) / 5.0V ( $V_{IN} = 3.3V$ )
- Built-in Lx switch.....NMOS: 0.4Ω ( $V_{OUT} = 3.3V$ , 25°C)
- PWM Oscillator Frequency.....1.2MHz
- Output Voltage Range.....Fixed type: 1.8V to 5.5V with 0.1V Stepwise  
Adjustable: 1.8V ~ 5.5V  
(Recommendation range of output voltage)
- Lx peak current limit function .....Typ. 1.0A
- Latch protection delay time.....3.3ms (Only applied to A version)
- Small Packages.....DFN(PLP)1820-6, SOT23-5

### APPLICATIONS

- MP3 players, PDA, cellular phones
- Digital Still Cameras
- LCD Bias Supplies
- Portable blood pressure meter
- Wireless Handset
- GPS

## BLOCK DIAGRAMS

### Fixed output; RP401Kxx1A/B

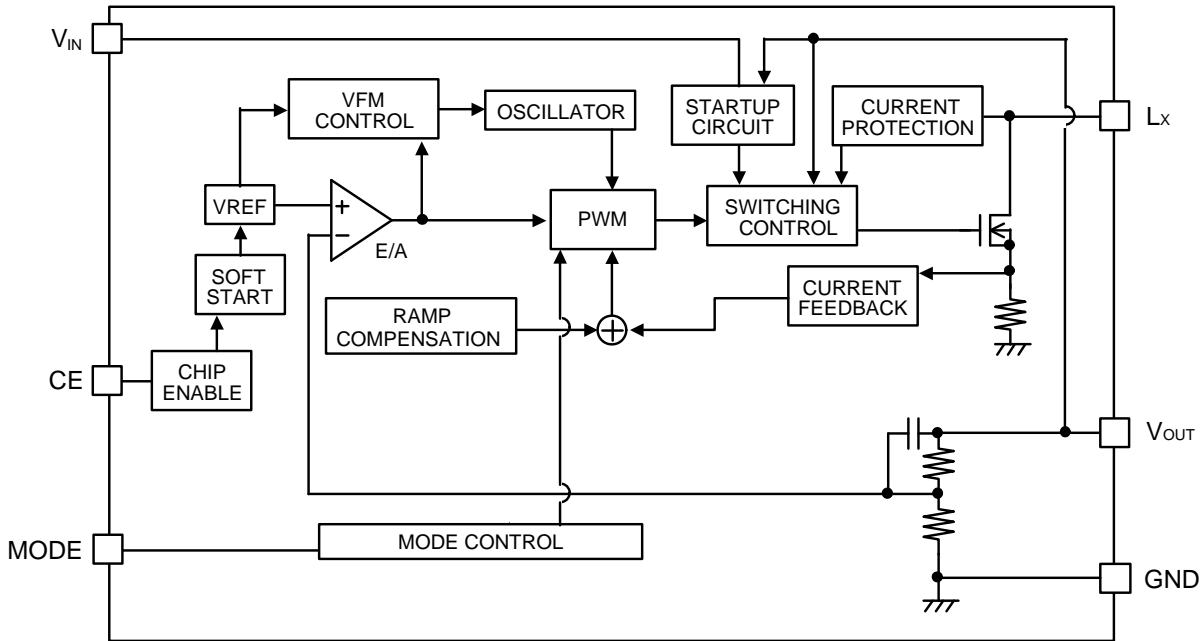

### Adjustable output type: RP401K001C/D

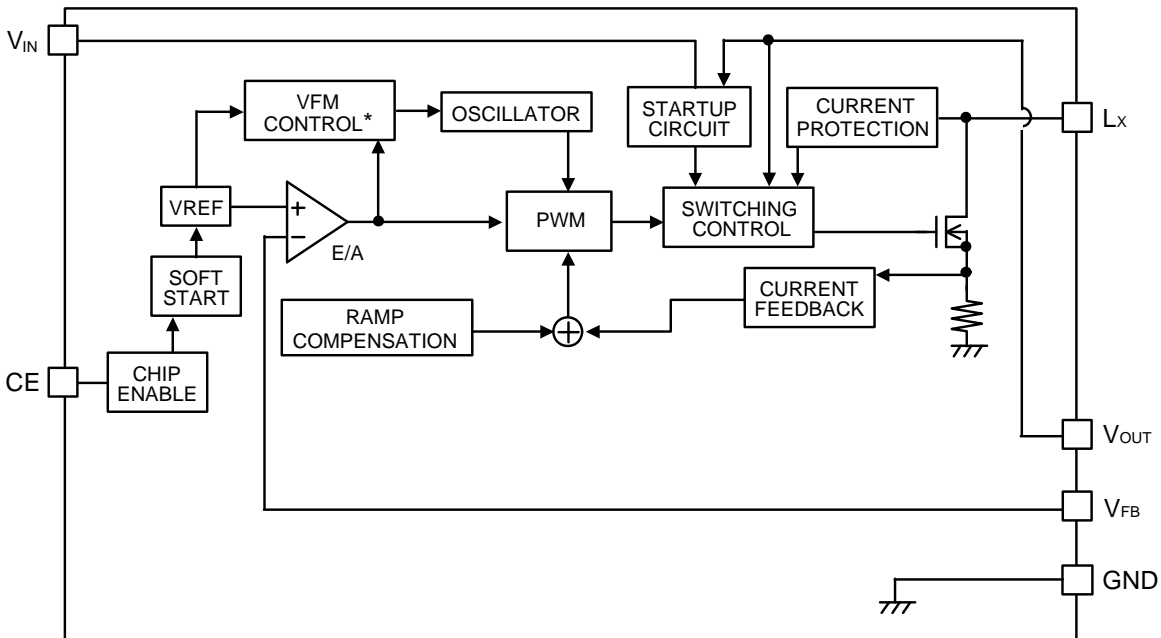

\*) Applied to PWM/VFM automatic shift, RP401K001C only.

**Fixed output type: RP401Nxx1C/D**

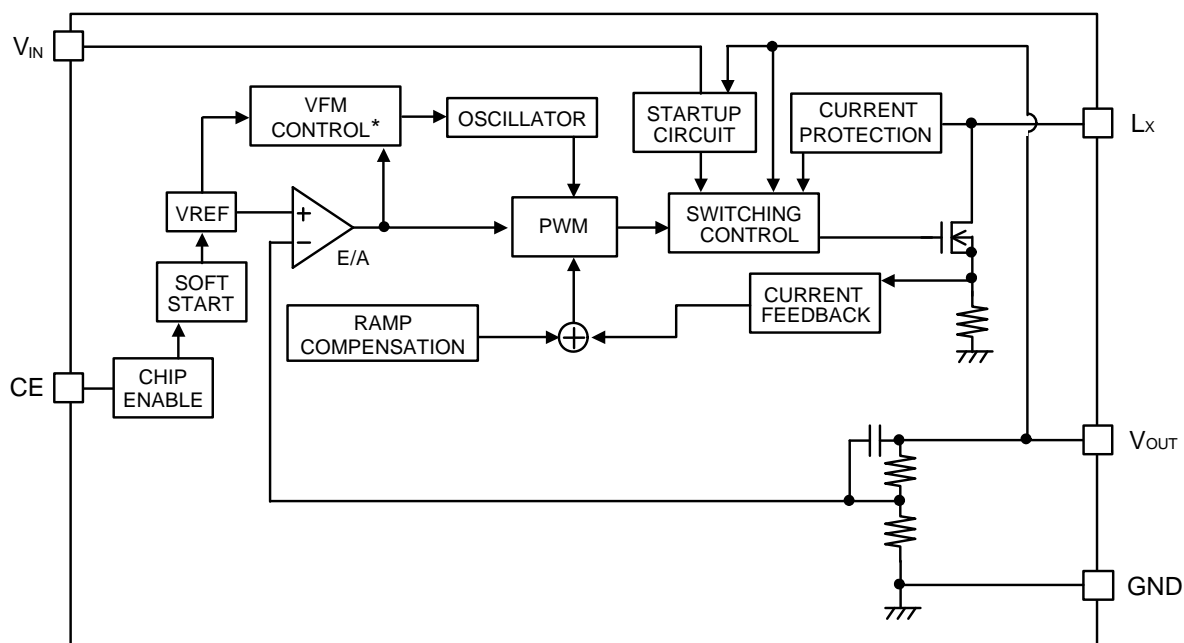

\*) Applied to PWM/VFM automatic shift, RP401Nxx1C only.

**SELECTION GUIDE**

In the RP400 Series, output Voltage, Type of Output Voltage, and package for the ICs can be selected at the user's request.

Product Name	Package	Quantity per Reel	Pb Free	Halogen Free
RP401Kxx1\$-TR	DFN (PLP)1820-6	5,000 pcs	Yes	Yes
RP401Nxx1\$-TR-FE	SOT-23-5	3,000 pcs	Yes	Yes

xx: Designation of output voltage  
 00: Adjustable Version (1.8V ~ 5.5V) \* recommendation range of output voltage / DFN(PLP)1820-6 only  
 xx: Fixed version: designation is possible in the range from 1.8V to 5.5V with a step of 0.1V

\$: Designation of option.  
 A: with Mode pin, latch type over-current protection circuit  
 B: with Mode pin, without latch type over-current protection circuit  
 C: without Mode pin (PWM/VFM automatic shift)  
 D: without Mode pin (PWM-fix)

# RP401x

Product code table

Version	MODE pin	Output Voltage	Latch type over-current protection	package
A	Yes	Fixed	Yes	DFN(PLP)1820-6
B	Yes	Fixed	No	DFN(PLP)1820-6
C	No (PWM/VFM automatic shift)	Fixed	No	SOT-23-5
		Adjustable	No	DFN(PLP)1820-6
D	No (PWM fix)	Fixed	No	SOT-23-5
		Adjustable	No	DFN(PLP)1820-6

## PIN CONFIGURATION

DFN(PLP)1820-6

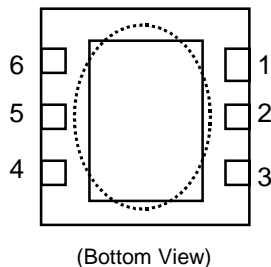

SOT-23-5

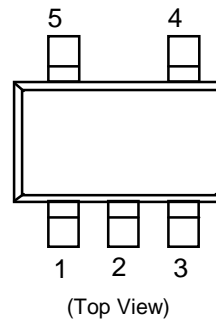

## PIN DESCRIPTION

RP401Kxx1A/B: DFN(PLP)1820-6

Pin No	Symbol	Pin Description
1	$V_{IN}$	Power Supply Pin
2	CE	Chip Enable Pin (Active with "H")
3	GND	Ground Pin
4	Lx	Internal NMOS Switch Drain Pin
5	MODE	Mode pin for switch over PWM-fix or PWM/VFM alternative
6	$V_{OUT}$	Output Pin

\* Tab is GND level. (They are connected to the reverse side of this IC.) Connected to the GND is the recommendation, leaving it open is also possible.

RP401K001C/D: DFN(PLP)1820-6

Pin No	Symbol	Pin Description
1	$V_{IN}$	Power Supply Pin
2	CE	Chip Enable Pin (Active with "H")
3	GND	Ground Pin
4	Lx	Internal NMOS Switch Drain Pin
5	$V_{FB}$	Feedback input voltage for setting output voltage
6	$V_{OUT}$	Output Pin

\* Tab is GND level. (They are connected to the reverse side of this IC.) Connected to the GND is the recommendation, leaving it open is also possible.

**RP401Nxx1C/D: SOT-23-5**

Pin No	Symbol	Pin Description
1	CE	Chip Enable Pin (Active "H")
2	GND	Ground Pin
3	V <sub>IN</sub>	Power Supply Pin
4	V <sub>OUT</sub>	Output Pin
5	Lx	Internal NMOS Switch Drain Pin

**ABSOLUTE MAXIMAM RATINGS**

(GND=0V)

Symbol	Items	Ratings		Unit
V <sub>IN</sub>	V <sub>IN</sub> Supply Voltage	-0.3 to 6.0		V
V <sub>OUT</sub>	V <sub>OUT</sub> Pin Voltage	-0.3 to 6.0		V
V <sub>LX</sub>	Lx Pin Input Voltage	-0.3 to 6.0		V
V <sub>CE</sub>	CE Pin Voltage	-0.3 to 6.0		V
V <sub>FB</sub>	V <sub>FB</sub> Pin Voltage	RP401K001C/D	-0.3 to 6.0	V
V <sub>MODE</sub>	MODE Pin Voltage	RP401K001A/B	-0.3 to 6.0	V
P <sub>D</sub>	Power Dissipation *	SOT-23-5	420	mW
		DFN(PLP)1820-6	880	
T <sub>a</sub>	Ambient Temp Range	-40 to +85		°C
T <sub>stg</sub>	Storage Temp Range	-55 to +125		°C

\*) As for Power Dissipation, refer to PACKAGE INFORMATION.

**ABSOLUTE MAXIMUM RATINGS**

Electronic and mechanical stress momentarily exceeded absolute maximum ratings may cause the permanent damages and may degrade the lifetime and safety for both device and system using the device in the field. The functional operation at or over these absolute maximum ratings is not assured.

**RECOMMENDED OPERATING CONDITIONS (ELECTRICAL CHARACTERISTICS)**

All of electronic equipment should be designed that the mounted semiconductor devices operate within the recommended operating conditions. The semiconductor devices cannot operate normally over the recommended operating conditions, even if when they are used over such conditions by momentary electronic noise or surge. And the semiconductor devices may receive serious damage when they continue to operate over the recommended operating conditions.

## ELECTRICAL CHARACTERISTICS

### Adjustable types (RP401K001C/D)

(Ta=25°C)

Symbol	Item	Conditions	MIN.	TYP.	MAX.	Unit	
V <sub>IN</sub>	Input Voltage				5.5	V	
V <sub>start</sub>	Start-up Voltage	Load current =1mA		0.6	0.8	V	
V <sub>hold</sub>	Hold-on Voltage	Load current=1mA	0.6			V	
I <sub>DD1</sub>	Quiescent Current 1	V <sub>IN</sub> =2V, V <sub>OUT</sub> =2.5V, V <sub>FB</sub> =0V		380	500	μA	
I <sub>DD2</sub>	Quiescent Current 2 (No switching)	001C	V <sub>IN</sub> =V <sub>OUT</sub> =5.5V, V <sub>FB</sub> =1.0V		130	190	μA
		001D			230	320	μA
I <sub>standby</sub>	Standby Current	V <sub>IN</sub> =V <sub>OUT</sub> =5.5V, V <sub>CE</sub> =0V		0.15	3.00	μA	
V <sub>FB</sub>	Feedback Voltage	V <sub>IN</sub> =V <sub>OUT</sub> =3.3V	0.588	0.600	0.612	V	
ΔV <sub>OUT</sub> / ΔTa	Output-Voltage Temperature Coefficient	-40°C ≤ Ta ≤ 85°C		±80		ppm / °C	
F <sub>osc</sub>	Switching Frequency	V <sub>IN</sub> =V <sub>OUT</sub> =3.3V, V <sub>FB</sub> =0V	1020	1200	1380	kHz	
Δf <sub>osc</sub> / ΔTa	Switching Frequency Temperature Coefficient	-40°C ≤ Ta ≤ 85°C		±0.2		kHz / °C	
R <sub>ONN</sub>	NMOS On-Resistance (*1)	V <sub>OUT</sub> =3.3V		0.4		Ω	
I <sub>CEH</sub>	CE "H" Input Current	V <sub>IN</sub> =V <sub>OUT</sub> =V <sub>CE</sub> =5.5V			0.2	μA	
I <sub>CEL</sub>	CE "L" Input Current	V <sub>IN</sub> =V <sub>OUT</sub> =5.5V, V <sub>CE</sub> =0V	-0.2			μA	
I <sub>FBH</sub>	FB "H" Input Current	V <sub>IN</sub> =V <sub>OUT</sub> =V <sub>FB</sub> =5.5V			0.2	μA	
I <sub>FBL</sub>	FB "L" Input Current	V <sub>IN</sub> =V <sub>OUT</sub> =5.5V, V <sub>FB</sub> =0V	-0.2			μA	
I <sub>LX</sub>	Lx Leakage Current	V <sub>IN</sub> =V <sub>OUT</sub> =V <sub>LX</sub> =5.5V, V <sub>CE</sub> =0V			2	μA	
I <sub>Lxpeak</sub>	Lx Current limit (*2)	V <sub>IN</sub> =V <sub>SET</sub> ×0.5V	0.86	1.00		A	
V <sub>CEH</sub>	CE Input Voltage "H"		0.7			V	
V <sub>CEL</sub>	CE Input Voltage "L"				0.4	V	
Maxduty	Maximum Duty Cycle	V <sub>IN</sub> =V <sub>OUT</sub> =3.3V, V <sub>FB</sub> =0V	80	88	95	%	
t <sub>start</sub>	Soft start Time	V <sub>IN</sub> =1.65V, V <sub>OUT</sub> =3.3V, the time interval from V <sub>CE</sub> changing from 0V to 1.5V edge to V <sub>OUT</sub> being 2.97V		0.7	3.0	ms	

\*1) Guaranteed by design. NMOS On-Resistance depends on the V<sub>OUT</sub> voltage.

\*2) Lx limit current changes according to the switching duty ratio.

Fixed output voltage types (RP401Kxx1A/B, RP401Nxx1C/D)

(Ta=25°C)

Symbol	Item	Conditions	MIN.	TYP.	MAX.	Unit
V <sub>IN</sub>	Input Voltage				5.5	V
V <sub>start</sub>	Start-up Voltage	Load current =1mA		0.6	0.8	V
V <sub>hold</sub>	Hold-on Voltage	Load current=1mA	0.6			V
I <sub>DD1</sub>	Quiescent Current 1	V <sub>IN</sub> =0.5xV <sub>SET</sub> , V <sub>OUT</sub> =0.95xV <sub>SET</sub>		V <sub>OUT</sub> x90 +130	V <sub>OUT</sub> x100 +250	μA
I <sub>DD2</sub>	Quiescent Current 2 (No switching)	xx1A/B/C	V <sub>IN</sub> =V <sub>OUT</sub> =5.5V	130	190	μA
		xx1D		230	320	μA
I <sub>standby</sub>	Standby Current	V <sub>IN</sub> =V <sub>OUT</sub> =5.5V, V <sub>CE</sub> =0V		0.15	3.00	μA
V <sub>OUT</sub>	Output Voltage	V <sub>IN</sub> =V <sub>CE</sub> =1.5V	x0.98		x1.02	V
ΔV <sub>OUT</sub> /ΔTa	Output-Voltage Temperature Coefficient	-40°C≤Ta≤85°C		±80		ppm /°C
F <sub>osc</sub>	Switching Frequency	V <sub>IN</sub> =V <sub>OUT</sub> =3.3V, V <sub>FB</sub> =0V	1020	1200	1380	kHz
Δf <sub>osc</sub> /ΔTa	Switching Frequency Temperature Coefficient	-40°C≤Ta≤85°C		±0.2		kHz /°C
R <sub>ONN</sub>	NMOS On-Resistance (*1)	V <sub>OUT</sub> =3.3V		0.4		Ω
I <sub>CEH</sub>	CE "H" Input Current	V <sub>IN</sub> =V <sub>OUT</sub> =V <sub>CE</sub> =5.5V			0.2	μA
I <sub>CEL</sub>	CE "L" Input Current	V <sub>IN</sub> =V <sub>OUT</sub> =5.5V, V <sub>CE</sub> =0V	-0.2			μA
I <sub>MODEH</sub>	MODE "H" Input Current	V <sub>IN</sub> =V <sub>OUT</sub> =V <sub>MODE</sub> =5.5V			0.2	μA
I <sub>MODEL</sub>	MODE "L" Input Current	V <sub>IN</sub> =V <sub>OUT</sub> =5.5V, V <sub>MODE</sub> =0V	-0.2			μA
I <sub>LX</sub>	Lx Leakage Current	V <sub>IN</sub> =V <sub>OUT</sub> =V <sub>LX</sub> =5.5V, V <sub>CE</sub> =0V			2	μA
I <sub>Lxpeak</sub>	Lx Current limit (*2)	V <sub>IN</sub> =V <sub>SET</sub> x0.5V	0.86	1.00		A
V <sub>CEH</sub>	CE Input Voltage "H"		0.7			V
V <sub>CEL</sub>	CE Input Voltage "L"				0.4	V
Maxduty	Maximum Duty Cycle	V <sub>IN</sub> =V <sub>OUT</sub> =0.95 x V <sub>SET</sub>	80	88	95	%
t <sub>start</sub>	Soft start Time	V <sub>IN</sub> =V <sub>SET</sub> x 0.5, the time interval from V <sub>CE</sub> changing from 0V to 1.5V edge to V <sub>OUT</sub> being V <sub>SET</sub> x 0.9		0.7	3.0	ms
t <sub>prot</sub>	Protection Delay Time	V <sub>IN</sub> =V <sub>CE</sub> =3.3V		3.3	5.0	ms

\*1) Guaranteed by design. NMOS On-Resistance depends on the V<sub>OUT</sub> voltage.

\*2) Lx limit current changes according to the switching duty ratio.

\*3) Applied to A/B version

\*4) Applied to A version.

### APPLICATION NOTES

#### Fixed Output Voltage Type (RP401Kxx1A/B)

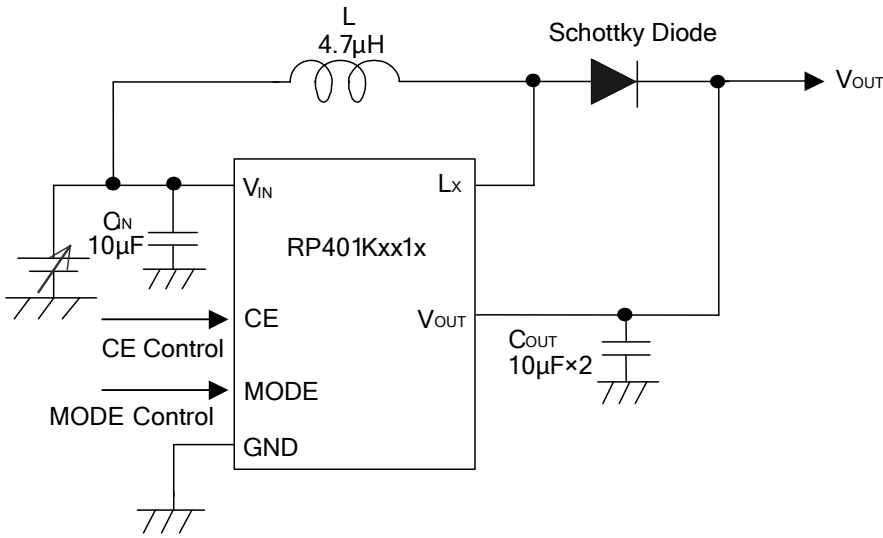

#### Adjustable output type (RP401K001C/D)

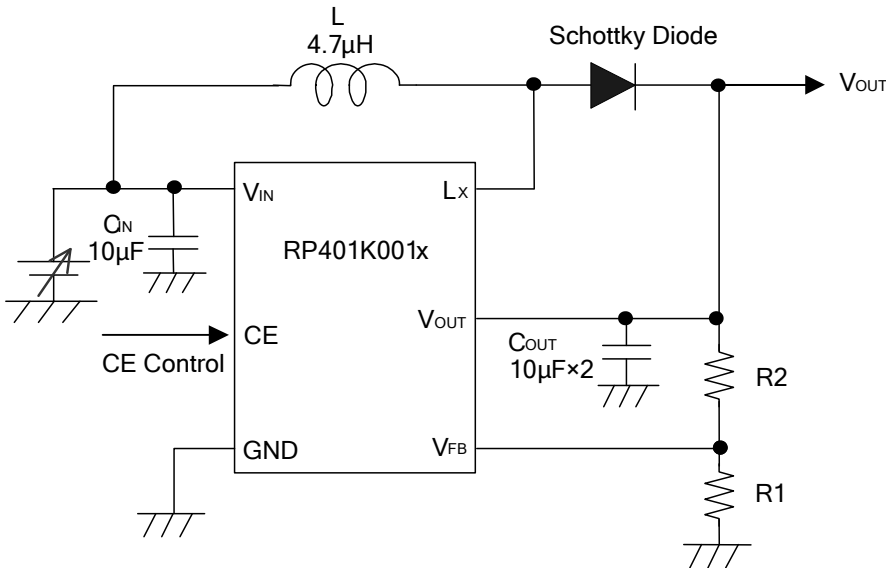



**Fixed output type (RP401Nxx1C/D)**

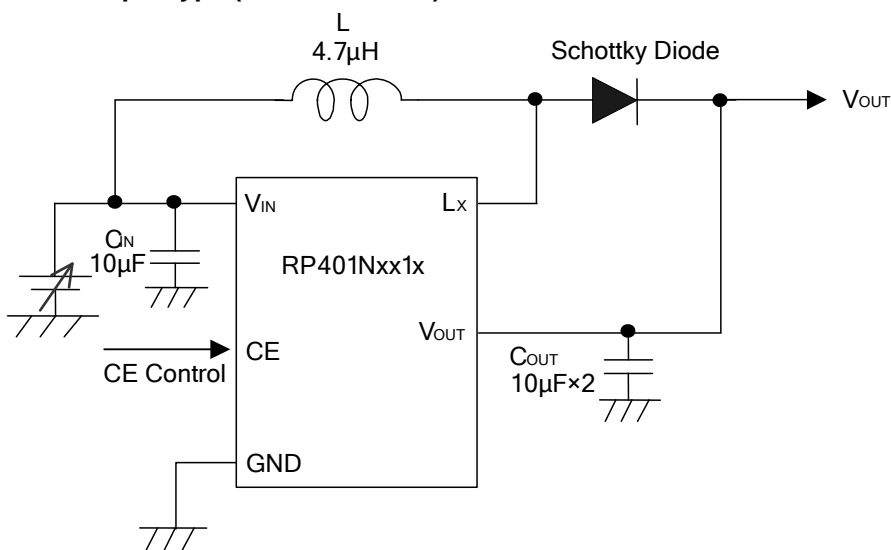

**External components**

Capacitor  $C_{IN}$ : C1608JB0J106M (TDK),  $C_{OUT}$ :

$V_{OUT}[V]$	$I_{Lmax} < 700mA$	$I_{Lmax} \geq 700mA$
$1.8 \leq V_{OUT} < 3.3$	C1608JB0J106M×2 (10µF×2, TDK)	
$3.3 \leq V_{OUT} \leq 5.5$	C1608JB0J106M (10µF, TDK)	C1608JB0J106M×2 (10µF×2, TDK)

Diode:  $I_{Lmax} < 700mA$ , CRS10I30A (TOSHIBA).  $I_{Lmax} \geq 700mA$ , CMS06 (TOSHIBA)

Inductor: SLF6028T-4R7M1R6-PF (TDK), depending on the conditions, smaller L can be used with.  
(ex. VLS2012: TDK)

● **Setting of Output Voltage for RP401K001C/D**

Output voltage can be set with divider resistors for voltage setting, R1 and R2 as shown in the typical application. Refer to the next formula.

$$\text{Output Voltage} = V_{FB} \times (R1 + R2) / R1 \quad (V_{FB} = 0.6V)$$

Recommended value of resistors: Choose R1 and R2 so as to become (R1 + R2) being lower than 100kΩ.

Make sufficient power supply and ground. The large switching current may flow through the power line and GND line. If their impedance is high, the internal voltage of the IC may shift by the switching current and unstable operation may result. At turning off the built-in Lx switch, an over-shoot spike on the output may be generated by the inductor, therefore voltage rating of the output capacitor and the diode is 1.5 or more times as much as setting output voltage.

Use a diode of a low Vf Schottky type with high switching speed, low reverse current, and the current rating.

The RP401x uses the  $V_{OUT}$  voltage as the main power supply after start-up. Therefore the capacitor between Vout and GND has a role of the bypass capacitor for this IC. Use capacitors with a capacity of 10µF or more for

---

## RP401x

---

$V_{OUT}$  pin. Consider the bias shift, choose the enough capacity of the capacitor. A ceramic capacitor ( $10\mu\text{F}$ ) between  $V_{IN}$  and ground should be set.

The inductor value recommendation is  $4.7\mu\text{H}$ . Choose an inductor that has small D.C. resistance and large enough permissible current and hard to reach magnetic saturation.

If the spike noise on Lx pin is large, put a snub circuit (CR serial connection etc.) in parallel with the diode and reduce the spike noise. The time constants of CR depends on the PCB and have an impact on the efficiency, therefore fully evaluation is necessary. (Basic value is  $10\text{ohm}$  and  $300\text{pF}$ )

The MODE pin is controlled with a logic voltage. To make it "H",  $1.0\text{V}$  or more must be forced to the MODE pin. If power supply is less than  $1.0\text{V}$ , MODE pin must be pulled up to  $V_{OUT}$ .

The RP401xxxxA can reset the latch protection with CE signal. If  $C_{IN}$  is too large, and  $V_{IN}$  does not reach  $0.8\text{V}$ , even if the IC starts up with CE signal, the latch operation may not be reset correctly. The sequence of  $V_{IN}$  and CE must be cared. In the case of CE pin pulled-up to  $V_{IN}$  pin or  $V_{OUT}$  pin, the operation of latch protection reset may not work correctly.

\*The performance of power circuit using those lcs extremely depends upon the peripheral circuits. Pay attention in the selection of the peripheral circuits. In particular, design the peripheral circuits in a way that the values such as voltage, current, and power of each component, PCB patterns and the IC do not exceed their respected rated values. (such as the voltage, current , and power)

## OUTPUT CURRENT OF STEP-UP CIRCUIT AND EXTERNAL COMPONENTS

<Basic Circuit>

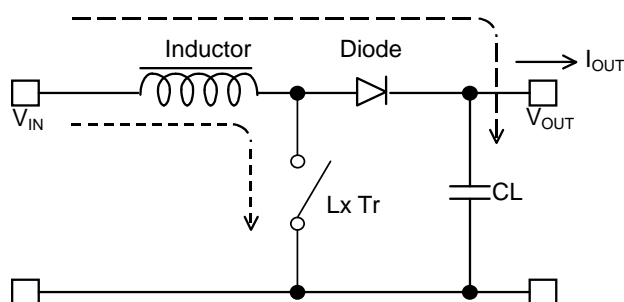

<Current through L>

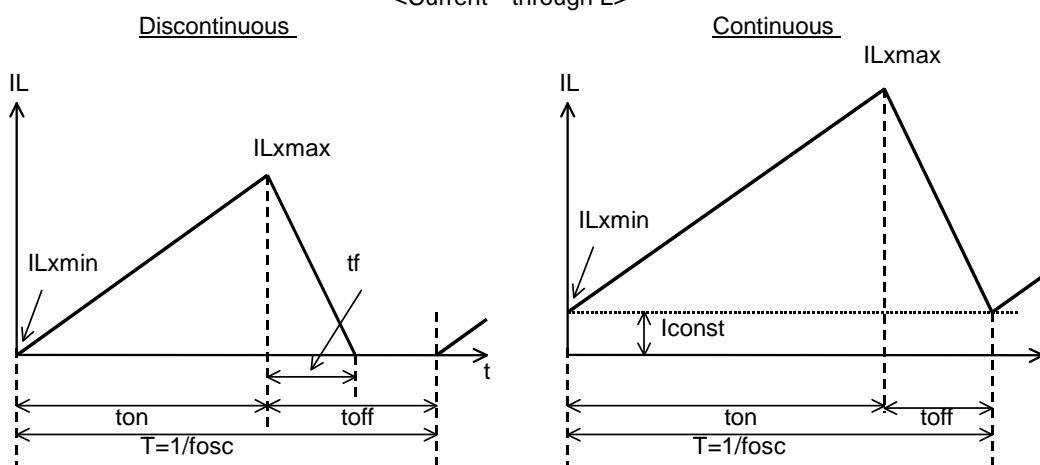

There are two modes, or discontinuous mode and continuous mode for the PWM step-up switching regulator depending on the continuous characteristic of inductor current. During on time of the transistor, when the voltage added on to the inductor is described as  $V_{IN}$ , the current is  $V_{IN} \times t / L$ .

Therefore, the electric power,  $P_{ON}$ , which is supplied with input side, can be described as in the next formula.

$$P_{ON} = \int_0^{ton} V_{IN}^2 \times t/L dt \dots\dots\dots \text{Formula 1}$$

With the step-up circuit, electric power is supplied from power source also during off time. In this case, input current is described as  $(V_{OUT} - V_{IN}) \times t / L$ , therefore electric power,  $P_{OFF}$  is described as in the next formula.

$$P_{OFF} = \int_0^{tf} V_{IN} \times (V_{OUT} - V_{IN})t/L dt \dots\dots\dots \text{Formula 2}$$

In this formula,  $tf$  means the time of which the energy saved in the inductance is being emitted. Thus average electric power,  $P_{AV}$  is described as in the next formula.

$$P_{AV} = 1/(ton + toff) \times \left\{ \int_0^{ton} V_{IN}^2 \times t/L dt + \int_0^{tf} V_{IN} \times (V_{OUT} - V_{IN})t/L dt \right\} \dots\dots\dots \text{Formula 3}$$

In PWM control, when  $t_f = t_{off}$  is true, the inductor current becomes continuous, then the operation of switching regulator becomes continuous mode. In the continuous mode, the deviation of the current is equal between on time and off time.

$$V_{IN} \times t_{on} / L = (V_{OUT} - V_{IN}) \times t_{off} / L \dots\dots\dots \text{Formula 4}$$

Further, the electric power, PAV is equal to the output electric power,  $V_{OUT} \times I_{OUT}$ , thus,

$$I_{OUT} = f_{osc} \times V_{IN}^2 \times t_{on}^2 / \{2 \times L (V_{OUT} - V_{IN})\} = V_{IN}^2 \times t_{on} / (2 \times L \times V_{OUT}) \dots\dots\dots \text{Formula 5}$$

When  $I_{OUT}$  becomes more than  $V_{IN} \times t_{on} \times t_{off} / (2 \times L \times (t_{on} + t_{off}))$ , the current flows through the inductor and the mode becomes continuous. The continuous current through the inductor is described as  $I_{const}$ , then,

$$I_{OUT} = f_{osc} \times V_{IN}^2 \times t_{on}^2 / (2 \times L \times (V_{OUT} - V_{IN})) + V_{IN} \times I_{const} / V_{OUT} \dots\dots\dots \text{Formula 6}$$

In this moment, the peak current,  $I_{lxmax}$  flowing through the inductor and the driver Tr. Is described as follows:

$$I_{lxmax} = I_{const} + V_{IN} \times t_{on} / L \dots\dots\dots \text{Formula 7}$$

With the formula 4, 6 and  $I_{lxmax}$  is

$$I_{lxmax} = V_{OUT} / V_{IN} \times I_{OUT} + V_{IN} \times t_{on} / (2 \times L) \dots\dots\dots \text{Formula 8}$$

However,  $t_{on} = (1 - V_{IN} / V_{OUT}) / f_{osc}$

Therefore, peak current is more than  $I_{OUT}$ . Considering the value of  $I_{lxmax}$ , the condition of input and output, and external components should be selected.

In the formula 7, peak current  $I_{lxmax}$  at discontinuous mode can be calculated. Put  $I_{const} = 0$  in the formula.

The explanation above is based on the ideal calculation, and the loss caused by Lx switch and external components is not included.

Select the inductor and the diode with considering the peak current of the (Formula 8).

## TIMING CHART

### Soft start operation and Latch protection operation

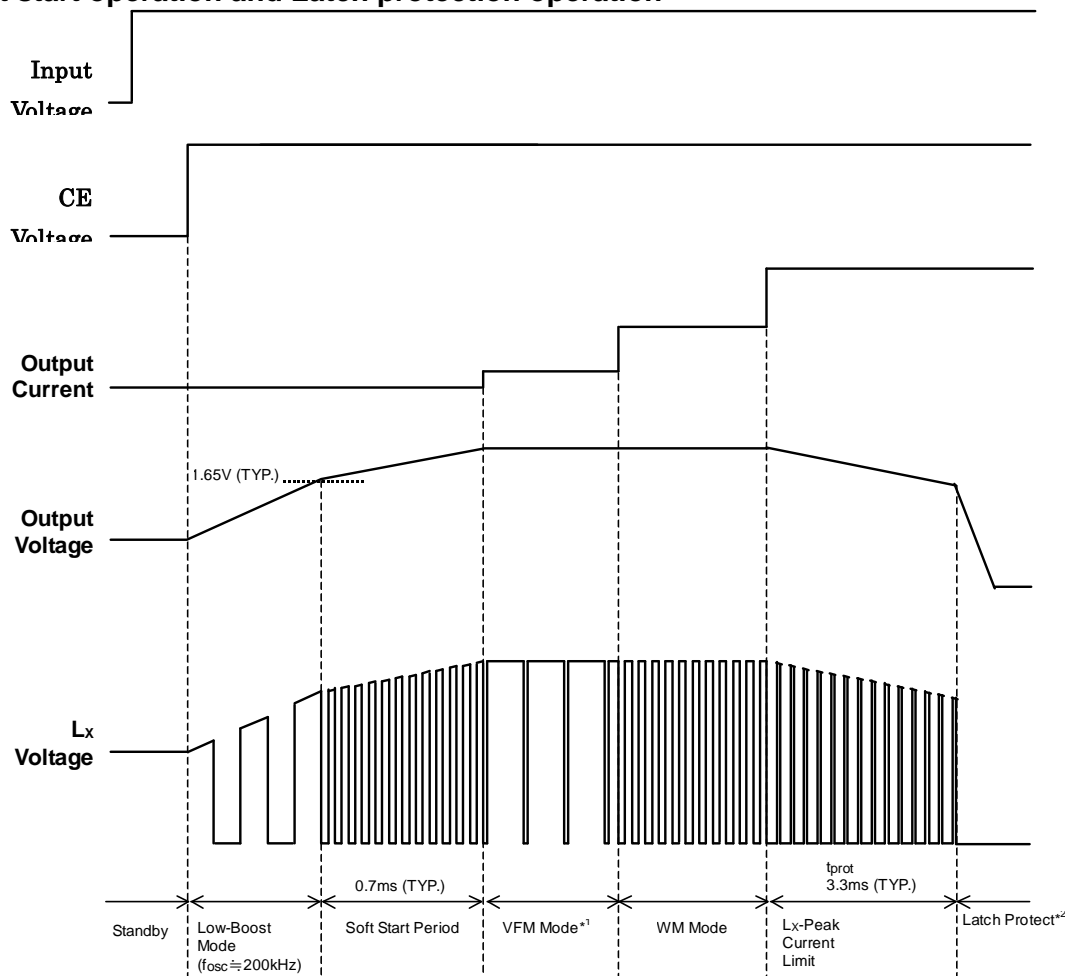

\*1) Applied to A/B/C version. (MODE="L" for version A/B)

\*2) Applied to A version only.

<Start-up> When the CE pin becomes from "L" to "H", then the DC/DC converter starts up. In the RP401 series, low input voltage (Typ. 0.6V) operation is possible due to the low-boost mode. Until the output voltage reaches 1.65V (Typ.) the mode is low-boost mode. When the output voltage becomes 1.65V or more, to suppress the inrush current, soft start operation starts and boosts the output voltage to set value.

\*) At the low-boost mode, the oscillator frequency is reduced to 200kHz (Typ.), therefore, compared with the normal operation frequency 1.2MHz, the boost capability is worse. Therefore, step-up ratio and load current must be cared.

\*) Soft-start time depends on the set output voltage, input voltage, temperature, and the load current. Refer to the next graphs.

Soft Start Period vs. Input Voltage RP401xxx1x  
 $I_{OUT}=1mA$

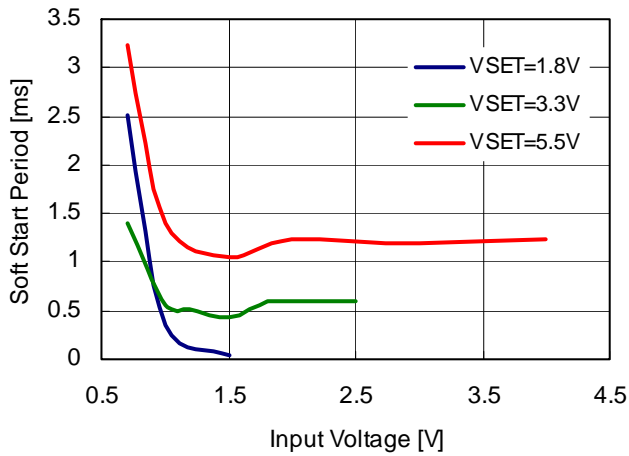

Soft Start Period vs. Temperature RP401xxx1x  
 $V_{IN}=V_{SET}\times 0.5, RL=1k\Omega$

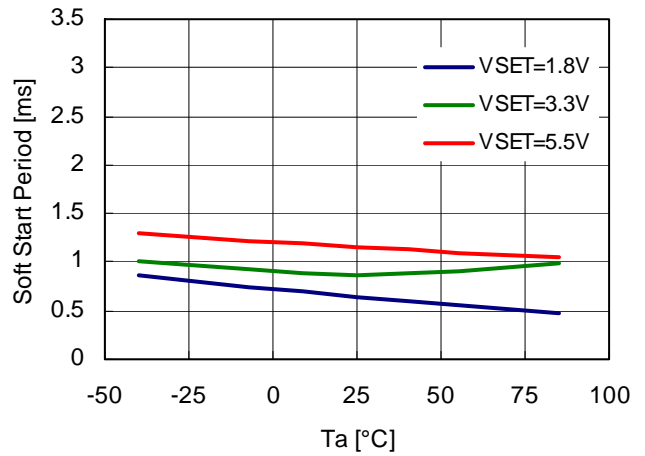

**<Over-current protection operation>**

If the Lx peak current reaches 1.0A (Typ.), then Lx peak current limit circuit operates and control the duty ratio of Lx switch.

<Latch Protection Operation> applied to A version only

If over current state continues for a protection delay time ( $t_{PROT}$ ), then latch protection function starts and latch the internal driver switch being off and the operation of DC/DC converter will stop.

To release the latch protection circuit, toggled input for CE pin is necessary.

Lx current limit( $I_{LXPEAK}$ ) and the protection delay time ( $t_{prot}$ ) are influenced by the self-heating, heat radiation environment at mounting on board. If short circuit may happen, input voltage ( $V_{IN}$ ) drops largely or becomes unstable, the protection operation and the delay time will be influenced.

# TYPICAL CHARACTERISTICS

1) Output voltage vs. output current ( $T_a=25^\circ\text{C}$ )

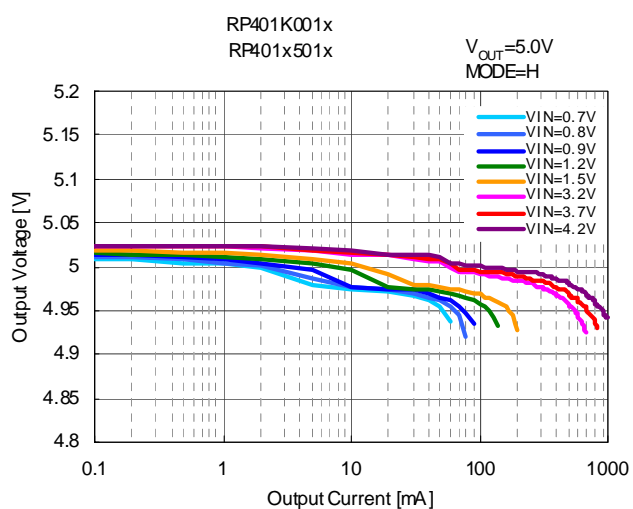
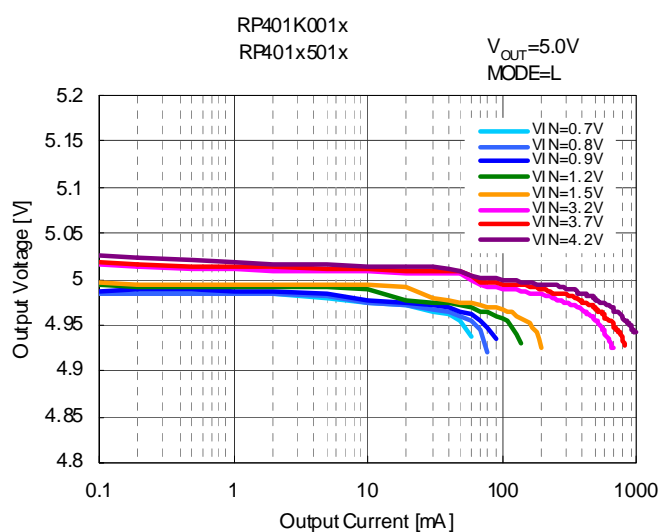
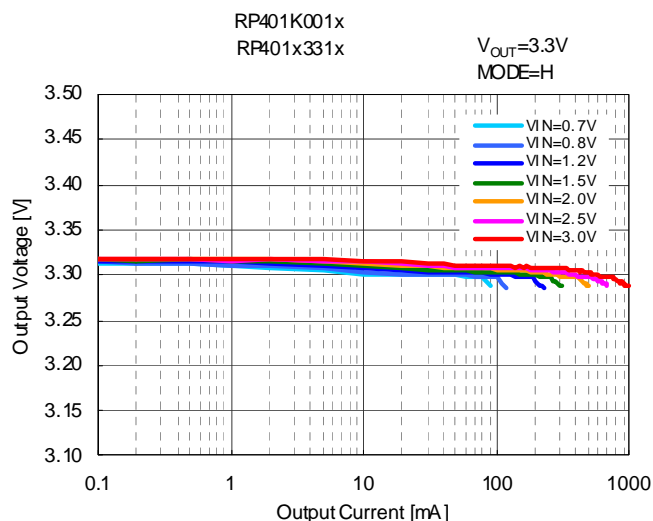
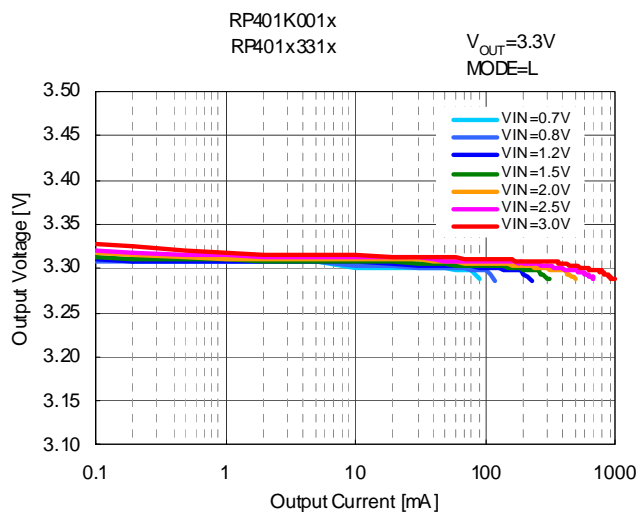
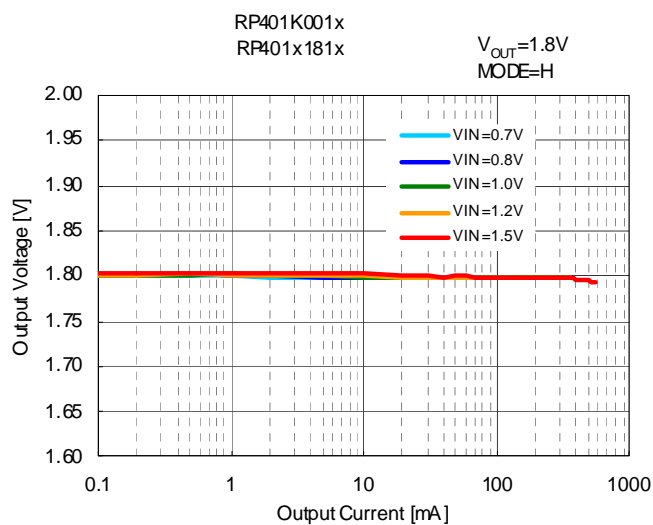
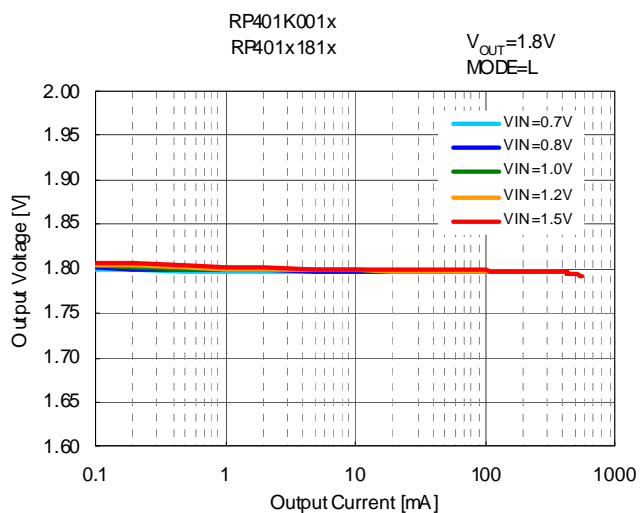

# RP401x

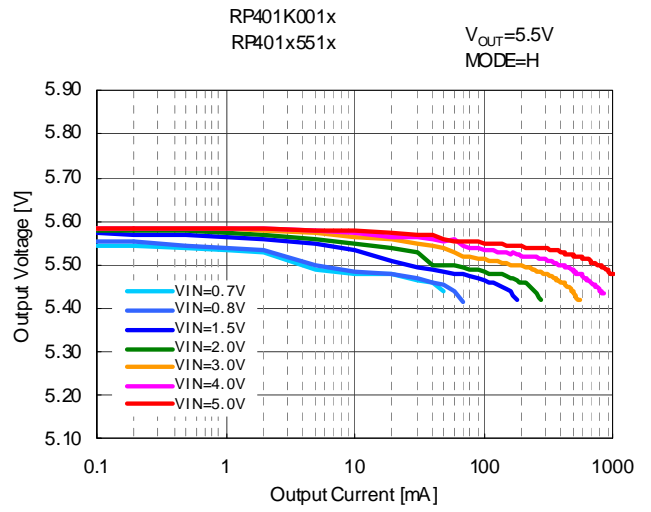
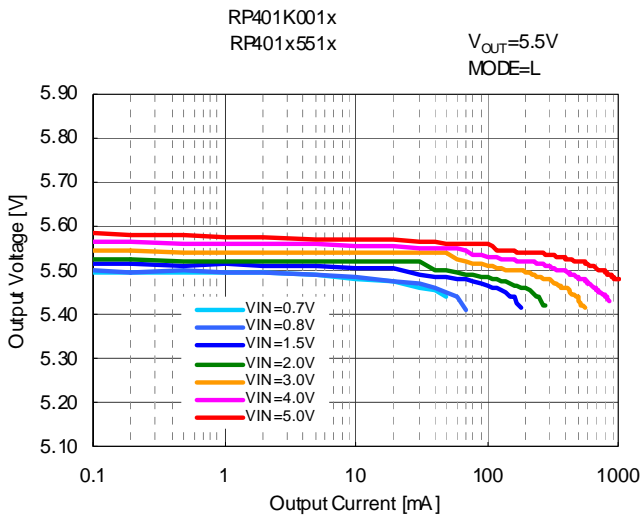

## 2) Efficiency vs. Output current (Ta=25°C)

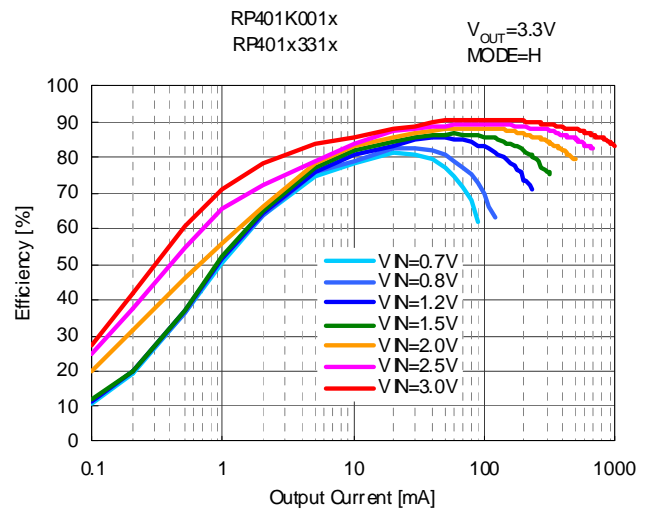
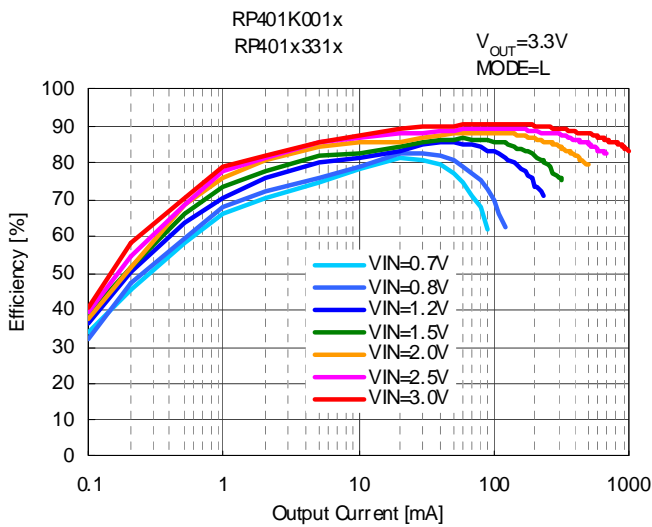
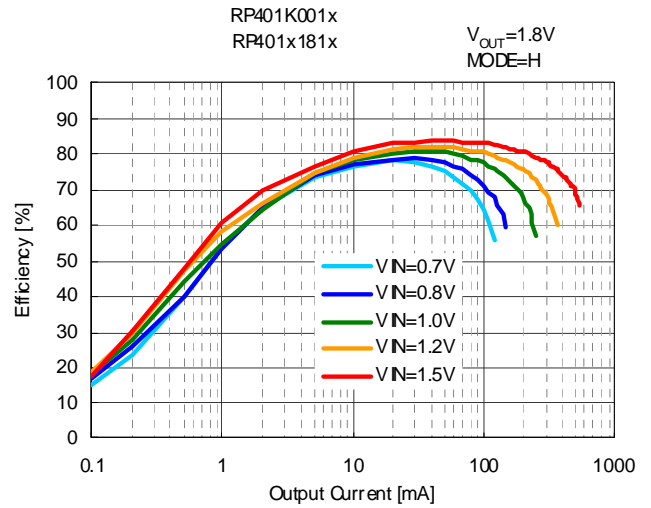
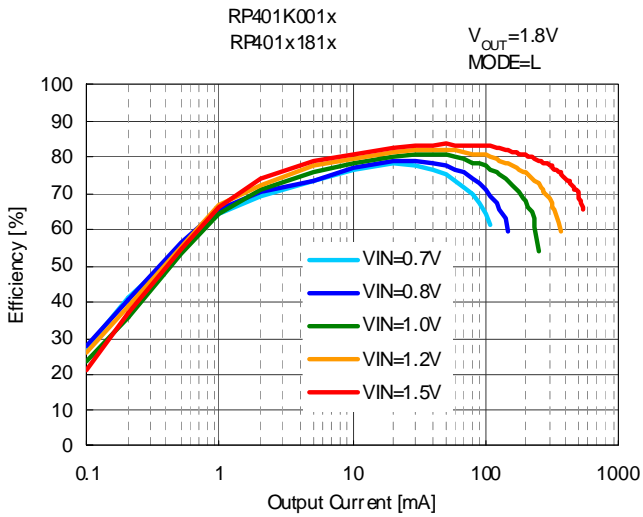



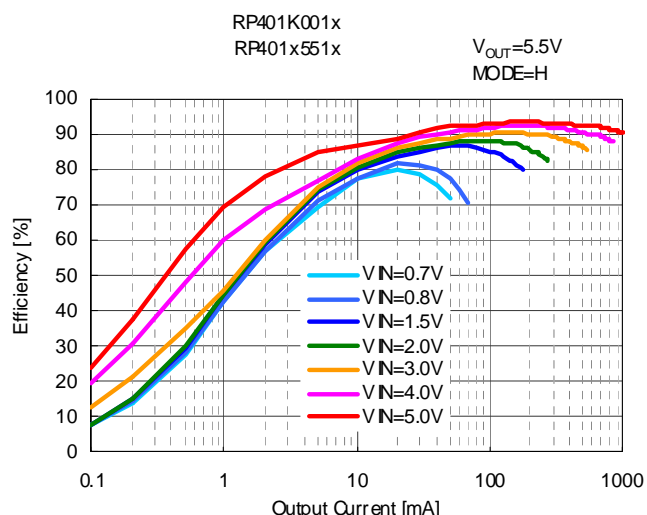
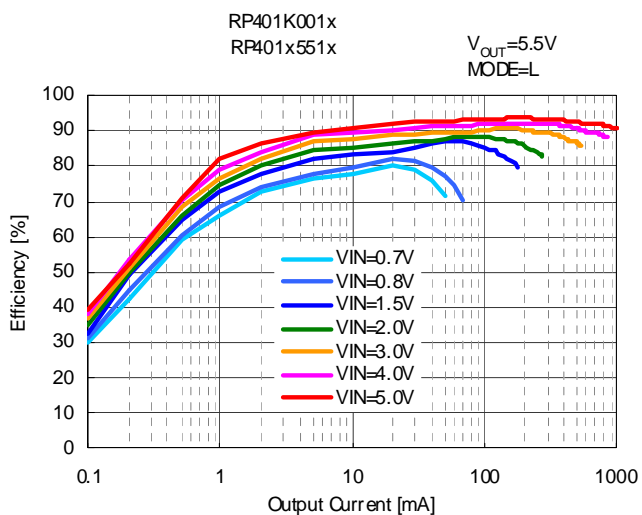
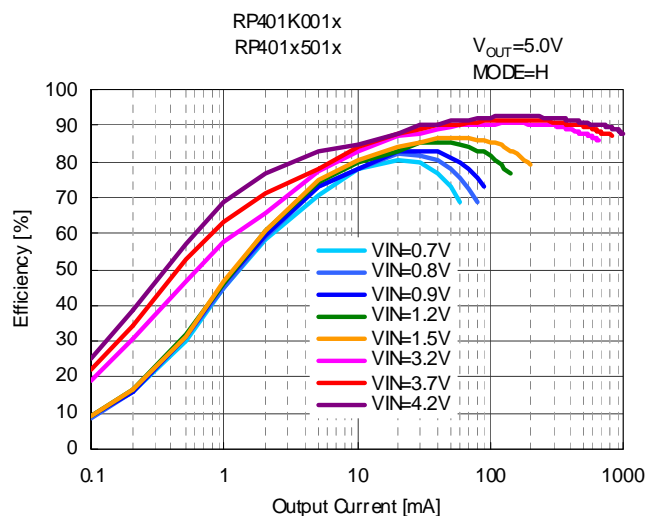
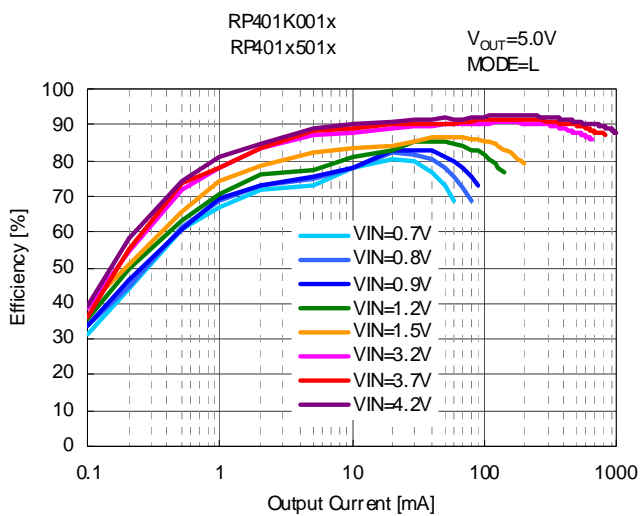

3) Standby Current vs. Temperature

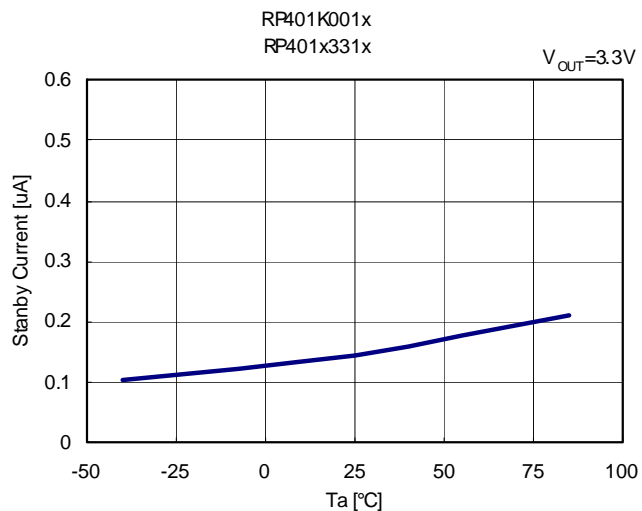

4) Supply Current1 vs. Temperature

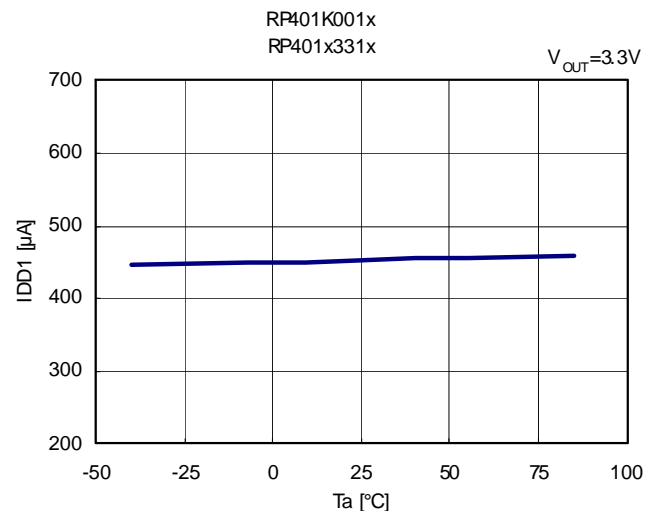

# RP401x

## 5) Supply Current 2 vs. Temperature

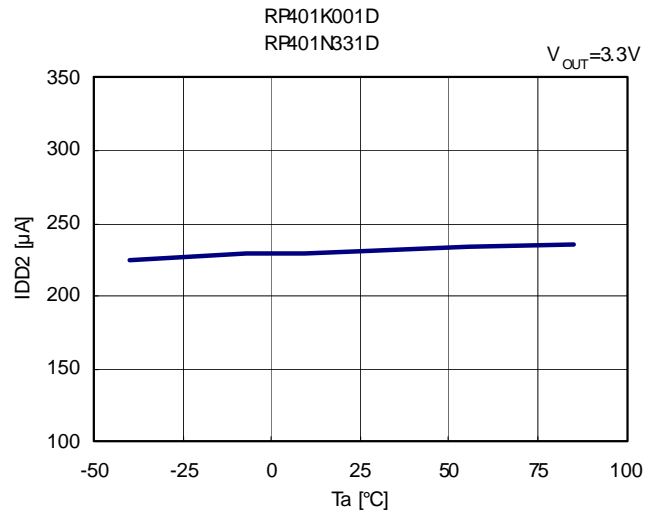
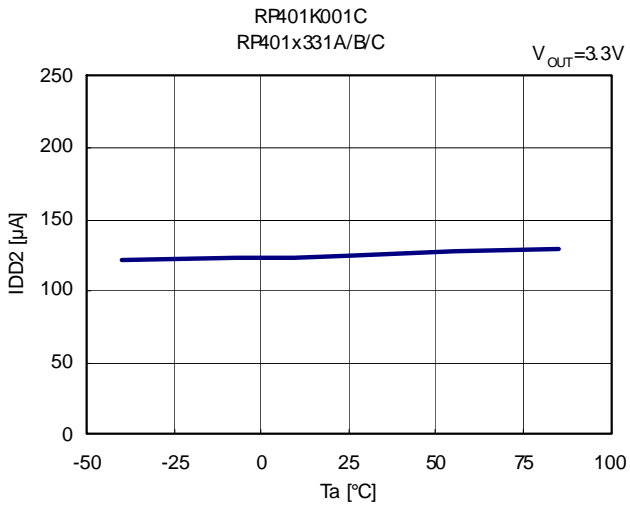

## 6) Start-up voltage 1 vs. Temperature

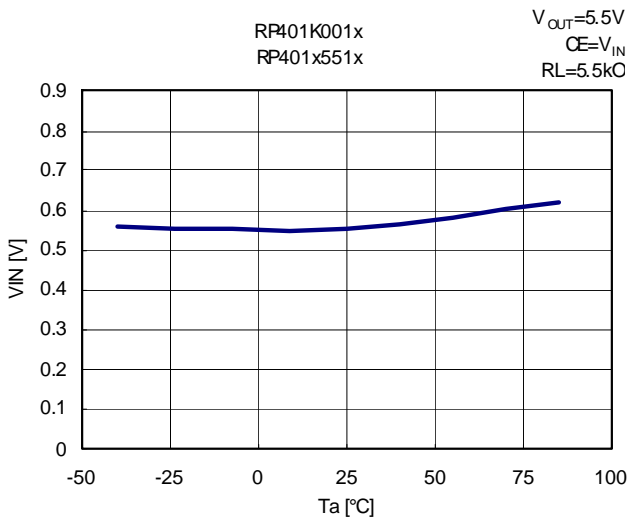

## 7) Start-up Voltage 2 vs. Temperature

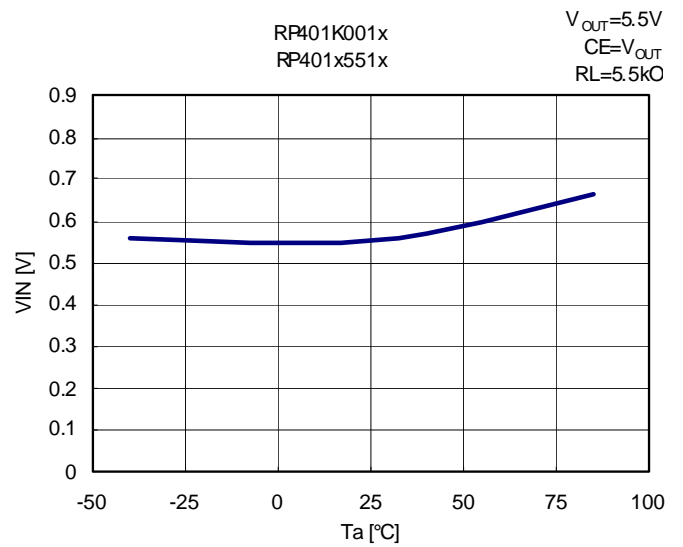

## 8) Soft start time vs. Temperature

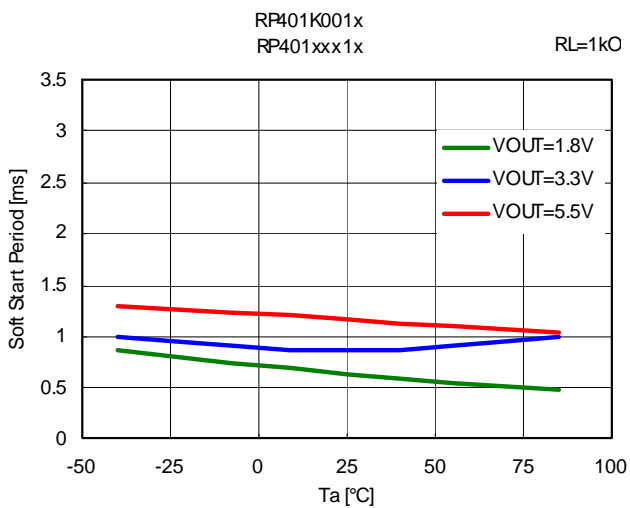

## 9) Soft start time vs. Input voltage (Ta=25°C)

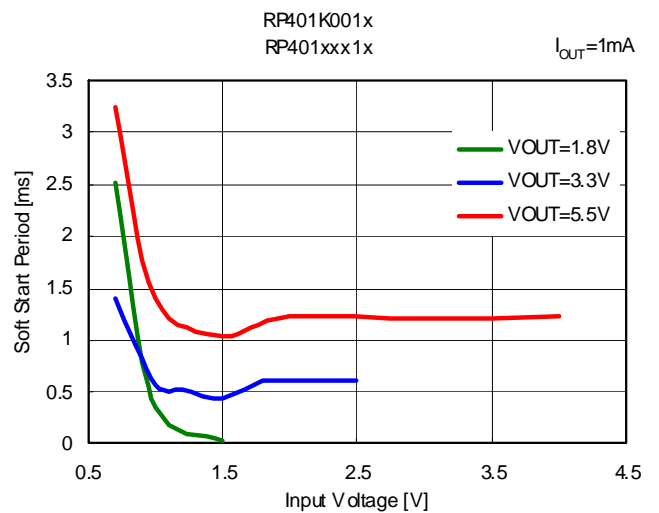

10) Frequency vs. Temperature

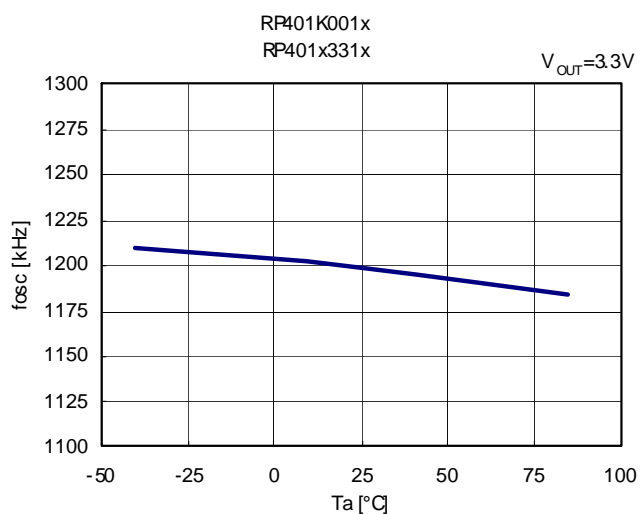

11) Maximum duty cycle vs. Temperature

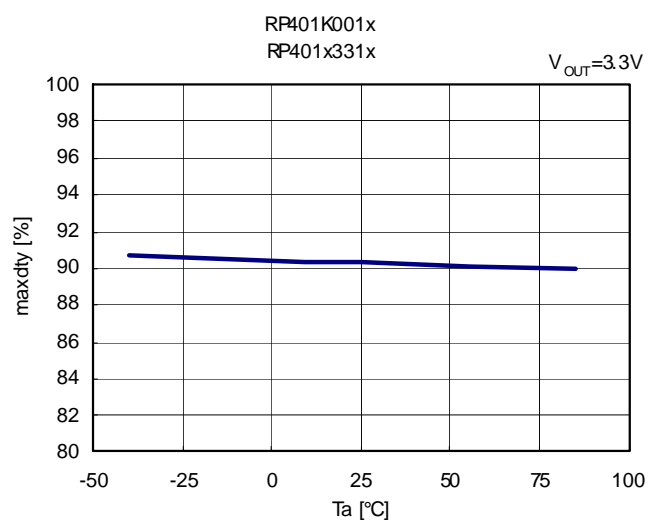

12) Lx current limit vs. duty cycle

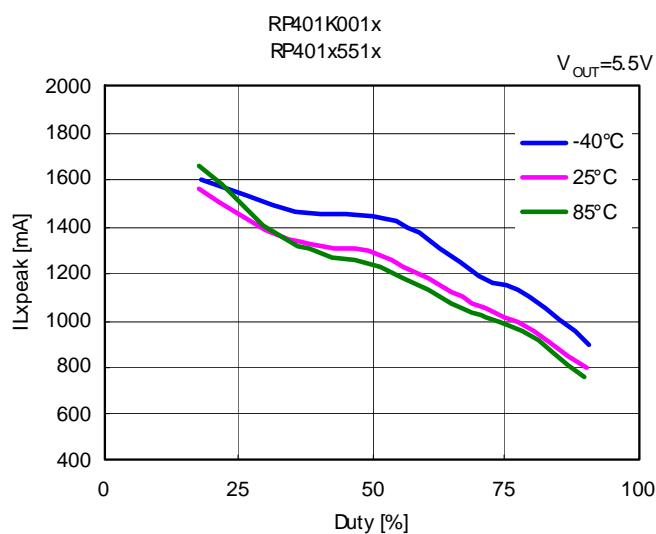
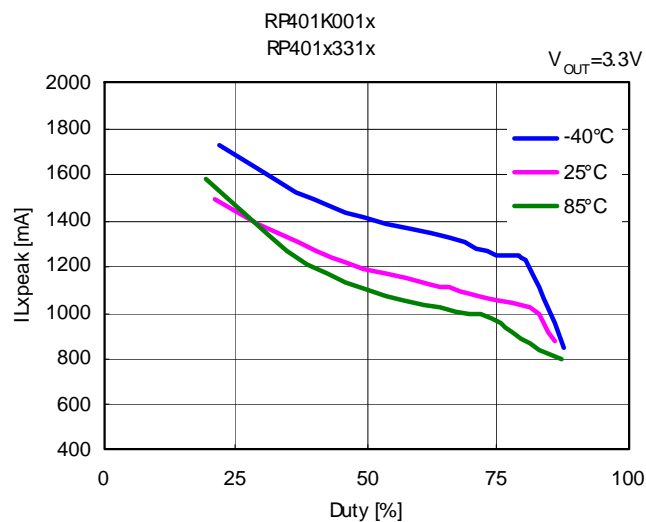
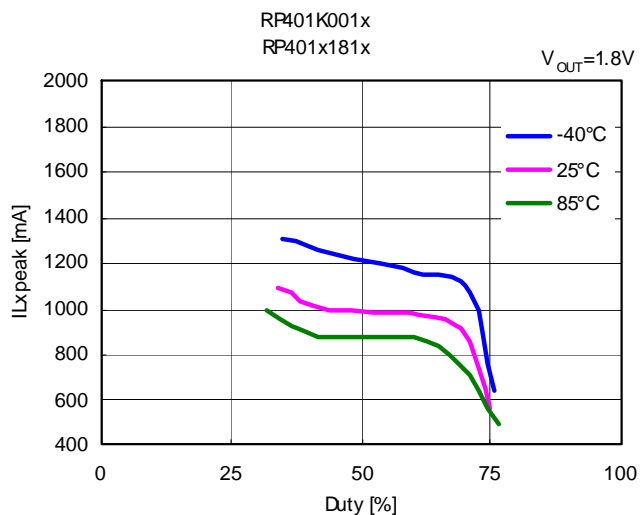

# RP401x

## 13) Lx Current limit vs. Temperature

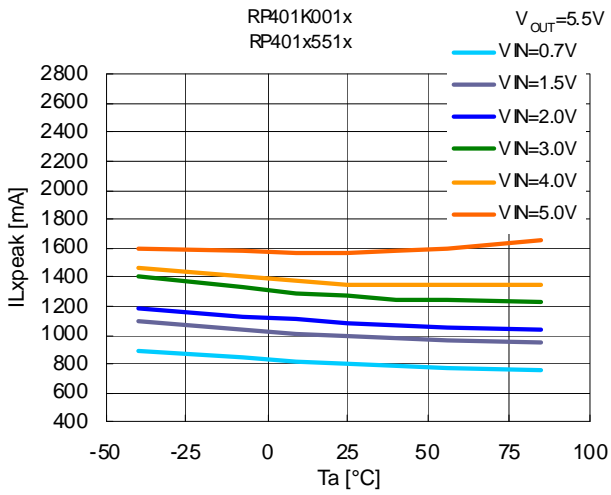
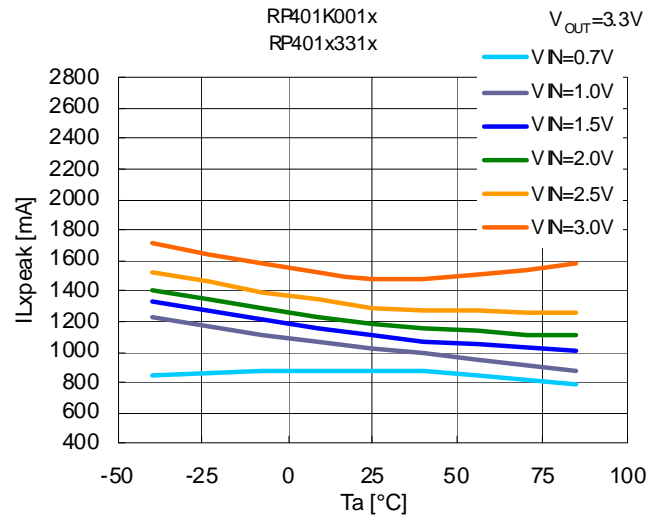
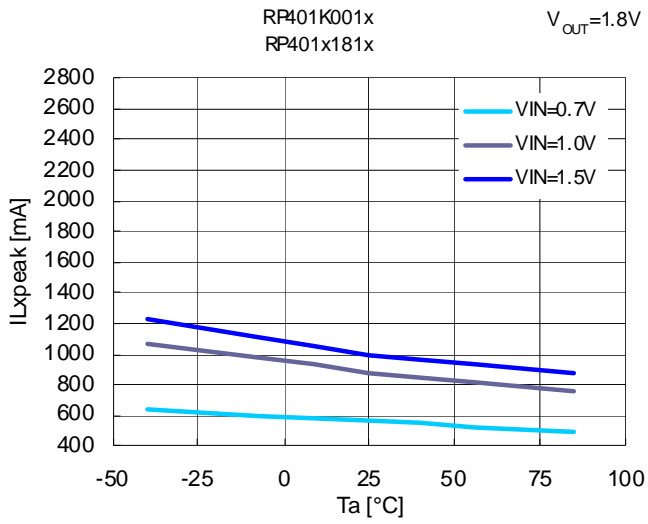

## 14) CE input voltage "H" vs. Temperature

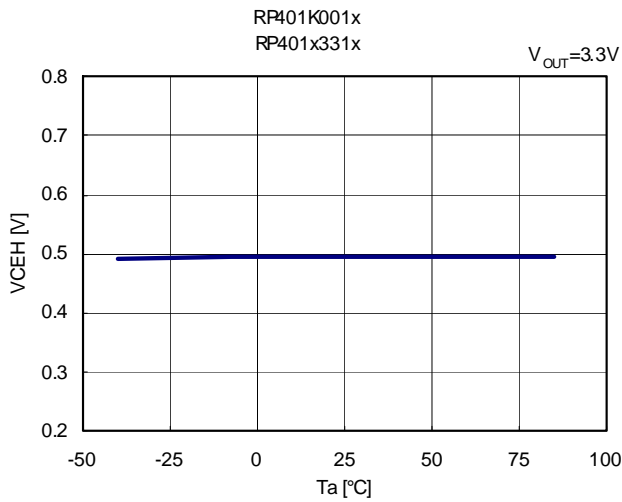

## 15) MODE input voltage "H" vs. Temperature

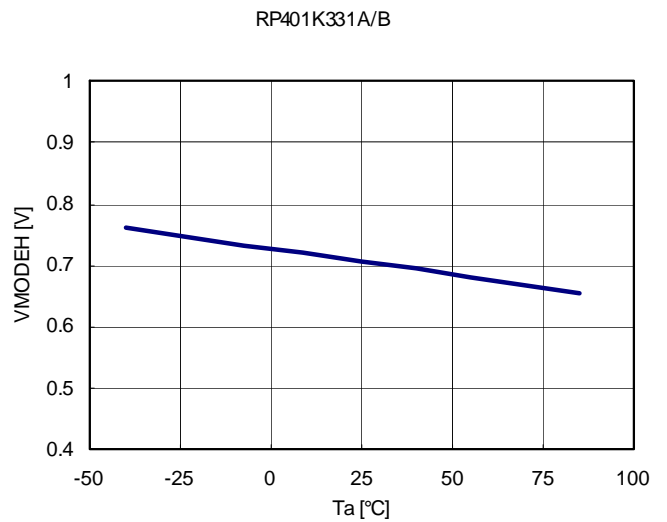

16) Output voltage vs. Temperature

RP401x331x

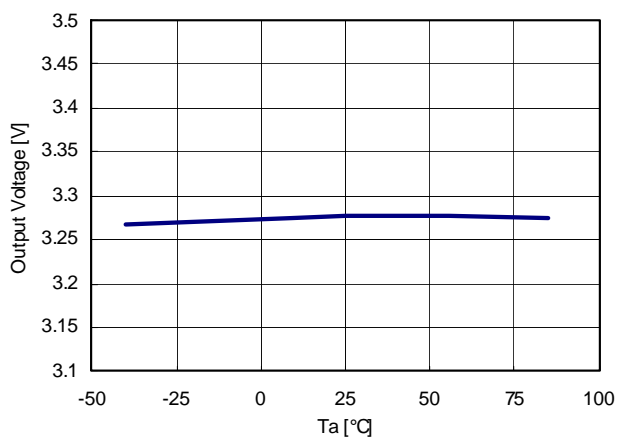

17) Feedback voltage vs. Temperature

RP401K001x

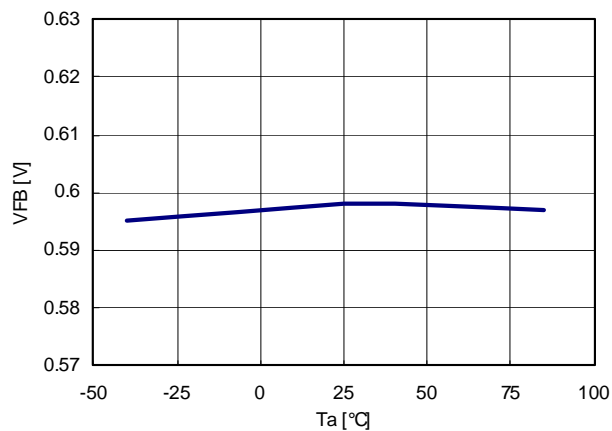

18) Start-up waveform (Ta=25°C)

RP401K001x  
RP401x331x

$V_{OUT}=3.3V$   
 $V_{IN}=2.0V$   $I_{OUT}=1mA$

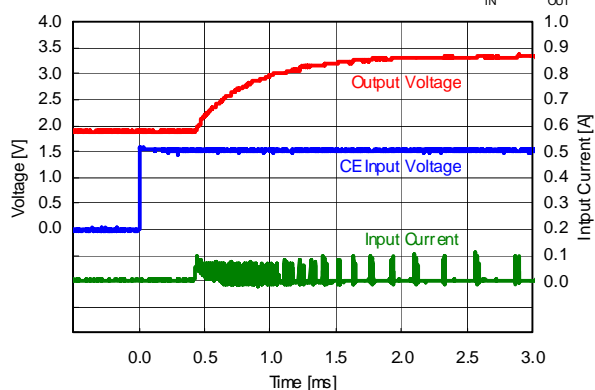

19) Load transient response (Ta=25°C)

RP401K001x  
RP401x331x

$V_{OUT}=3.3V$   
 $V_{IN}=1.5V$  MODE=L

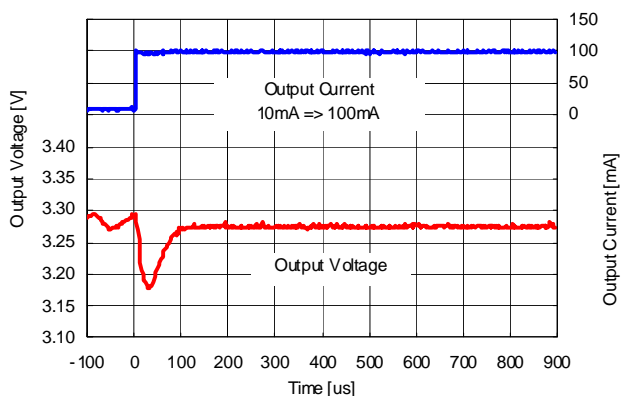

RP401K001x  
RP401x331x

$V_{OUT}=3.3V$   
 $V_{IN}=1.5V$  MODE=L

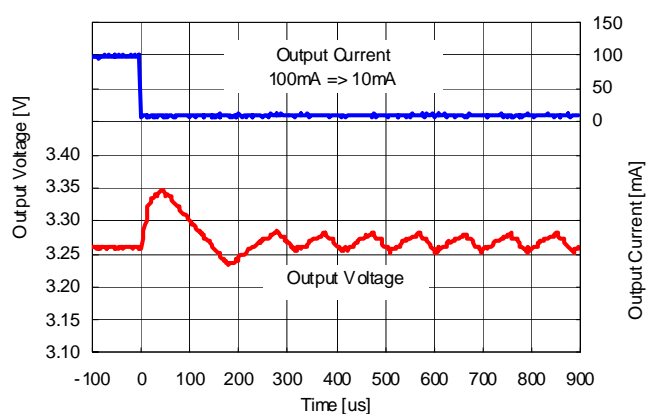

20) Output voltage waveform (Ta=25°C)

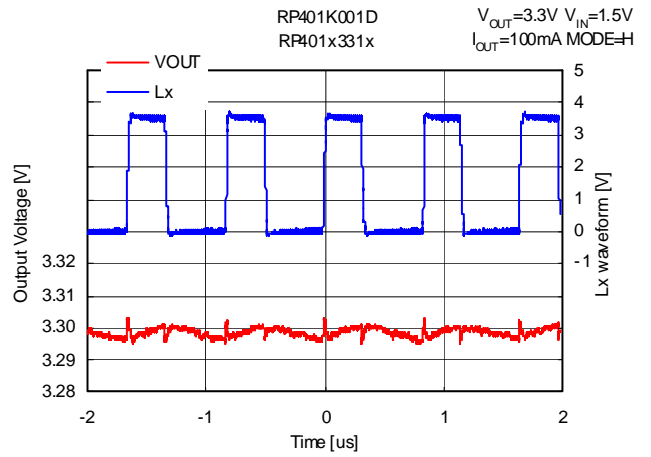
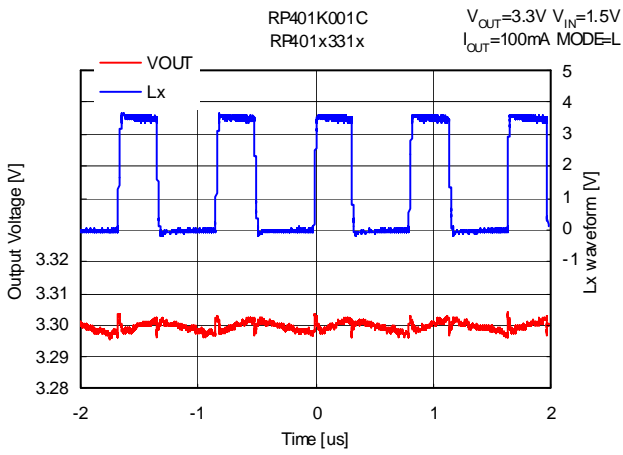
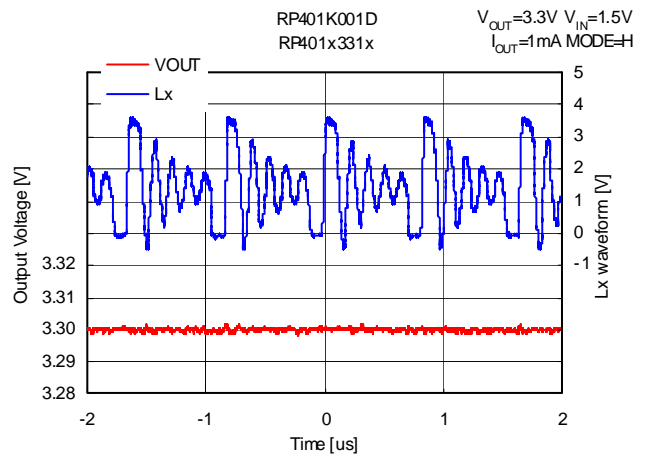
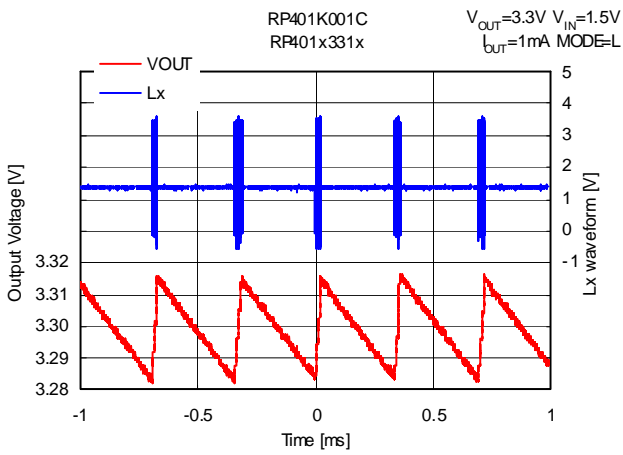

21) Hold-on voltage vs. Temperature

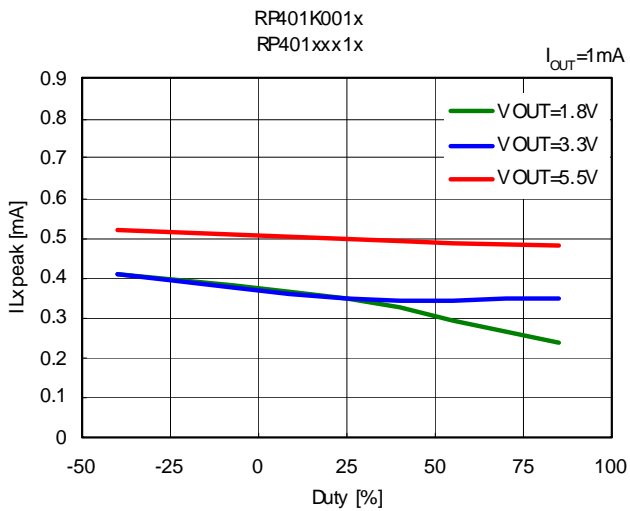

22) Mode alternative waveform (Ta=25°C)

RP401K331A/B

$V_{IN}=1.5V$   $I_{OUT}=0.1mA$

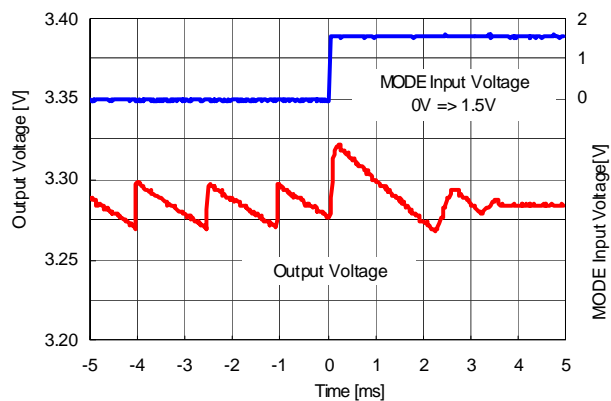

RP401K331A/B

$V_{IN}=1.5V$   $I_{OUT}=0.1mA$

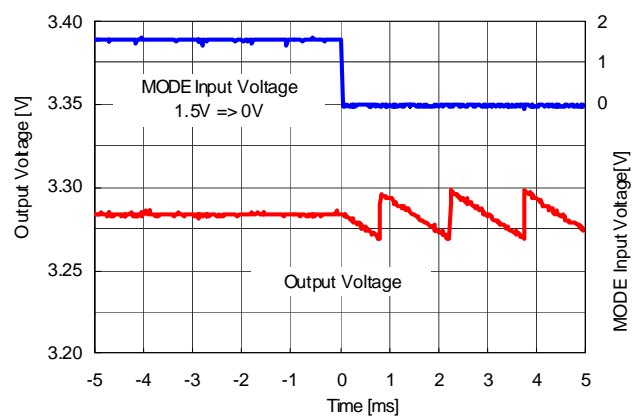

The power dissipation of the package is dependent on PCB material, layout, and environmental conditions. The following conditions are used in this measurement.

**Measurement Conditions**

	<b>Standard Test Land Pattern</b>
Environment	Mounting on Board (Wind Velocity = 0 m/s)
Board Material	Glass Cloth Epoxy Plastic (Double-Sided Board)
Board Dimensions	40 mm × 40 mm × 1.6 mm
Copper Ratio	Top Side: Approx. 50% Bottom Side: Approx. 50%
Through-holes	φ 0.54 mm × 30 pcs

**Measurement Result**

(Ta = 25°C, Tjmax = 125°C)

	<b>Standard Test Land Pattern</b>
Power Dissipation	880 mW
Thermal Resistance	$\theta_{ja} = (125 - 25^\circ\text{C}) / 0.88 \text{ W} = 114^\circ\text{C/W}$

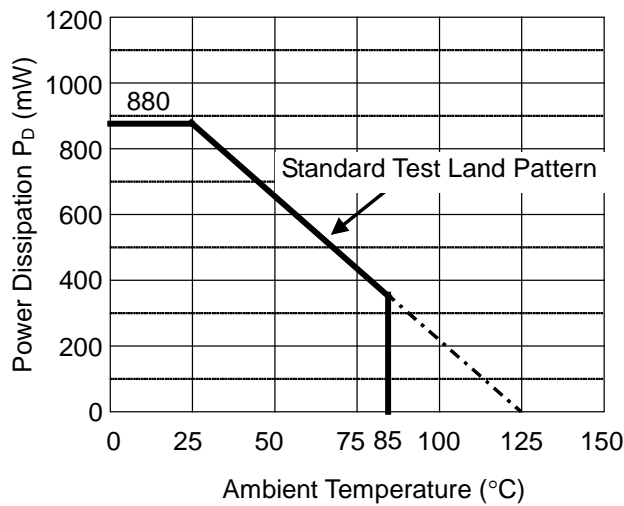

**Power Dissipation vs. Ambient Temperature**

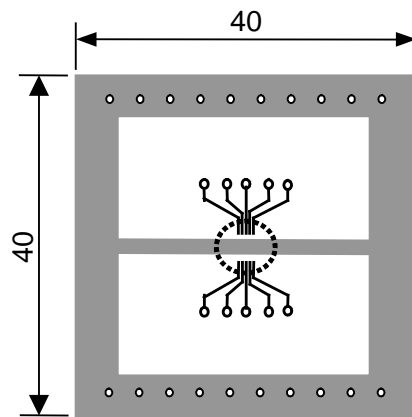

○ IC Mount Area (mm)

**Measurement Board Pattern**



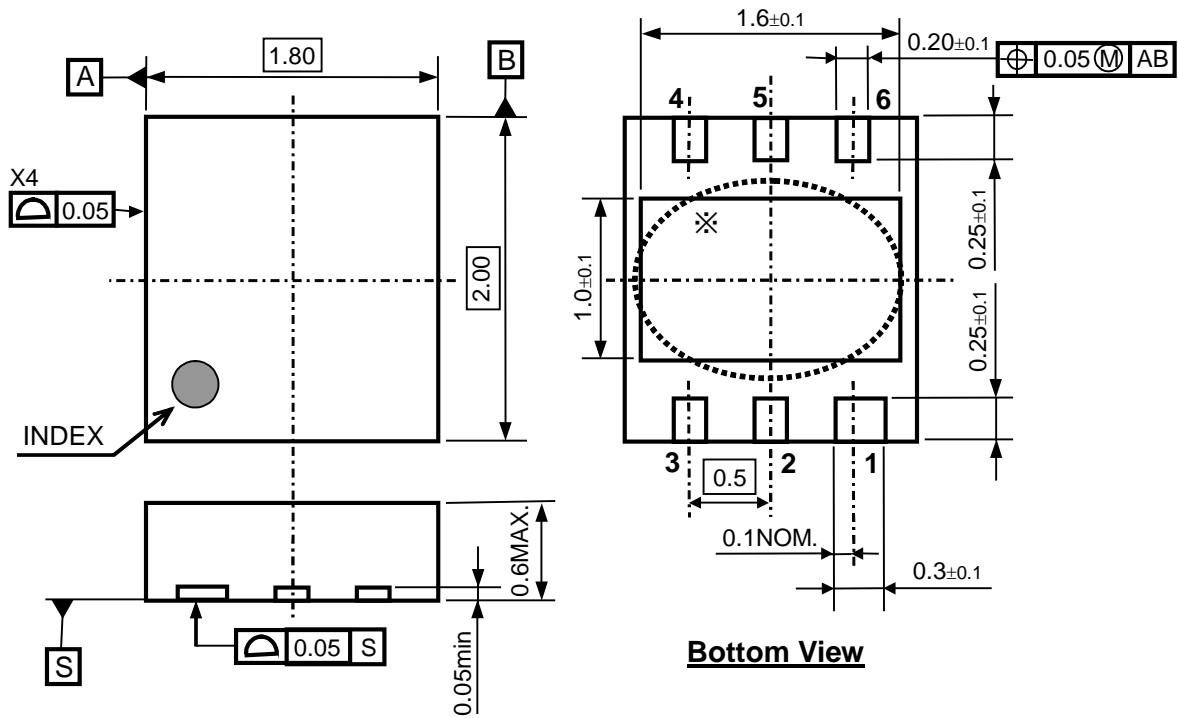

DFN(PLP)1820-6 Package Dimensions (Unit: mm)

\* The tab on the bottom of the package is substrate level (GND). It is recommended that the tab be connected to the ground plane on the board, or otherwise be left floating.



1. The products and the product specifications described in this document are subject to change or discontinuation of production without notice for reasons such as improvement. Therefore, before deciding to use the products, please refer to Ricoh sales representatives for the latest information thereon.
2. The materials in this document may not be copied or otherwise reproduced in whole or in part without prior written consent of Ricoh.
3. Please be sure to take any necessary formalities under relevant laws or regulations before exporting or otherwise taking out of your country the products or the technical information described herein.
4. The technical information described in this document shows typical characteristics of and example application circuits for the products. The release of such information is not to be construed as a warranty of or a grant of license under Ricoh's or any third party's intellectual property rights or any other rights.
5. The products listed in this document are intended and designed for use as general electronic components in standard applications (office equipment, telecommunication equipment, measuring instruments, consumer electronic products, amusement equipment etc.). Those customers intending to use a product in an application requiring extreme quality and reliability, for example, in a highly specific application where the failure or misoperation of the product could result in human injury or death (aircraft, spacevehicle, nuclear reactor control system, traffic control system, automotive and transportation equipment, combustion equipment, safety devices, life support system etc.) should first contact us.
6. We are making our continuous effort to improve the quality and reliability of our products, but semiconductor products are likely to fail with certain probability. In order to prevent any injury to persons or damages to property resulting from such failure, customers should be careful enough to incorporate safety measures in their design, such as redundancy feature, fire containment feature and fail-safe feature. We do not assume any liability or responsibility for any loss or damage arising from misuse or inappropriate use of the products.
7. Anti-radiation design is not implemented in the products described in this document.
8. The X-ray exposure can influence functions and characteristics of the products. Confirm the product functions and characteristics in the evaluation stage.
9. WLCSP products should be used in light shielded environments. The light exposure can influence functions and characteristics of the products under operation or storage.
10. There can be variation in the marking when different AOI (Automated Optical Inspection) equipment is used. In the case of recognizing the marking characteristic with AOI, please contact Ricoh sales or our distributor before attempting to use AOI.
11. Please contact Ricoh sales representatives should you have any questions or comments concerning the products or the technical information.



**Ricoh is committed to reducing the environmental loading materials in electrical devices with a view to contributing to the protection of human health and the environment.**

Ricoh has been providing RoHS compliant products since April 1, 2006 and Halogen-free products since April 1, 2012.

**RICOH** RICOH ELECTRONIC DEVICES CO., LTD.

<https://www.e-devices.ricoh.co.jp/en/>

#### Sales & Support Offices

##### **Ricoh Electronic Devices Co., Ltd.**

##### **Shin-Yokohama Office (International Sales)**

2-3, Shin-Yokohama 3-chome, Kohoku-ku, Yokohama-shi, Kanagawa, 222-8530, Japan  
Phone: +81-50-3814-7687 Fax: +81-45-474-0074

##### **Ricoh Americas Holdings, Inc.**

675 Campbell Technology Parkway, Suite 200 Campbell, CA 95008, U.S.A.  
Phone: +1-408-610-3105

##### **Ricoh Europe (Netherlands) B.V.**

##### **Semiconductor Support Centre**

Prof. W.H. Keesomlaan 1, 1183 DJ Amstelveen, The Netherlands  
Phone: +31-20-5474-309

##### **Ricoh International B.V. - German Branch**

##### **Semiconductor Sales and Support Centre**

Oberrather Strasse 6, 40472 Düsseldorf, Germany  
Phone: +49-211-6546-0

##### **Ricoh Electronic Devices Korea Co., Ltd.**

3F, Haesung Bldg, 504, Teheran-ro, Gangnam-gu, Seoul, 135-725, Korea  
Phone: +82-2-2135-5700 Fax: +82-2-2051-5713

##### **Ricoh Electronic Devices Shanghai Co., Ltd.**

Room 403, No.2 Building, No.690 Bibo Road, Pu Dong New District, Shanghai 201203,  
People's Republic of China  
Phone: +86-21-5027-3200 Fax: +86-21-5027-3299

##### **Ricoh Electronic Devices Shanghai Co., Ltd.**

##### **Shenzhen Branch**

1205, Block D (Jinlong Building), Kingkey 100, Hongbao Road, Luohu District,  
Shenzhen, China  
Phone: +86-755-8348-7600 Ext 225

##### **Ricoh Electronic Devices Co., Ltd.**

##### **Taipei office**

Room 109, 10F-1, No.51, Hengyang Rd., Taipei City, Taiwan (R.O.C.)  
Phone: +886-2-2313-1621/1622 Fax: +886-2-2313-1623