

---

### 0.8% Low Voltage Detector with Output Delay

---

NO.EA-161-140819

#### OUTLINE

The R3116x series are CMOS-based voltage detector ICs with high detector threshold accuracy and ultra-low supply current, which can be operated at an extremely low voltage and is used for system reset as an example.

Each of these ICs consists of a voltage reference unit, a comparator, resistors for detector threshold setting, an output driver, a hysteresis circuit and an output delay circuit. The detector threshold is internally fixed with high accuracy and does not require any adjustment.

Two output types, Nch open drain type and CMOS type are available.

The R3116x series are operable at a lower voltage than that of the R3112x series, and can be driven by a single battery.

Three types of packages, SOT-23-5, SC-82AB, and DFN(PLP)1010-4 are available.

#### FEATURES

- Supply Current ..... Typ. 0.35 $\mu$ A ( $-V_{DET}=1.5V$ ,  $V_{DD}=-V_{DET}+1V$ )
- Operating Voltage Range.....0.5V to 6.0V ( $T_{opt}=25^{\circ}C$ )
- Detector Threshold Range.....0.7V to 5.0V (0.1V step)
- Detector Threshold Accuracy..... $\pm 0.8\%$  ( $-V_{DET} \geq 1.5V$ )
- Temperature-Drift Coefficient of Detector Threshold ..... Typ.  $\pm 30ppm/^{\circ}C$
- Built-in Output Delay Circuit..... Typ. 100ms with an external capacitor: 0.022 $\mu$ F
- Output Delay Time Accuracy..... $\pm 15\%$  ( $-V_{DET} \geq 1.5V$ )
- Output Types.....Nch Open Drain "L" and CMOS
- Packages .....DFN(PLP)1010-4, SC-82AB, SOT-23-5

#### APPLICATIONS

- CPU and Logic Circuit Reset
- Battery Checker
- Window Comparator
- Wave Shaping Circuit
- Battery Back-up Circuit
- Power Failure Detector

**BLOCK DIAGRAMS**

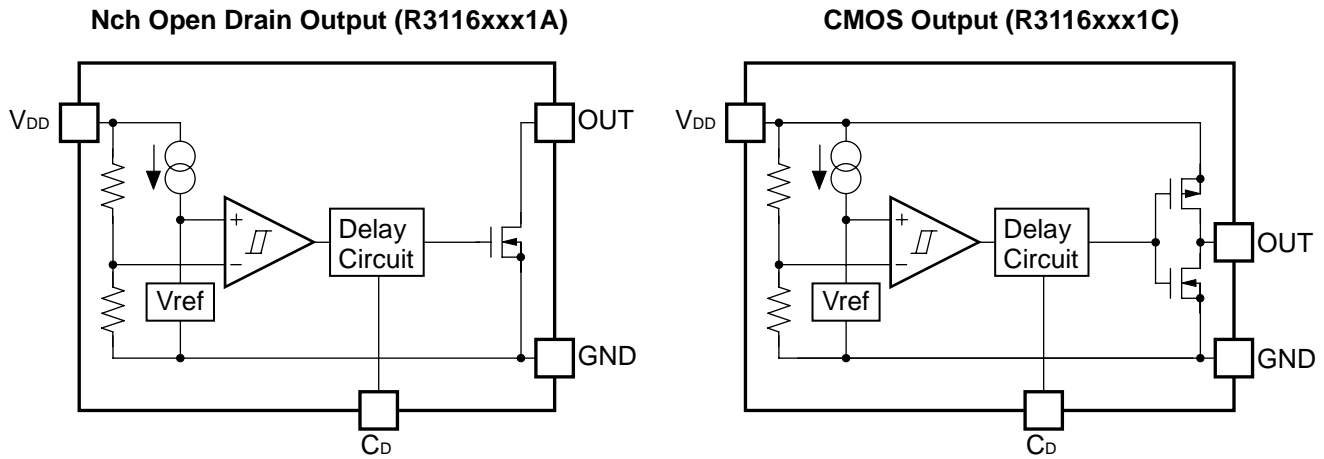

**SELECTION GUIDE**

The package type, the detector threshold, the output type and the taping type for the ICs can be selected at the users' request.

| Product Name     | Package        | Quantity per Reel | Pb Free | Halogen Free |
|------------------|----------------|-------------------|---------|--------------|
| R3116Kxx1*-TR    | DFN(PLP)1010-4 | 10,000 pcs        | Yes     | Yes          |
| R3116Qxx1*-TR-FE | SC-82AB        | 3,000 pcs         | Yes     | Yes          |
| R3116Nxx1*-TR-FE | SOT-23-5       | 3,000 pcs         | Yes     | Yes          |

xx: The detector threshold can be designated in the range from 0.7V(07) to 5.0V(50) in 0.1V step.

\* : Designation of Output Type  
 (A) Nch Open Drain  
 (C) CMOS

## PIN DESCRIPTIONS

### • DFN(PLP)1010-4



### • SOT-23-5



### • SC-82AB



### • DFN(PLP)1010-4

| Pin No. | Symbol          | Description  |
|---------|-----------------|--|
| 1       | OUT             | Output Pin<br>("L" at detection)                         |
| 2       | C <sub>D</sub>  | Pin for External Capacitor<br>(for setting output delay) |
| 3       | GND             | Ground Pin   |
| 4       | V <sub>DD</sub> | Input Pin  |

\*) Tab is GND level. (They are connected to the reverse side of this IC.)

The tab is better to be connected to the GND, but leaving it open is also acceptable.

### • SOT-23-5

| Pin No. | Symbol          | Description  |
|---------|-----------------|--|
| 1       | OUT             | Output Pin<br>("L" at detection)                         |
| 2       | V <sub>DD</sub> | Input Pin  |
| 3       | GND             | Ground Pin   |
| 4       | NC              | No Connection  |
| 5       | C <sub>D</sub>  | Pin for External Capacitor<br>(for setting output delay) |

### • SC-82AB

| Pin No. | Symbol          | Description  |
|---------|-----------------|--|
| 1       | V <sub>DD</sub> | Input Pin  |
| 2       | GND             | Ground Pin   |
| 3       | C <sub>D</sub>  | Pin for External Capacitor<br>(for setting output delay) |
| 4       | OUT             | Output Pin<br>("L" at detection)                         |

**ABSOLUTE MAXIMUM RATINGS**

| Symbol    | Item                                   | Rating                       | Unit |
|-----------|--|------------------------------|------|
| $V_{DD}$  | Supply Voltage                         | 7.0                          | V    |
| $V_{OUT}$ | Output Voltage (Nch Open Drain Output) | $V_{SS}-0.3$ to 7.0          | V    |
|           | Output Voltage (CMOS Output)           | $V_{SS}-0.3$ to $V_{DD}+0.3$ |      |
| $I_{OUT}$ | Output Current                         | 20                           | mA   |
| $P_D$     | Power Dissipation (SOT-23-5)*          | 420                          | mW   |
|           | Power Dissipation (SC-82AB)*           | 380                          |      |
|           | Power Dissipation (DFN(PLP)1010-4)*    | 400                          |      |
| $T_{opt}$ | Operating Temperature Range            | -40 to 85                    | °C   |
| $T_{stg}$ | Storage Temperature Range              | -55 to 125                   | °C   |

\* Please refer to *PACKAGE INFORMATION* for detailed information.

**ABSOLUTE MAXIMUM RATINGS**

Electronic and mechanical stress momentarily exceeded absolute maximum ratings may cause the permanent damages and may degrade the life time and safety for both device and system using the device in the field. The functional operation at or over these absolute maximum ratings is not assured.

**RECOMMENDED OPERATING CONDITIONS (ELECTRICAL CHARACTERISTICS)**

All of electronic equipment should be designed that the mounted semiconductor devices operate within the recommended operating conditions. The semiconductor devices cannot operate normally over the recommended operating conditions, even if when they are used over such conditions by momentary electronic noise or surge. And the semiconductor devices may receive serious damage when they continue to operate over the recommended operating conditions.

## ELECTRICAL CHARACTERISTICS

- R3116xxx1A/C   values indicate  $-40^{\circ}\text{C} \leq T_{\text{opt}} \leq 85^{\circ}\text{C}$ , unless otherwise noted. (T<sub>opt</sub>=25°C)

| Symbol                                    | Item                                       | Conditions   |  | Min.  | Typ.                        | Max.                         | Unit   |    |  |
|---|--|--|--|---|-----------------------------|------------------------------|--------|----|--|
| -V <sub>DET</sub>                         | Detector Threshold                         | T <sub>opt</sub> =25°C   | 1.5V < -V <sub>DET</sub> ≤ 5.0V                | -V <sub>DET</sub><br>× 0.992                  |                             | -V <sub>DET</sub><br>× 1.008 | V      |    |  |
|   |  |  | 0.7V ≤ -V <sub>DET</sub> ≤ 1.5V                | -12   |                             | +12                          | mV     |    |  |
|   |  | -40°C ≤ T <sub>opt</sub> ≤ 85°C  | 1.5V < -V <sub>DET</sub> ≤ 5.0V                | -V <sub>DET</sub><br>× 0.985                  |                             | -V <sub>DET</sub><br>× 1.015 | V      |    |  |
|   |  |  | 0.7V ≤ -V <sub>DET</sub> ≤ 1.5V                | -22.5   |                             | +22.5                        | mV     |    |  |
| V <sub>HYS</sub>                          | Detector Threshold Hysteresis              |  | -V <sub>DET</sub><br>× 0.04                    |   | -V <sub>DET</sub><br>× 0.07 | V                            |        |    |  |
| I <sub>SS</sub>                           | Supply Current                             | V <sub>DD</sub> =-V <sub>DET</sub> -0.1V   | 0.7V ≤ -V <sub>DET</sub> < 1.6V                |   |                             | 1.400                        | μA     |    |  |
|   |  |  | 1.6V ≤ -V <sub>DET</sub> < 3.1V                |   |                             | 1.500                        |        |    |  |
|   |  |  | 3.1V ≤ -V <sub>DET</sub> < 4.1V                |   |                             | 1.600                        |        |    |  |
|   |  |  | 4.1V ≤ -V <sub>DET</sub> ≤ 5.0V                |   |                             | 1.700                        |        |    |  |
|   |  | V <sub>DD</sub> =-V <sub>DET</sub> +1.0V   | 0.7V ≤ -V <sub>DET</sub> < 1.6V                |   |                             | 1.200                        |        |    |  |
|   |  |  | 1.6V ≤ -V <sub>DET</sub> < 3.1V                |   |                             | 1.200                        |        |    |  |
|   |  |  | 3.1V ≤ -V <sub>DET</sub> < 4.1V                |   |                             | 1.300                        |        |    |  |
|   |  |  | 4.1V ≤ -V <sub>DET</sub> ≤ 5.0V                |   |                             | 1.400                        |        |    |  |
| V <sub>DDH</sub>                          | Maximum Operating Voltage                  |  |  |   | 6                           | V                            |        |    |  |
| V <sub>DDL</sub>                          | Minimum Operating Voltage*1                | T <sub>opt</sub> =25°C   |  |   |                             | 0.50                         | V      |    |  |
|   |  | -40°C ≤ T <sub>opt</sub> ≤ 85°C  |  |   |                             | 0.55                         |        |    |  |
| I <sub>OUT</sub>                          | Output Current<br>(Driver Output Pin)      | Nch  | V <sub>DD</sub> =0.55V, V <sub>DS</sub> =0.05V |   | 7                           |                              | μA     |    |  |
|   |  |  | 0.7V ≤ -V <sub>DET</sub> < 1.1V                | V <sub>DD</sub> =0.6V, V <sub>DS</sub> =0.5V  | 0.020                       |                              | mA     |    |  |
|   |  |  | 1.1V ≤ -V <sub>DET</sub> < 1.6V                | V <sub>DD</sub> =1.0V, V <sub>DS</sub> =0.5V  | 0.400                       |                              |        |    |  |
|   |  |  | 1.6V ≤ -V <sub>DET</sub> < 3.1V                | V <sub>DD</sub> =1.5V, V <sub>DS</sub> =0.5V  | 1.000                       |                              |        |    |  |
|   |  |  | 3.1V ≤ -V <sub>DET</sub> ≤ 5.0V                | V <sub>DD</sub> =3.0V, V <sub>DS</sub> =0.5V  | 2.400                       |                              |        |    |  |
|   |  | Pch*2  | 0.7V ≤ -V <sub>DET</sub> < 4.0V                | V <sub>DD</sub> =4.5V, V <sub>DS</sub> =-2.1V | 0.650                       |                              | mA     |    |  |
|   |  |  | 4.0V ≤ -V <sub>DET</sub> ≤ 5.0V                | V <sub>DD</sub> =6.0V, V <sub>DS</sub> =-2.1V | 0.900                       |                              |        |    |  |
|   |  |  |  |   |                             |                              |        |    |  |
| I <sub>LEAK</sub>                         | Nch Driver Leakage Current*3               | V <sub>DD</sub> =6.0V, V <sub>DS</sub> =7.0V   |  |   |                             | 80                           | nA     |    |  |
| Δ-V <sub>DET</sub> /<br>ΔT <sub>opt</sub> | Detector Threshold Temperature Coefficient |  |  |   | ±30                         |                              | ppm/°C |    |  |
| t <sub>o</sub>                            | Output Delay Time                          | C <sub>D</sub> =0.022μF<br>V <sub>DD</sub> =-V <sub>DET</sub> -0.1V<br>to -V <sub>DET</sub> × 1.1V | T <sub>opt</sub> =25°C                         | 0.7V ≤ -V <sub>DET</sub> < 1.5V               | 80                          | 100                          | 130    | ms |  |
|   |  |  |  | 1.5V ≤ -V <sub>DET</sub> ≤ 5.0V               | 85                          |                              | 115    |    |  |
|   |  |  | -40°C ≤<br>T <sub>opt</sub> ≤ 85°C             | 0.7V ≤ -V <sub>DET</sub> < 1.5V               | 70                          | 100                          | 150    |    |  |
|   |  |  |  | 1.5V ≤ -V <sub>DET</sub> ≤ 5.0V               | 75                          |                              | 135    |    |  |
|   |  |  |  |   |                             |                              |        |    |  |
|   |  |  |  |   |                             |                              |        |    |  |

All of unit are tested and specified under load conditions such that T<sub>opt</sub>=25°C except for Detector Threshold Temperature Coefficient.

\*1: Minimum operating voltage means the value of input voltage when output voltage maintains 0.1V or less.  
(In case of Nch Open Drain Output type, the output pin is pulled up with a resistance of 470kΩ to 5.0V)

\*2: In case of CMOS type

\*3: In case of Nch Open Drain type

## TIMING CHART



When the supply voltage, which is higher than released voltage, is forced to V<sub>DD</sub> pin, charge to an external capacitor starts, then C<sub>D</sub> pin voltage increases. Until the C<sub>D</sub> pin voltage reaches to C<sub>D</sub> pin threshold voltage, output voltage maintains "L". When the C<sub>D</sub> pin voltage becomes higher than C<sub>D</sub> pin threshold voltage, output voltage is reversed from "L" to "H". Where the time interval between the rising edge of supply voltage and output voltage reverse point means output delay time.

When the output voltage reverses from "L" to "H", the external capacitor starts to discharge. Therefore, when lower voltage than the detector threshold voltage is forced to V<sub>DD</sub> pin, the output voltage reverses from "H" to "L" thus the detect delay time is constant not being affected by the external capacitor.

### • Output Delay Time

Output Delay Time (t<sub>b</sub>) can be calculated with the next formula using the external capacitor:

$$t_b(s) = 4.5 \times 10^6 \times C_D(F)$$

## DEFINITION OF OUTPUT DELAY TIME

Output Delay Time (t<sub>b</sub>) is defined as follows:

1. In the case of Nch Open Drain Output:

Under the condition of the output pin (OUT) is pulled up through a resistor of 470kΩ to 5V, the time interval between the rising edge of V<sub>DD</sub> pulse from (-V<sub>DET</sub>)-0.1V to (-V<sub>DET</sub>)×1.1V pulse voltage is supplied, the becoming of the output voltage to 2.5V.

2. In the case of CMOS Output:

The time interval between the rising edge of V<sub>DD</sub> pulse from (-V<sub>DET</sub>)-0.1V to (-V<sub>DET</sub>)×1.1V pulse voltage is supplied, the becoming of the output voltage to ((-V<sub>DET</sub>)×1.1V)/2.

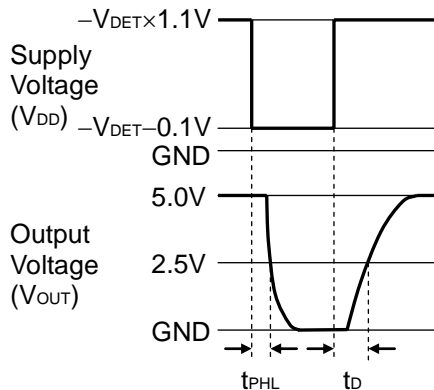

**Nch Open Drain Output  
(R3116xxx1A)**

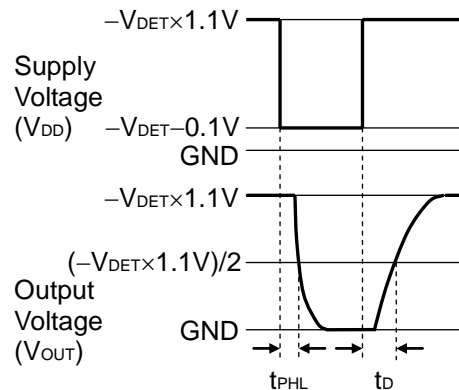

**CMOS Output  
(R3116xxx1C)**

## ELECTRICAL CHARACTERISTICS BY DETECTOR THRESHOLD

### • R3116x071A/C to R3116x501A/C

**Bold values** are checked and guaranteed by design engineering at  $-40^{\circ}\text{C} \leq T_{\text{opt}} \leq 85^{\circ}\text{C}$ , unless otherwise noted.

( $T_{\text{opt}}=25^{\circ}\text{C}$ )

| Part Number  | Detector Threshold1    |       | Detector Threshold2    |              | Detector Threshold Hysteresis |              | Supply Current1                                 |              | Supply Current2       |      | Max. Op. Voltage     | Min. Op. Voltage     |
|--------------|------------------------|-------|------------------------|--------------|-------------------------------|--------------|---|--------------|-----------------------|------|----------------------|----------------------|
|              | -V <sub>DET1</sub> [V] |       | -V <sub>DET2</sub> [V] |              | V <sub>HYS</sub> [V]          |              | I <sub>SS1</sub> [μA]                           |              | I <sub>SS2</sub> [μA] |      | V <sub>DDH</sub> [V] | V <sub>DDL</sub> [V] |
|              | Min.                   | Max.  | Min.                   | Max.         | Min.                          | Max.         | Cond.   | Max.         | Cond.                 | Max. | Max.                 | Max.                 |
| R3116x071A/C | 0.688                  | 0.712 | <b>0.678</b>           | <b>0.723</b> | <b>0.028</b>                  | <b>0.049</b> | V <sub>DD</sub> =<br>-V <sub>DET</sub><br>-0.1V | <b>1.400</b> |                       |      |                      | 0.50                 |
| R3116x081A/C | 0.788                  | 0.812 | <b>0.778</b>           | <b>0.823</b> | <b>0.032</b>                  | <b>0.056</b> |   |              |                       |      |                      |                      |
| R3116x091A/C | 0.888                  | 0.912 | <b>0.878</b>           | <b>0.923</b> | <b>0.036</b>                  | <b>0.063</b> |   |              |                       |      |                      |                      |
| R3116x101A/C | 0.988                  | 1.012 | <b>0.978</b>           | <b>1.023</b> | <b>0.040</b>                  | <b>0.070</b> |   |              |                       |      |                      |                      |
| R3116x111A/C | 1.088                  | 1.112 | <b>1.078</b>           | <b>1.123</b> | <b>0.044</b>                  | <b>0.077</b> |   |              |                       |      |                      |                      |
| R3116x121A/C | 1.188                  | 1.212 | <b>1.178</b>           | <b>1.223</b> | <b>0.048</b>                  | <b>0.084</b> |   |              |                       |      |                      |                      |
| R3116x131A/C | 1.288                  | 1.312 | <b>1.278</b>           | <b>1.323</b> | <b>0.052</b>                  | <b>0.091</b> |   |              |                       |      |                      |                      |
| R3116x141A/C | 1.388                  | 1.412 | <b>1.378</b>           | <b>1.423</b> | <b>0.056</b>                  | <b>0.098</b> |   |              |                       |      |                      |                      |
| R3116x151A/C | 1.488                  | 1.512 | <b>1.478</b>           | <b>1.523</b> | <b>0.060</b>                  | <b>0.105</b> |   |              |                       |      |                      |                      |
| R3116x161A/C | 1.587                  | 1.613 | <b>1.576</b>           | <b>1.624</b> | <b>0.064</b>                  | <b>0.112</b> |   |              |                       |      |                      |                      |
| R3116x171A/C | 1.686                  | 1.714 | <b>1.675</b>           | <b>1.726</b> | <b>0.068</b>                  | <b>0.119</b> |   |              |                       |      |                      |                      |
| R3116x181A/C | 1.786                  | 1.814 | <b>1.773</b>           | <b>1.827</b> | <b>0.072</b>                  | <b>0.126</b> |   |              |                       |      |                      |                      |
| R3116x191A/C | 1.885                  | 1.915 | <b>1.872</b>           | <b>1.929</b> | <b>0.076</b>                  | <b>0.133</b> |   |              |                       |      |                      |                      |
| R3116x201A/C | 1.984                  | 2.016 | <b>1.970</b>           | <b>2.030</b> | <b>0.080</b>                  | <b>0.140</b> |   |              |                       |      |                      |                      |
| R3116x211A/C | 2.083                  | 2.117 | <b>2.069</b>           | <b>2.132</b> | <b>0.084</b>                  | <b>0.147</b> |   |              |                       |      |                      |                      |
| R3116x221A/C | 2.182                  | 2.218 | <b>2.167</b>           | <b>2.233</b> | <b>0.088</b>                  | <b>0.154</b> |   |              |                       |      |                      |                      |
| R3116x231A/C | 2.282                  | 2.318 | <b>2.266</b>           | <b>2.335</b> | <b>0.092</b>                  | <b>0.161</b> |   |              |                       |      |                      |                      |
| R3116x241A/C | 2.381                  | 2.419 | <b>2.364</b>           | <b>2.436</b> | <b>0.096</b>                  | <b>0.168</b> |   |              |                       |      |                      |                      |
| R3116x251A/C | 2.480                  | 2.520 | <b>2.463</b>           | <b>2.538</b> | <b>0.100</b>                  | <b>0.175</b> |   |              |                       |      |                      |                      |
| R3116x261A/C | 2.579                  | 2.621 | <b>2.561</b>           | <b>2.639</b> | <b>0.104</b>                  | <b>0.182</b> |   |              |                       |      |                      |                      |
| R3116x271A/C | 2.678                  | 2.722 | <b>2.660</b>           | <b>2.741</b> | <b>0.108</b>                  | <b>0.189</b> |   |              |                       |      |                      |                      |
| R3116x281A/C | 2.778                  | 2.822 | <b>2.758</b>           | <b>2.842</b> | <b>0.112</b>                  | <b>0.196</b> |   |              |                       |      |                      |                      |
| R3116x291A/C | 2.877                  | 2.923 | <b>2.857</b>           | <b>2.944</b> | <b>0.116</b>                  | <b>0.203</b> |   |              |                       |      |                      |                      |
| R3116x301A/C | 2.976                  | 3.024 | <b>2.955</b>           | <b>3.045</b> | <b>0.120</b>                  | <b>0.210</b> |   |              |                       |      |                      |                      |
| R3116x311A/C | 3.075                  | 3.125 | <b>3.054</b>           | <b>3.147</b> | <b>0.124</b>                  | <b>0.217</b> |   |              |                       |      |                      |                      |
| R3116x321A/C | 3.174                  | 3.226 | <b>3.152</b>           | <b>3.248</b> | <b>0.128</b>                  | <b>0.224</b> |   |              |                       |      |                      |                      |
| R3116x331A/C | 3.274                  | 3.326 | <b>3.251</b>           | <b>3.350</b> | <b>0.132</b>                  | <b>0.231</b> |   |              |                       |      |                      |                      |
| R3116x341A/C | 3.373                  | 3.427 | <b>3.349</b>           | <b>3.451</b> | <b>0.136</b>                  | <b>0.238</b> |   |              |                       |      |                      |                      |
| R3116x351A/C | 3.472                  | 3.528 | <b>3.448</b>           | <b>3.553</b> | <b>0.140</b>                  | <b>0.245</b> |   |              |                       |      |                      |                      |
| R3116x361A/C | 3.571                  | 3.629 | <b>3.546</b>           | <b>3.654</b> | <b>0.144</b>                  | <b>0.252</b> |   |              |                       |      |                      |                      |
| R3116x371A/C | 3.670                  | 3.730 | <b>3.645</b>           | <b>3.756</b> | <b>0.148</b>                  | <b>0.259</b> |   |              |                       |      |                      |                      |
| R3116x381A/C | 3.770                  | 3.830 | <b>3.743</b>           | <b>3.857</b> | <b>0.152</b>                  | <b>0.266</b> |   |              |                       |      |                      |                      |
| R3116x391A/C | 3.869                  | 3.931 | <b>3.842</b>           | <b>3.959</b> | <b>0.156</b>                  | <b>0.273</b> |   |              |                       |      |                      |                      |
| R3116x401A/C | 3.968                  | 4.032 | <b>3.940</b>           | <b>4.060</b> | <b>0.160</b>                  | <b>0.280</b> |   |              |                       |      |                      |                      |
| R3116x411A/C | 4.067                  | 4.133 | <b>4.039</b>           | <b>4.162</b> | <b>0.164</b>                  | <b>0.287</b> |   |              |                       |      |                      |                      |
| R3116x421A/C | 4.166                  | 4.234 | <b>4.137</b>           | <b>4.263</b> | <b>0.168</b>                  | <b>0.294</b> |   |              |                       |      |                      |                      |
| R3116x431A/C | 4.266                  | 4.334 | <b>4.236</b>           | <b>4.365</b> | <b>0.172</b>                  | <b>0.301</b> |   |              |                       |      |                      |                      |
| R3116x441A/C | 4.365                  | 4.435 | <b>4.334</b>           | <b>4.466</b> | <b>0.176</b>                  | <b>0.308</b> |   |              |                       |      |                      |                      |
| R3116x451A/C | 4.464                  | 4.536 | <b>4.433</b>           | <b>4.568</b> | <b>0.180</b>                  | <b>0.315</b> |   |              |                       |      |                      |                      |
| R3116x461A/C | 4.563                  | 4.637 | <b>4.531</b>           | <b>4.669</b> | <b>0.184</b>                  | <b>0.322</b> |   |              |                       |      |                      |                      |
| R3116x471A/C | 4.662                  | 4.738 | <b>4.630</b>           | <b>4.771</b> | <b>0.188</b>                  | <b>0.329</b> |   |              |                       |      |                      |                      |
| R3116x481A/C | 4.762                  | 4.838 | <b>4.728</b>           | <b>4.872</b> | <b>0.192</b>                  | <b>0.336</b> |   |              |                       |      |                      |                      |
| R3116x491A/C | 4.861                  | 4.939 | <b>4.827</b>           | <b>4.974</b> | <b>0.196</b>                  | <b>0.343</b> |   |              |                       |      |                      |                      |
| R3116x501A/C | 4.960                  | 5.040 | <b>4.925</b>           | <b>5.075</b> | <b>0.200</b>                  | <b>0.350</b> |   |              |                       |      |                      |                      |

\*Note1) V<sub>DD</sub> value when output voltage is equal or less than 0.1V. In the case of Nch Open Drain output type, the output pin is pulled up to 5.0V through 470kΩ resistor.

# R3116x

NO.EA-161-140819

| Nch Driver Output Current1                                   |      | Nch Driver Output Current2                                  |       | Pch Driver Output Current                                   |       | Nch Driver Leakage Current                                 |      | Detector Threshold Temperature Coefficient | Output Delay Time   |      |      |
|--|------|---|-------|---|-------|--|------|--|---|------|------|
| IOUT1 [μA]   |      | IOUT2 [mA]  |       | IOUT3 [mA]  |       | ILEAK [nA]   |      | $\Delta-V_{DET}/\Delta T_{opt}$ [ppm/°C]   | td [ms]   |      |      |
| Cond.  | Min. | Cond.   | Min.  | Cond.   | Min.  | Cond.  | Max. | Typ.                                       | Cond.   | Min. | Max. |
| V <sub>DD</sub> =<br>0.55V<br><br>V <sub>DS</sub> =<br>0.05V | 7    | V <sub>DD</sub> =<br>0.6V<br>V <sub>DS</sub> =<br>0.5V      | 0.020 | V <sub>DD</sub> =<br>4.5V<br><br>V <sub>DS</sub> =<br>-2.1V | 0.650 | V <sub>DD</sub> =<br>6.0V<br><br>V <sub>DS</sub> =<br>7.0V | 80   | ±30  | C <sub>D</sub> =<br>0.022μF<br><br>V <sub>DD</sub> =<br>-V <sub>DET</sub><br>-0.1V<br>↓<br>-V <sub>DET</sub><br>×1.1V<br><br>*Note2 | 80   | 130  |
|  |      | V <sub>DD</sub> =<br>1.0V<br><br>V <sub>DS</sub> =<br>0.5V  | 0.400 |   |       |  |      |  |   | 70   | 150  |
|  |      | V <sub>DD</sub> =<br>1.5V<br><br>V <sub>DS</sub> =<br>0.5V  | 1.000 |   |       |  |      |  |   | 85   | 115  |
|  |      | V <sub>DD</sub> =<br>3.0V<br><br>V <sub>DS</sub> =<br>0.5V  | 2.400 |   |       |  |      |  |   | 75   | 135  |
|  |      | V <sub>DD</sub> =<br>6.0V<br><br>V <sub>DS</sub> =<br>-2.1V | 0.900 |   |       |  |      |  |   |      |      |

\*Note2) 1. In the case of CMOS output type:  
When the voltage is forced from (-V<sub>DET</sub>)-0.1V to (-V<sub>DET</sub>)×1.1V pulse voltage is added to V<sub>DD</sub>, time interval that the output voltage reaches ((-V<sub>DET</sub>)×1.1V)/2.

2. In the case of Nch Open Drain output type:  
The output pin is pulled up to 5.0V through 470kΩ, and when the voltage is forced from (-V<sub>DET</sub>)-0.1V to (-V<sub>DET</sub>)×1.1V pulse voltage is added to V<sub>DD</sub>, time interval that the output voltage reaches 2.5V.



## TYPICAL APPLICATION

### • R3116xxx1A CPU Reset Circuit 1 (Nch Open Drain Output)

Case1. Input Voltage to R3116xxx1A is equal to Input Voltage to CPU

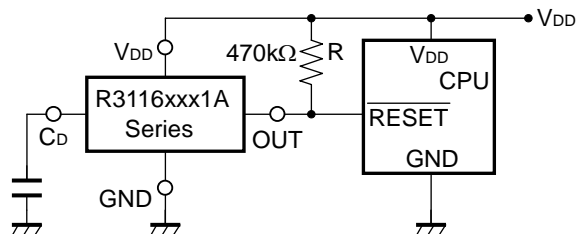

Case2. Input Voltage to R3116xxx1A is unequal to Input Voltage to CPU

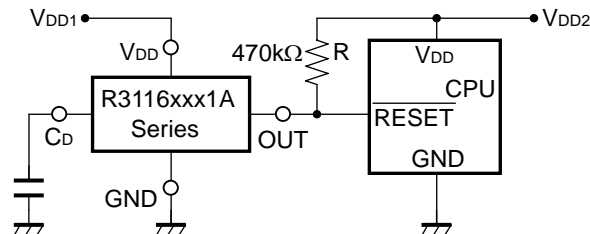

### • R3116xxx1C CPU Reset Circuit 2 (CMOS Output)

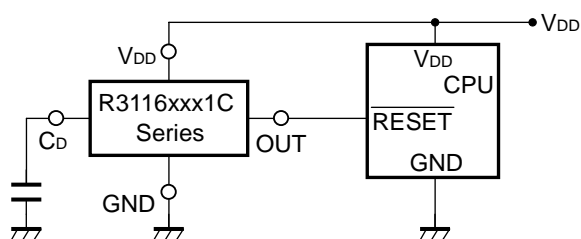

### • Memory Back-up Circuit

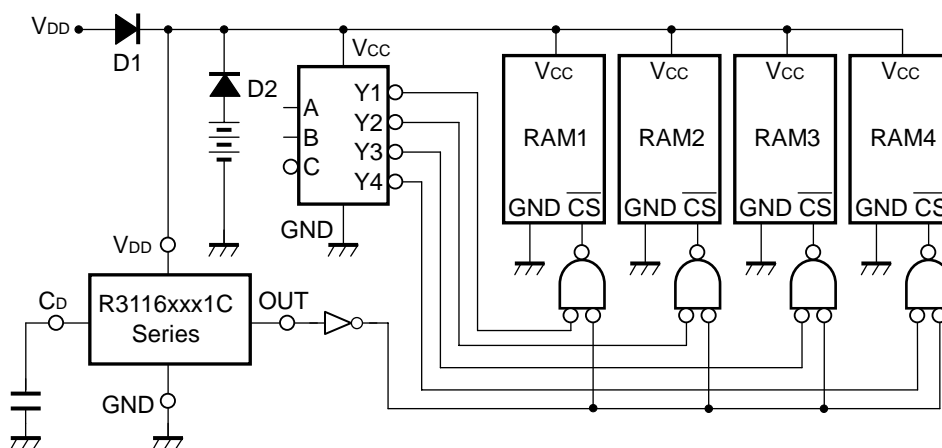

## R3116x

NO.EA-161-140819

- **Voltage level Indicator Circuit (lighted when the power runs out)  
(Nch Open Drain Output)**



- **Detector Threshold Adjustable Circuit 1  
(Nch Open Drain Output)**

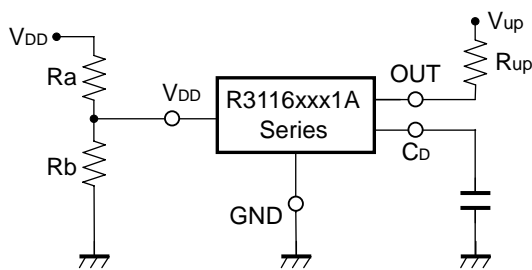

$$\text{Adjustable Detector Threshold} = (-V_{\text{DET}}) \times (R_a + R_b) / R_b$$

$$\text{Hysteresis Voltage} = (V_{\text{HYS}}) \times (R_a + R_b) / R_b$$

- \*1) To prevent oscillation, set  $R_a \leq 1\text{k}\Omega$ ,  $R_b \leq 100\Omega$ .
- \*2) If the value of  $R_a$  is set excessively large, voltage drop may occur caused by the supply current of IC itself, and detector threshold and hysteresis voltage may vary.
- \*3) If  $V_{\text{up}}$  and  $V_{\text{DD}}$  are connected, the voltage dropdown caused by  $R_{\text{up}}$ , may cause difference in the hysteresis voltage.

- **Detector Threshold Adjustable Circuit 2  
(Nch Open Drain Output)**

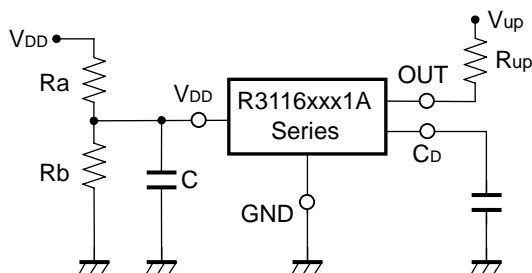

$$\text{Adjustable Detector Threshold} = (-V_{\text{DET}}) \times (R_a + R_b) / R_b$$

$$\text{Hysteresis Voltage} = (V_{\text{HYS}}) \times (R_a + R_b) / R_b$$

- \*1) To prevent oscillation, set  $R_a \leq 10\text{k}\Omega$ ,  $R_b \leq 1\text{k}\Omega$ ,  $C \geq 1\mu\text{F}$ .
- \*2) If the value of  $R_a$  is set excessively large, voltage drop may occur caused by the supply current of IC itself, and detector threshold and hysteresis voltage may vary.
- \*3) If  $V_{\text{up}}$  and  $V_{\text{DD}}$  are connected, the voltage dropdown caused by  $R_{\text{up}}$ , may cause difference in the hysteresis voltage.
- \*4) If the value of  $R_a$ ,  $R_b$  and  $C$  are set excessively large, the delay of the start-up may become too long.

• **Window Comparator Circuit  
(Nch Open Drain Output)**

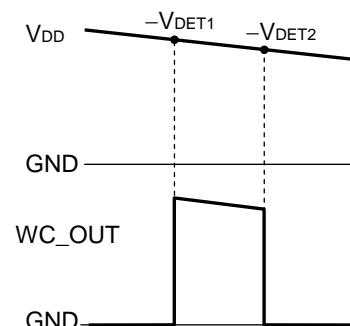

• **Over-charge Preventing Circuit**

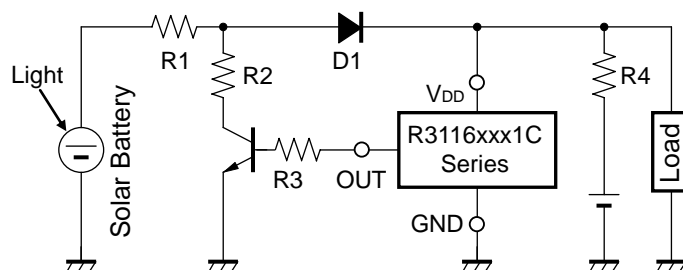

## TECHNICAL NOTES

### When connecting resistors to the device's input pin

When connecting a resistor (R1) to an input of this device, the input voltage decreases by [Device's Consumption Current] x [Resistance Value] only. And, the cross conduction current\*<sup>1</sup>, which occurs when changing from the detecting state to the release state, is decreased the input voltage by [Cross Conduction Current] x [Resistance Value] only. And then, this device will enter the re-detecting state if the input voltage reduction is larger than the difference between the detector voltage and the released voltage.

When the input resistance value is large and the VDD is gone up at mildly in the vicinity of the released voltage, repeating the above operation may result in the occurrence of output.

As shown in Figure A/B, set R1 to become 100kΩ or less as a guide, and connect C<sub>IN</sub> of 0.1μF and more to between the input pin and GND. Besides, make evaluations including temperature properties under the actual usage condition, with using the evaluation board like this way. As result, make sure that the cross conduction current has no problem.



Figure A

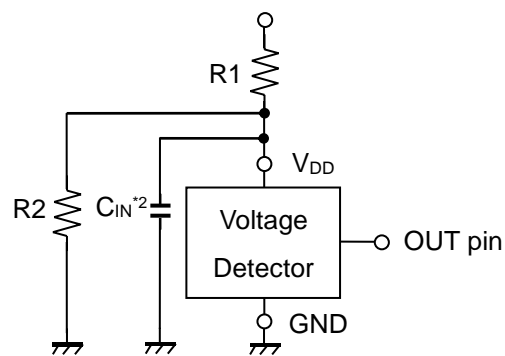

Figure B

\*<sup>1</sup> In the CMOS output type, a charging current for OUT pin is included.

\*<sup>2</sup> Note the bias dependence of capacitors.

## OPERATION

### • Operation of R3116xxx1A

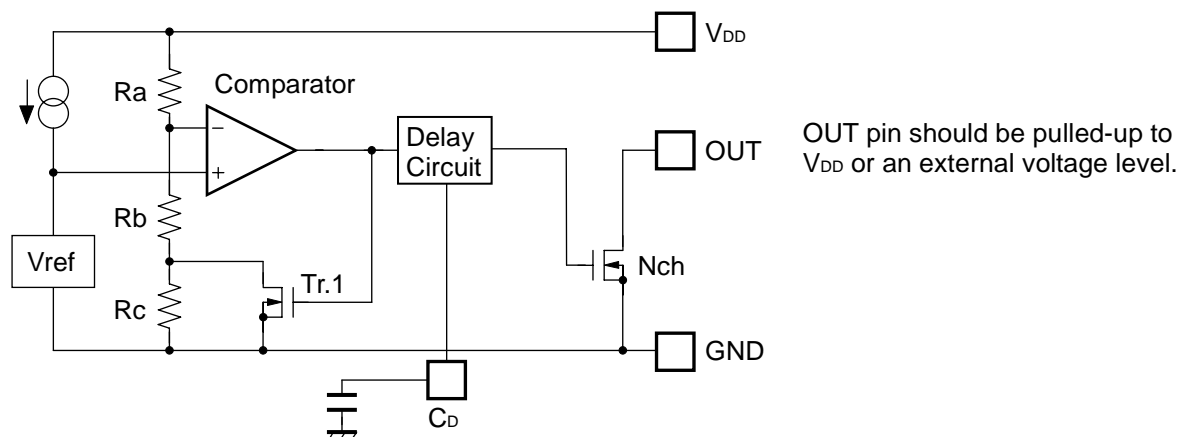

Block Diagram (R3116xxx1A)



| Step                             | 1   | 2  | 3          | 4  | 5   |
|----------------------------------|-----|----|------------|----|-----|
| Comparator (-) Pin Input Voltage | I   | II | II         | II | I   |
| Comparator Output                | L   | H  | Indefinite | H  | L   |
| Tr.1                             | OFF | ON | Indefinite | ON | OFF |
| Output Tr. Nch                   | OFF | ON | Indefinite | ON | OFF |

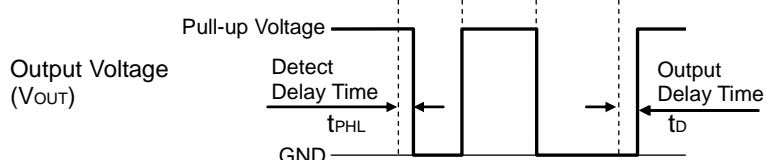

Operation Diagram

$$I \quad \frac{R_b + R_c}{R_a + R_b + R_c} \times V_{DD}$$

$$II \quad \frac{R_b}{R_a + R_b} \times V_{DD}$$

### • Explanation of operation

Step 1. The output voltage is equal to the pull-up voltage.

Step 2. At Point "A",  $V_{ref} \geq V_{DD} \times (R_b + R_c) / (R_a + R_b + R_c)$  is true, as a result, the output of comparator is reversed from "L" to "H", therefore the output voltage becomes the GND level. The voltage level of Point A means a detector threshold voltage ( $-V_{DET}$ ).

Step 3. When the supply voltage is lower than the minimum operating voltage, the operation of the output transistor becomes indefinite. The output voltage is equal to the pull-up voltage.

Step 4. The output voltage is equal to the GND level.

Step 5. At Point "B",  $V_{ref} \leq V_{DD} \times R_b / (R_a + R_b)$  is true, as a result, the output of comparator is reversed from "H" to "L", then the output voltage is equal to the pull-up voltage. The voltage level of Point B means a released voltage ( $+V_{DET}$ ).

\*) The difference between a released voltage and a detector threshold voltage is a detector threshold hysteresis.

• Operation of R3116xxx1C



Block Diagram (R3116xxx1C)

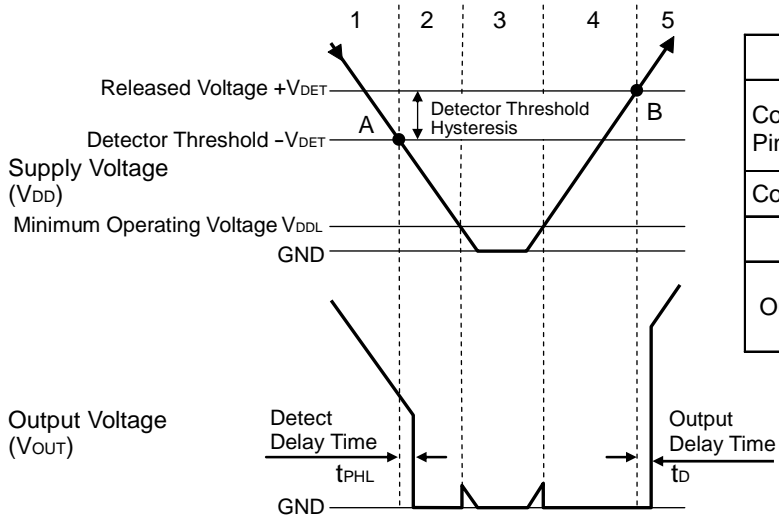

| Step                             | 1   | 2   | 3          | 4          | 5   |     |
|----------------------------------|-----|-----|------------|------------|-----|-----|
| Comparator (-) Pin Input Voltage | I   | II  | II         | II         | I   |     |
| Comparator Output                | L   | H   | Indefinite | H          | L   |     |
| Tr.1                             | OFF | ON  | Indefinite | ON         | OFF |     |
| Output Tr.                       | Pch | ON  | OFF        | Indefinite | OFF | ON  |
|                                  | Nch | OFF | ON         | Indefinite | ON  | OFF |

$$I \quad \frac{Rb+Rc}{Ra+Rb+Rc} \times V_{DD}$$

$$II \quad \frac{Rb}{Ra+Rb} \times V_{DD}$$

Operation Diagram

• Explanation of operation

- Step 1. The output voltage is equal to the supply voltage ( $V_{DD}$ ).
- Step 2. At Point "A",  $V_{ref} \geq V_{DD} \times (Rb+Rc) / (Ra+Rb+Rc)$  is true, as a result, the output of comparator is reversed from "L" to "H", therefore the output voltage becomes the GND level. The voltage level of Point A means a detector threshold voltage ( $-V_{DET}$ ).
- Step 3. When the supply voltage is lower than the minimum operating voltage, the operation of the output transistor becomes indefinite.
- Step 4. The output voltage is equal to the GND level.
- Step 5. At Point "B",  $V_{ref} \leq V_{DD} \times Rb / (Ra+Rb)$  is true, as a result, the output of comparator is reversed from "H" to "L", then the output voltage is equal to the supply voltage ( $V_{DD}$ ). The voltage level of Point B means a released voltage ( $+V_{DET}$ ).

\*) The difference between a released voltage and a detector threshold voltage is a detector threshold hysteresis.

## Detector Operation vs. glitch input voltage to the V<sub>DD</sub> pin

When the R3116x is at released, if the pulse voltage which the detector threshold or lower voltage, the graph below means that the relation between pulse width and the amplitude of the swing to keep the released state for the R3116x.

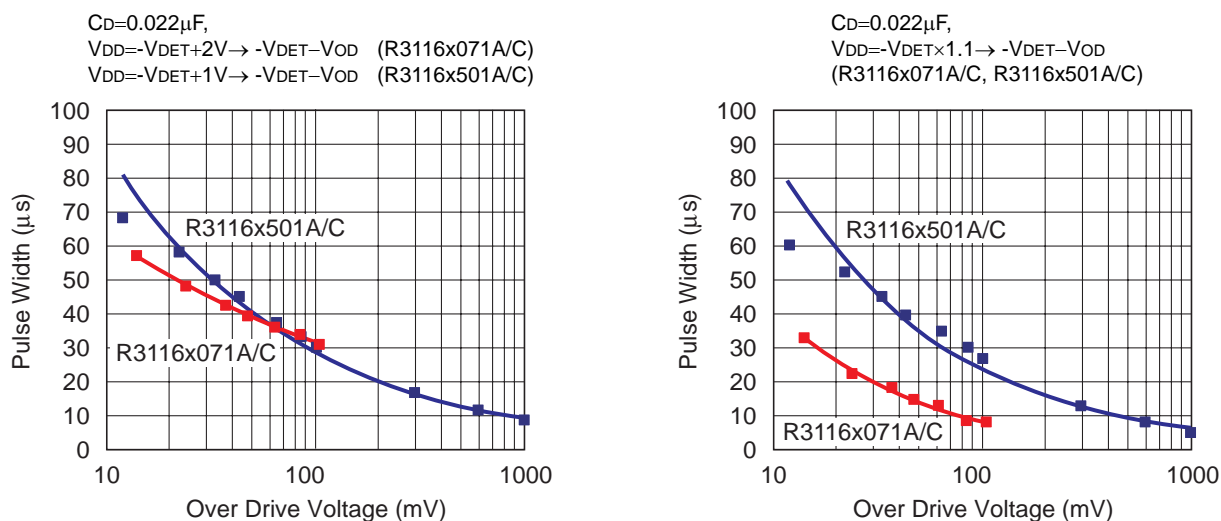

**V<sub>DD</sub> Input Waveform**

This graph shows the maximum pulse conditions to keep the released voltage. If the pulse with larger amplitude or wider width than the graph above, is input to V<sub>DD</sub> pin, the reset signal may be output.

## PACKAGE INFORMATION

### POWER DISSIPATION (DFN(PLP)1010-4)

Power Dissipation ( $P_D$ ) depends on conditions of mounting on board. This specification is based on the measurement at the condition below:

#### Measurement Conditions

|                  |   |
|------------------|---|
|                  | Standard Test Land Pattern                    |
| Environment      | Mounting on Board (Wind velocity=0m/s)        |
| Board Material   | Glass cloth epoxy plastic (Double sided)      |
| Board Dimensions | 40mm*40mm*1.6mm                               |
| Copper Ratio     | Top side: Approx. 50%, Back side: Approx. 50% |
| Through-holes    | $\phi$ 0.54mm * 24pcs                         |

#### Measurement Result:

( $T_a=25^\circ\text{C}$ ,  $T_{j\text{max}}=125^\circ\text{C}$ )

|                    |  |
|--------------------|--|
|                    | Standard Test Land Pattern   |
| Power Dissipation  | 400mW  |
| Thermal Resistance | $\theta_{ja} = (125-25^\circ\text{C})/0.4\text{W} = 250^\circ\text{C/W}$ |
|                    | $\theta_{jc} = 67^\circ\text{C/W}$                                       |

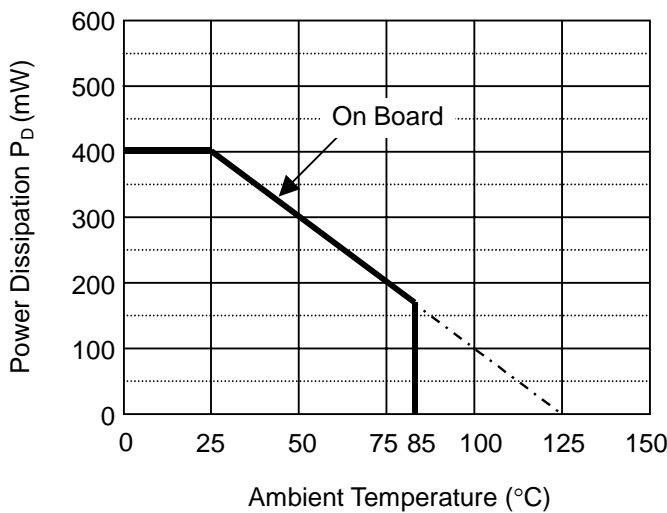

**Power Dissipation**



**Measurement Board Pattern**

 IC Mount Area (Unit : mm)





**R3116x**

NO.EA-161-140819

**MARK SPECIFICATION TABLE (DFN(PLP)1010-4)****R3116Kxx1A**

| Product Name | ①② | V <sub>SET</sub> |
|--------------|----|------------------|
| R3116K071A   | HA | 0.7V             |
| R3116K081A   | HB | 0.8V             |
| R3116K091A   | HC | 0.9V             |
| R3116K101A   | HD | 1.0V             |
| R3116K111A   | HE | 1.1V             |
| R3116K121A   | HF | 1.2V             |
| R3116K131A   | HG | 1.3V             |
| R3116K141A   | HH | 1.4V             |
| R3116K151A   | HJ | 1.5V             |
| R3116K161A   | HK | 1.6V             |
| R3116K171A   | HL | 1.7V             |
| R3116K181A   | HM | 1.8V             |
| R3116K191A   | HN | 1.9V             |
| R3116K201A   | HP | 2.0V             |
| R3116K211A   | HQ | 2.1V             |
| R3116K221A   | HR | 2.2V             |
| R3116K231A   | HS | 2.3V             |
| R3116K241A   | HT | 2.4V             |
| R3116K251A   | HU | 2.5V             |
| R3116K261A   | HV | 2.6V             |
| R3116K271A   | HW | 2.7V             |
| R3116K281A   | HX | 2.8V             |
| R3116K291A   | HY | 2.9V             |
| R3116K301A   | HZ | 3.0V             |
| R3116K311A   | JA | 3.1V             |
| R3116K321A   | JB | 3.2V             |
| R3116K331A   | JC | 3.3V             |
| R3116K341A   | JD | 3.4V             |
| R3116K351A   | JE | 3.5V             |
| R3116K361A   | JF | 3.6V             |
| R3116K371A   | JG | 3.7V             |
| R3116K381A   | JH | 3.8V             |
| R3116K391A   | JJ | 3.9V             |
| R3116K401A   | JK | 4.0V             |
| R3116K411A   | JL | 4.1V             |
| R3116K421A   | JM | 4.2V             |
| R3116K431A   | JN | 4.3V             |
| R3116K441A   | JP | 4.4V             |
| R3116K451A   | JQ | 4.5V             |
| R3116K461A   | JR | 4.6V             |
| R3116K471A   | JS | 4.7V             |
| R3116K481A   | JT | 4.8V             |
| R3116K491A   | JU | 4.9V             |
| R3116K501A   | JV | 5.0V             |

**R3116Kxx1C**

| Product Name | ①② | V <sub>SET</sub> |
|--------------|----|------------------|
| R3116K071C   | KA | 0.7V             |
| R3116K081C   | KB | 0.8V             |
| R3116K091C   | KC | 0.9V             |
| R3116K101C   | KD | 1.0V             |
| R3116K111C   | KE | 1.1V             |
| R3116K121C   | KF | 1.2V             |
| R3116K131C   | KG | 1.3V             |
| R3116K141C   | KH | 1.4V             |
| R3116K151C   | KJ | 1.5V             |
| R3116K161C   | KK | 1.6V             |
| R3116K171C   | KL | 1.7V             |
| R3116K181C   | KM | 1.8V             |
| R3116K191C   | KN | 1.9V             |
| R3116K201C   | KP | 2.0V             |
| R3116K211C   | KQ | 2.1V             |
| R3116K221C   | KR | 2.2V             |
| R3116K231C   | KS | 2.3V             |
| R3116K241C   | KT | 2.4V             |
| R3116K251C   | KU | 2.5V             |
| R3116K261C   | KV | 2.6V             |
| R3116K271C   | KW | 2.7V             |
| R3116K281C   | KX | 2.8V             |
| R3116K291C   | KY | 2.9V             |
| R3116K301C   | KZ | 3.0V             |
| R3116K311C   | LA | 3.1V             |
| R3116K321C   | LB | 3.2V             |
| R3116K331C   | LC | 3.3V             |
| R3116K341C   | LD | 3.4V             |
| R3116K351C   | LE | 3.5V             |
| R3116K361C   | LF | 3.6V             |
| R3116K371C   | LG | 3.7V             |
| R3116K381C   | LH | 3.8V             |
| R3116K391C   | LJ | 3.9V             |
| R3116K401C   | LK | 4.0V             |
| R3116K411C   | LL | 4.1V             |
| R3116K421C   | LM | 4.2V             |
| R3116K431C   | LN | 4.3V             |
| R3116K441C   | LP | 4.4V             |
| R3116K451C   | LQ | 4.5V             |
| R3116K461C   | LR | 4.6V             |
| R3116K471C   | LS | 4.7V             |
| R3116K481C   | LT | 4.8V             |
| R3116K491C   | LU | 4.9V             |
| R3116K501C   | LV | 5.0V             |

**POWER DISSIPATION (SC-82AB)**

Power Dissipation ( $P_D$ ) depends on conditions of mounting on board. This specification is based on the measurement at the condition below;

## \* Measurement Conditions

|                  | <b>Standard Land Pattern</b>                  |
|------------------|---|
| Environment      | Mounting on Board (Wind velocity=0m/s)        |
| Board Material   | Glass cloth epoxy plastic (Double Layers)     |
| Board Dimensions | 40mm × 40mm × 1.6mm                           |
| Copper Ratio     | Top side: Approx. 50%, Back side: Approx. 50% |
| Through-hole     | φ0.5mm × 44pcs                                |

## \* Measurement Result

(Ta=25°C, Tjmax=125°C)

|                    | <b>Standard Land Pattern</b>  | <b>Free Air</b> |
|--------------------|---|-----------------|
| Power Dissipation  | 380mW   | 150mW           |
| Thermal Resistance | $\theta_{ja} = (125-25^\circ\text{C})/0.38\text{W} = 263^\circ\text{C/W}$ | 667°C/W         |

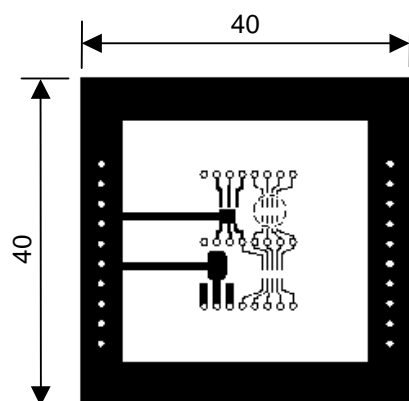
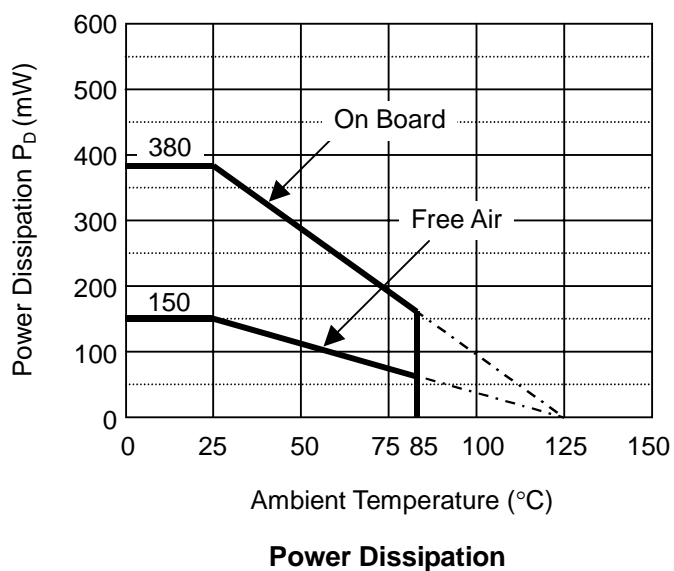
**Measurement Board Pattern**

○ IC Mount Area (Unit : mm)

---

**R3116x**NO.EA-161-140819

---

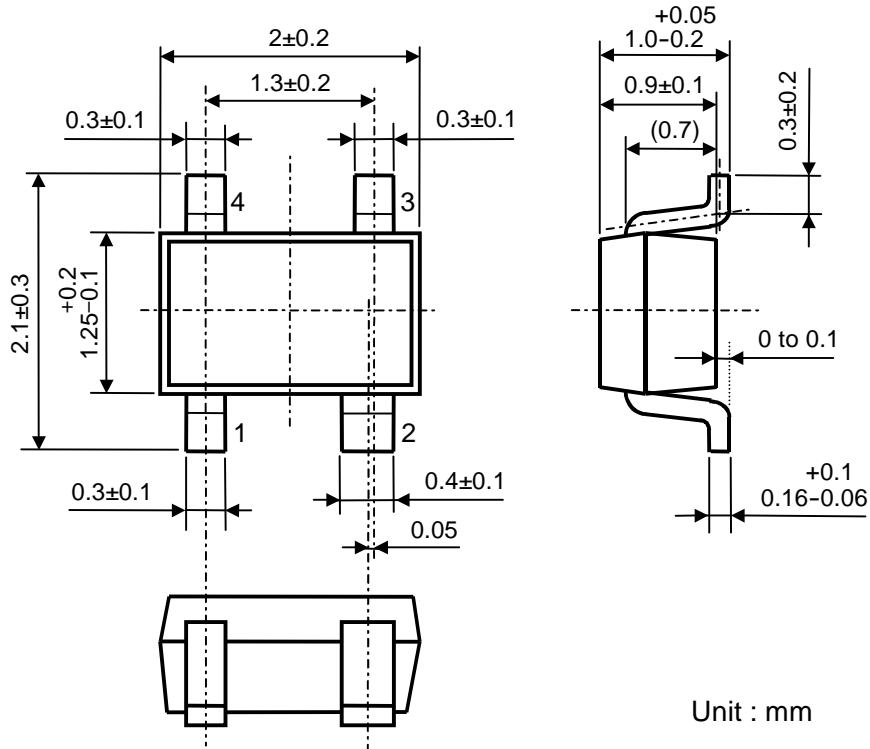
**PACKAGE DIMENSIONS (SC-82AB)****MARK SPECIFICATION (SC-82AB)**①②: Product Code ... Refer to MARK SPECIFICATION TABLE

③④: Lot Number ... Alphanumeric Serial Number

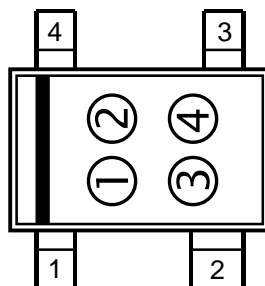

## MARK SPECIFICATION TABLE (SC-82AB)

R3116Qxx1A

| Product Name | ① ② | V <sub>SET</sub> |
|--------------|-----|------------------|
| R3116Q071A   | L 0 | 0.7V             |
| R3116Q081A   | L 1 | 0.8V             |
| R3116Q091A   | L 2 | 0.9V             |
| R3116Q101A   | L 3 | 1.0V             |
| R3116Q111A   | L 4 | 1.1V             |
| R3116Q121A   | L 5 | 1.2V             |
| R3116Q131A   | L 6 | 1.3V             |
| R3116Q141A   | L 7 | 1.4V             |
| R3116Q151A   | L 8 | 1.5V             |
| R3116Q161A   | L 9 | 1.6V             |
| R3116Q171A   | M 0 | 1.7V             |
| R3116Q181A   | M 1 | 1.8V             |
| R3116Q191A   | M 2 | 1.9V             |
| R3116Q201A   | M 3 | 2.0V             |
| R3116Q211A   | M 4 | 2.1V             |
| R3116Q221A   | M 5 | 2.2V             |
| R3116Q231A   | M 6 | 2.3V             |
| R3116Q241A   | M 7 | 2.4V             |
| R3116Q251A   | M 8 | 2.5V             |
| R3116Q261A   | M 9 | 2.6V             |
| R3116Q271A   | N 0 | 2.7V             |
| R3116Q281A   | N 1 | 2.8V             |
| R3116Q291A   | N 2 | 2.9V             |
| R3116Q301A   | N 3 | 3.0V             |
| R3116Q311A   | N 4 | 3.1V             |
| R3116Q321A   | N 5 | 3.2V             |
| R3116Q331A   | N 6 | 3.3V             |
| R3116Q341A   | N 7 | 3.4V             |
| R3116Q351A   | N 8 | 3.5V             |
| R3116Q361A   | N 9 | 3.6V             |
| R3116Q371A   | P 0 | 3.7V             |
| R3116Q381A   | P 1 | 3.8V             |
| R3116Q391A   | P 2 | 3.9V             |
| R3116Q401A   | P 3 | 4.0V             |
| R3116Q411A   | P 4 | 4.1V             |
| R3116Q421A   | P 5 | 4.2V             |
| R3116Q431A   | P 6 | 4.3V             |
| R3116Q441A   | P 7 | 4.4V             |
| R3116Q451A   | P 8 | 4.5V             |
| R3116Q461A   | P 9 | 4.6V             |
| R3116Q471A   | Q 0 | 4.7V             |
| R3116Q481A   | Q 1 | 4.8V             |
| R3116Q491A   | Q 2 | 4.9V             |
| R3116Q501A   | Q 3 | 5.0V             |

R3116Qxx1C

| Product Name | ① ② | V <sub>SET</sub> |
|--------------|-----|------------------|
| R3116Q071C   | R 0 | 0.7V             |
| R3116Q081C   | R 1 | 0.8V             |
| R3116Q091C   | R 2 | 0.9V             |
| R3116Q101C   | R 3 | 1.0V             |
| R3116Q111C   | R 4 | 1.1V             |
| R3116Q121C   | R 5 | 1.2V             |
| R3116Q131C   | R 6 | 1.3V             |
| R3116Q141C   | R 7 | 1.4V             |
| R3116Q151C   | R 8 | 1.5V             |
| R3116Q161C   | R 9 | 1.6V             |
| R3116Q171C   | S 0 | 1.7V             |
| R3116Q181C   | S 1 | 1.8V             |
| R3116Q191C   | S 2 | 1.9V             |
| R3116Q201C   | S 3 | 2.0V             |
| R3116Q211C   | S 4 | 2.1V             |
| R3116Q221C   | S 5 | 2.2V             |
| R3116Q231C   | S 6 | 2.3V             |
| R3116Q241C   | S 7 | 2.4V             |
| R3116Q251C   | S 8 | 2.5V             |
| R3116Q261C   | S 9 | 2.6V             |
| R3116Q271C   | T 0 | 2.7V             |
| R3116Q281C   | T 1 | 2.8V             |
| R3116Q291C   | T 2 | 2.9V             |
| R3116Q301C   | T 3 | 3.0V             |
| R3116Q311C   | T 4 | 3.1V             |
| R3116Q321C   | T 5 | 3.2V             |
| R3116Q331C   | T 6 | 3.3V             |
| R3116Q341C   | T 7 | 3.4V             |
| R3116Q351C   | T 8 | 3.5V             |
| R3116Q361C   | T 9 | 3.6V             |
| R3116Q371C   | U 0 | 3.7V             |
| R3116Q381C   | U 1 | 3.8V             |
| R3116Q391C   | U 2 | 3.9V             |
| R3116Q401C   | U 3 | 4.0V             |
| R3116Q411C   | U 4 | 4.1V             |
| R3116Q421C   | U 5 | 4.2V             |
| R3116Q431C   | U 6 | 4.3V             |
| R3116Q441C   | U 7 | 4.4V             |
| R3116Q451C   | U 8 | 4.5V             |
| R3116Q461C   | U 9 | 4.6V             |
| R3116Q471C   | V 0 | 4.7V             |
| R3116Q481C   | V 1 | 4.8V             |
| R3116Q491C   | V 2 | 4.9V             |
| R3116Q501C   | V 3 | 5.0V             |

**R3116x**

NO.EA-161-140819

**POWER DISSIPATION (SOT-23-5)**

Power Dissipation ( $P_D$ ) depends on conditions of mounting on board. This specification is based on the measurement at the condition below:

(Power Dissipation (SOT-23-5) is substitution of SOT-23-6.)

\* Measurement Conditions

|                  |   |
|------------------|---|
|                  | Standard Test Land Pattern                    |
| Environment      | Mounting on Board (Wind velocity=0m/s)        |
| Board Material   | Glass cloth epoxy plastic (Double sided)      |
| Board Dimensions | 40mm*40mm*1.6mm                               |
| Copper Ratio     | Top side: Approx. 50%, Back side: Approx. 50% |
| Through-holes    | $\phi$ 0.5mm * 44pcs                          |

\* Measurement Result: ..... (Ta=25°C, Tjmax=125°C)

|                    |   |          |
|--------------------|---|----------|
|                    | Standard Land Pattern   | Free Air |
| Power Dissipation  | 420mW   | 250mW    |
| Thermal Resistance | $\theta_{ja} = (125-25^\circ\text{C})/0.42\text{W} = 238^\circ\text{C/W}$ | 400°C/W  |



**Power Dissipation**

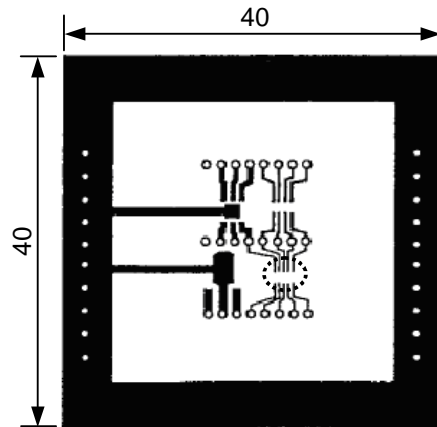

**Measurement Board Pattern**

○ IC Mount Area (Unit: mm)

## PACKAGE DIMENSIONS (SOT-23-5)



## MARK SPECIFICATION (SOT-23-5)

①②③: Product Code ... **Refer to MARK SPECIFICATION TABLE**

④⑤: Lot Number ... Alphanumeric Serial Number



**R3116x**

NO.EA-161-140819

**MARK SPECIFICATION TABLE (SOT-23-5)****R3116Nxx1A**

| Product Name | ①②③   | V <sub>SET</sub> |
|--------------|-------|------------------|
| R3116N071A   | D 0 A | 0.7V             |
| R3116N081A   | D 0 B | 0.8V             |
| R3116N091A   | D 0 C | 0.9V             |
| R3116N101A   | D 0 D | 1.0V             |
| R3116N111A   | D 0 E | 1.1V             |
| R3116N121A   | D 0 F | 1.2V             |
| R3116N131A   | D 0 G | 1.3V             |
| R3116N141A   | D 0 H | 1.4V             |
| R3116N151A   | D 0 J | 1.5V             |
| R3116N161A   | D 0 K | 1.6V             |
| R3116N171A   | D 0 L | 1.7V             |
| R3116N181A   | D 0 M | 1.8V             |
| R3116N191A   | D 0 N | 1.9V             |
| R3116N201A   | D 0 P | 2.0V             |
| R3116N211A   | D 0 Q | 2.1V             |
| R3116N221A   | D 0 R | 2.2V             |
| R3116N231A   | D 0 S | 2.3V             |
| R3116N241A   | D 0 T | 2.4V             |
| R3116N251A   | D 0 U | 2.5V             |
| R3116N261A   | D 0 V | 2.6V             |
| R3116N271A   | D 0 W | 2.7V             |
| R3116N281A   | D 0 X | 2.8V             |
| R3116N291A   | D 0 Y | 2.9V             |
| R3116N301A   | D 0 Z | 3.0V             |
| R3116N311A   | E 0 A | 3.1V             |
| R3116N321A   | E 0 B | 3.2V             |
| R3116N331A   | E 0 C | 3.3V             |
| R3116N341A   | E 0 D | 3.4V             |
| R3116N351A   | E 0 E | 3.5V             |
| R3116N361A   | E 0 F | 3.6V             |
| R3116N371A   | E 0 G | 3.7V             |
| R3116N381A   | E 0 H | 3.8V             |
| R3116N391A   | E 0 J | 3.9V             |
| R3116N401A   | E 0 K | 4.0V             |
| R3116N411A   | E 0 L | 4.1V             |
| R3116N421A   | E 0 M | 4.2V             |
| R3116N431A   | E 0 N | 4.3V             |
| R3116N441A   | E 0 P | 4.4V             |
| R3116N451A   | E 0 Q | 4.5V             |
| R3116N461A   | E 0 R | 4.6V             |
| R3116N471A   | E 0 S | 4.7V             |
| R3116N481A   | E 0 T | 4.8V             |
| R3116N491A   | E 0 U | 4.9V             |
| R3116N501A   | E 0 V | 5.0V             |

**R3116Nxx1C**

| Product Name | ①②③   | V <sub>SET</sub> |
|--------------|-------|------------------|
| R3116N071C   | D 1 A | 0.7V             |
| R3116N081C   | D 1 B | 0.8V             |
| R3116N091C   | D 1 C | 0.9V             |
| R3116N101C   | D 1 D | 1.0V             |
| R3116N111C   | D 1 E | 1.1V             |
| R3116N121C   | D 1 F | 1.2V             |
| R3116N131C   | D 1 G | 1.3V             |
| R3116N141C   | D 1 H | 1.4V             |
| R3116N151C   | D 1 J | 1.5V             |
| R3116N161C   | D 1 K | 1.6V             |
| R3116N171C   | D 1 L | 1.7V             |
| R3116N181C   | D 1 M | 1.8V             |
| R3116N191C   | D 1 N | 1.9V             |
| R3116N201C   | D 1 P | 2.0V             |
| R3116N211C   | D 1 Q | 2.1V             |
| R3116N221C   | D 1 R | 2.2V             |
| R3116N231C   | D 1 S | 2.3V             |
| R3116N241C   | D 1 T | 2.4V             |
| R3116N251C   | D 1 U | 2.5V             |
| R3116N261C   | D 1 V | 2.6V             |
| R3116N271C   | D 1 W | 2.7V             |
| R3116N281C   | D 1 X | 2.8V             |
| R3116N291C   | D 1 Y | 2.9V             |
| R3116N301C   | D 1 Z | 3.0V             |
| R3116N311C   | E 1 A | 3.1V             |
| R3116N321C   | E 1 B | 3.2V             |
| R3116N331C   | E 1 C | 3.3V             |
| R3116N341C   | E 1 D | 3.4V             |
| R3116N351C   | E 1 E | 3.5V             |
| R3116N361C   | E 1 F | 3.6V             |
| R3116N371C   | E 1 G | 3.7V             |
| R3116N381C   | E 1 H | 3.8V             |
| R3116N391C   | E 1 J | 3.9V             |
| R3116N401C   | E 1 K | 4.0V             |
| R3116N411C   | E 1 L | 4.1V             |
| R3116N421C   | E 1 M | 4.2V             |
| R3116N431C   | E 1 N | 4.3V             |
| R3116N441C   | E 1 P | 4.4V             |
| R3116N451C   | E 1 Q | 4.5V             |
| R3116N461C   | E 1 R | 4.6V             |
| R3116N471C   | E 1 S | 4.7V             |
| R3116N481C   | E 1 T | 4.8V             |
| R3116N491C   | E 1 U | 4.9V             |
| R3116N501C   | E 1 V | 5.0V             |



## TYPICAL CHARACTERISTICS

Note: Typical Characteristics are intended to be used as reference data; they are not guaranteed.

### 1) Supply Current vs. Input Voltage

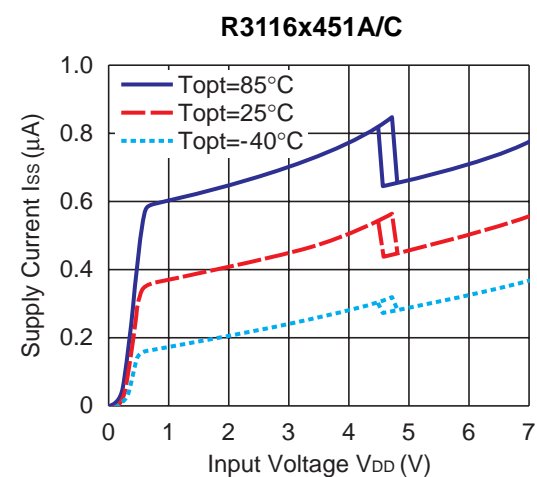
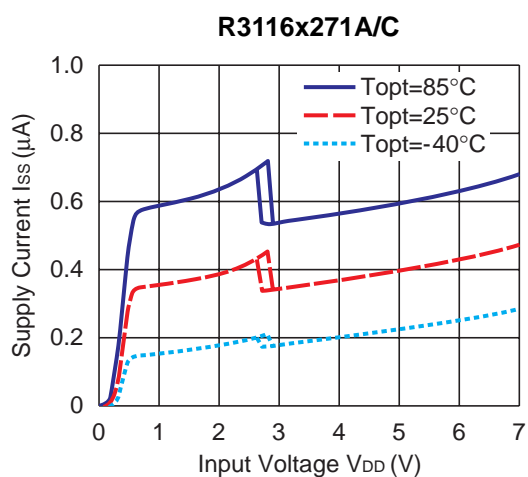
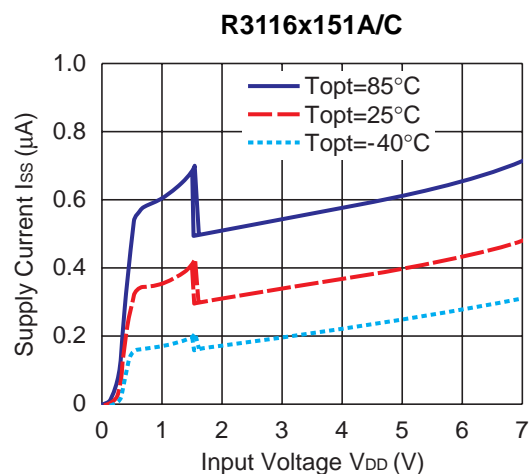
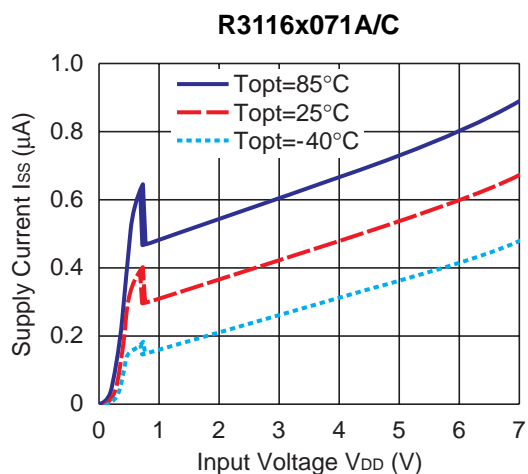

### 2) Detector Threshold vs. Temperature

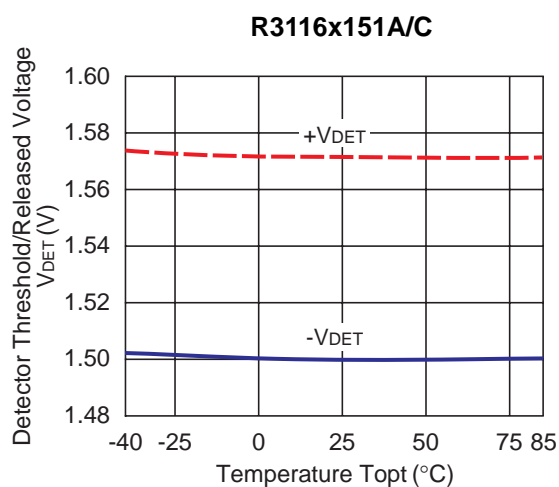
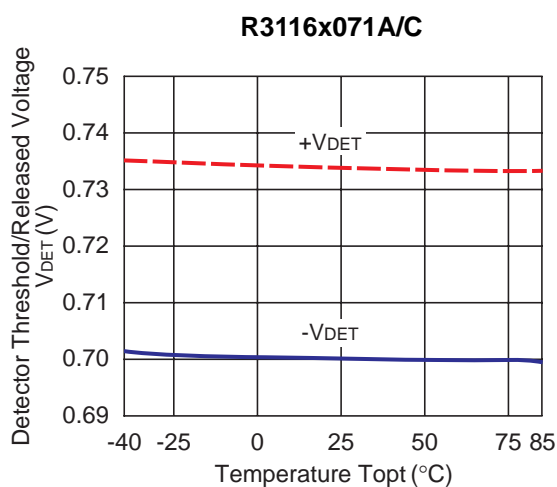

# R3116x

NO.EA-161-140819

### R3116x271A/C

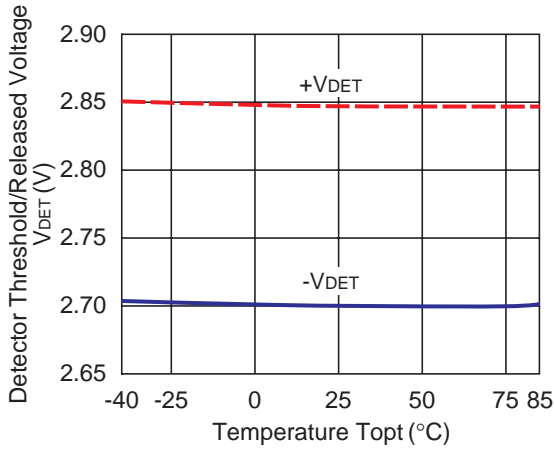

### R3116x451A/C

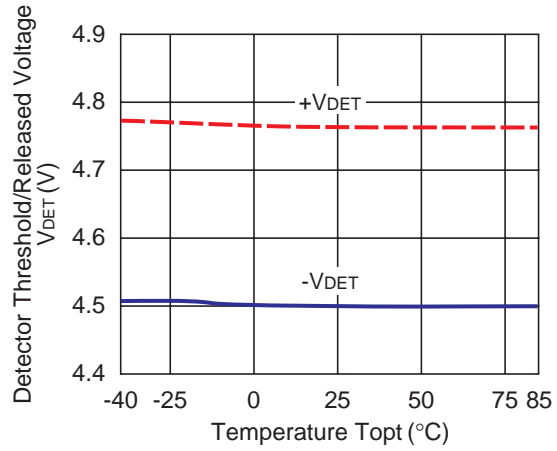

## 3) Output Voltage vs. Input Voltage

### R3116x071C

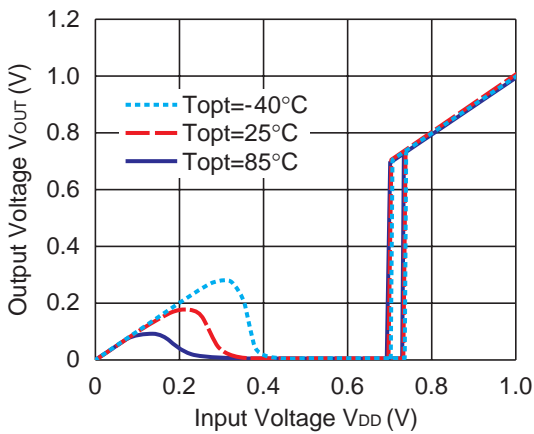

### R3116x151C

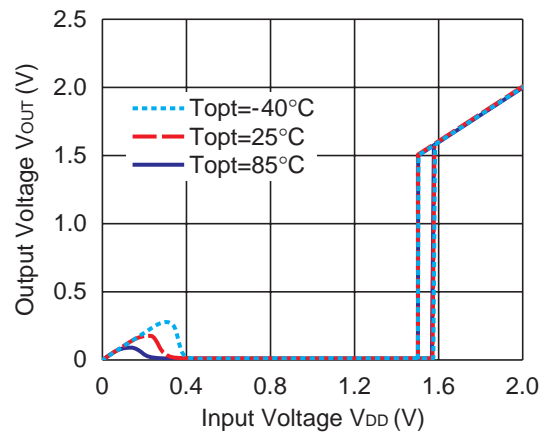

### R3116x271C

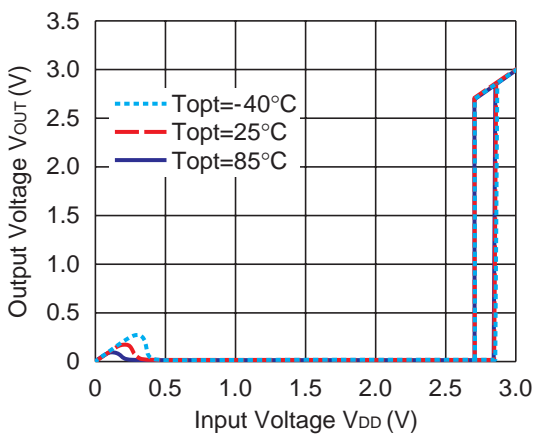

### R3116x451C

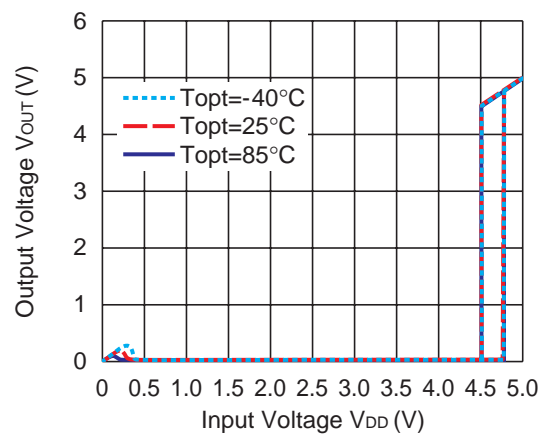

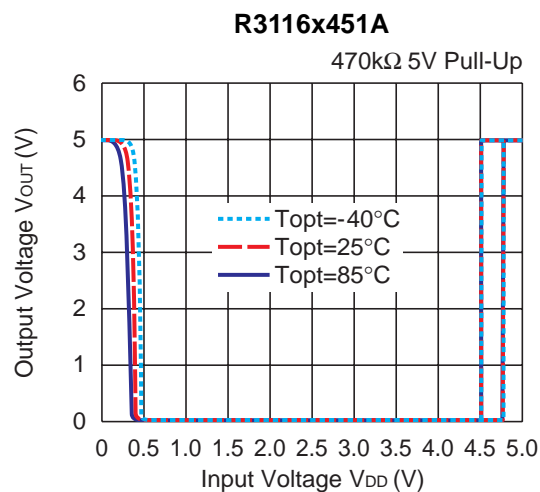
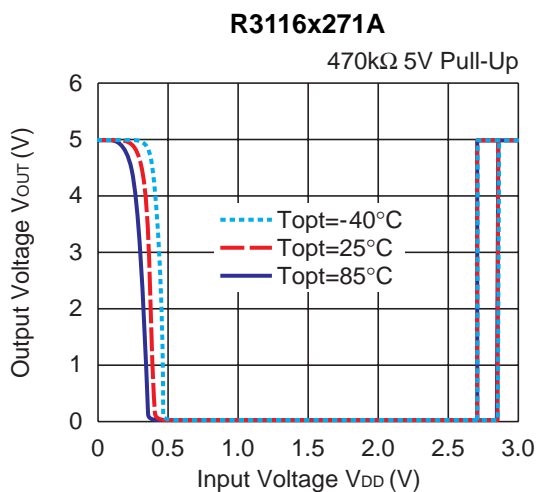
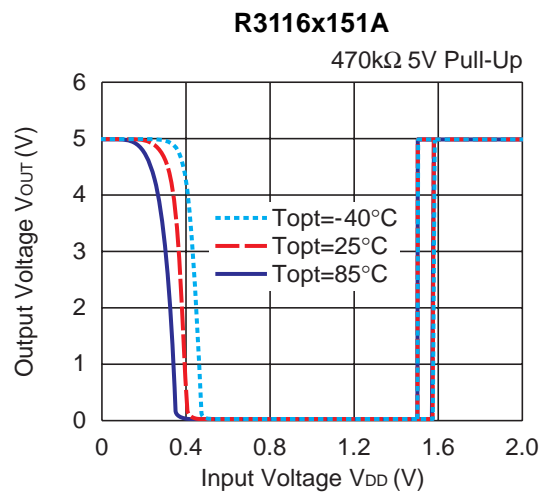
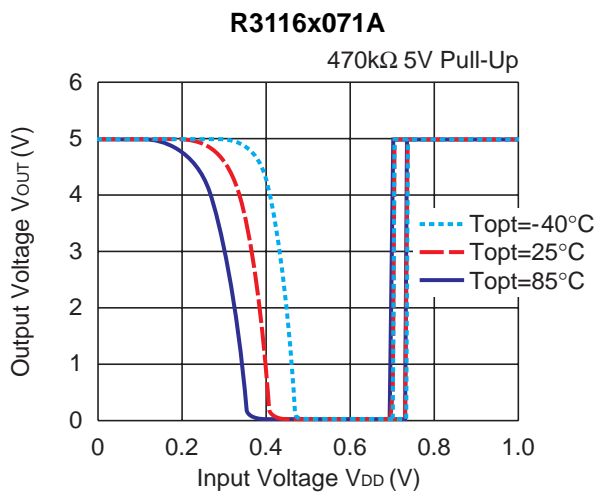

4) Nch Driver Output Current vs. Input Voltage ( $V_{ds}=0.5V$ )

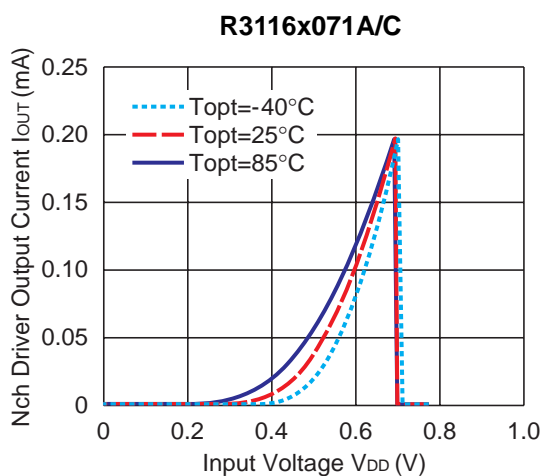

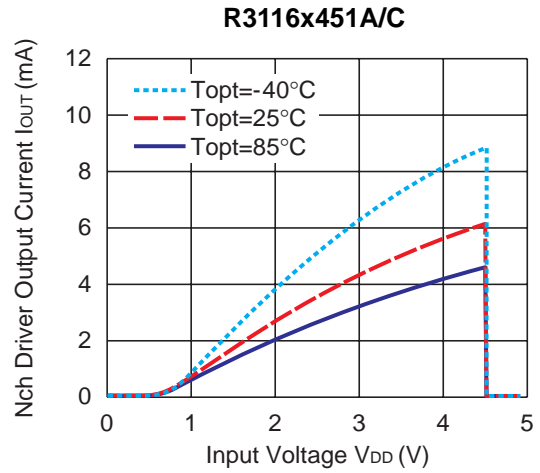
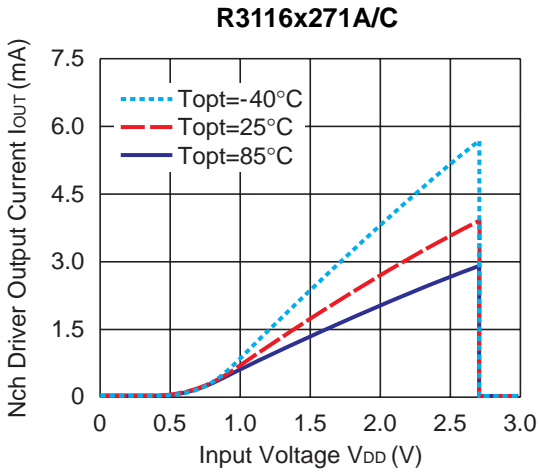

**5) Nch Driver Output Current vs.  $V_{DS}$**

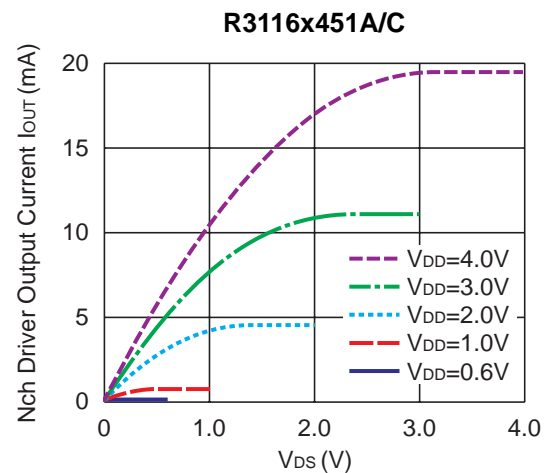
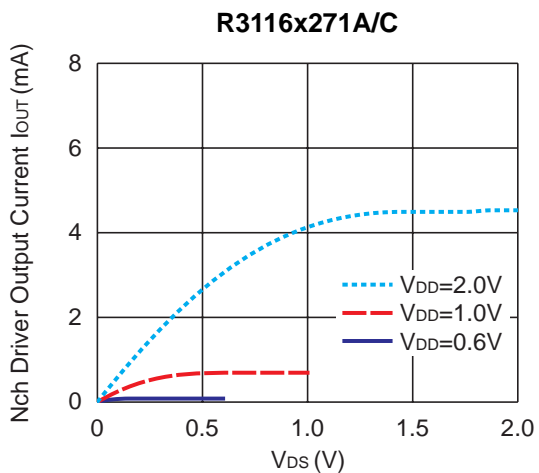
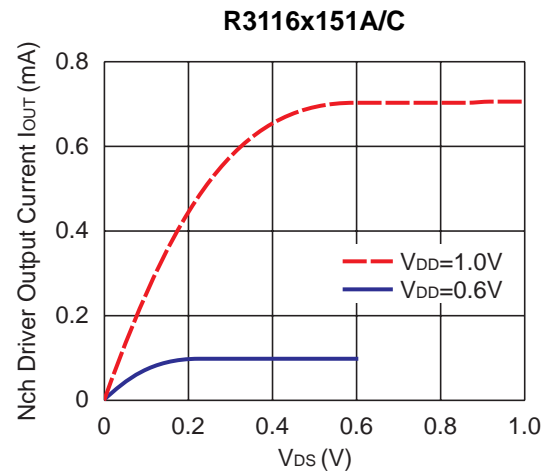
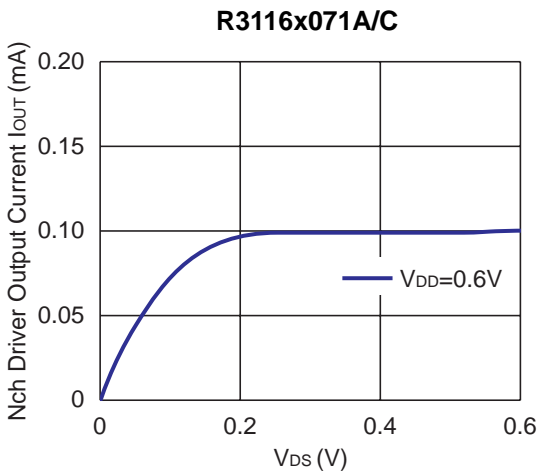

6) Pch Driver Output Current vs. Input Voltage ( $V_{DS}=-2.1V$ )

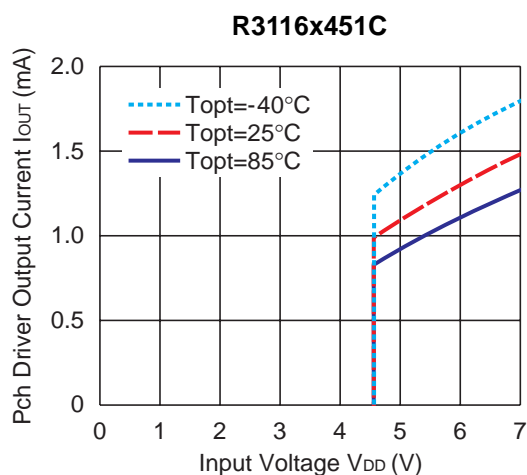
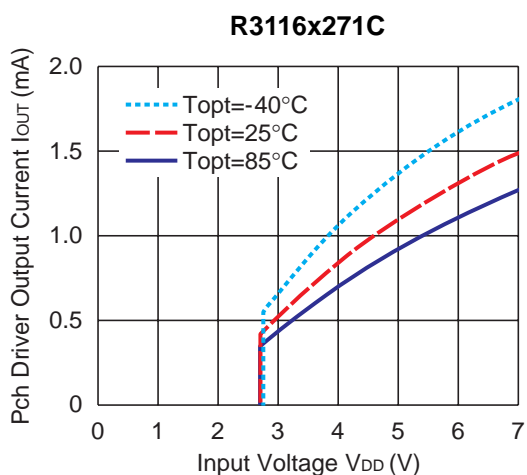
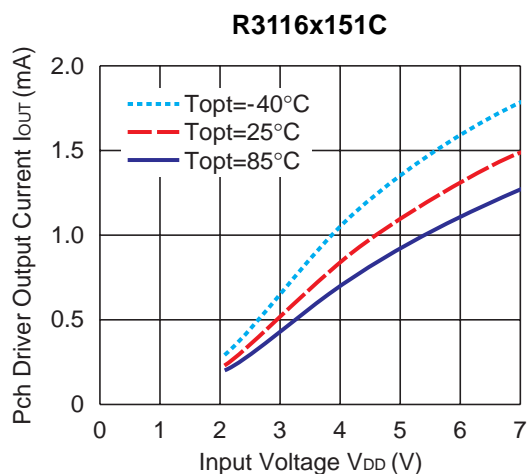
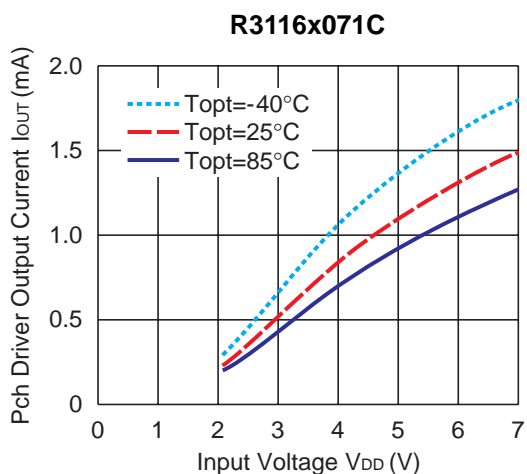

7) Pch Driver Output Current vs.  $V_{DS}$

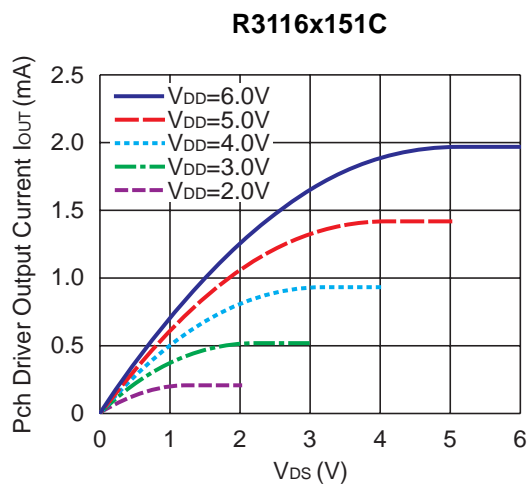
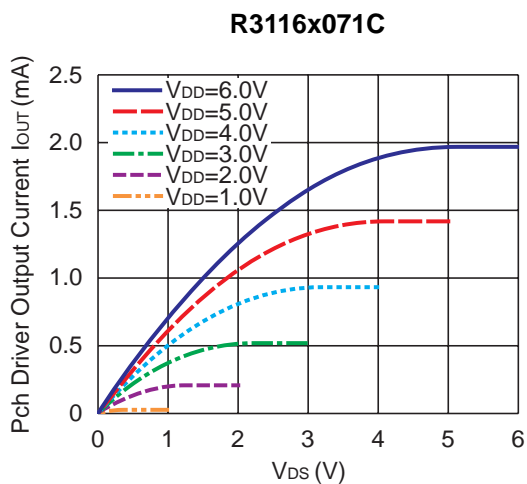

# R3116x

NO.EA-161-140819

### R3116x271C

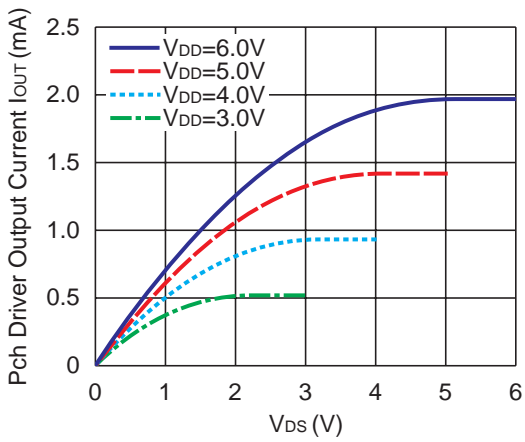

### R3116x451C



## 8) Output Delay Time vs. External Capacitance

### R3116x071A/C



### R3116x151A/C

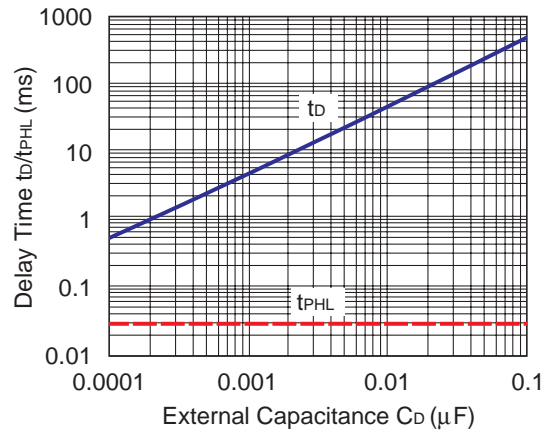

### R3116x271A/C

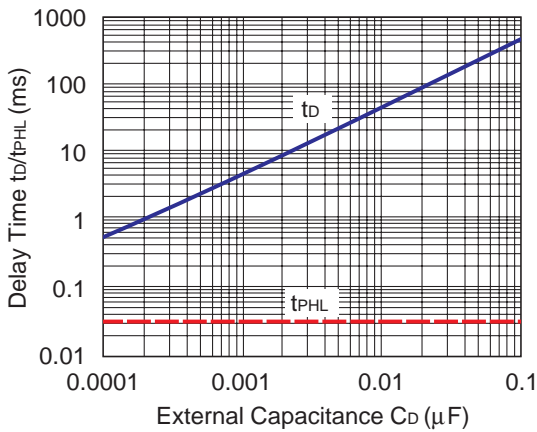

### R3116x451A/C

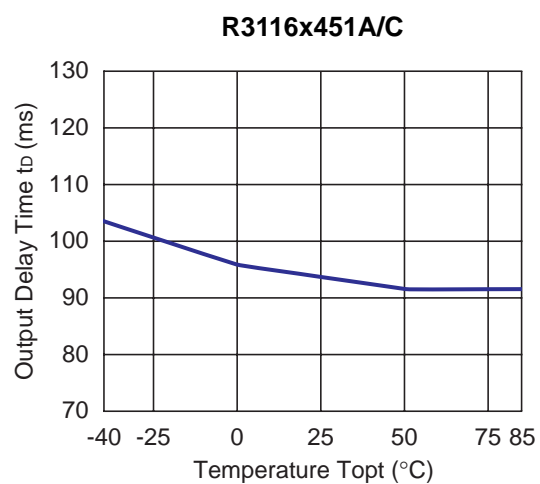
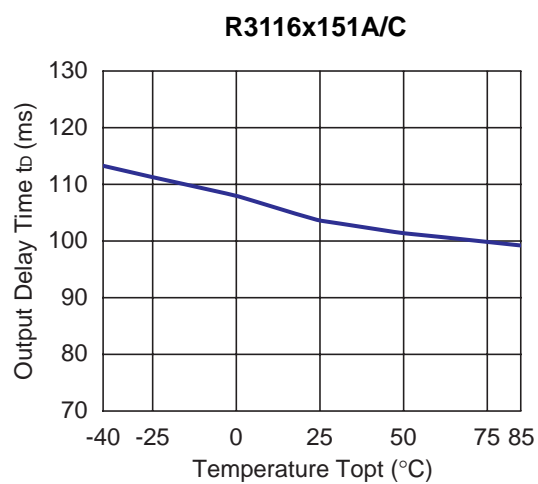
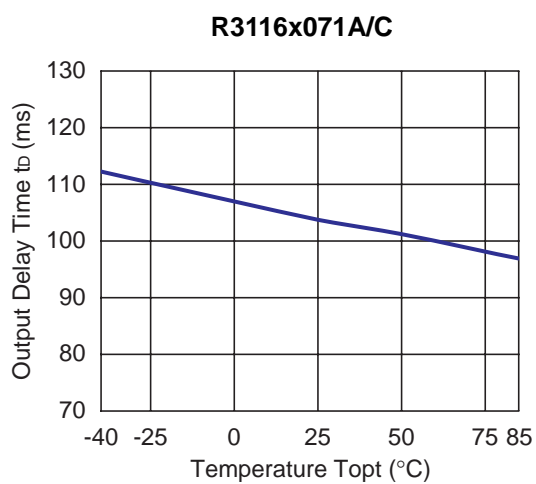

**9) Output Delay Time vs. Temperature ( $C_D=22nF$ )**



1. The products and the product specifications described in this document are subject to change or discontinuation of production without notice for reasons such as improvement. Therefore, before deciding to use the products, please refer to Ricoh sales representatives for the latest information thereon.
2. The materials in this document may not be copied or otherwise reproduced in whole or in part without prior written consent of Ricoh.
3. Please be sure to take any necessary formalities under relevant laws or regulations before exporting or otherwise taking out of your country the products or the technical information described herein.
4. The technical information described in this document shows typical characteristics of and example application circuits for the products. The release of such information is not to be construed as a warranty of or a grant of license under Ricoh's or any third party's intellectual property rights or any other rights.
5. The products listed in this document are intended and designed for use as general electronic components in standard applications (office equipment, telecommunication equipment, measuring instruments, consumer electronic products, amusement equipment etc.). Those customers intending to use a product in an application requiring extreme quality and reliability, for example, in a highly specific application where the failure or misoperation of the product could result in human injury or death (aircraft, spacevehicle, nuclear reactor control system, traffic control system, automotive and transportation equipment, combustion equipment, safety devices, life support system etc.) should first contact us.
6. We are making our continuous effort to improve the quality and reliability of our products, but semiconductor products are likely to fail with certain probability. In order to prevent any injury to persons or damages to property resulting from such failure, customers should be careful enough to incorporate safety measures in their design, such as redundancy feature, fire containment feature and fail-safe feature. We do not assume any liability or responsibility for any loss or damage arising from misuse or inappropriate use of the products.
7. Anti-radiation design is not implemented in the products described in this document.
8. The X-ray exposure can influence functions and characteristics of the products. Confirm the product functions and characteristics in the evaluation stage.
9. WLCSP products should be used in light shielded environments. The light exposure can influence functions and characteristics of the products under operation or storage.
10. There can be variation in the marking when different AOI (Automated Optical Inspection) equipment is used. In the case of recognizing the marking characteristic with AOI, please contact Ricoh sales or our distributor before attempting to use AOI.
11. Please contact Ricoh sales representatives should you have any questions or comments concerning the products or the technical information.



**Ricoh is committed to reducing the environmental loading materials in electrical devices with a view to contributing to the protection of human health and the environment.**

Ricoh has been providing RoHS compliant products since April 1, 2006 and Halogen-free products since April 1, 2012.

**RICOH** RICOH ELECTRONIC DEVICES CO., LTD.

<https://www.e-devices.ricoh.co.jp/en/>

#### Sales & Support Offices

##### **Ricoh Electronic Devices Co., Ltd.**

##### **Shin-Yokohama Office (International Sales)**

2-3, Shin-Yokohama 3-chome, Kohoku-ku, Yokohama-shi, Kanagawa, 222-8530, Japan  
Phone: +81-50-3814-7687 Fax: +81-45-474-0074

##### **Ricoh Americas Holdings, Inc.**

675 Campbell Technology Parkway, Suite 200 Campbell, CA 95008, U.S.A.  
Phone: +1-408-610-3105

##### **Ricoh Europe (Netherlands) B.V.**

##### **Semiconductor Support Centre**

Prof. W.H. Keesomlaan 1, 1183 DJ Amstelveen, The Netherlands  
Phone: +31-20-5474-309

##### **Ricoh International B.V. - German Branch**

##### **Semiconductor Sales and Support Centre**

Oberrather Strasse 6, 40472 Düsseldorf, Germany  
Phone: +49-211-6546-0

##### **Ricoh Electronic Devices Korea Co., Ltd.**

3F, Haesung Bldg, 504, Teheran-ro, Gangnam-gu, Seoul, 135-725, Korea  
Phone: +82-2-2135-5700 Fax: +82-2-2051-5713

##### **Ricoh Electronic Devices Shanghai Co., Ltd.**

Room 403, No.2 Building, No.690 Bibo Road, Pu Dong New District, Shanghai 201203,  
People's Republic of China  
Phone: +86-21-5027-3200 Fax: +86-21-5027-3299

##### **Ricoh Electronic Devices Shanghai Co., Ltd.**

##### **Shenzhen Branch**

1205, Block D (Jinlong Building), Kingkey 100, Hongbao Road, Luohu District,  
Shenzhen, China  
Phone: +86-755-8348-7600 Ext 225

##### **Ricoh Electronic Devices Co., Ltd.**

##### **Taipei office**

Room 109, 10F-1, No.51, Hengyang Rd., Taipei City, Taiwan (R.O.C.)  
Phone: +886-2-2313-1621/1622 Fax: +886-2-2313-1623