

2ch. PWM Step-up / Inverting DC/DC Converter with Synchronous Rectifier for AMOLED / LCD

NO.EA-283-191114

OUTLINE

The R1286K 2ch DC/DC converter is designed for AMOLED display power source. It contains a step up DC/DC converter and an inverting DC/DC converter.

Step up DC/DC converter generates boosted output voltage to 4.6 V to 5.8 V (Selectable). Inverting DC/DC converter generates negative voltage down to -2.0 V to -6.0 V (Selectable) that is dynamically adjustable with single wire interface signal. R1286K consist of a voltage reference, error amplifiers, an oscillator, PWM control circuits, over current protection circuits, short protection circuits, an under voltage lockout circuit (UVLO), thermal shutdown circuit, a NMOS driver and a synchronous PMOS switch for boost converter, a PMOS driver and a synchronous NMOS switch for inverting converter, and so on. High efficiency boost and inverting DC/DC converters can be composed with two external inductors and three capacitors.

FEATURES

- Operating Voltage 2.3 V to 5.5 V

[Step-up DC/DC Converter (CH1)]

- Selectable Output Voltage (V_{OUTP}) R1286KxxxX⁽¹⁾: 4.6 V to 5.8 V (0.1V Step)
- Externally Adjustable Output Voltage R1286K001B: 4.6 V to 5.8 V
- Maximum Output Current R1286K0xxX⁽¹⁾ / R1286K001B: 250 mA
R1286K1xxX⁽¹⁾: 300 mA
- V_{OUTP} Voltage Load Regulation Typ. ± 5 mV
- V_{OUTP} Voltage Line Transient Response Typ. ± 10 mV

[Inverting DC/DC Converter (CH2)]

- Dynamically Adjustable Output Voltage (V_{OUTN}) ... -2.0 V to -6.0 V (Fixed Rate: 3.0 V, 0.1 V Step)
- Selectable Single Wire (S-Wire) I/F R1286KxxxX⁽¹⁾: Default value (0.1 V Step)
- Externally Adjustable Output Voltage R1286K001B: -2.0 V to -6.0 V
- Maximum Output Current R1286K0xxX⁽¹⁾ / R1286K001B: 250 mA
R1286K1xxX⁽¹⁾: 300 mA
- V_{OUTN} Voltage Load Regulation Typ. ± 5 mV
- V_{OUTN} Voltage Line Transient Response Typ. ± 10 mV

[Controller]

- Internal Start-up Sequence Control with Soft-start Operation
- Auto Discharge Operation for Both Outputs
- Short circuit protection
- Internal timer-latch protection Typ. 16 ms or 40 ms
- Maximum duty cycle Typ. 85% (CH1) / Typ. 90% (CH2)

⁽¹⁾ X : A to N (Provided except B and I)

R1286K

NO.EA-283-191114

- LX peak current limit R1286K0xxX⁽¹⁾ : Typ. 1.0 A (CH1), 1.5 A (CH2)
R1286K1xxX⁽¹⁾: Typ. 1.1 A (CH1)、1.8 A (CH2)
- UVLO(Under voltage lock out) protection Typ. 2.05 V
- Thermal Shutdown Typ. 150°C
- Operating Frequency 1750kHz
- Package DFN(PLP)2730-12

APPLICATION

- Fixed voltage power supply for portable equipment
- Fixed voltage power supply for AMOLED, LCD

SELECTION GUIDE

The inverting output voltage (V_{OUTN}), the positive output voltage (V_{OUTP}) and the versions of the inverting output voltage are user-selectable options.

Product Name	Package	Quantity per Reel	Pb Free	Halogen Free
R1286K\$xx*-TR	DFN(PLP)2730-12	5,000pcs	Yes	Yes

\$: Specify the delay time for timer latch ⁽¹⁾.

(0) Typ.16msec

(1) Typ.40msec

xx: Specify the set output voltages (V_{SET}) for default value of V_{OUTx} and V_{ONDEF} ⁽²⁾

* : Specify setting methods for V_{OUTN} and V_{OUTP} .

V_{ONDEF} : V_{OUTN} default value⁽³⁾ (Internal fixed value at shipping)

V_{ONMIN} : V_{OUTN} minimum value with S-Wire

V_{ONMAX} : V_{OUTN} maximum value with S-Wire

t_{TRA} : Variable time per 0.1V with S-Wire ⁽⁴⁾

*	Designation for Settings of V_{OUTx}	V_{ONDEF}	V_{ONMIN}	V_{ONMAX}	t_{TRA}	
A	V_{OUTP} / V_{OUTN} Fixed Output Voltage type ⁽⁵⁾	-5.4 V to -2.4 V	-5.4 V	-2.4 V	10 ms	
B	V_{OUTP} / V_{OUTN} Adjustable Output Voltage type	-	-	-	-	
C		-5.0 V to -2.4 V	-5.0 V	-2.0 V	10 ms	
D		-5.2 V to -2.4 V	-5.2 V	-2.2 V	10 ms	
E		-5.6 V to -2.6 V	-5.6 V	-2.6 V	10 ms	
F		-5.8 V to -2.8 V	-5.8 V	-2.8 V	10 ms	
G		-6.0 V to -3.0 V	-6.0 V	-3.0 V	10 ms	
H		V_{OUTP} / V_{OUTN} Fixed Output Voltage type	-5.0 V to -2.4 V	-5.0 V	-2.0 V	360 μ s
J		-5.4 V to -2.4 V	-5.4 V	-2.4 V	360 μ s	
K	-5.6 V to -2.6 V	-5.6 V	-2.6 V	360 μ s		
L	-5.8 V to -2.8 V	-5.8 V	-2.8 V	360 μ s		
M	-6.0 V to -3.0 V	-6.0 V	-3.0 V	360 μ s		
N	-5.2 V to -2.4 V	-5.2 V	-2.2 V	360 μ s		

⁽¹⁾ Fixed Output Voltage type only can select the delay time of 40 msec (Typ).

⁽²⁾ Refer to *Voltage Combination List* for details.

⁽³⁾ Selectable in 0.1V step

⁽⁴⁾ Refer to the *TIMING CHART of S-Wire* for details.

⁽⁵⁾ Dynamically adjustable output voltage with S-Wire

R1286K

NO.EA-283-191114

Output voltage combination list

V_{SET} codes (xx)	V_{OUTP}	V_{ONDEF}
01	Setting by external resistor	Setting by external resistor
02	4.6 V	-4.9 V
03	5.8 V	-6.0 V
04	4.8 V	-4.9 V
05	5.4 V	-5.4 V
06	5.0 V	-5.0 V
07	5.0 V	-3.5 V
08	5.6 V	-5.6 V
09	5.8 V	-5.8 V
10	5.5 V	-5.5 V
11	4.6 V	-4.4 V

BLOCK DIAGRAMS

R1286KxxxX⁽¹⁾ (Fixed Output Voltage Type)

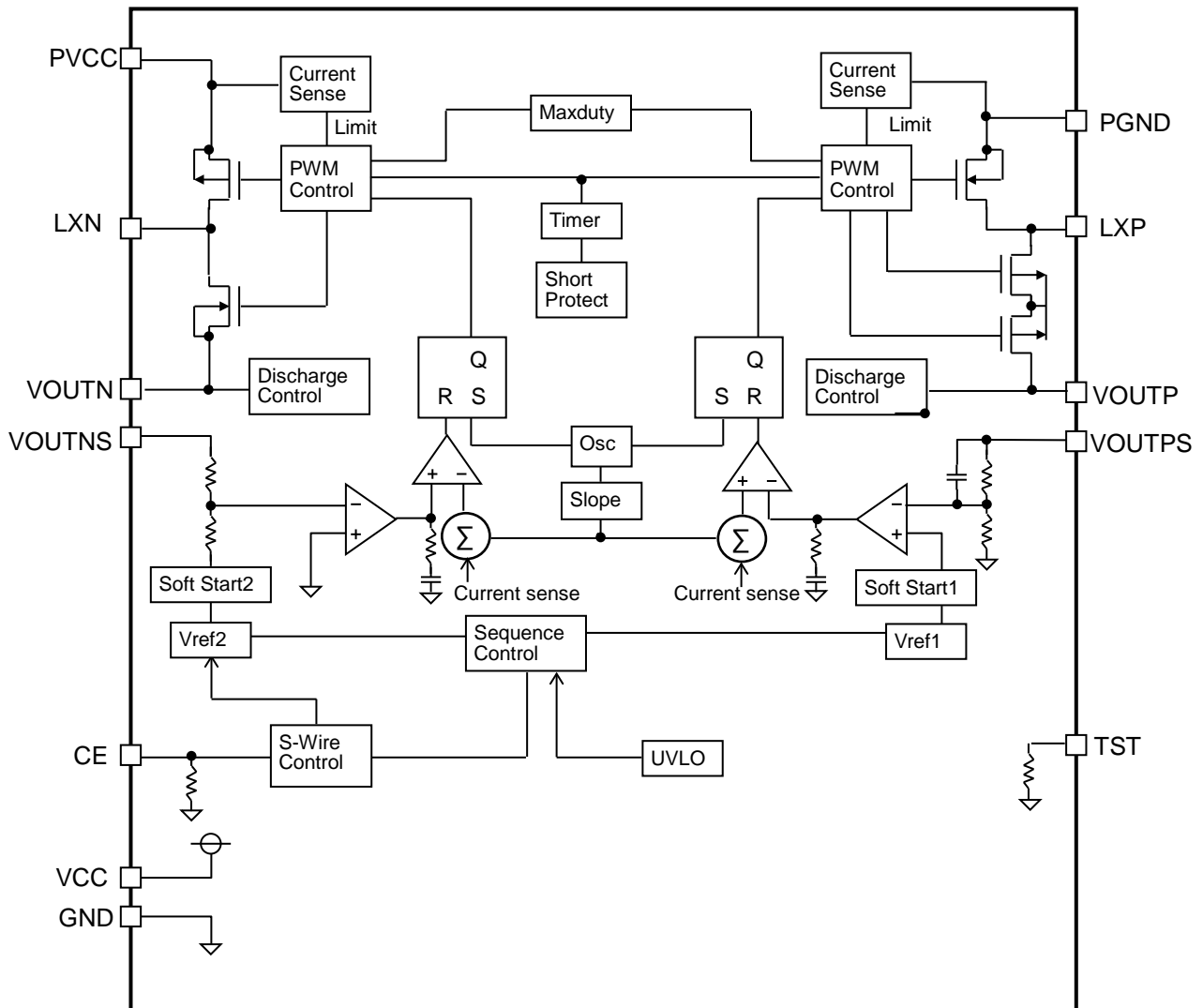

R1286KxxxX Block Diagram

⁽¹⁾ X : A to N (Provided, except "B" and "I")

R1286K

NO.EA-283-191114

R1286K001B (Adjustable Output Voltage Type)

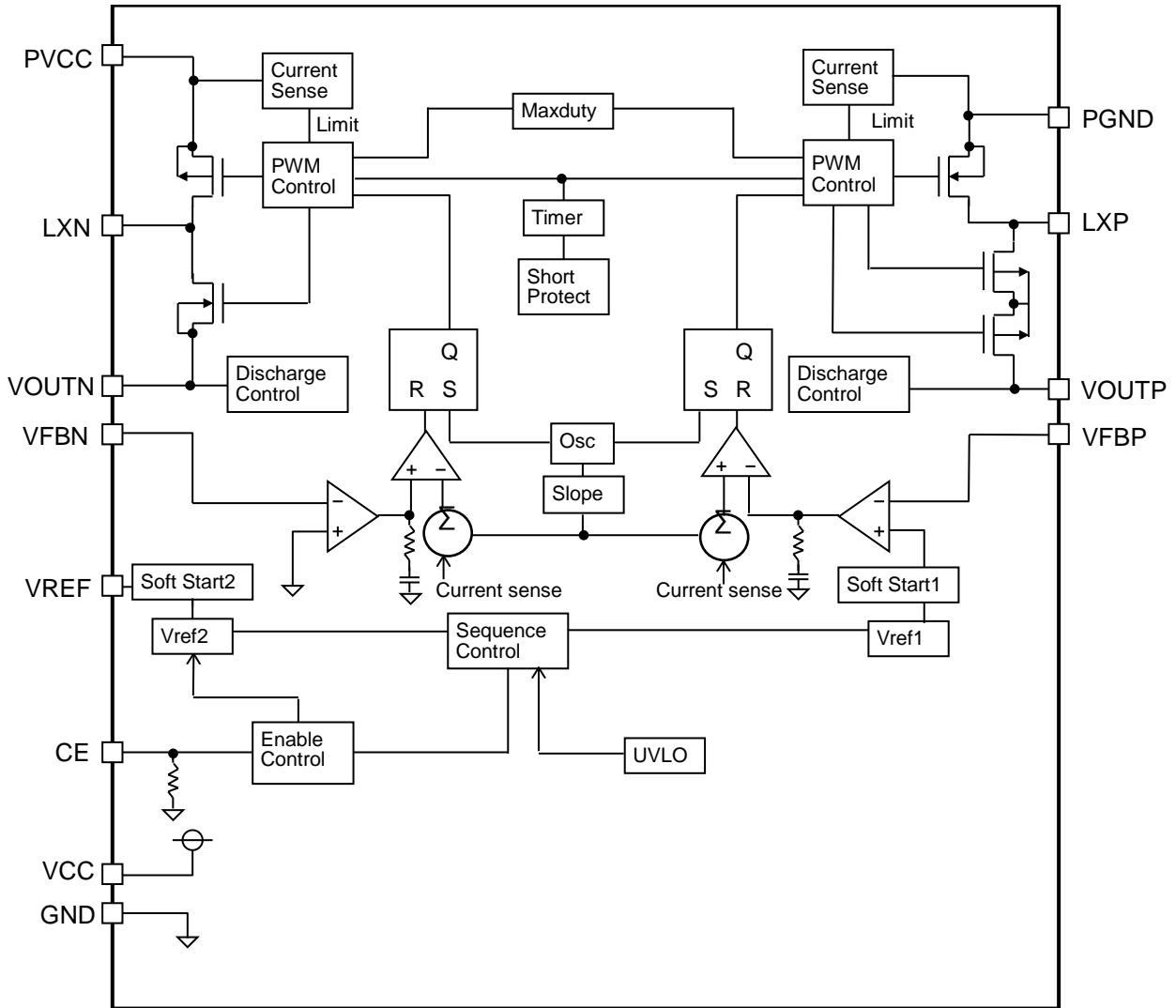

R1286K001B Block Diagram

PIN DESCRIPTION

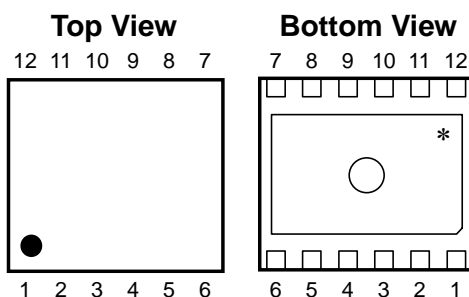

R1286K (DFN(PLP)2730-12) Pin Configuration

R1286K Pin Description

Pin No.	Symbol		Description
	R1286KxxxX ⁽¹⁾	R1286K001B	
1	VOUTNS	VFBN	Feed Back Pin for Inverting DC/DC
2	VOUTN	VOUTN	Outout Pin for Inverting DC/DC
3	LXN	LXN	Switching Pin for Inverting DC/DC
4	PVCC	PVCC	Power Input Pin
5	VCC	VCC	Analog Power Input Pin
6	GND	GND	Analog GND Pin
7	PGND	PGND	Power GND Pin
8	LXP	LXP	Switching Pin for Step up DC/DC
9	VOUTP	VOUTP	Output Pin for Step up DC/DC
10	VOUTPS	VFBP	Feed Back Pin for Step up DC/DC
11	CE	CE	Chip Enable and S-Wire Control Input Pin (R1286KxxxX) Chip Enable Pin (R1286KxxxB)
12	TST	VREF	TEST Pin ⁽²⁾ (R1286KxxxX) Reference Voltage Output Pin for Inverting DC/DC (R1286KxxxB)

* The tab on the bottom of the package is substrate level (GND). It is recommended that the tab be connected to the ground plane on the board.

⁽¹⁾ X : A to N (Provided, except "B" and "I")

⁽²⁾ TEST pin must be connected to the GND or leaving it open.

R1286K

NO.EA-283-191114

ABSOLUTE MAXIMUM RATINGS

(GND = PGND = 0 V)

Symbol	Parameter	Rating	Unit
V _{CC}	VCC / PVCC Pin Voltage	-0.3 to 6.0	V
V _{CE}	CE Pin Voltage	-0.3 to 6.0	V
V _{LXP}	LXP Pin Voltage	-0.3 to 6.5	V
V _{OUTP(S)}	VOU TP Pin Voltage	-0.3 to 6.5	V
V _{LXN}	LXN Pin Voltage	V _{CC} - 14 to V _{CC} + 0.3	V
V _{OUTN(S)}	VOU TN Pin Voltage	V _{CC} - 14 to 0.3	V
V _{TST}	TST Pin Voltage [R1286kxxx ⁽¹⁾]	-0.3 to 6.0	V
V _{FBP}	VFBP Pin Voltage [R1286K001B]	-0.3 to 6.0	V
V _{FBN}	VFBN Pin Voltage [R1286K001B]	-0.3 to V _{CC} + 0.3	V
V _{REF}	VREF Pin Voltage [R1286K001B]	-0.3 to V _{CC} + 0.3	V
P _D	Power Dissipation ⁽²⁾ (DFN(PLP)2730-12, JEDEC STD. 51-7)	3100	mW
T _j	Junction Temperature Range	-40 to 125	°C
T _{stg}	Storage Temperature Range	-55 to 125	°C

ABSOLUTE MAXIMUM RATINGS

Electronic and mechanical stress momentarily exceeded absolute maximum ratings may cause the permanent damages and may degrade the lifetime and safety for both device and system using the device in the field. The functional operation at or over these absolute maximum ratings is not assured.

RECOMMENDED OPERATING CONDITIONS

Symbol	Parameter	Rating	Unit
V _{CC}	Operating Input Voltage	2.3 to 5.5	V
T _a	Operating Temperature Range	-40 to 85	°C

RECOMMENDED OPERATING CONDITIONS

All of electronic equipment should be designed that the mounted semiconductor devices operate within the recommended operating conditions. The semiconductor devices cannot operate normally over the recommended operating conditions, even if when they are used over such conditions by momentary electronic noise or surge. And the semiconductor devices may receive serious damage when they continue to operate over the recommended operating conditions.

⁽¹⁾ X : A to N (Provided, except "B" and "I")

⁽²⁾ Refer to *POWER DISSIPATION* for detailed information.

ELECTRICAL CHARACTERISTICS

The specifications surrounded by are guaranteed by Design Engineering at $-40^{\circ}\text{C} \leq T_a \leq 85^{\circ}\text{C}$.

R1286K Electrical Characteristics

($T_a = 25^{\circ}\text{C}$)

Symbol	Parameter	Conditions	Min.	Typ.	Max.	Unit
I_{CC}	VCC Consumption Current (at no switching)	$V_{CC}=5.5\text{V}$		1.2		mA
$I_{STANDBY}$	Standby Current	$V_{CC}=V_{LXP}=5.5\text{V}$, $V_{CE}=V_{LXN}=0\text{V}$		0.1	5	μA
V_{UVLO1}	UVLO Detection Voltage	Falling	1.95	2.05	2.15	V
V_{UVLO2}	UVLO Release Voltage	Rising		$V_{UVLO1} + 0.10$	2.28	V
f_{OSC}	Oscillator Frequency	$V_{CC}=3.7\text{V}$	1500	1750	2000	kHz
V_{CEH}	CE Pin Input Voltage, high	$V_{CC}=5.5\text{V}$	1.2			V
V_{CEL}	CE Pin Input Voltage, low	$V_{CC}=2.3\text{V}$			0.4	V
R_{CE}	CE Pin Pull-down Resistance	$V_{CC}=3.7\text{V}$		160		k Ω
T_{TSD}	Thermal Shutdown Detection Temperature	$V_{IN}=3.7\text{V}$		150		$^{\circ}\text{C}$
T_{TSR}	Thermal Shutdown Release Temperature	$V_{IN}=3.7\text{V}$		125		$^{\circ}\text{C}$

[R1286K0xxx]

t_{DLY}	Delay Time for Protection	$V_{CC}=3.7\text{V}$	8	16	24	ms
-----------	---------------------------	----------------------	---	----	----	----

[R1286K1xxX⁽¹⁾]

t_{DLY}	Delay Time for Protection	$V_{CC}=3.7\text{V}$	32	40	48	ms
-----------	---------------------------	----------------------	----	----	----	----

■ Set-up DC/DC Converter (CH1)

Maxduty1	Maximum Duty Cycle 1	$V_{CC}=3.7\text{V}$		85		%
I_{VOUTP}	V_{OUTP} Discharge Current	$V_{CC}=3.7\text{V}$, $V_{OUTP}=0.1\text{V}$		1.1		mA
t_{SSP}	CH1 Soft-start Time	$V_{CC}=3.7\text{V}$	1.6	2.4	3.0	ms
R_{LXP}	LXP Pin On-resistance	$V_{CC}=3.7\text{V}$		400		m Ω
R_{SYNCP}	Synchronous SW Pch.On-resistance	$V_{CC}=3.7\text{V}$		700		m Ω

[R1286K0xxx]

I_{LIMLXP}	LXP Pin Limit Current	$V_{CC}=3.7\text{V}$		1.0		A
--------------	-----------------------	----------------------	--	-----	--	---

[R1286K1xxX]

I_{LIMLXP}	LXP Pin Limit Current	$V_{CC}=3.7\text{V}$		1.1		A
--------------	-----------------------	----------------------	--	-----	--	---

[R1286KxxxX]

V_{OUTP}	V_{OUTP} Voltage Tolerance	$V_{CC}=3.7\text{V}$	$\times 0.991$	V_{SET}	$\times 1.009$	V
------------	------------------------------	----------------------	----------------	-----------	----------------	---

⁽¹⁾ X : A to N (Provided, except "B" and "I")

R1286K

NO.EA-283-191114

The specifications surrounded by are guaranteed by Design Engineering at $-40^{\circ}\text{C} \leq T_a \leq 85^{\circ}\text{C}$.

R1286K Electrical Characteristics (Continued)

($T_a = 25^{\circ}\text{C}$)

Symbol	Parameter	Conditions	Min.	Typ.	Max.	Unit
[R1286K001B]						
V _{FBP}	V _{FBP} Voltage Tolerance	V _{CC} =3.7V	0.985	1.000	1.015	V
I _{FBP}	V _{FBP} Input Current	V _{CC} =5.5V, V _{FBP} =0V or 5.5V	-0.1		0.1	μA

■ Inverting DC/DC Converter (CH2)

Maxduty2	Maximum Duty Cycle 2	V _{CC} =3.7V		90		%
I _{VO_{UTN}}	V _{OUTN} Discharge Current	V _{CC} =3.7V, V _{OUTN} =-0.1		0.3		mA
R _{LXN}	LXN Pin On-resistance	V _{CC} =3.7V		400		mΩ
R _{SYN_{CN}}	Synchronous SW Nch.On-resistance	V _{CC} =3.7V		600		mΩ

[R1286K0xxx]

I _{LIMLXN}	LXN Pin Limit Current	V _{CC} =3.7V		1.5		A
---------------------	-----------------------	-----------------------	--	-----	--	---

[R1286K1xxX]

I _{LIMLXN}	LXN Pin Limit Current	V _{CC} =3.7V		1.8		A
---------------------	-----------------------	-----------------------	--	-----	--	---

[R1286KxxxX]

V _{ONDEF}	V _{OUTN} Default Voltage Tolerance	V _{CC} =3.7V, selectable between V _{ONMIN} and V _{ONMAX} at shipping	V _{SET} -70	V _{SET}	V _{SET} +70	mV
V _{ONMIN}	V _{OUTN} Minimum Voltage Tolerance	V _{CC} =3.7V, selectable between -2.0V and -3.0V at shipping	V _{SET} -70	V _{SET}	V _{SET} +70	mV
V _{ONMAX}	V _{OUTN} Maximum Voltage Tolerance	V _{CC} =3.7V	V _{SET} -70	V _{ONMIN} +3.0V	V _{SET} +70	mV
V _{OUTN}	V _{OUTN} Voltage Tolerance (S-Wire)	V _{CC} =3.7V (Guaranteed by design engineering)	V _{SET} -80	V _{SET}	V _{SET} +80	mV
t _{SSN}	Soft-start Time for CH2	V _{CC} =3.7V	1.6x V _{ONDEF} / -4.9	2.3x V _{ONDEF} / -4.9	3.0x V _{ONDEF} / -4.9	ms

[R1286K001B]

V _{FBN}	V _{FBN} Voltage Tolerance	V _{CC} =3.7V	-25	0	25	mV
V _{REF}	V _{REF} Voltage Tolerance	V _{CC} =3.7V	1.18 +V _{FBN}	1.2 +V _{FBN}	1.22 +V _{FBN}	V
I _{FBN}	V _{FBN} Input Current	V _{CC} =5.5V, V _{FBN} =0V or 5.5V	-0.1		0.1	μA
t _{SSN}	Soft-start Time for CH2	V _{CC} =3.7V	1.6	2.8	3.6	ms

All test items listed under *Electrical Characteristics* are done under the pulse load condition ($T_j \approx T_a = 25^{\circ}\text{C}$).

THEORY OF OPERATION

Start-up Sequence

When CE level turns from 'L' to 'H' level, the softstart of CH1 starts the operation. After detecting output voltage of CH1(V_{OUTP}) as the nominal level, the soft start of CH2 starts the operation.

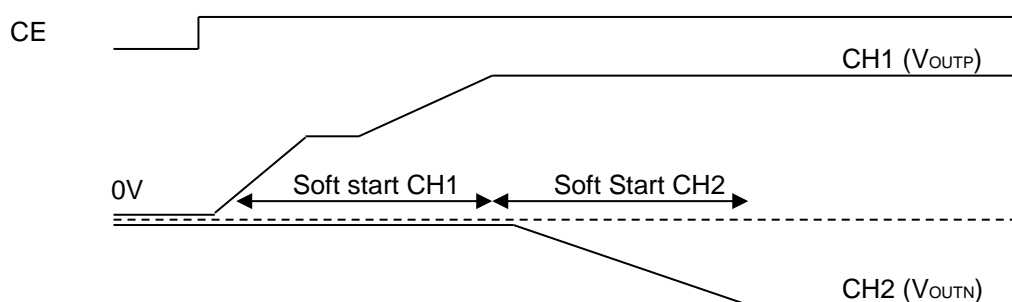

Auto Discharge Function

When CE level turns from 'H' to 'L' level, the R1286K goes into standby mode and switching of the outputs of L_{XP} and L_{XN} will stop. Then discharge switch between V_{OUTN} and GND and switch between V_{OUTP} and GND turn on and discharge the negative output voltage and positive output voltage. The positive and negative output voltage is discharged to 0V in standby mode. If V_{CC} voltage became lower than UVLO detect voltage, discharge switches also turn on and discharge output voltage (V_{OUTN} and V_{OUTP}).

In case of timer latch protection, discharge switches will keep off.

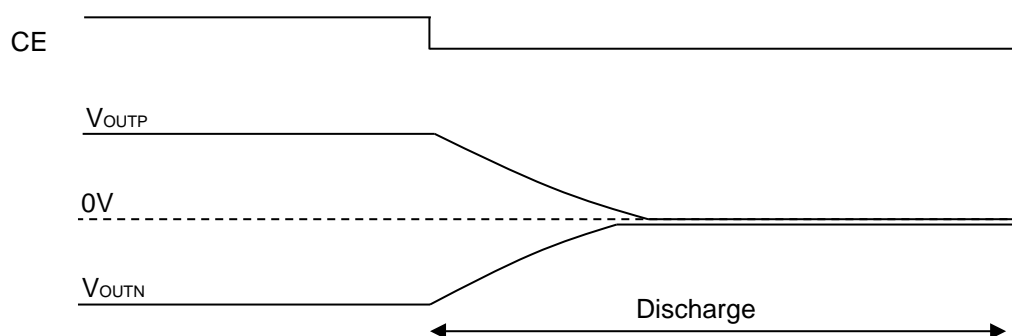

Thermal Shutdown Protection

If the over temperature is detected, internal Mosfet will turn-off soon. And when the temperature get lower than the release temperature, IC is reset and restart the operation.

R1286K

NO.EA-283-191114

Overcurrent Protection and Short-circuit Protection Circuit Timer

The over current protection circuit supervises the peak current of the inductor (The current passing through NMOS transistor of CH1 and PMOS transistor of CH2) with respect to each switching cycle. If the peak current exceeds the L_x current limit (I_{LIMLXP} or I_{LIMLXN}), the over current protection circuit turns off the NMOS transistor of CH1 or PMOS transistor of CH2. If the over current continues more than the protection delay time (T_{DLY}), the short current protection circuit latches the built-in driver at OFF state and stops the operation of DC/DC converter.

* L_x limit current (I_{LIMLXP} or I_{LIMLXN}) and the protection delay time (T_{DLY}) can be easily affected by self-heating and ambient environment. The drastic drop of output voltage or the unstable output voltage caused by the short-circuiting may affect the protection operation and the delay time.

To release the latch over current protection, reset the IC by inputting "L" into CE pin or by making the input voltage lower than the UVLO detector threshold (V_{UVLO1}).

During the softstart operation of CH1 and CH2, the timer operates until detecting output voltage of CH2 (V_{OUTN}) as the nominal level. Therefore, even if the softstart cannot finish correctly because of the short circuit, the protection timer function will be able to work correctly.

Sequence with S-Wire Control for V_{OUTN} (R1286KxxxX⁽¹⁾)

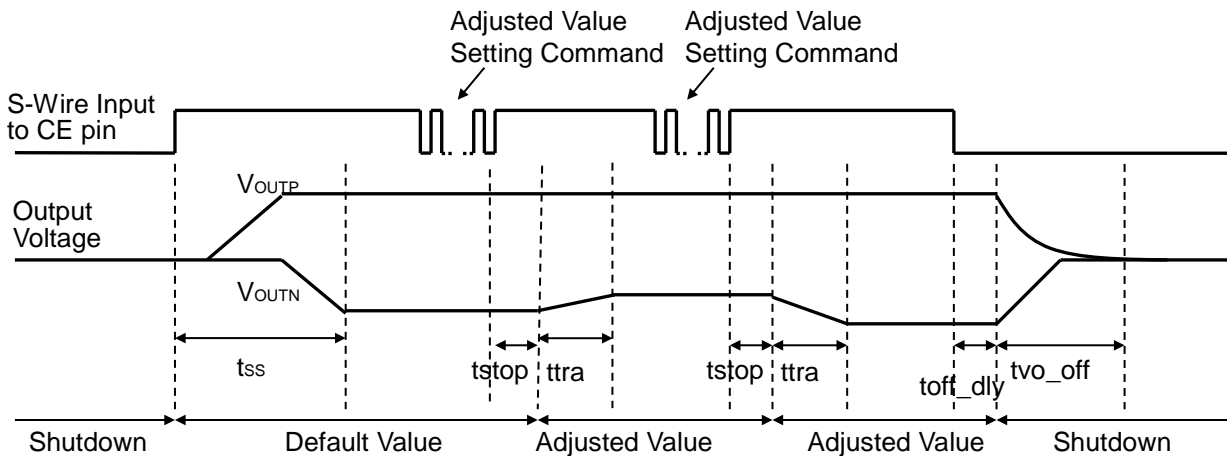

■ Default Value Driving

V_{OUTP} rises up first and secondarily V_{OUTN} goes down. In this time V_{OUTN} is set V_{ONDEF} .

Soft-start time (t_{ss}) = $2.4\text{ms} + 2.3 \times V_{ONDEF} / -4.9$ (Typ.)

⁽¹⁾ X : A to N (Provided, except "B" and "I")

■ Adjusted Value Driving

After receiving the adjusted value setting command, V_{OUTN} is changed to the target voltage in multiple steps method. Adjusted value is also selectable with pulse count (Please refer to V_{OUTN} VARIABLE TABLE).

In the case of R1286KxxxA/C/D/E/F/G,

V_{OUTN} change 0.01V step in every 1ms and it takes 10ms per 0.1V that is minimum step for V_{OUTN} setting value.

In the case of R1286KxxxH/J/K/L/M/N,

V_{OUTN} change 0.01V step in every 36 μ s and it takes 360 μ s per 0.1V that is minimum step for V_{OUTN} setting value.

[Multiple steps method (In case of $\Delta V_{OUT} = 0.1V$)]

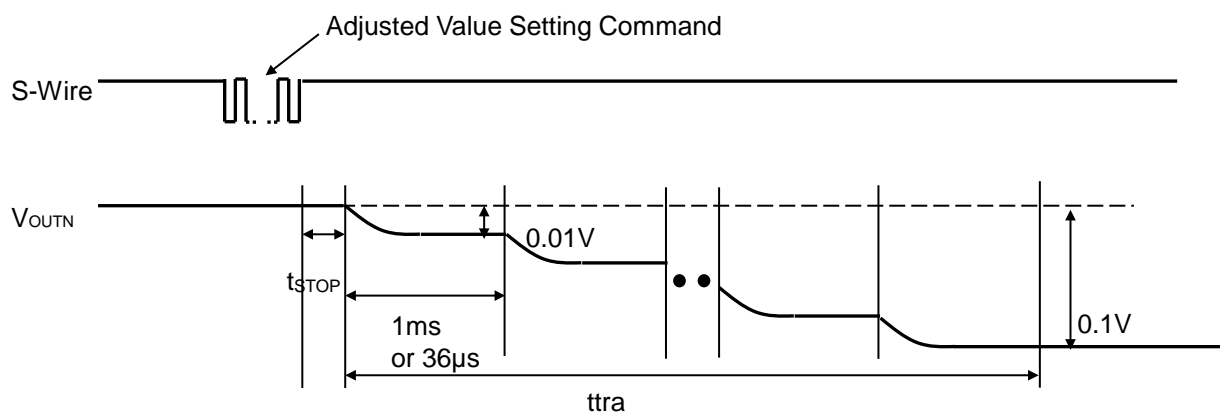

- Multiple step rate : 0.01V / 1ms or 36 μ s
- Transient time (ttra) for minimum ΔV_{OUTN} : 10 ms or 0.36 ms

R1286K

NO.EA-283-191114

V_{OUTN} Variable Table

The adjusted value setting command are operated with S-Wire input (pulse count) as the following table.

V_{OUTN} Variable Table (31 steps)

BIT (Pulse Count)	R1286KxxxA	R1286KxxxG
0 (Default)	-2.4 to -5.4	-3.0 to -6.0
1	-5.4	-6.0
2	-5.3	-5.9
3	-5.2	-5.8
4	-5.1	-5.7
5	-5.0	-5.6
6	-4.9	-5.5
7	-4.8	-5.4
8	-4.7	-5.3
9	-4.6	-5.2
10	-4.5	-5.1
11	-4.4	-5.0
12	-4.3	-4.9
13	-4.2	-4.8
14	-4.1	-4.7
15	-4.0	-4.6
16	-3.9	-4.5
17	-3.8	-4.4
18	-3.7	-4.3
19	-3.6	-4.2
20	-3.5	-4.1
21	-3.4	-4.0
22	-3.3	-3.9
23	-3.2	-3.8
24	-3.1	-3.7
25	-3.0	-3.6
26	-2.9	-3.5
27	-2.8	-3.4
28	-2.7	-3.3
29	-2.6	-3.2
30	-2.5	-3.1
31	-2.4	-3.0

Timing Chart for Commands with S-Wire

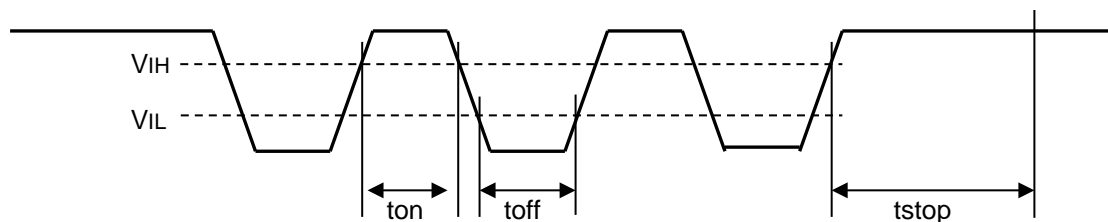

Timing specification

Item	Symbol	Min.	Typ.	Max.	Unit
Soft-start time	tss		tssp + tssn		ms
V_{OUTN} Transient time (1 step)	ttra		10 (R1286KxxxA/C/D/E/F/G) 0.36 (R1286KxxxH/J/K/L/M/N)		ms
Turn-off delay time	toff_dly	70	90	110	μ s
V_{OUT} discharge time	tvo_off		2.0		ms
CE pin input voltage, high	V_{IH}	1.2			V
CE pin input voltage, low	V_{IL}			0.4	V
S-Wire time, high	ton	2	10	20	μ s
S-Wire time, low	toff	2	10	20	μ s
S-Wire command stop time	tstop	70	90	110	μ s

Operation of Set-up DC/DC Converter (CH1) and Output Current

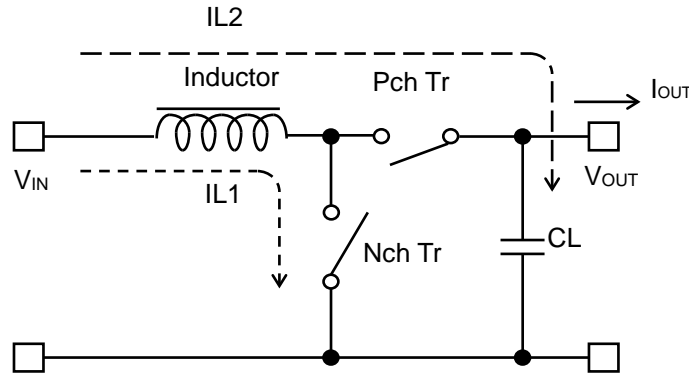

Basic Circuit

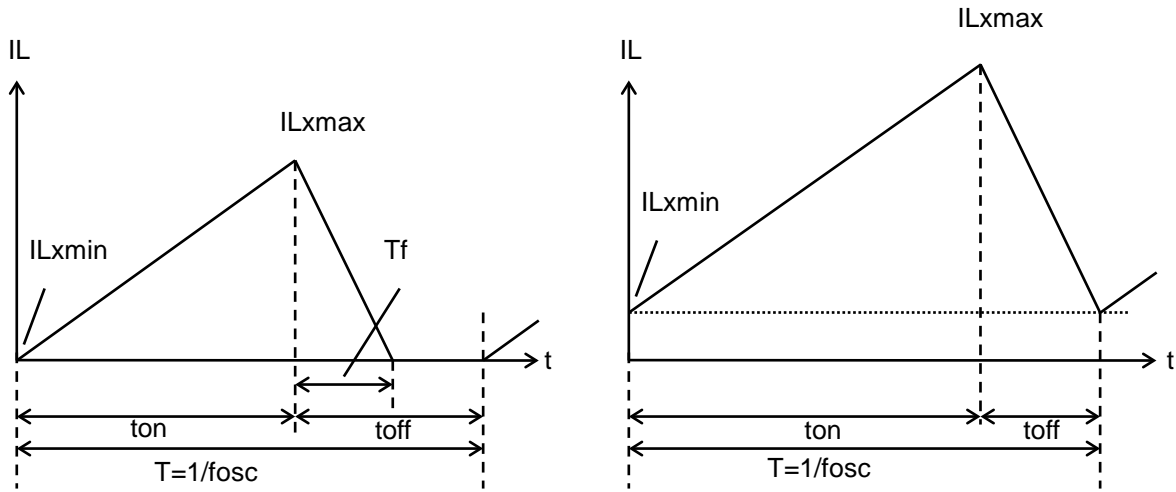

Discontinuous Inductor Current Mode

Continuous Inductor Current Mode

Inductor Current Waveforms (IL) through Inductor (L)

The PWM control type of CH1 has two operation modes characterized by the continuity of inductor current: discontinuous inductor current mode and continuous inductor current mode.

When a NMOS Tr. is in On-state, the voltage to be applied to the inductor (L) is described as V_{IN} . An increase in the inductor current ($IL1$) can be written as follows:

$$IL1 = V_{IN} \times t_{on} / L \dots \dots \dots \text{Equation 1}$$

In the CH1 circuit, the energy accumulated during the On-state is transferred into the capacitor even in the Off-state. A decrease in the inductor current ($IL2$) can be written as follows:

$$IL2 = (V_{OUT} - V_{IN}) \times t_f / L \dots \dots \dots \text{Equation 2}$$

In the PWM control, IL1 and IL2 become continuous when $t_f = t_{off}$, which is called continuous inductor current mode. When the device is in continuous inductor current mode and operates in steady-state conditions, the variations of IL1 and IL2 are same:

$$V_{IN} \times t_{on} / L = (V_{OUT} - V_{IN}) \times t_{off} / L \dots\dots\dots \text{Equation 3}$$

Therefore, the duty cycle in continuous inductor current mode is:

$$\text{Duty} = t_{on} / (t_{on} + t_{off}) = (V_{OUT} - V_{IN}) / V_{OUT} \dots\dots\dots \text{Equation 4}$$

If the input voltage (V_{IN}) is equal to V_{OUT} , the output current (I_{OUT}) is:

$$I_{OUT} = V_{IN}^2 \times t_{on} / (2 \times L \times V_{OUT}) \dots\dots\dots \text{Equation 5}$$

If I_{OUT} is larger than Equation 5, the device switches to continuous inductor current mode. The L_x peak current flowing through L (I_{Lxmax}) is:

$$I_{Lxmax} = I_{OUT} \times V_{OUT} / V_{IN} + V_{IN} \times t_{on} / (2 \times L) \dots\dots\dots \text{Equation 6}$$

$$I_{Lxmax} = I_{OUT} \times V_{OUT} / V_{IN} + V_{IN} \times T \times (V_{OUT} - V_{IN}) / (2 \times L \times V_{OUT}) \dots\dots\dots \text{Equation 7}$$

The L_x peak current limit circuit operates in both modes if the I_{Lxmax} becomes more than the L_x peak current limit. When considering the input and output conditions or selecting the external components, please pay attention to I_{Lxmax} .

Notes: The above calculations are based on the ideal operation of the device. They do not include the losses caused by the external components or L_x switch. The actual maximum output current will be 70% to 90% of the above calculation results. Especially, if IL is large or V_{IN} is low, it may cause the switching losses.

Operation of Inverting DC/DC Converter (CH2) and Output Current

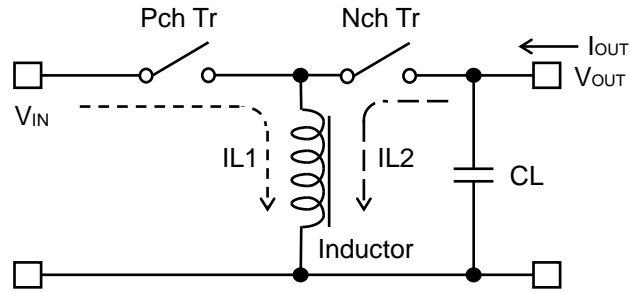

Basic Circuit

Discontinuous Inductor Current Mode

Continuous Inductor Current Mode

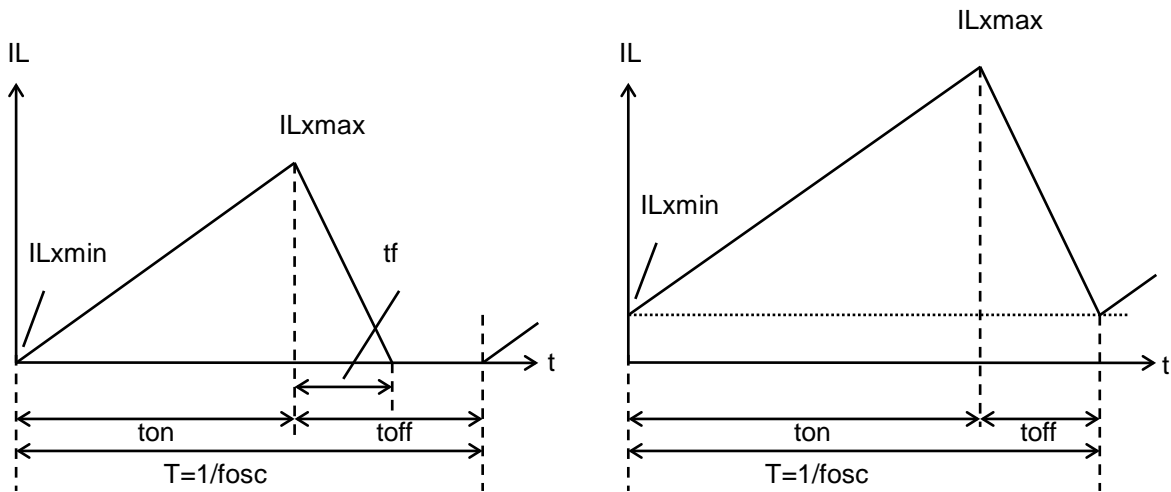

Inductor Current Waveforms (IL) through Inductor (L)

The PWM control type of CH2 has two operation modes characterized by the continuity of inductor current: discontinuous inductor current mode and continuous inductor current mode.

When a PMOS Tr. is in ON-state, the voltage to be applied to the inductor (L) is described as V_{IN} . An increase in the inductor current ($IL1$) can be written as follows:

$$IL1 = V_{IN} \times t_{on} / L \dots \dots \dots \text{Equation 8}$$

In the CH2 circuit, the energy accumulated during the On-state is transferred into the capacitor even in the Off-state. A decrease in the inductor current ($IL2$) can be written as follows:

$$IL2 = |V_{OUT}| \times t_f / L \dots \dots \dots \text{Equation 9}$$

In the PWM control type, when $t_f = t_{off}$, the inductor current will be continuous and the operation of CH2 will be continuous inductor current mode. When the device is in continuous inductor current mode and operates in steady-state conditions, the variation of I_{L1} and I_{L2} are same:

$$V_{IN} \times t_{on} / L = |V_{OUT}| \times t_{off} / L \dots\dots\dots \text{Equation 10}$$

Therefore, the duty cycle in continuous inductor current mode is:

$$\text{Duty} = t_{on} / (t_{on} + t_{off}) = |V_{OUT}| / (|V_{OUT}| + V_{IN}) \dots\dots\dots \text{Equation 11}$$

If the input voltage (V_{IN}) equal to V_{OUT} , the output current (I_{OUT}) is:

$$I_{OUT} = V_{IN}^2 \times t_{on} / (2 \times L \times |V_{OUT}|) \dots\dots\dots \text{Equation 12}$$

If I_{OUT} is larger than Equation 12, the device switches to continuous inductor current mode. The L_x peak current flowing through L (I_{Lxmax}) is:

$$I_{Lxmax} = I_{OUT} \times (|V_{OUT}| + V_{IN}) / V_{IN} + V_{IN} \times t_{on} / (2 \times L) \dots\dots\dots \text{Equation 13}$$

$$I_{Lxmax} = I_{OUT} \times (|V_{OUT}| + V_{IN}) / V_{IN} + V_{IN} \times |V_{OUT}| \times T / \{ 2 \times L \times (|V_{OUT}| + V_{IN}) \} \dots\dots\dots \text{Equation 14}$$

The L_x peak current limit circuit operates in both modes if the I_{Lxmax} becomes more than the L_x peak current limit. When considering the input and output conditions or selecting the external components, please pay attention to I_{Lxmax} .

Notes: The above calculations are based on the ideal operation of the device. They do not include the losses caused by the external components or L_x switch. The actual maximum output current will be 70% to 90% of the above calculation results. Especially, if I_L is large or V_{IN} is low, it may cause the switching losses.

APPLICATION INFORMATION

Typical Application Circuits

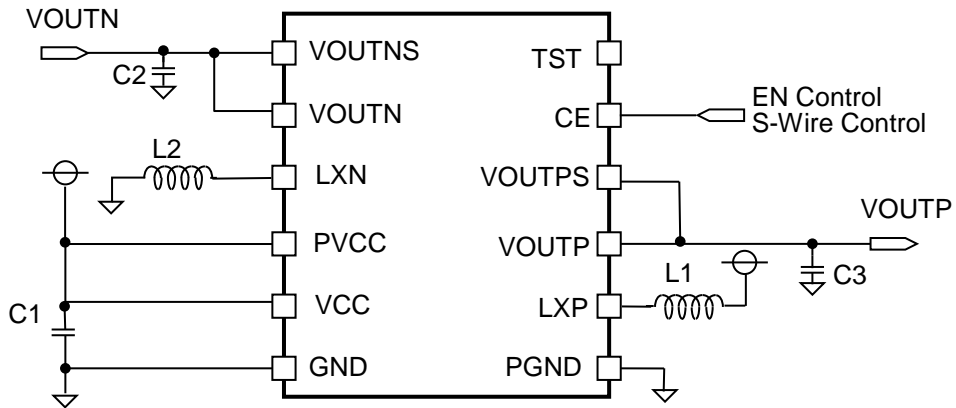

R1286KxxxX (Fixed Output Voltage Type) Typical Application Circuit

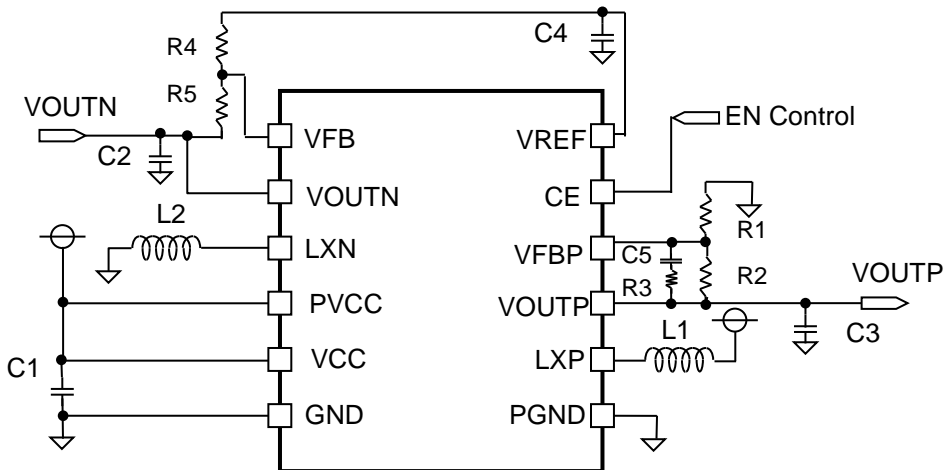

R1286K001B (Adjustable Output Voltage Type) Typical application Circuit

Recommended External Components

Symbol	Description
L1	VLF302510M-4R7M (TDK)、VLF3010S-4R7M (TDK)
L2	VLF4012S-4R7M (TDK)、NR4012T4R7M (TAIYOYUDEN)
C1(C _{IN}), C2(C _{OUTN}), C3(C _{OUTP})	4.7μF、2012size X5R T=0.85max
C4 (C _{REF}) ⁽¹⁾	0.1μF、0603size

⁽¹⁾ R1286K001B Only

Precautions for Selecting External Components

- Place a ceramic capacitor of 4.7μF or more (C1) between VCC pin/PVCC pin and GND pin/ PGND pin.
- Place a ceramic capacitor of 4.7μF or more (C2, C3) between VOUTP pin / VOUTN pin and GND.
- Place a ceramic capacitor of 0.1μF to 2.2μF (C4) between VREF pin and GND. [R1286K001B]
- **Step-up DC/DC Converter Output Voltage Setting [R1286K001B]**
The output voltage V_{OUTP} of the step-up DC/DC converter is controlled with maintaining the V_{FBP} as 1.0V. V_{OUTP} can be set with adjusting the values of R1 and R2 as in the next formula.

$$V_{OUTP} = V_{FBP} \times (R1 + R2) / R1$$

V_{OUTP} can be set from 4.6V to 5.8V. The appropriate value range of R1 is from 20kΩ to 60k Ω.

- **Inverting DC/DC Converter Output Voltage Setting [R1286K001B]**
The output voltage V_{OUTN} of the inverting DC/DC converter is controlled with maintaining the V_{FBN} as 0V. V_{OUTN} can be set with adjusting the values of R1 and R2 as in the next formula.

$$V_{OUTN} = V_{FBN} - (V_{REF} - V_{FBN}) \times R5 / R4$$

V_{OUTN} can be set from -2.0V to -6.0V. The appropriate value range of R4 is from 2.5kΩ to 60kΩ.

- **Phase Compensation of Step-up DC/DC Converter [R1286K001B]**
DC/DC converter's phase may lose 180 degree by external components of L and C and load current. Because of this, the phase margin of the system will be less and the stability will be worse. Therefore, the phase must be gained.

Zero will be formed with R1 and C5.

$$C5 [\text{pF}] = 300 / R1 [\text{k}\Omega]$$

If the noise of the system is large, the output noise affects the feedback and the operation may be unstable. In that case, another resistor R3 will be set. The appropriate value range is from 10Ω to 1kΩ.

TECHNICAL NOTES

The performance of a power source circuit using this device is highly dependent on a peripheral circuit. A peripheral component or the device mounted on PCB should not exceed a rated voltage, a rated current or a rated power. When designing a peripheral circuit, please be fully aware of the following points.

- Wire the bypass capacitor (C1) between the VCC pin, the GND pin, or the PVCC pin as short as possible. The GND pin should be connected to the GND plane of the PCB.
- Wire the GND of the output capacitors (C2, C3) to the GND pin of the device as short as possible.
- The wiring among each GND line of C1, C2, and C3 and the GND pin of the device must be short as possible via the device.
- The wiring between L_{XP} pin, L_{XN} pin and inductor each should be as short as possible and mount output capacitors (C2 and C3) as close as possible to the V_{OUTP}, V_{OUTN} each.
- Input impedance of V_{OUTPS} pin, V_{OUTNS} pin, V_{FBP} pin, and V_{FBN} pin is high, therefore, the external noise may affect the performance. The coupling capacitance between these nodes and switching lines must be as short as possible.
- As shown in the diagrams of the current paths of boost DC/DC converter and the current path of inverting DC/DC converter, the parasitic impedance, inductance, and the capacitance in the parts pointed with red arrows have an influence against the stability of the DC/DC converters and become a cause of the noise. Therefore, such parasitic elements must be made as small as possible. Wiring of the current paths must be short and thick.

【Set-up DCDC】

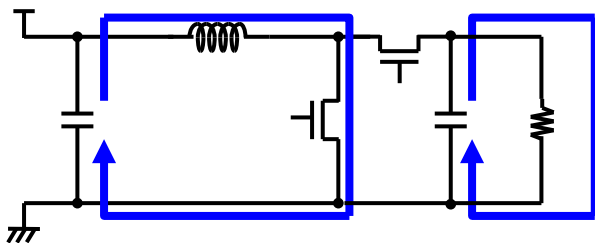

NMOSFET-ON

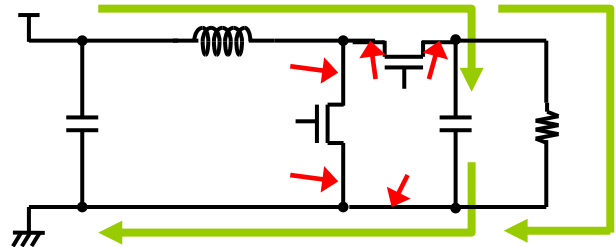

PMOSFET-ON

【Inverting DCDC】

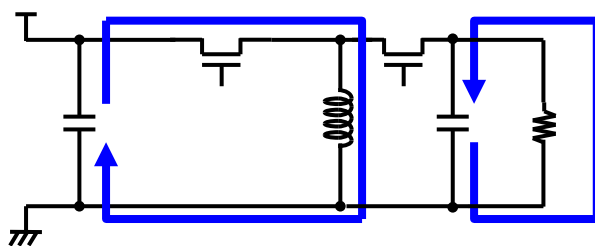

PMOSFET-ON

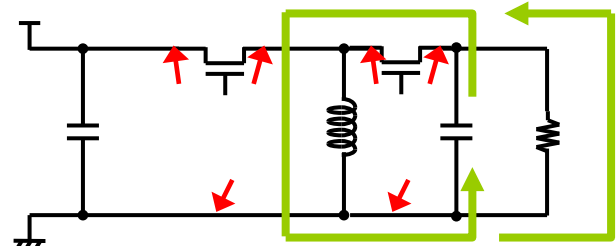

NMOSFET-ON

PCB Layout

R1286K Board Layout [PKG: DNF (PLP) 2730-12]

Top Layer

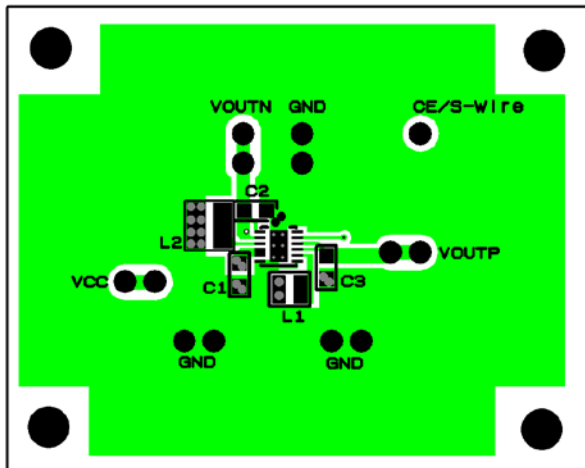

Back Layer

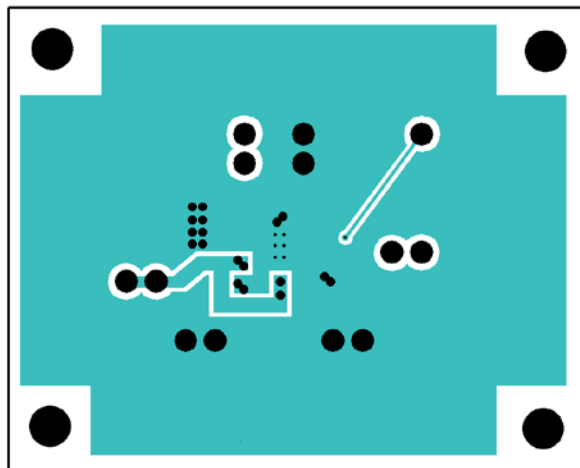

R1286KxxxX⁽¹⁾ (Fixed Output Voltage Type) Board Layout

Top Layer

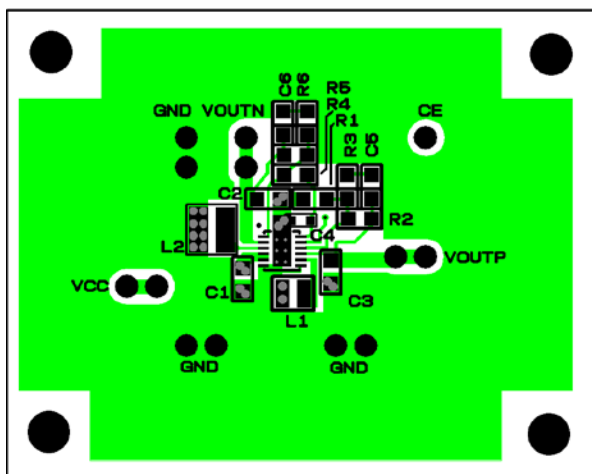

Back Layer

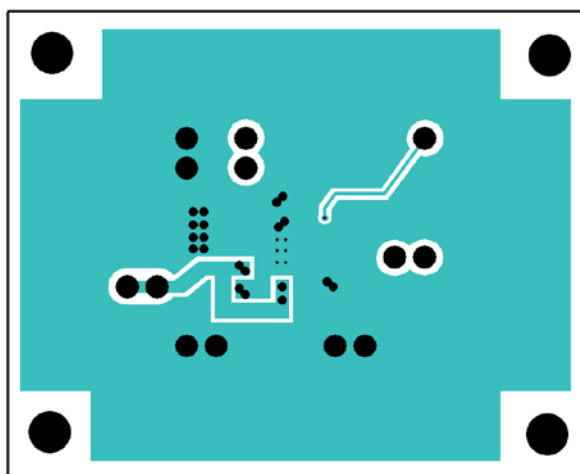

R1286K001B (Adjustable Output Voltage Type) Board Layout

⁽¹⁾ X : A to N (Provided, except "B" and "I")

R1286K

NO.EA-283-191114

TYPICAL CHARACTERISTICS

Typical Characteristics are intended to be used as reference data, they are not guaranteed.

1) Output Voltage vs. Output Current

R1286KxxxX⁽¹⁾ ($V_{OUTP} = 4.6\text{ V}$)

($T_a = 25^\circ\text{C}$)

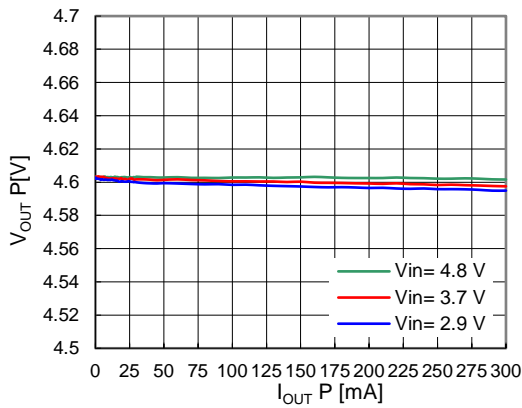

R1286KxxxX ($V_{OUTP} = 5.4\text{ V}$)

($T_a = 25^\circ\text{C}$)

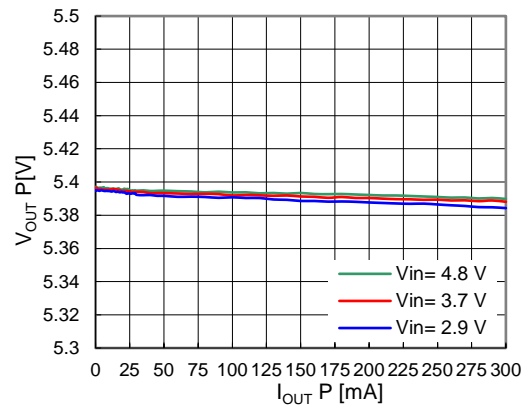

R1286KxxxX ($V_{OUTP} = 5.8\text{ V}$)

($T_a = 25^\circ\text{C}$)

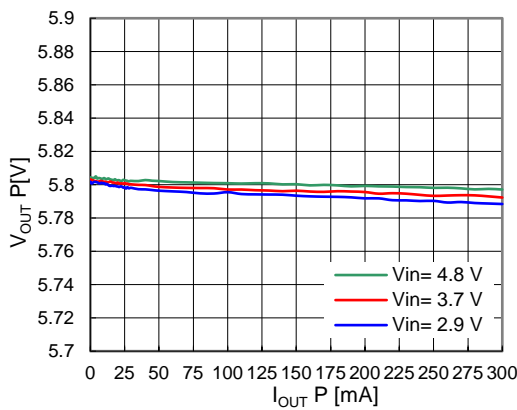

R1286KxxxX ($V_{OUTN} = -4.9\text{ V}$)

($T_a = 25^\circ\text{C}$)

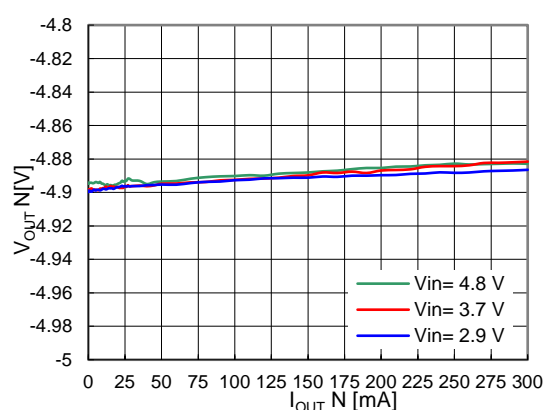

R1286KxxxX ($V_{OUTN} = -5.4\text{ V}$)

($T_a = 25^\circ\text{C}$)

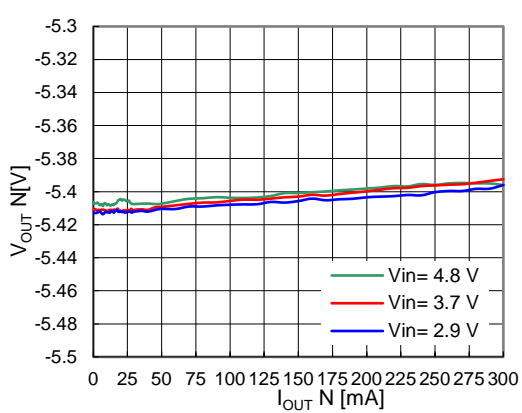

R1286KxxxX ($V_{OUTN} = -6.0\text{ V}$)

($T_a = 25^\circ\text{C}$)

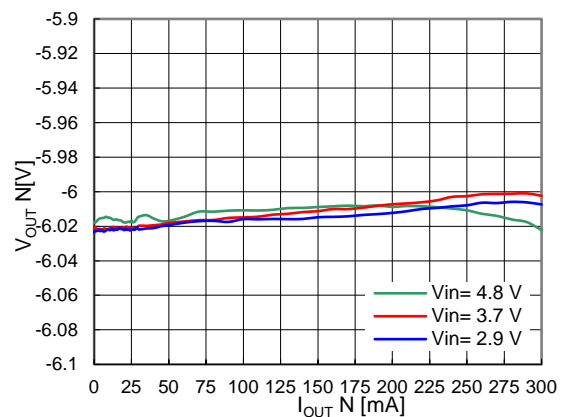

⁽¹⁾X : A to N (Provided, except "B" and "I")

2) Efficiency vs. Output Current

R1286KxxxX ($V_{OUTP} = 4.6\text{ V}$, $V_{OUTN} = -4.9\text{ V}$)
($T_a = 25^\circ\text{C}$)

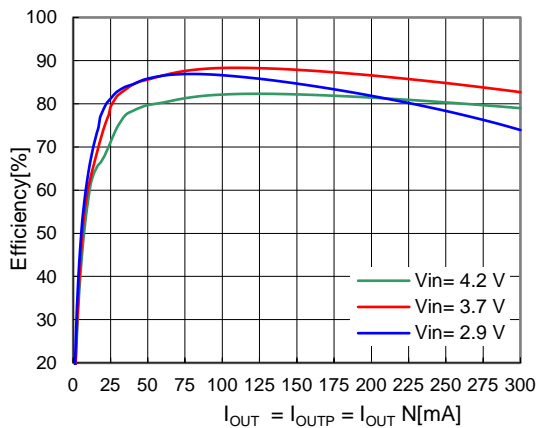

R1286KxxxX ($V_{OUTP} = 5.4\text{ V}$, $V_{OUTN} = -5.4\text{ V}$)
($T_a = 25^\circ\text{C}$)

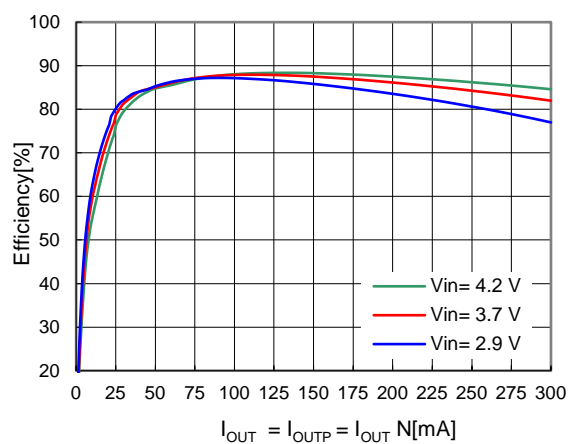

R1286KxxxX ($V_{OUTP} = 5.8\text{ V}$, $V_{OUTN} = -6.0\text{ V}$)
($T_a = 25^\circ\text{C}$)

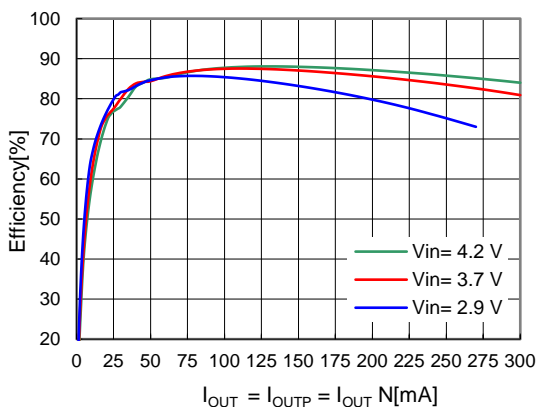

R1286K

NO.EA-283-191114

3) Turn-on/Turn-off Waveform by CE

R1286Kx02A ($V_{IN}=3.7\text{ V}$, $I_{OUTP} = I_{OUTN} = 0\text{ mA}$)

($T_a = 25^\circ\text{C}$)

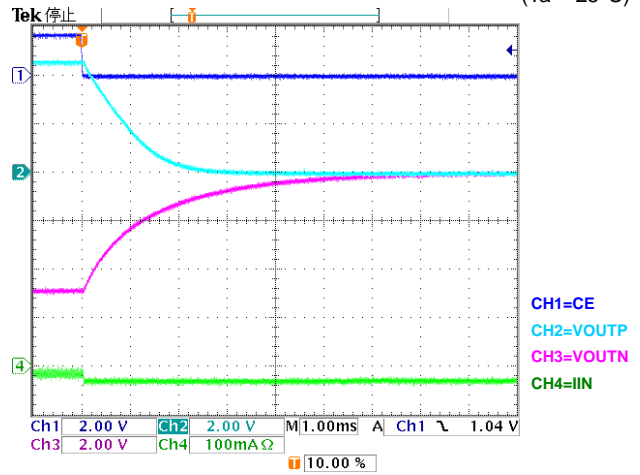
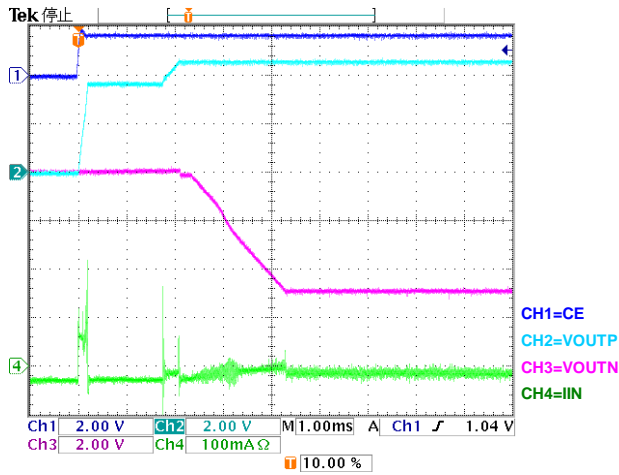

R1286Kx05A ($V_{IN}=3.7\text{ V}$, $I_{OUTP} = I_{OUTN} = 0\text{ mA}$, $C_{OUTP} = C_{OUTN} = 4.7\mu\text{F}$)

($T_a = 25^\circ\text{C}$)

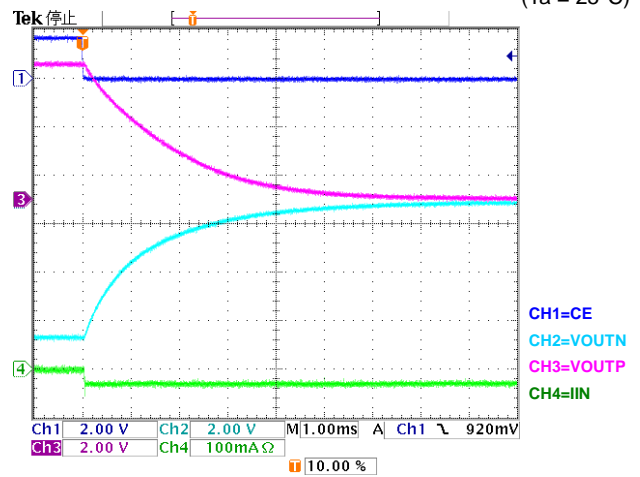
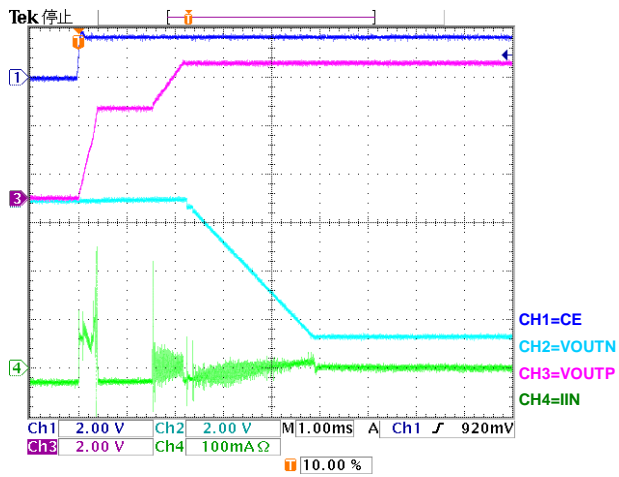

R1286Kx05A ($V_{IN}=3.7\text{ V}$, $I_{OUTP} = I_{OUTN} = 0\text{ mA}$, $C_{OUTP} = 10\mu\text{F} \times 2$, $C_{OUTN} = 4.7\mu\text{F}$)

($T_a = 25^\circ\text{C}$)

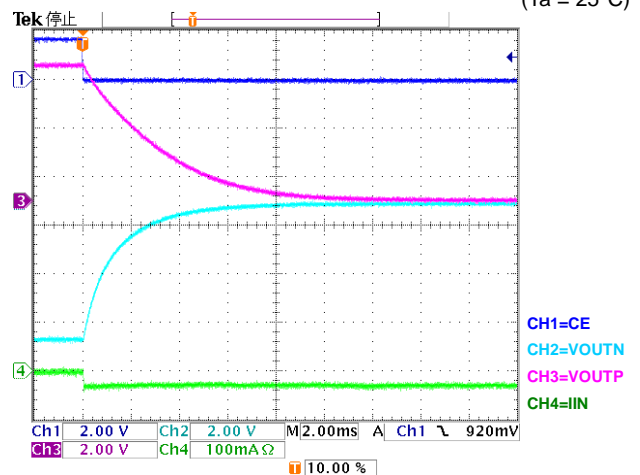
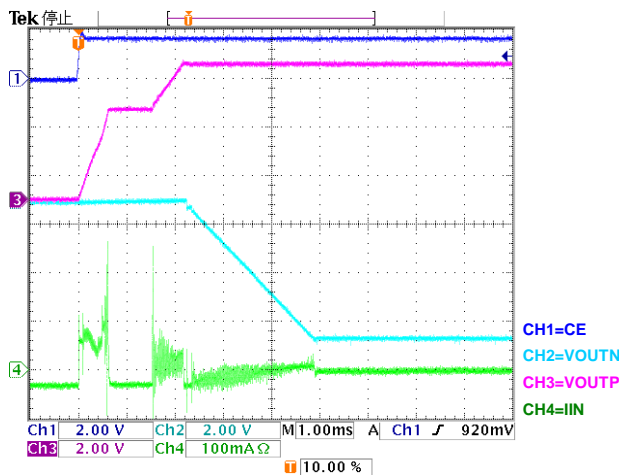

4) VOUTN Waveform with S-Wire Control

R1286Kx02A

($-4.9\text{ V} \leq V_{\text{OUTN}} \leq -2.4\text{ V}$, $I_{\text{OUTP}} = I_{\text{OUTN}} = 0\text{ mA}$)
($T_a = 25^\circ\text{C}$)

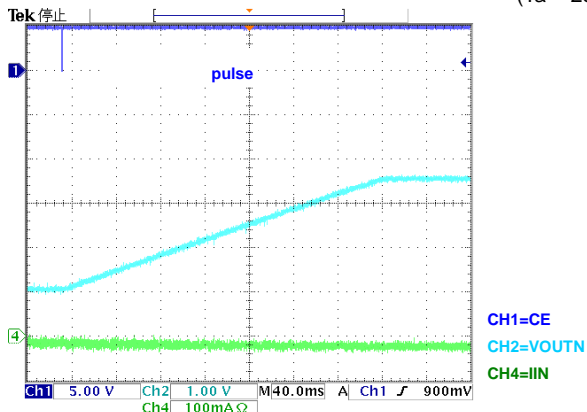

R1286Kx02A

($-2.4\text{ V} \leq V_{\text{OUTN}} \leq -4.9\text{ V}$, $I_{\text{OUTP}} = I_{\text{OUTN}} = 0\text{ mA}$)
($T_a = 25^\circ\text{C}$)

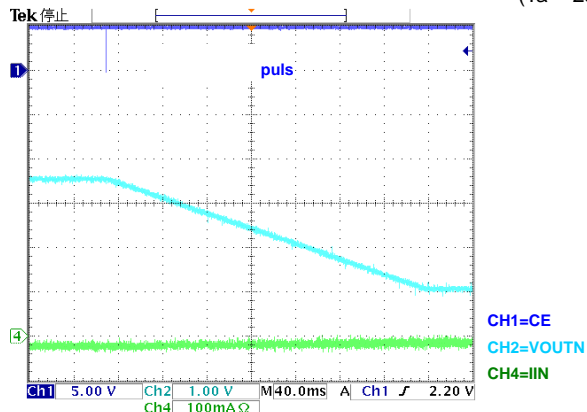

5) Load Transient Response

R1286KxxxX ($V_{\text{OUTP}} = 4.6\text{ V}$)

($T_a = 25^\circ\text{C}$)

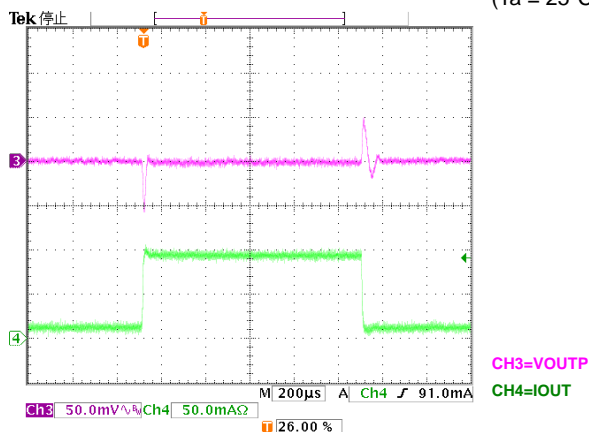

R1286KxxxX ($V_{\text{OUTN}} = -4.9\text{ V}$)

($T_a = 25^\circ\text{C}$)

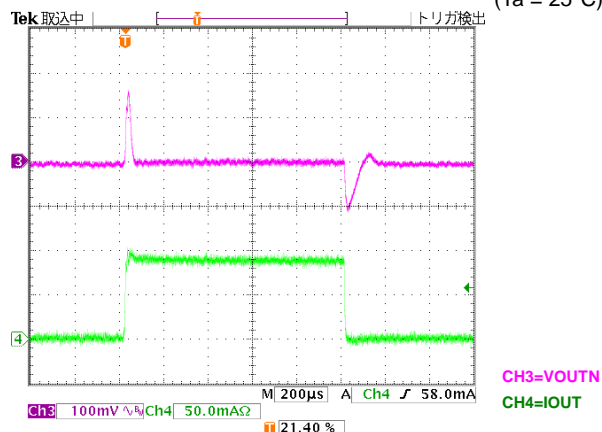

6) Line Transient Response

R1286KxxxX ($V_{\text{OUTP}} = 4.6\text{ V}$, $I_{\text{OUTP}} = 100\text{ mA}$)

($T_a = 25^\circ\text{C}$)

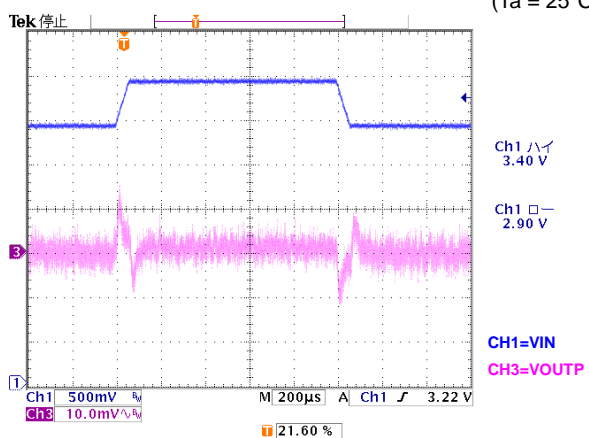

R1286KxxxX ($V_{\text{OUTN}} = -4.9\text{ V}$, $I_{\text{OUTN}} = 100\text{ mA}$)

($T_a = 25^\circ\text{C}$)

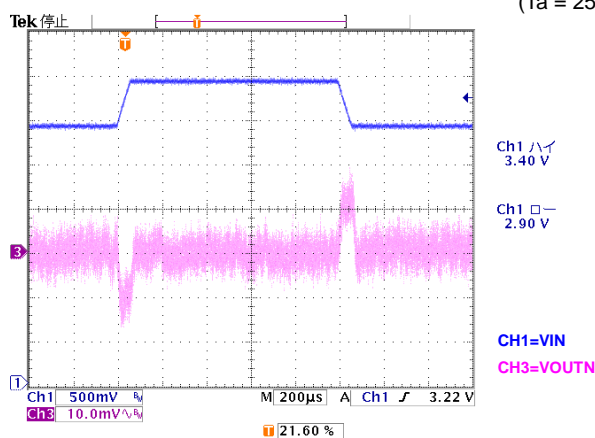

R1286K

NO.EA-283-191114

7) UVLO Voltage vs. Temperature

R1286KxxxX

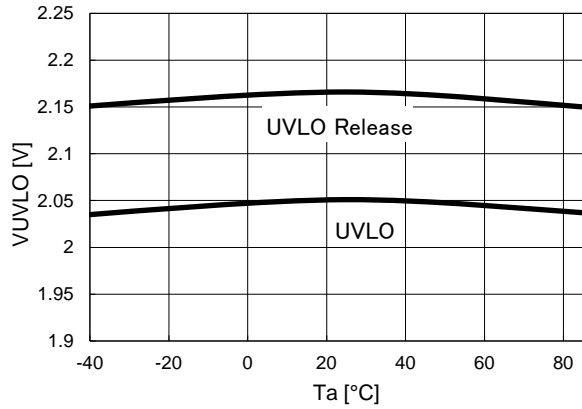

8) VOUTP Voltage vs. Temperature

R1286Kx02X

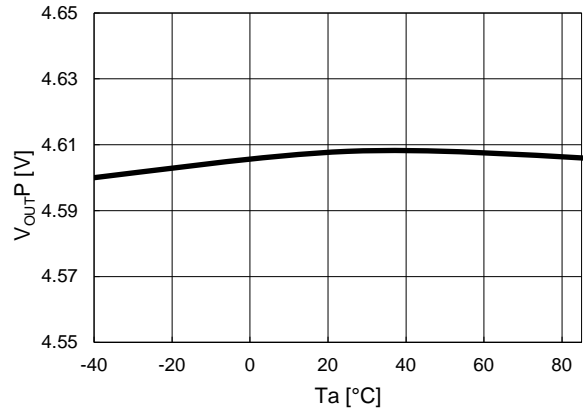

9) VOUTN Voltage vs. Temperature

R1286KxxxC

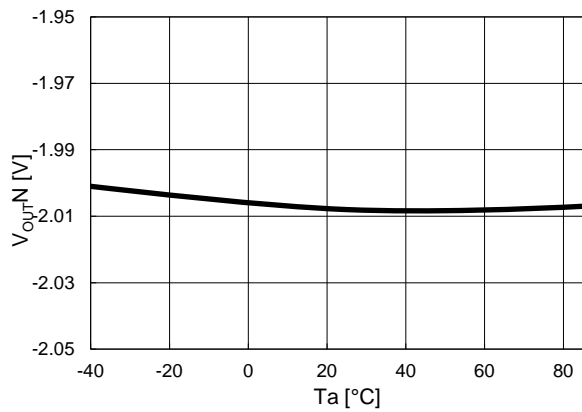

R1286KxxxX

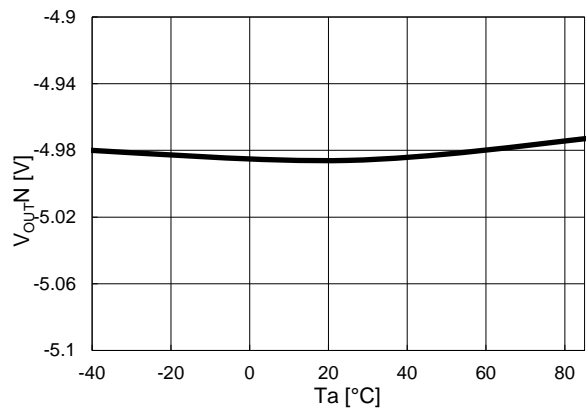

R1286KxxxG

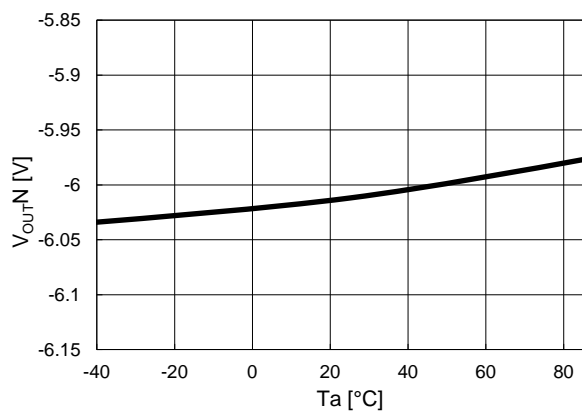

10) VFBN Voltage vs. Temperature
R1286K001B

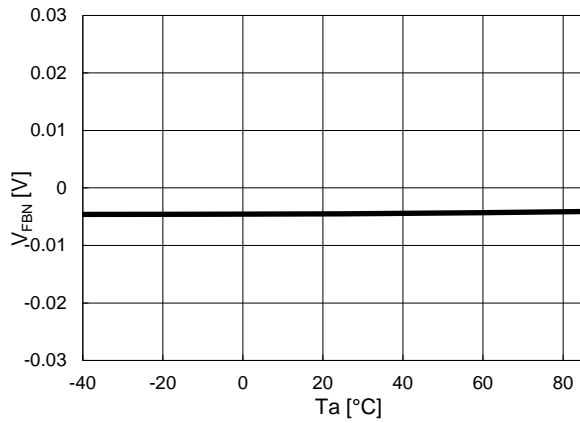

11) VREF Voltage vs. Temperature
R1286K001B

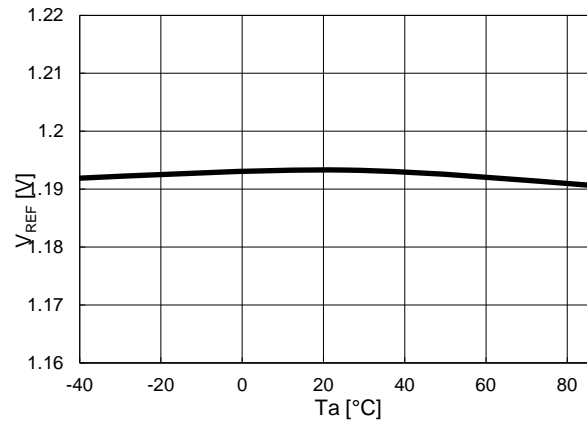

12) LXP Current Limit vs. Temperature
R1286KxxxX

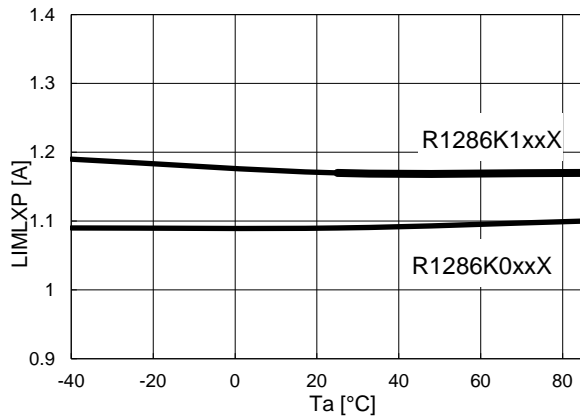

13) LXN Limit Current vs. Temperature
R1286KxxxX

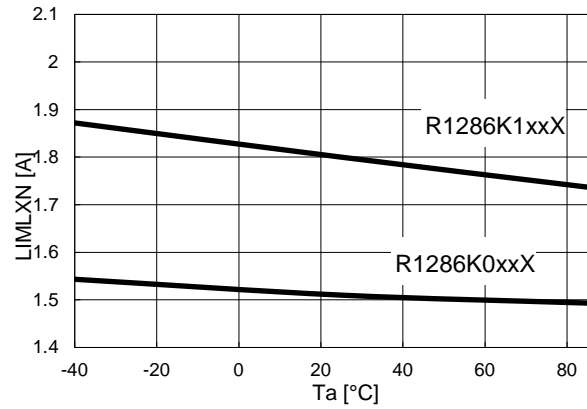

14) Oscillator Frequency vs. Temperature
R1286KxxxX

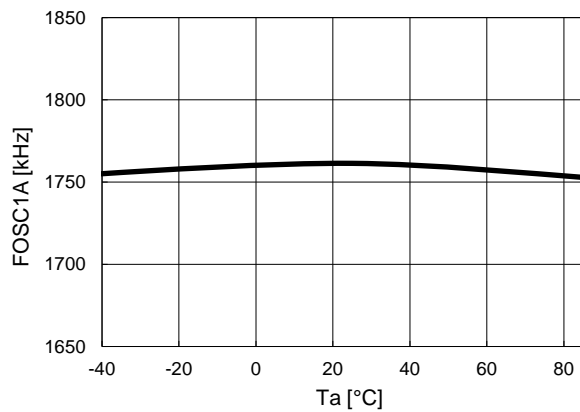

R1286K

NO.EA-283-191114

15) Maxduty1 vs. Temperature
R1286KxxxX

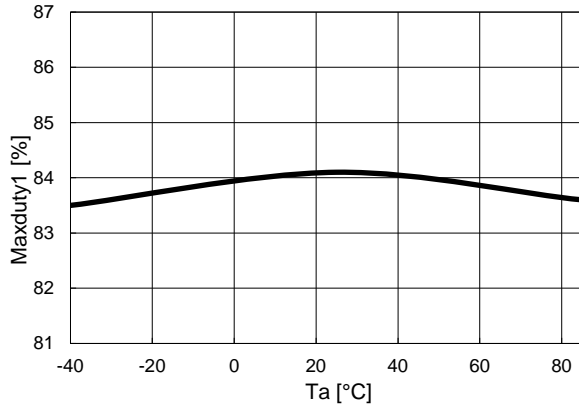

16) Maxduty2 vs. Temperature
R1286KxxxX

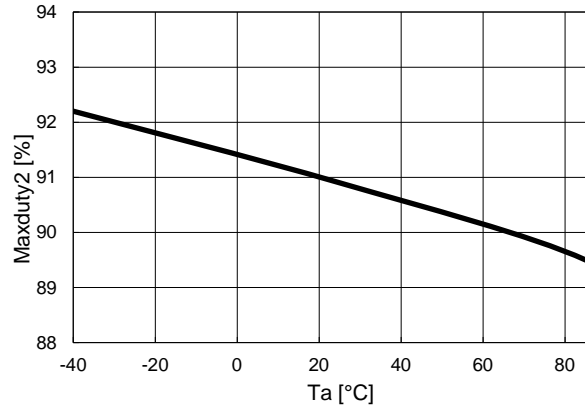

17) CH1 Soft-start Time vs. Temperature
R1286KxxxX

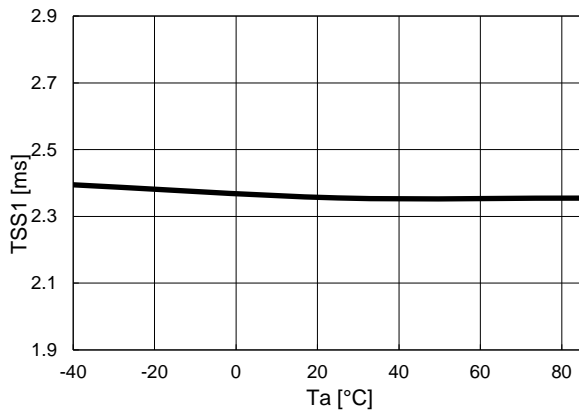

18) CH2 Soft-start Time vs. Temperature
R1286KxxxG

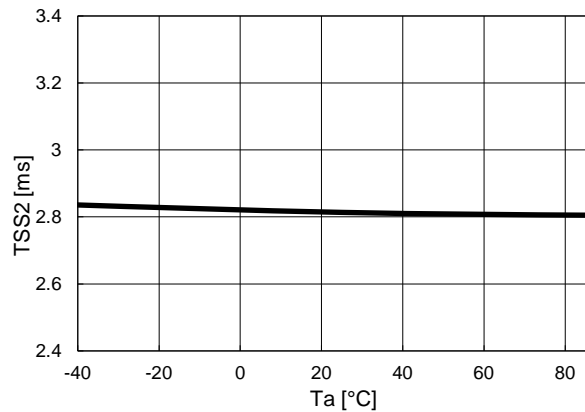

19) CH2 Soft-start Time vs. Temperature
R1286K001B

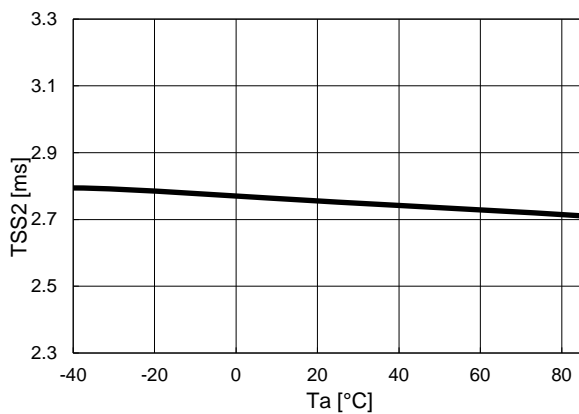

20) Delay Time for Protection vs. Temperature
R1286KxxxX

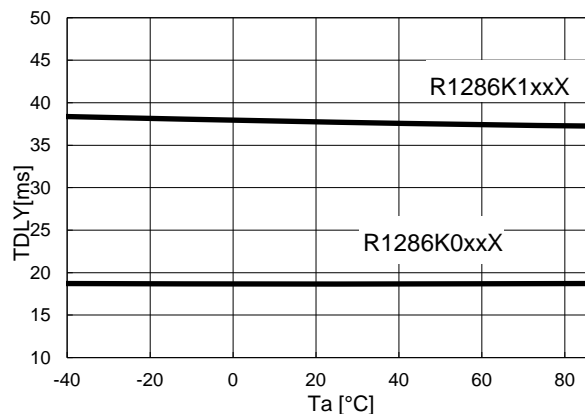

The power dissipation of the package is dependent on PCB material, layout, and environmental conditions. The following measurement conditions are based on JEDEC STD. 51-7.

Measurement Conditions

Item	Measurement Conditions
Environment	Mounting on Board (Wind Velocity = 0 m/s)
Board Material	Glass Cloth Epoxy Plastic (Four-Layer Board)
Board Dimensions	76.2 mm × 114.3 mm × 0.8 mm
Copper Ratio	Outer Layer (First Layer): Less than 95% of 50 mm Square Inner Layers (Second and Third Layers): Approx. 100% of 50 mm Square Outer Layer (Fourth Layer): Approx. 100% of 50 mm Square
Through-holes	φ 0.3 mm × 23 pcs

Measurement Result

(Ta = 25°C, Tjmax = 125°C)

Item	Measurement Result
Power Dissipation	3100 mW
Thermal Resistance (θja)	θja = 32°C/W
Thermal Characterization Parameter (ψjt)	ψjt = 8°C/W

θja: Junction-to-Ambient Thermal Resistance

ψjt: Junction-to-Top Thermal Characterization Parameter

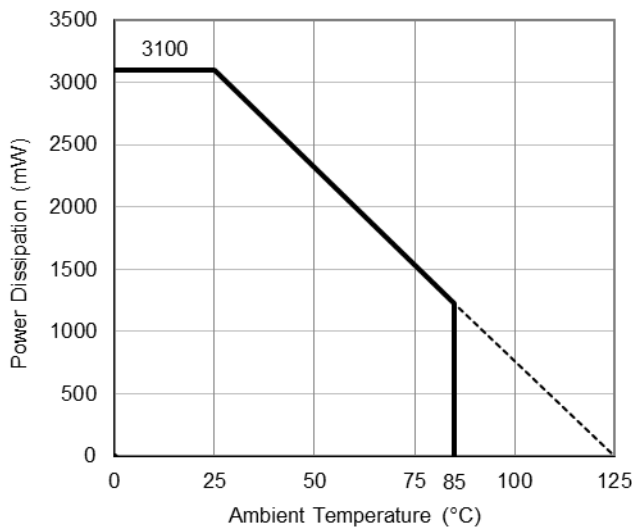

Power Dissipation vs. Ambient Temperature

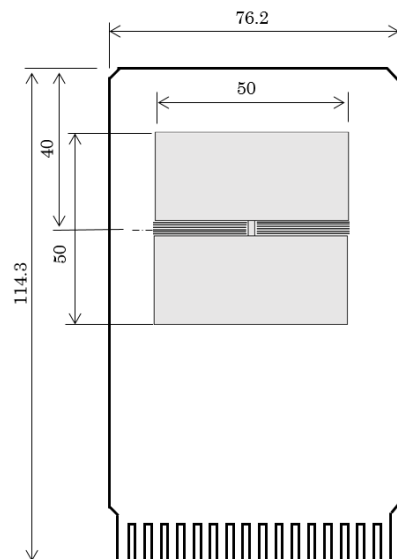

Measurement Board Pattern

PACKAGE DIMENSIONS

DFN(PLP)2730-12

DM-DFN(PNP)2730-12-JE-B

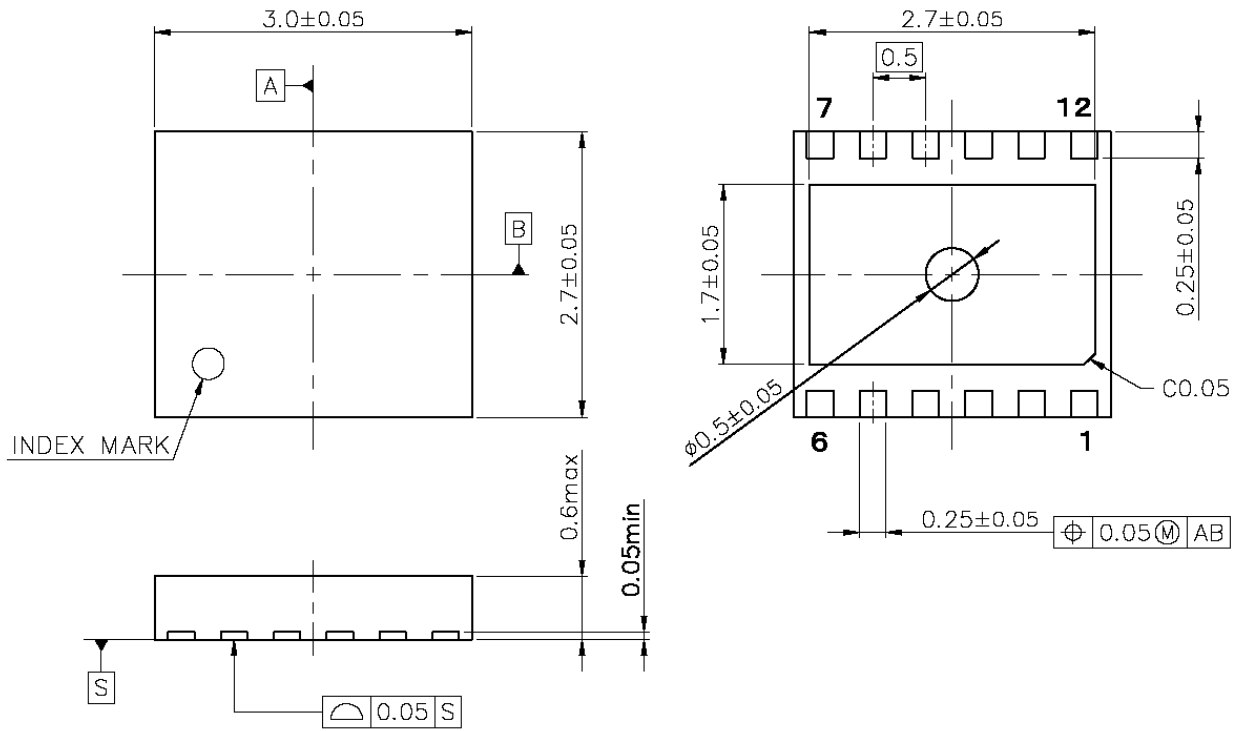

DFN(PLP)2730-12 Package Dimensions (Unit: mm)



1. The products and the product specifications described in this document are subject to change or discontinuation of production without notice for reasons such as improvement. Therefore, before deciding to use the products, please refer to Ricoh sales representatives for the latest information thereon.
2. The materials in this document may not be copied or otherwise reproduced in whole or in part without prior written consent of Ricoh.
3. Please be sure to take any necessary formalities under relevant laws or regulations before exporting or otherwise taking out of your country the products or the technical information described herein.
4. The technical information described in this document shows typical characteristics of and example application circuits for the products. The release of such information is not to be construed as a warranty of or a grant of license under Ricoh's or any third party's intellectual property rights or any other rights.
5. The products listed in this document are intended and designed for use as general electronic components in standard applications (office equipment, telecommunication equipment, measuring instruments, consumer electronic products, amusement equipment etc.). Those customers intending to use a product in an application requiring extreme quality and reliability, for example, in a highly specific application where the failure or misoperation of the product could result in human injury or death (aircraft, spacevehicle, nuclear reactor control system, traffic control system, automotive and transportation equipment, combustion equipment, safety devices, life support system etc.) should first contact us.
6. We are making our continuous effort to improve the quality and reliability of our products, but semiconductor products are likely to fail with certain probability. In order to prevent any injury to persons or damages to property resulting from such failure, customers should be careful enough to incorporate safety measures in their design, such as redundancy feature, fire containment feature and fail-safe feature. We do not assume any liability or responsibility for any loss or damage arising from misuse or inappropriate use of the products.
7. Anti-radiation design is not implemented in the products described in this document.
8. The X-ray exposure can influence functions and characteristics of the products. Confirm the product functions and characteristics in the evaluation stage.
9. WLCSP products should be used in light shielded environments. The light exposure can influence functions and characteristics of the products under operation or storage.
10. There can be variation in the marking when different AOI (Automated Optical Inspection) equipment is used. In the case of recognizing the marking characteristic with AOI, please contact Ricoh sales or our distributor before attempting to use AOI.
11. Please contact Ricoh sales representatives should you have any questions or comments concerning the products or the technical information.



Ricoh is committed to reducing the environmental loading materials in electrical devices with a view to contributing to the protection of human health and the environment.

Ricoh has been providing RoHS compliant products since April 1, 2006 and Halogen-free products since April 1, 2012.

RICOH RICOH ELECTRONIC DEVICES CO., LTD.

Official website

<https://www.e-devices.ricoh.co.jp/en/>

Contact us

<https://www.e-devices.ricoh.co.jp/en/support/>

