

* 1283Z (WLCSP-11-P2) is the discontinued product as of June, 2016.

RICOH

R1283x SERIES

2ch DC/DC for CCD & OLED

NO.EA-157-160224

OUTLINE

The R1283x 2ch DC/DC converter is designed for CCD & OLED Display power source. It contains a step up DC/DC converter and an inverting DC/DC converter to generate two required voltages by CCD & OLED Display. Step up DC/DC converter generates boosted output voltage up to 20V. Inverting DC/DC converter generates negative voltage up to V_{IN} voltage minus 20V independently. Start up sequence is internally made. Each of the R1283x series consists of an oscillator, a PWM control circuit, a voltage reference, error amplifiers, over current protection circuits, short protection circuits, an under voltage lockout circuit (UVLO), an Nch driver for boost operation, a Pch driver for inverting. A high efficiency boost and inverting DC/DC converter can be composed with external inductors, diodes, capacitors, and resistors.

FEATURES

- Operating Voltage 2.5V to 5.5V
- Step Up DC/DC (CH1)
 - Internal Nch MOSFET Driver ($R_{ON}=400m\Omega$ Typ.)
 - Adjustable V_{OUT} Up to 20V with external resistor
 - Internal Soft start function (Typ. 4.5ms)
 - Over Current Protection
 - Maximum Duty Cycle: 91%(Typ.)
- Inverting DC/DC (CH2)
 - Internal Pch MOSFET Driver ($R_{ON}=400m\Omega$ Typ.)
 - Adjustable V_{OUT} Up to $V_{DD}-20V$ with external resistor
 - Auto Discharge function for negative output
 - Internal Soft start function (Typ. 4.5ms)
 - Over Current Protection
 - Maximum Duty Cycle: 91%(Typ.)
- Short Protection with timer latch function (Typ. 50ms); Short condition for either or both two outputs makes all output drivers off and latches./ If the maximum duty cycle continues for a certain time, these output drivers will be turned off.
 - CE with start up sequence function
 - CH1→CH2 (R1283K001x) / CH2→CH1(R1283K002x) Selectable
 - UVLO function
 - Operating Frequency Selection300kHz / 700kHz / 1400kHz
- Packages DFN(PLP)2730-12, WLCSP-11-P2

APPLICATION

- Fixed voltage power supply for portable equipment
 - Fixed voltage power supply for CCD, OLED, LCD
-

R1283x

BLOCK DIAGRAM

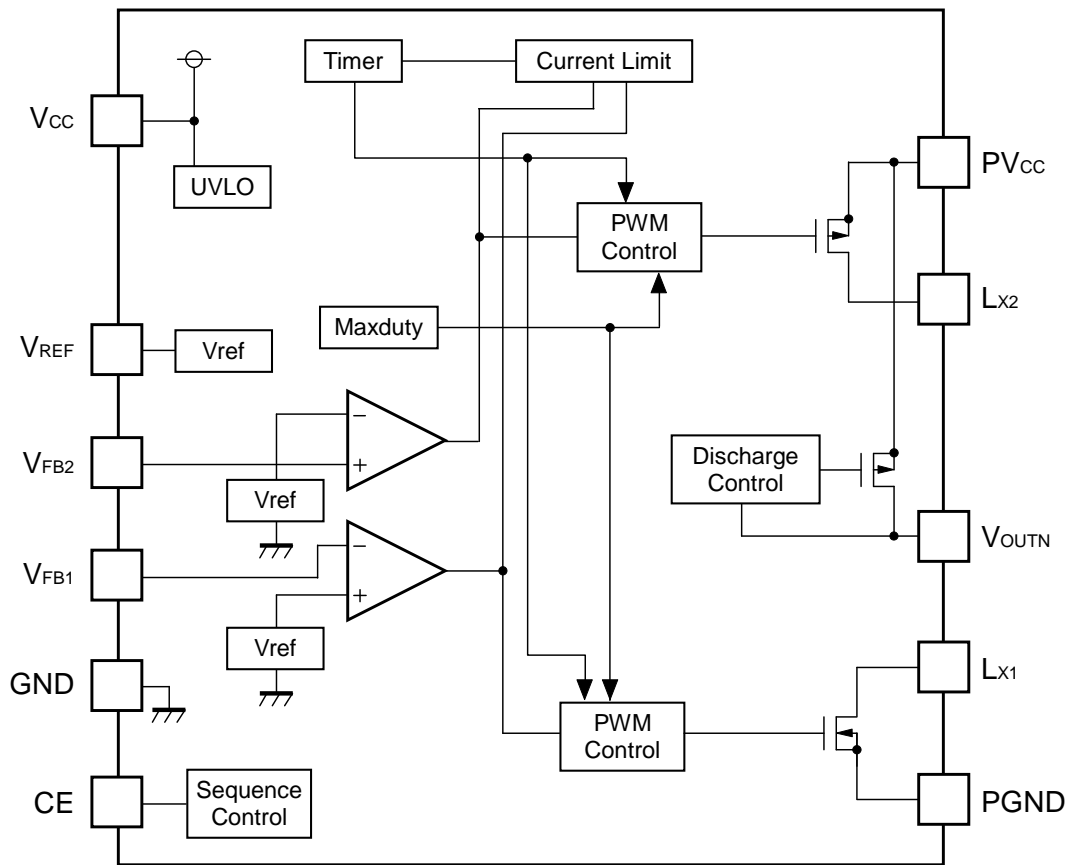

SELECTION GUIDE

The start-up sequence, oscillator frequency, and the package for the ICs can be selected at the user's request.

Product Name	Package	Quantity per Reel	Pb Free	Halogen Free
R1283Z00x*-E2-F	WLCSP-11-P2	4,000 pcs	Yes	Yes
R1283K00x*-TR	DFN(PLP)2730-12	5,000 pcs	Yes	Yes

x : The start-up sequence can be designated.
(1) Step-up → Inverting
(2) Inverting → Step-up

* : The oscillator frequency is the option as follows.
(A) 300kHz (A Version for 1283Z packaged in WLCSP-11-P2 is not available)
(B) 700kHz
(C) 1400kHz

R1283x

PIN CONFIGURATIONS

• WLCSP-11-P2

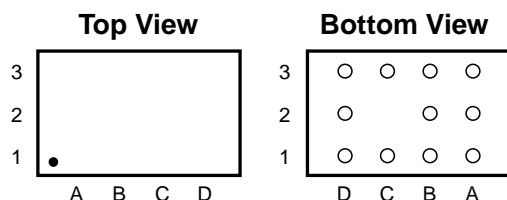

• DFN(PLP)2730-12

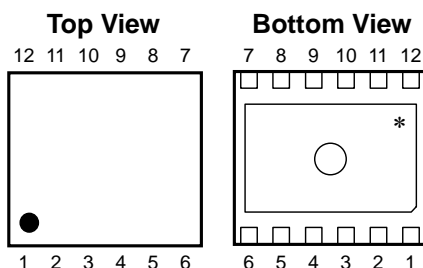

PIN DESCRIPTIONS

• WLCSP-11-P2

Pin No	Symbol	Pin Description
A1	PGND	Power GND pin
A2	V_{FB1}	Feedback pin for Step up DC/DC
A3	L_{X1}	Switching pin for Step up DC/DC
B1	PV_{CC}	Power Input pin
B2	CE	Chip Enable pin for the R1283
B3	L_{X2}	Switching pin for Inverting DC/DC
C1	GND	Analog GND pin
C3	V_{OUTN}	Discharge pin for Negative output
D1	V_{CC}	Analog power source Input pin
D2	V_{REF}	Reference Voltage Output pin
D3	V_{FB2}	Feedback pin for Inverting DC/DC

• DFN(PLP)2730-12

Pin No	Symbol	Pin Description
1	NC	No Connect
2	L_{X1}	Switching pin for Step up DC/DC
3	L_{X2}	Switching pin for Inverting DC/DC
4	V_{OUTN}	Discharge pin for Negative Output
5	CE	Chip Enable pin for the R1283
6	V_{FB2}	Feedback pin for Inverting DC/DC
7	V_{REF}	Reference Voltage Output pin
8	V_{CC}	Analog power source Input pin
9	V_{FB1}	Feedback pin for Step up DC/DC
10	GND	Analog GND pin
11	PV_{CC}	Power Input pin
12	PGND	Power GND pin

*) Tab is GND level. (They are connected to the reverse side of this IC.)

The tab is better to be connected to the GND, but leaving it open is also acceptable.

ABSOLUTE MAXIMUM RATINGS

(GND/PGND=0V)

Symbol	Item	Rating	Unit
V _{CC}	V _{CC} / PV _{CC} pin Voltage	6.5	V
V _{DTC}	V _{FB1} pin Voltage	-0.3 to V _{CC} +0.3	V
V _{FB}	V _{FB2} pin Voltage	-0.7(*1) to V _{CC} +0.3	V
V _{CE}	CE pin Voltage	-0.3 to V _{CC} +0.3	V
V _{REF}	V _{REF} pin Voltage	-0.7(*1) to V _{CC} +0.3	V
V _{LX1}	LX1 pin Voltage	-0.3 to 24	V
I _{LX1}	LX1 pin Current	Internally Limited	A
V _{LX2}	LX2 pin Voltage	V _{CC} -24 to V _{CC} +0.3	V
I _{LX2}	LX2 pin Current	Internally Limited	A
V _{NFB}	V _{OUTN} pin Voltage	V _{CC} -24 to V _{CC} +0.3	V
P _D	Power Dissipation (WLCSP-11-P2) (*2)	1000	mW
	Power Dissipation (DFN(PLP)2730-12) (*2)	1000	
T _{opt}	Operating Temperature Range	-40 to 85	°C
T _{stg}	Storage Temperature Range	-55 to 125	°C

*1) In case the voltage range is from -0.7V to -0.3V, permissible current is 10mA or less.

*2) For Power Dissipation, please refer to PACKAGE INFORMATION.

ABSOLUTE MAXIMUM RATINGS

Electronic and mechanical stress momentarily exceeded absolute maximum ratings may cause the permanent damages and may degrade the life time and safety for both device and system using the device in the field.

The functional operation at or over these absolute maximum ratings is not assured.

RECOMMENDED OPERATING CONDITIONS (ELECTRICAL CHARACTERISTICS)

All of electronic equipment should be designed that the mounted semiconductor devices operate within the recommended operating conditions. The semiconductor devices cannot operate normally over the recommended operating conditions, even if when they are used over such conditions by momentary electronic noise or surge. And the semiconductor devices may receive serious damage when they continue to operate over the recommended operating conditions.

R1283x

ELECTRICAL CHARACTERISTICS

• R1283x

T_{opt}=25°C

Symbol	Item	Conditions	Min.	Typ.	Max.	Unit.
V _{CC}	Operating Input Voltage		2.5		5.5	V
I _{CC1}	V _{CC} Consumption Current (Switching)	V _{CC} =5.5V, F _{FREQ} =300kHz		2.0		mA
		V _{CC} =5.5V, F _{FREQ} =700kHz		4.0		mA
		V _{CC} =5.5V, F _{FREQ} =1400kHz		8.0		mA
I _{CC2}	V _{CC} Consumption Current (At no switching)	V _{CC} =5.5V, F _{FREQ} =300kHz		250		μA
		V _{CC} =5.5V, F _{FREQ} =700kHz		300		μA
		V _{CC} =5.5V, F _{FREQ} =1400kHz		350		μA
I _{standby}	Standby Current	V _{CC} =5.5V		0.1	3	μA
V _{UVLO1}	UVLO Detect Voltage	Falling	2.05	2.15	2.25	V
V _{UVLO2}	UVLO Released Voltage	Rising		V _{UVLO1} +0.16	2.48	V
V _{REF}	V _{REF} Voltage Tolerance	V _{CC} =3.3V	1.172 +V _{FB2}	1.2 +V _{FB2}	1.228 +V _{FB2}	V
ΔV _{REF} /ΔT _{opt}	V _{REF} Voltage Temperature Coefficient	V _{CC} =3.3V, -40°C≤T _{opt} ≤85°C		±150		ppm/°C
ΔV _{REF} /ΔV _{CC}	V _{REF} Line Regulation	2.5V≤V _{CC} ≤5.5V		5		mV
ΔV _{REF} /ΔI _{OUT}	V _{REF} Load Regulation	V _{CC} =3.3V, 0.1mA≤I _{OUT} ≤2mA		5		mV
I _{LIMREF}	V _{REF} Short Current Limit	V _{CC} =3.3V, V _{REF} =0V		15		mA
V _{FB1}	V _{FB1} Voltage Tolerance	V _{CC} =3.3V	0.985	1.0	1.015	V
ΔV _{FB1} /ΔT _{opt}	V _{FB1} Voltage Temperature Coefficient	V _{CC} =3.3V, -40°C≤T _{opt} ≤85°C		±150		ppm/°C
I _{FB1}	V _{FB1} Input Current	V _{CC} =5.5V, V _{FB1} =0V or 5.5V	-0.1		0.1	μA
V _{FB2}	V _{FB2} Voltage Tolerance	V _{CC} =3.3V	-25	0	25	mV
I _{FB2}	V _{FB2} Input Current	V _{CC} =5.5V, V _{FB2} =0V or 5.5V	-0.1		0.1	μA
f _{osc}	Oscillator Frequency	V _{CC} =3.3V	240	300	360	kHz
		V _{CC} =3.3V	600	700	800	kHz
		V _{CC} =3.3V	1200	1400	1600	kHz
Maxduty1	CH1 Max. Duty Cycle	V _{CC} =3.3V	86	91		%
Maxduty2	CH2 Max. Duty Cycle	V _{CC} =3.3V	86	91		%
t _{SS1}	CH1 Soft-start Time	V _{CC} =3.3V, V _{FB1} =0.9V		4.5		ms
t _{SS2}	CH2 Soft-start Time	V _{CC} =3.3V, V _{FB2} =0.12V		4.5		ms
t _{DLY}	Delay Time for Protection	V _{CC} =3.3V	20	50		ms
R _{LX1}	L _{X1} ON Resistance	V _{CC} =3.3V		400		mΩ
I _{OFFLX1}	L _{X1} Leakage Current	V _{CC} =5.5V, V _{LX1} =20V			5	μA
I _{LIMLX1}	L _{X1} Current limit	V _{CC} =3.3V	1.0	1.5		A
R _{LX2}	L _{X2} ON Resistance	V _{CC} =3.3V		400		mΩ
I _{OFFLX2}	L _{X2} Leakage Current	V _{CC} =5.5V, V _{LX2} =-14.5V			5	μA
I _{LIMLX2}	L _{X2} Current limit	V _{CC} =3.3V	1.0	1.5		A
R _{VOUTN}	V _{OUTN} Discharge Resistance	V _{CC} =3.3V, V _{OUTN} =-0.3V		10	25	Ω
V _{CEL}	CE "L" Input Voltage	V _{CC} =2.5V			0.3	V
V _{CEH}	CE "H" Input Voltage	V _{CC} =5.5V	1.5			V
I _{CEL}	CE "L" Input Current	V _{CC} =5.5V	-1.0		1.0	μA
I _{CEH}	CE "H" Input Current	V _{CC} =5.5V	-1.0		1.0	μA

TYPICAL APPLICATION

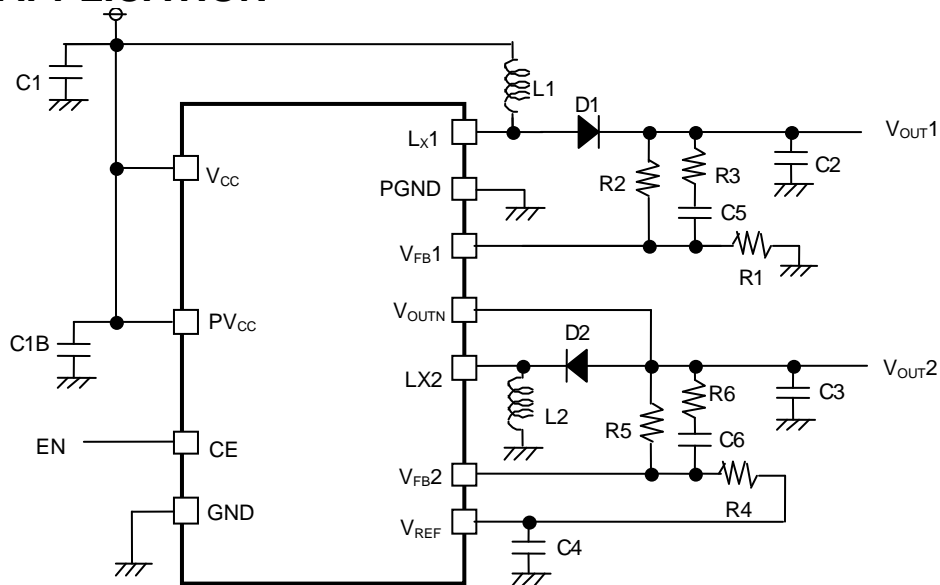

• Pin Connection

Externally short V_{CC} pin to PV_{CC} pin. Externally short GND pin to PGND pin.

• Step-up DC/DC converter output voltage setting

The output voltage V_{OUT1} of the step-up DC/DC converter is controlled with maintaining the V_{FB1} as 1.0V.

V_{OUT1} can be set with adjusting the values of R1 and R2 as in the next formula. V_{OUT1} can be set equal or less than 20V.

$$V_{OUT1} = V_{FB1} \times (R1+R2) / R1$$

• Inverting DC/DC converter output voltage setting

The output voltage V_{OUT2} of the inverting DC/DC converter is controlled with maintaining the V_{FB2} as 0V.

V_{OUT2} can be set with adjusting the values of R4 and R5 as in the next formula.

$$V_{OUT2} = V_{FB2} - (V_{REF}-V_{FB2}) \times R5 / R4$$

• Auto Discharge Function

When CE level turns from "H" to "L" level, the R1283x goes into standby mode and switching of the outputs of L_{X1} and L_{X2} will stop. Then discharge T_r between V_{OUT2} and V_{CC} turns on and discharges the negative output voltage. When the negative output voltage is discharged to 0V, the T_r turns off and the negative output will be Hi-Z.

When the Auto discharge function is unnecessary, V_{OUTN} connect to V_{CC} or make be Hi-Z.

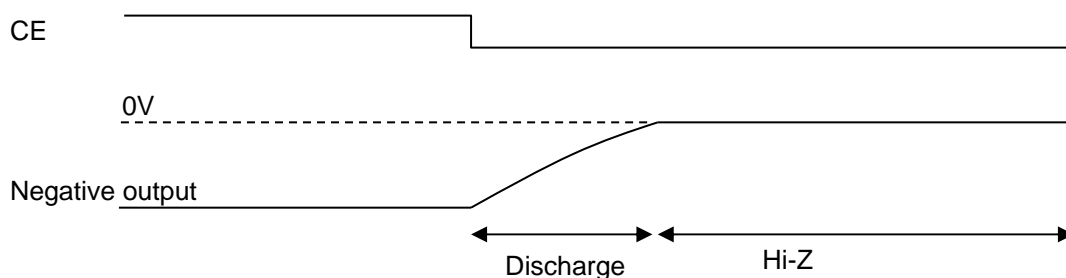

R1283x

• Start up Sequence (R1283x001x)

When CE level turns from "L" to "H" level, the softstart of CH1 starts the operation. After detecting output voltage of CH1(V_{OUT1}) as the nominal level, the soft start of CH2 starts the operation.

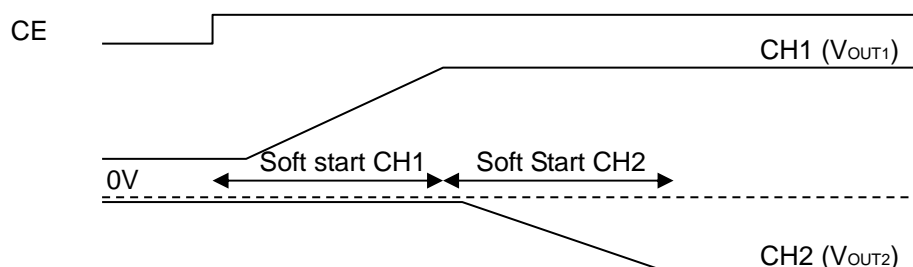

• Start up Sequence (R1283x002x)

When CE level turns from "L" to "H" level, the softstart of CH2 starts the operation. After detecting output voltage of CH2(V_{OUT2}) as the nominal level, the soft start of CH1 starts the operation.

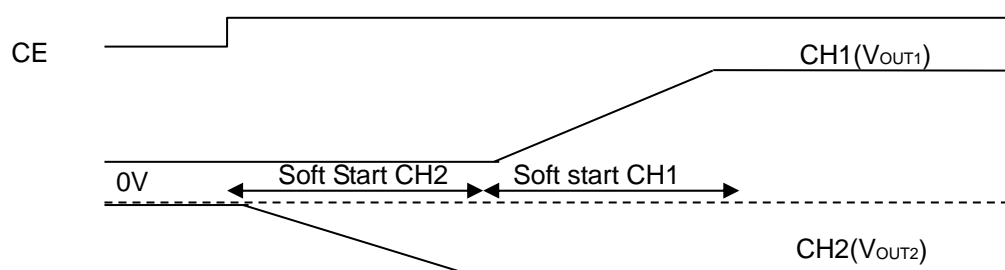

• Short protection circuit timer

In case that the voltage of V_{FB1} drops, the error amplifier of CH1 outputs "H". In case that the voltage of V_{FB2} rises, the error amplifier of CH2 outputs "L". The built-in short protection circuit makes the internal timer operate with detecting the output of the error amplifier of CH1 as "H", or the output of the error amplifier of CH2 as "L". After the setting time will pass, the switching of LX1 and LX2 will stop.

To release the latch operation, make the V_{CC} set equal or less than UVLO level and restart or set the CE pin as "L" and make it "H" again.

During the softstart operation of CH1 and CH2, the timer operates independently from the outputs of the error amplifiers. Therefore, even if the softstart cannot finish correctly because of the short circuit, the protection timer function will be able to work correctly.

• Phase Compensation

DC/DC converter's phase may lose 180 degree by external components of L and C and load current. Because of this, the phase margin of the system will be less and the stability will be worse. Therefore, the phase must be gained.

A pole will be formed by external components, L and C.

$$F_{\text{pole}} \sim 1 / \{2 \times \pi \times \sqrt{L1 \times C2}\} \quad (\text{CH1})$$

$$F_{\text{pole}} \sim 1 / \{2 \times \pi \times \sqrt{L2 \times C3}\} \quad (\text{CH2})$$

Zero will be formed with R2, C5, R5, and C6.

$$F_{zero} \sim 1/(2 \times \pi \times R2 \times C5) \quad (\text{CH1})$$

$$F_{zero} \sim 1/(2 \times \pi \times R5 \times C6) \quad (\text{CH2})$$

Set the cut-off frequency of the Zero close to the cut off frequency of the pole by L and C.

● **To reduce the noise of Feedback voltage**

If the noise of the system is large, the output noise affects the feedback and the operation may be unstable. In that case, resistor values, R1, R2, R4, and R5 should be set lower and make the noise into the feedback pin reduce. Another method is set R3 and R6 . The appropriate value range is from 1kΩ to 5kΩ.

- Set a ceramic 1μF or more capacitor as C1B between V_{CC} pin and GND. Set another 4.7μF or more capacitor between PV_{CC} and GND as C1.
- Set a ceramic 1μF or more capacitor between V_{OUT1} and GND, and between V_{OUT2} and GND for each as C2 and C3. Recommendation value range is from 4.7μF to 22μF.
- Set a ceramic capacitor between VREF and GND as C4. Recommendation value range is from 0.1μF to 2.2μF.

Operation of Step-up DC/DC Converter and Output Current

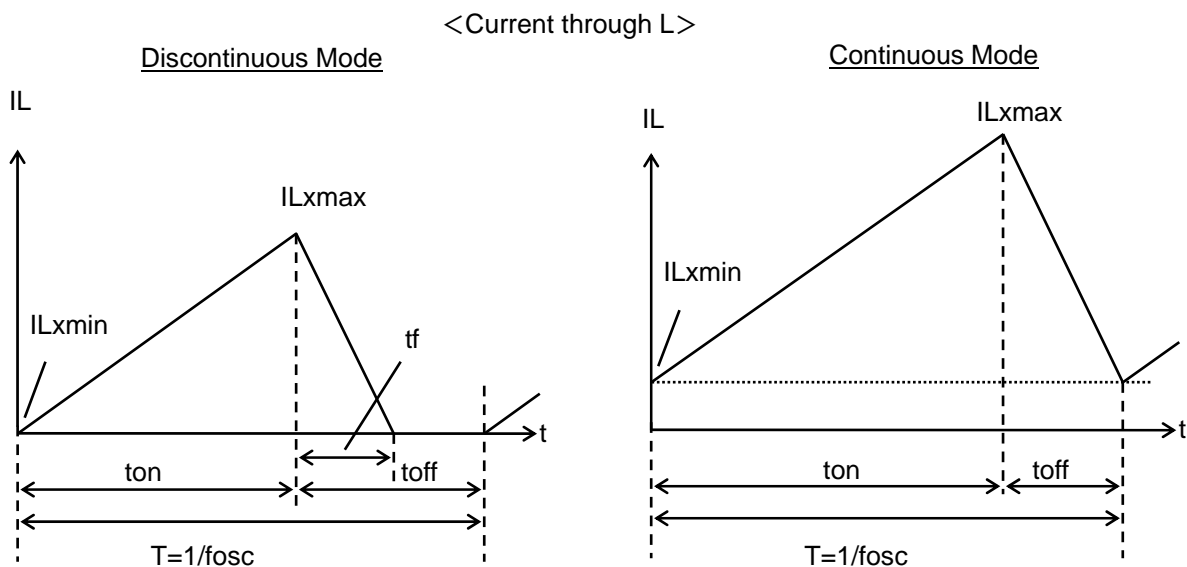
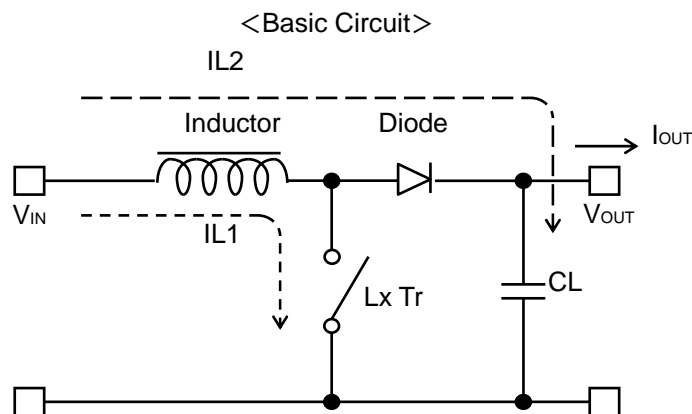

R1283x

There are two operation modes for the PWM control step-up switching regulator, that is the continuous mode and the discontinuous mode.

When the Lx Tr. is on, the voltage for the inductor L will be V_{IN} . The inductor current ($IL1$) will be;

$$IL1 = V_{IN} \times t_{on} / L \dots\dots\dots \text{Formula1}$$

When the Lx transistor turns off, power will supply continuously. The inductor current at off ($IL2$) will be;

$$IL2 = (V_{OUT} - V_{IN}) \times t_f / L \dots\dots\dots \text{Formula2}$$

In terms of the PWM control, when the $t_f=t_{off}$, the inductor current will be continuous, the operation of the switching regulator will be continuous mode.

In the continuous mode, the current variation of $IL1$ and $IL2$ are same, therefore

$$V_{IN} \times t_{on} / L = (V_{OUT} - V_{IN}) \times t_{off} / L \dots\dots\dots \text{Formula3}$$

In the continuous mode, the duty cycle will be

$$\text{DUTY} = t_{on} / (t_{on} + t_{off}) = (V_{OUT} - V_{IN}) / V_{OUT} \dots\dots\dots \text{Formula4}$$

If the input power equals to output power,

$$I_{OUT} = V_{IN}^2 \times t_{on} / (2 \times L \times V_{OUT}) \dots\dots\dots \text{Formula5}$$

When I_{OUT} becomes more than Formula5, it will be continuous mode.

In this moment, the peak current, IL_{xmax} flowing through the inductor is described as follows:

$$IL_{xmax} = I_{OUT} \times V_{OUT} / V_{IN} + V_{IN} \times t_{on} / (2 \times L) \dots\dots\dots \text{Formula6}$$

$$IL_{xmax} = I_{OUT} \times V_{OUT} / V_{IN} + V_{IN} \times T \times (V_{OUT} - V_{IN}) / (2 \times L \times V_{OUT}) \dots\dots\dots \text{Formula7}$$

Therefore, peak current is more than I_{OUT} . Considering the value of IL_{xmax} , the condition of input and output, and external components should be selected.

The explanation above is based on the ideal calculation, and the loss caused by Lx switch and external components is not included.

The actual maximum output current is between 50% and 80% of the calculation.

Especially, when the IL is large, or V_{IN} is low, the loss of V_{IN} is generated with on resistance of the switch. As for V_{OUT} , V_F (as much as 0.3V) of the diode should be considered.

Operation of Inverting DC/DC Converter and Output Current

<Basic Circuit>

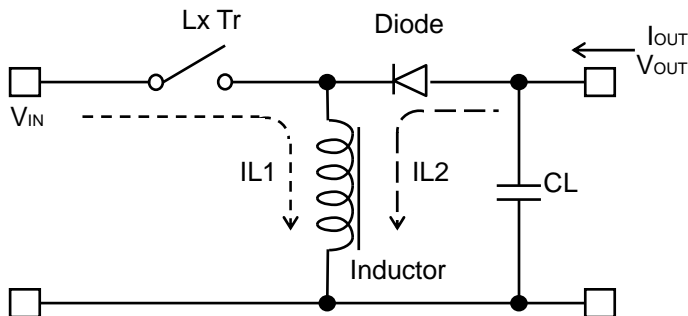

<Current through L>

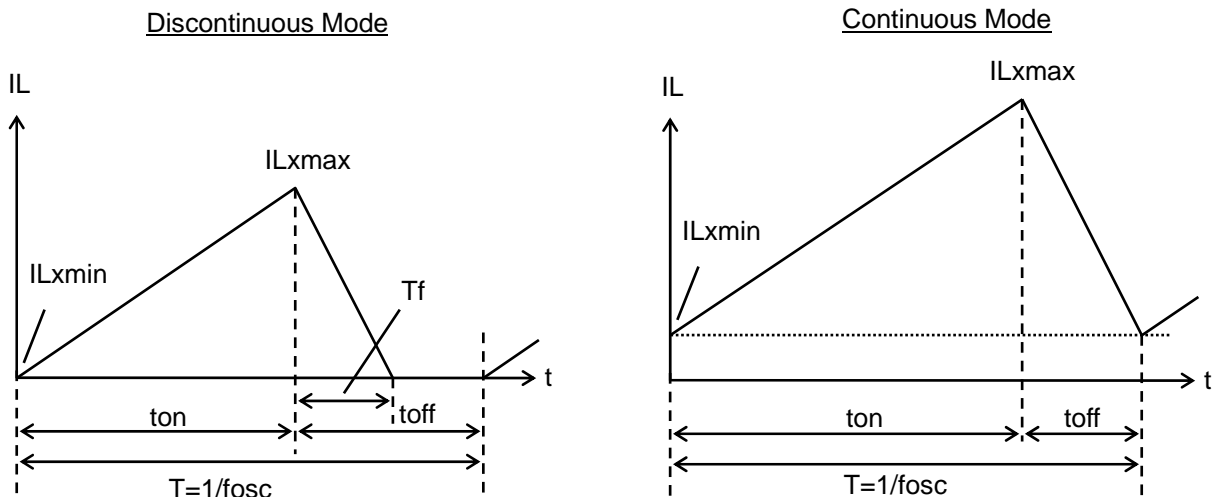

There are also two operation modes for the PWM control inverting switching regulator, that is the continuous mode and the discontinuous mode.

When the Lx Tr. is on, the voltage for the inductor L will be V_{IN} . The inductor current ($IL1$) will be;

$$IL1 = V_{IN} \times t_{on} / L \dots \dots \dots \text{Formula8}$$

Inverting circuit saves energy during on time of Lx Tr, and supplies the energy to output during off time, output voltage opposed to input voltage is obtained. The inductor current at off ($IL2$) will be;

$$IL2 = |V_{OUT}| \times t_f / L \dots \dots \dots \text{Formula9}$$

In terms of the PWM control, when the $t_f=t_{off}$, the inductor current will be continuous, the operation of the switching regulator will be continuous mode.

In the continuous mode, the current variation of $IL1$ and $IL2$ are same, therefore

R1283x

$$V_{IN} \times t_{on} / L = |V_{OUT}| \times t_{off} / L \dots\dots\dots \text{Formula10}$$

In the continuous mode, the duty cycle will be:

$$\text{DUTY} = t_{on} / (t_{on} + t_{off}) = |V_{OUT}| / (|V_{OUT}| + V_{IN}) \dots\dots\dots \text{Formula11}$$

If the input power equals to output power,

$$I_{OUT} = V_{IN}^2 \times t_{on} / (2 \times L \times |V_{OUT}|) \dots\dots\dots \text{Formula12}$$

When I_{OUT} becomes more than Formula12, it will be continuous mode.

In this moment, the peak current, I_{Lxmax} flowing through the inductor is described as follows:

$$I_{Lxmax} = I_{OUT} \times |V_{OUT}| / V_{IN} + V_{IN} \times t_{on} / (2 \times L) \dots\dots\dots \text{Formula13}$$

$$I_{Lxmax} = I_{OUT} \times |V_{OUT}| / V_{IN} + V_{IN} \times |V_{OUT}| \times T / \{ 2 \times L \times (|V_{OUT}| + V_{IN}) \} \dots\dots\dots \text{Formula14}$$

Therefore, peak current is more than I_{OUT} . Considering the value of I_{Lxmax} , the condition of input and output, and external components should be selected.

The explanation above is based on the ideal calculation, and the loss caused by L_x switch and external components is not included.

The actual maximum output current is between 50% and 80% of the calculation.

Especially, when the I_L is large, or V_{IN} is low, the loss of V_{IN} is generated with on resistance of the switch. As for V_{OUT} , V_F (as much as 0.3V) of the diode should be considered.

TYPICAL CHARACTERISTICS

1) Output Voltage VS. Output Current

R1283x001A

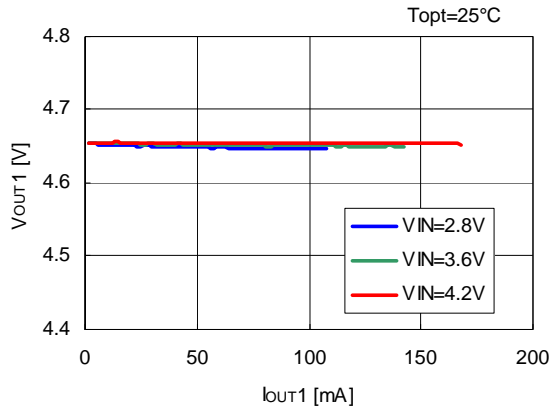

R1283x001A

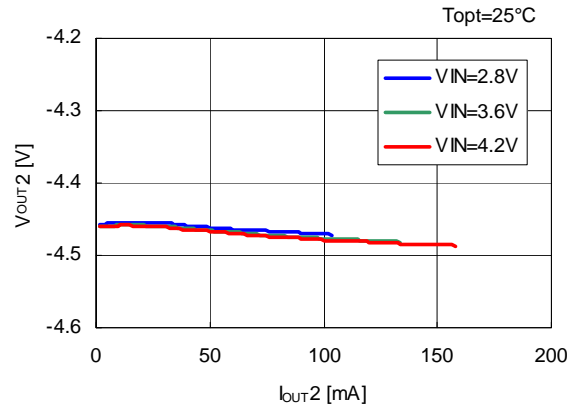

R1283x001A

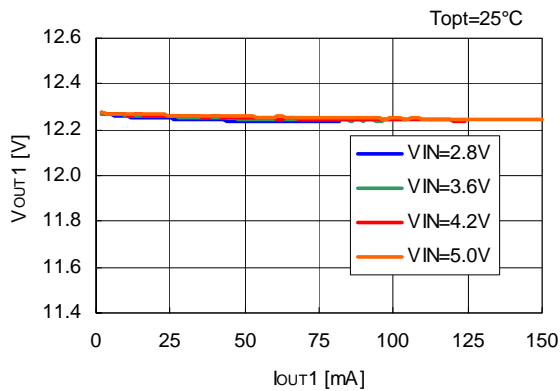

R1283x001A

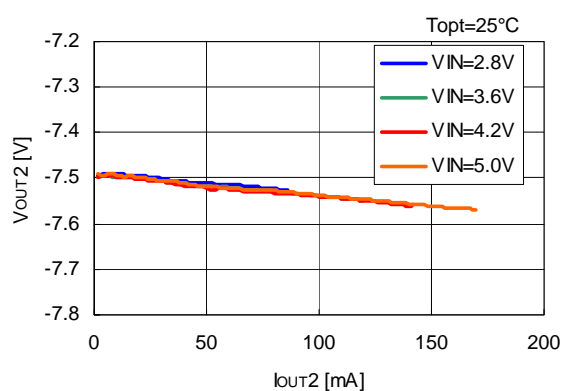

R1283x001B

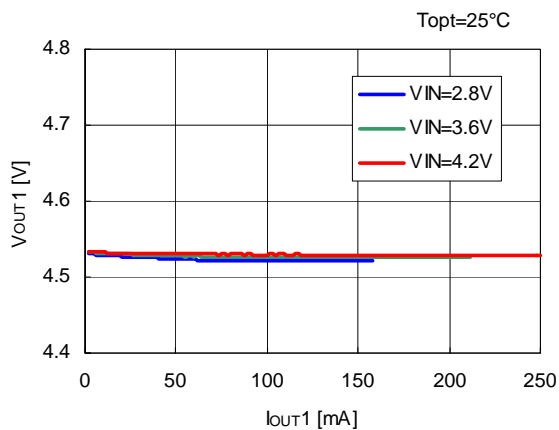

R1283x001B

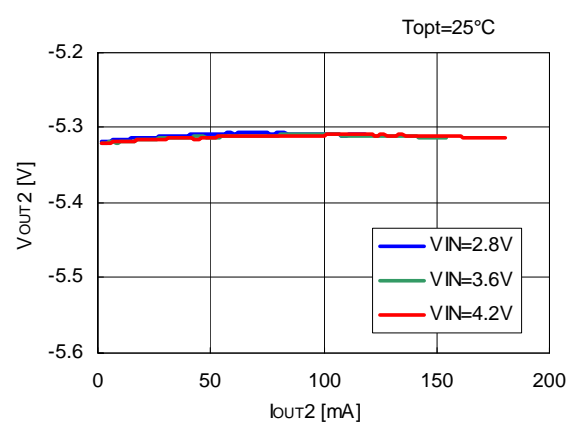

R1283x

R1283x001B

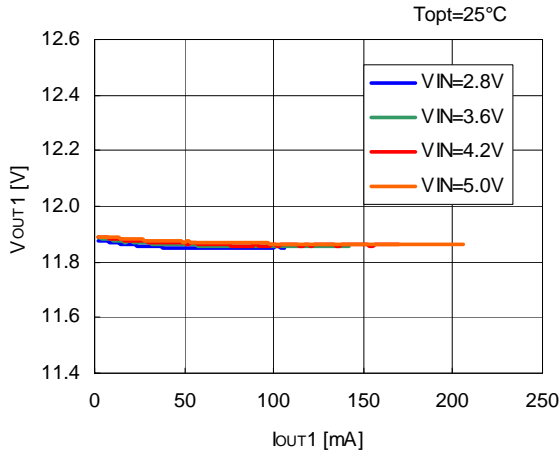

R1283x001B

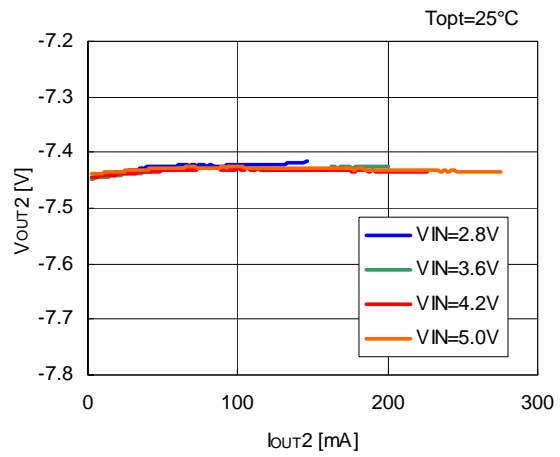

R1283x001C

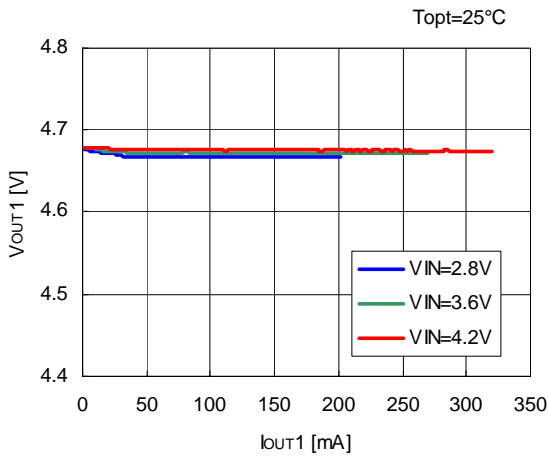

R1283x001C

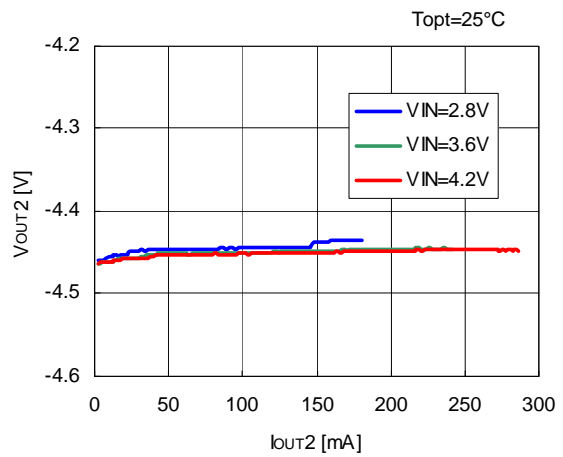

R1283x001C

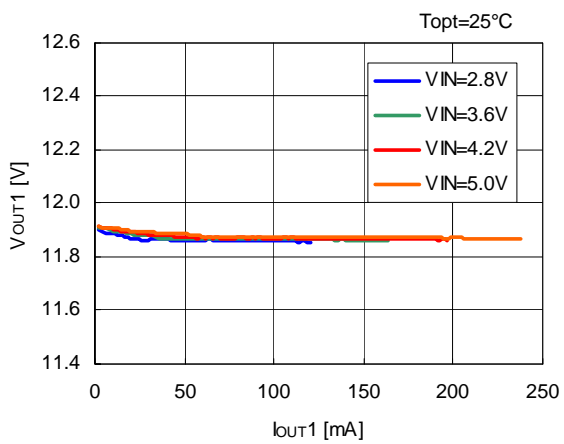

R1283x001C

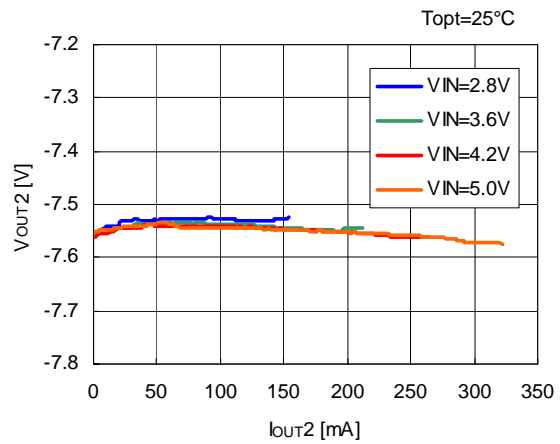

2) Efficiency vs. Output Current

R1283x001A

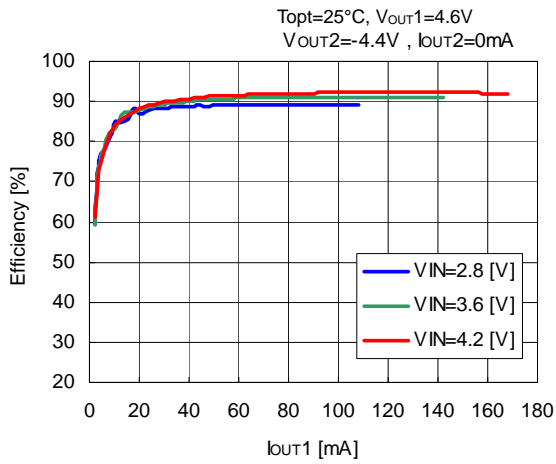

R1283x001A

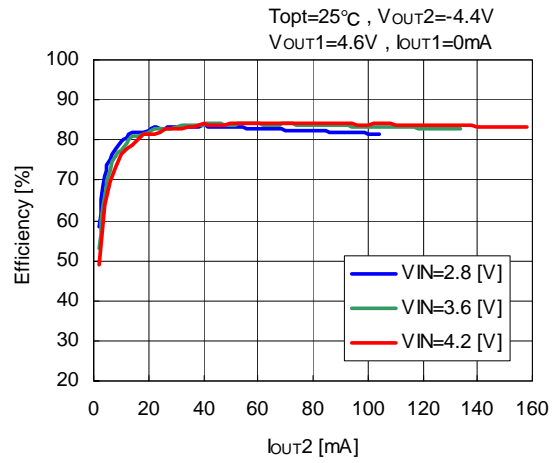

R1283x001A

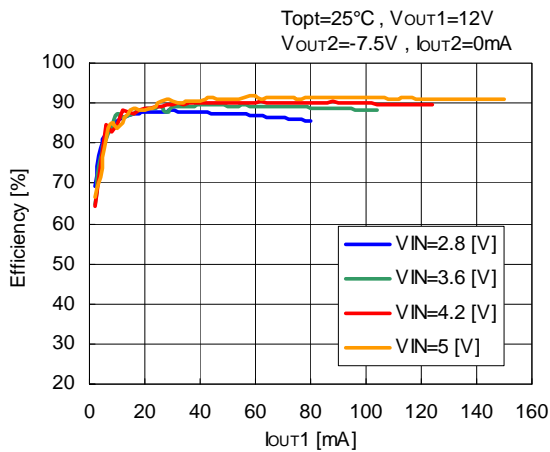

R1283x001A

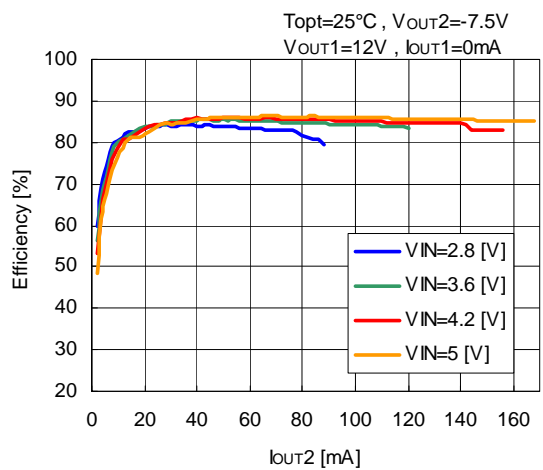

R1283x001B

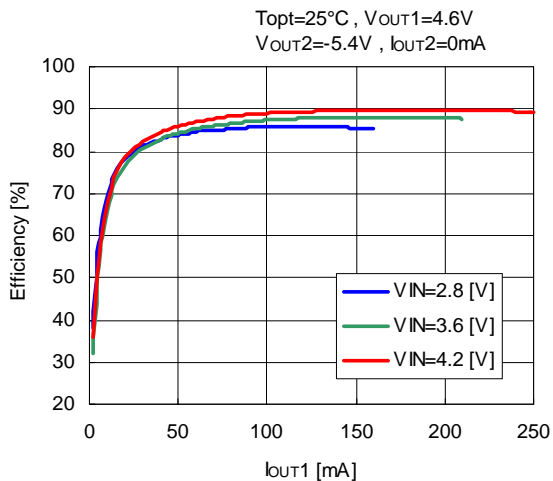

R1283x001B

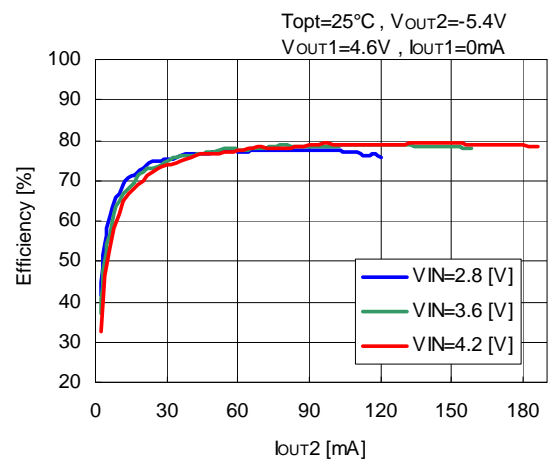

R1283x

R1283x001B

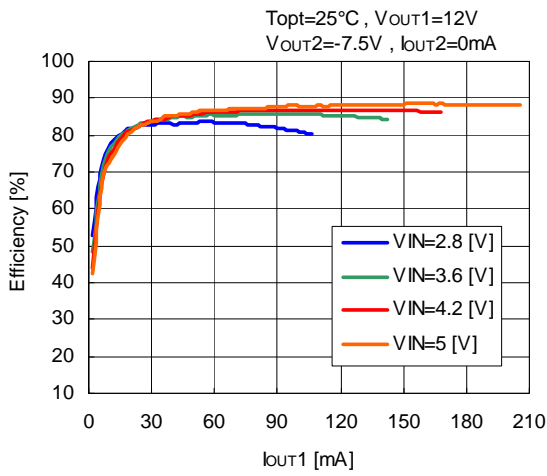

R1283x001B

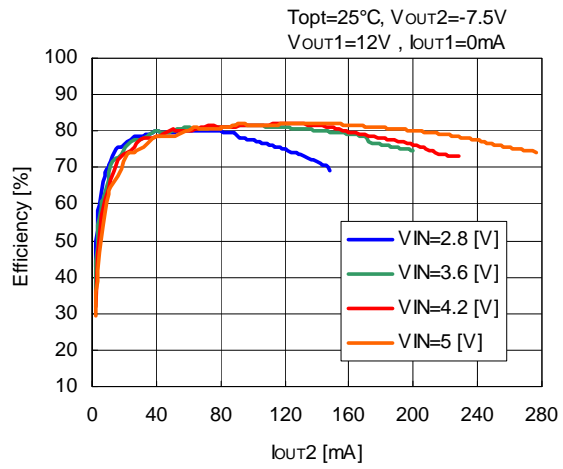

R1283x001C

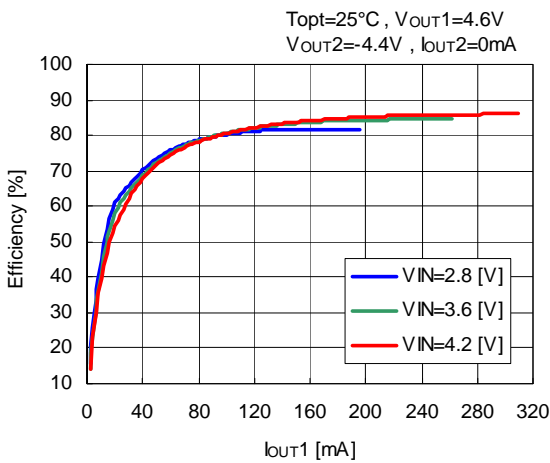

R1283x001C

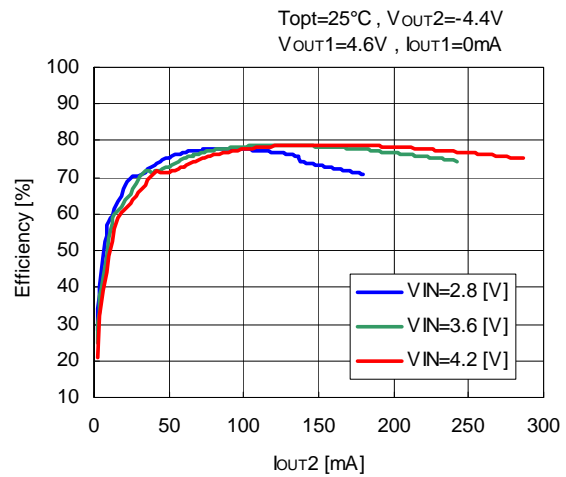

R1283x001C

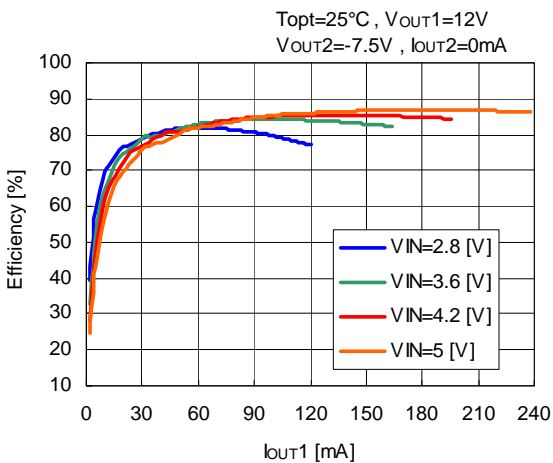

R1283x001C

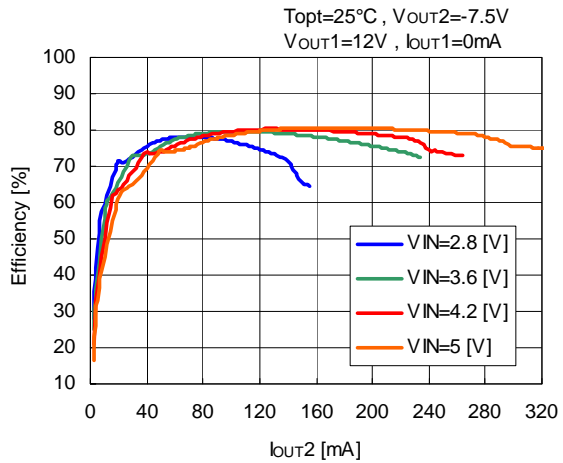

3) CE "L" Input Voltage vs. Temperature
R1283x00xx

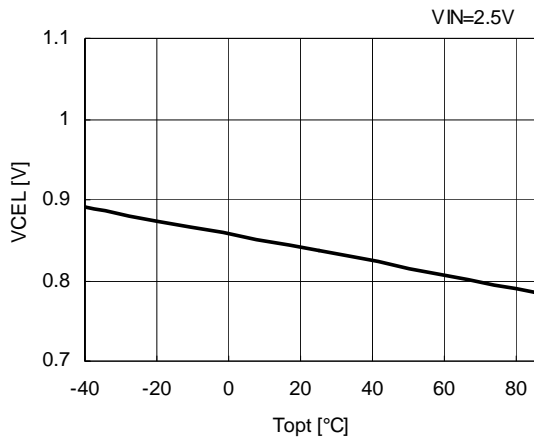

4) CE "H" Input Voltage vs. Temperature
R1283x00xx

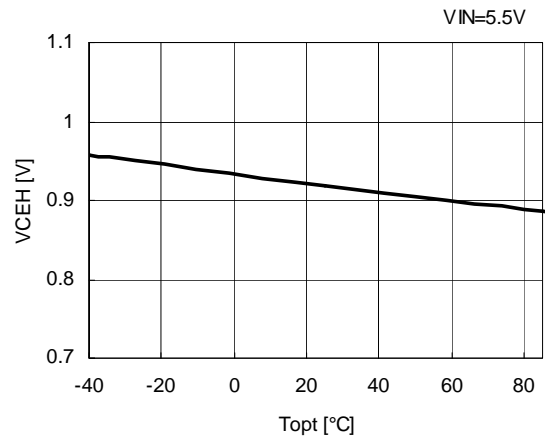

5) VFB1 Voltage vs. Temperature
R1283x00xx

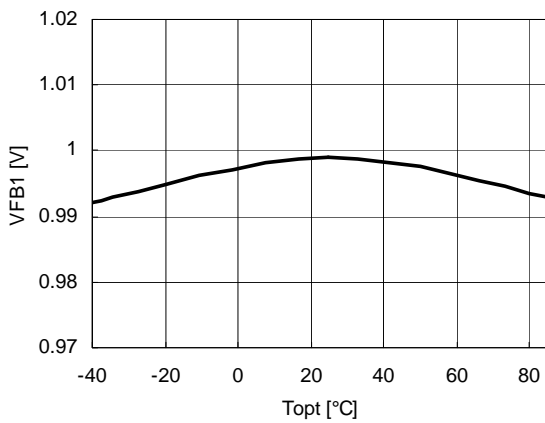

6) VFB2 Voltage vs. Temperature
R1283x00xx

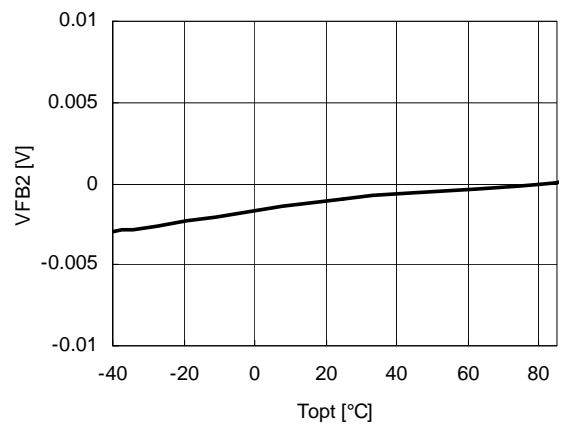

7) VREF Voltage vs. Temperature
R1283x00xx

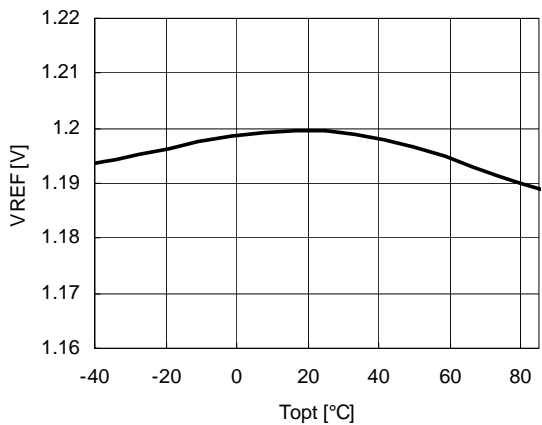

8) UVLO Voltage vs. Temperature
R1283x00xx

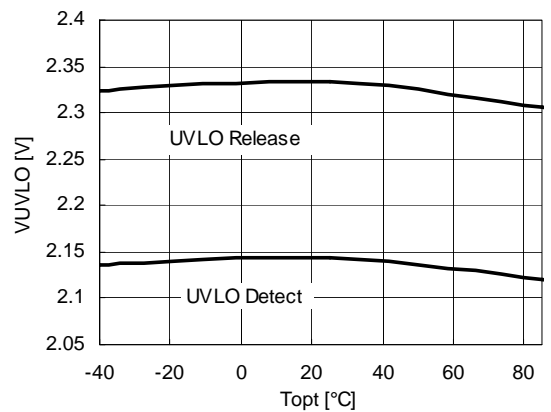

R1283x

**9) LX1 ON Resistance vs. Temperature
R1283x00xx**

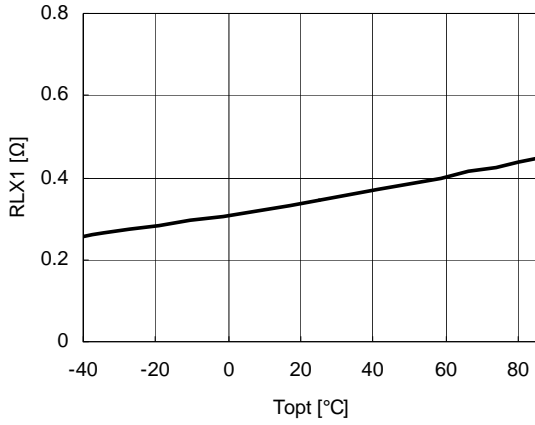

**10) LX2 ON Resistance vs. Temperature
R1283x00xx**

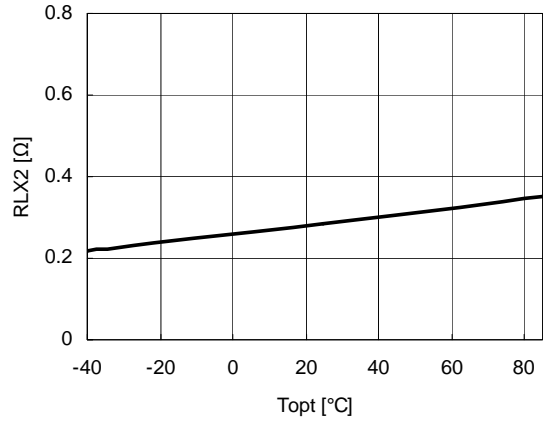

**11) LX1 Limit Current vs. Temperature
R1283x00xx**

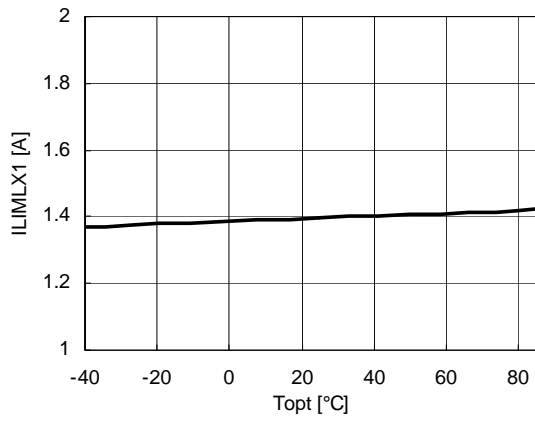

**12) LX2 Limit Current vs. Temperature
R1283x00xx**

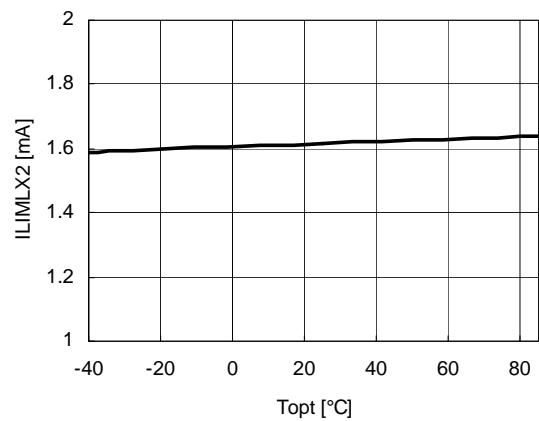

**13) Osillator Frequency vs. Temperature
R1283x00xA**

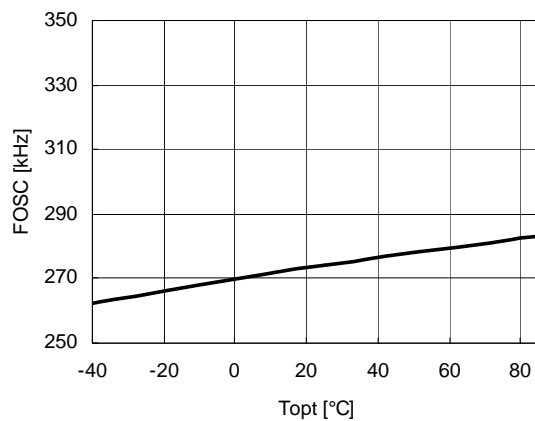

R1283x00xB

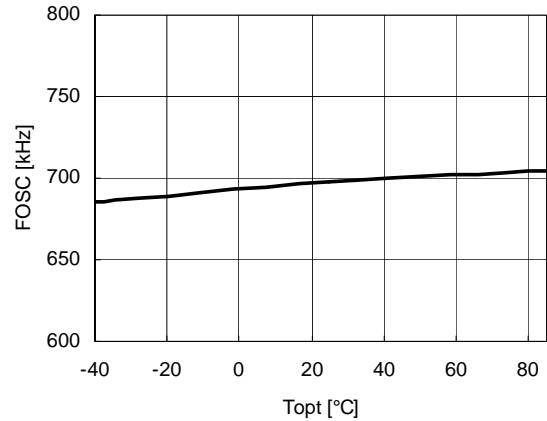

R1283x00xC

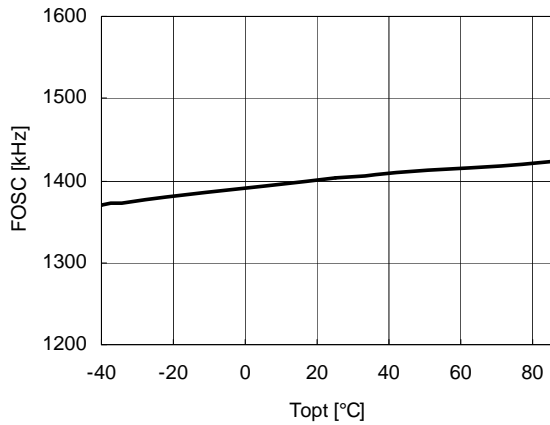

14) Maxduty1 vs. Temperature

R1283x00xA

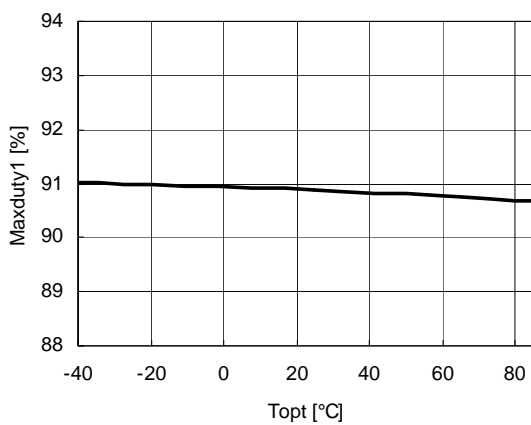

R1283x00xB

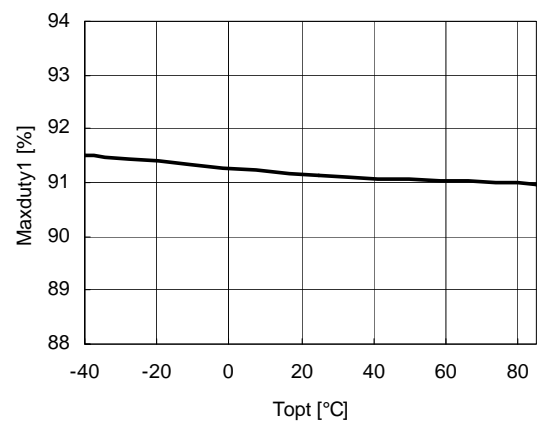

15) Maxduty2 vs. Temperature

R1283x00xC

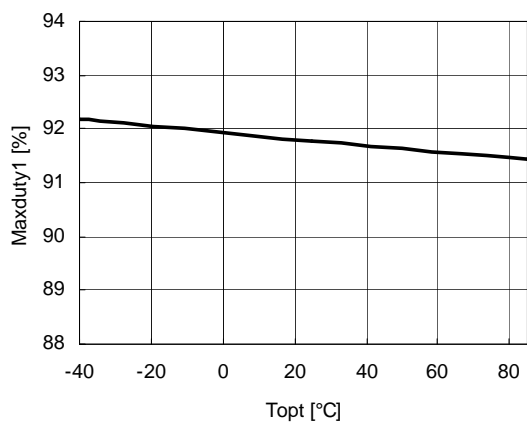

R1283x00xA

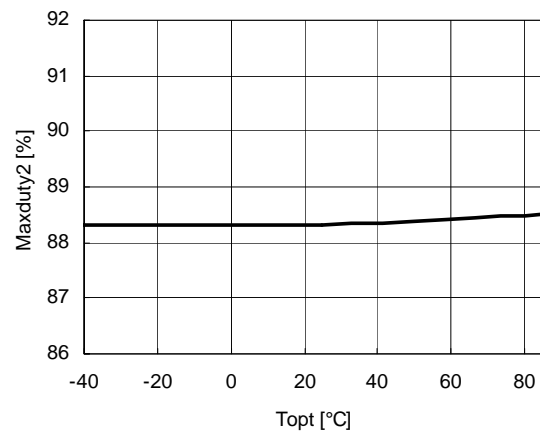

* 1283Z (WLCSP-11-P2) is the discontinued product as of June, 2016.

R1283x

R1283x00xB

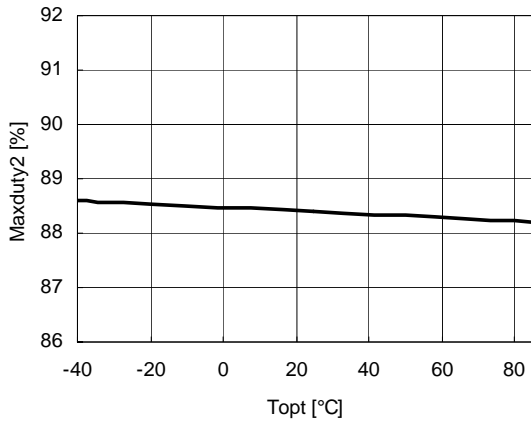

R1283x00xC

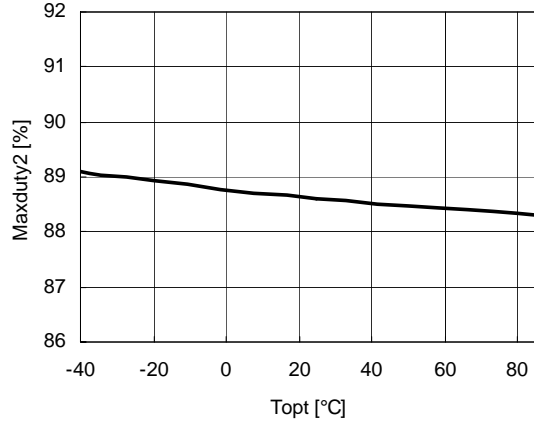

**16) CH1 Soft-start Time vs. Temperature
R1283x00xx**

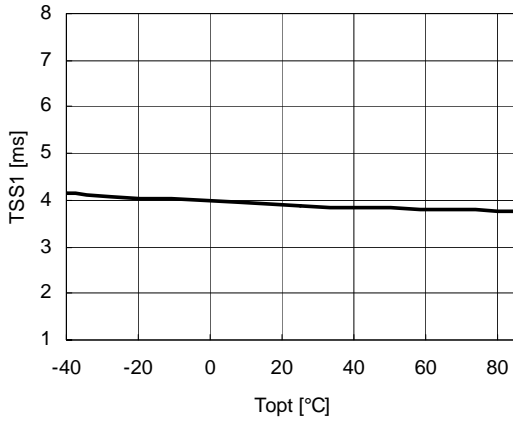

**17) CH2 Soft-start Time vs. Temperature
R1283x00xx**

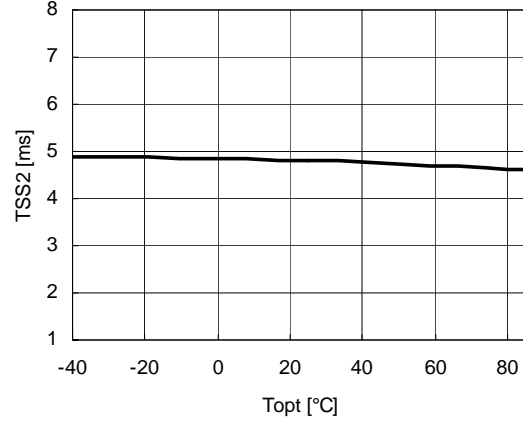

**18) Timer Latch Delay Time vs. Temperature
R1283x00xx**

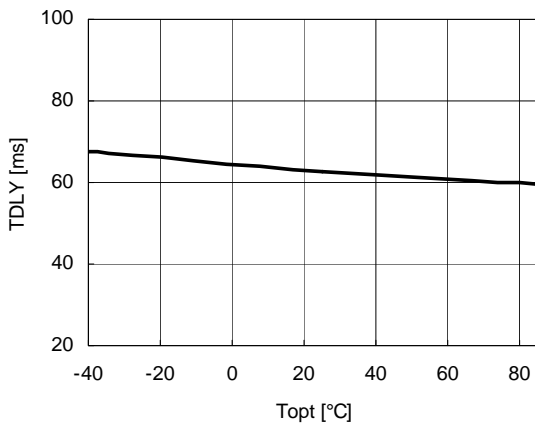

**19) VOUTN Discharge Current vs. Temperature
R1283x00xx**

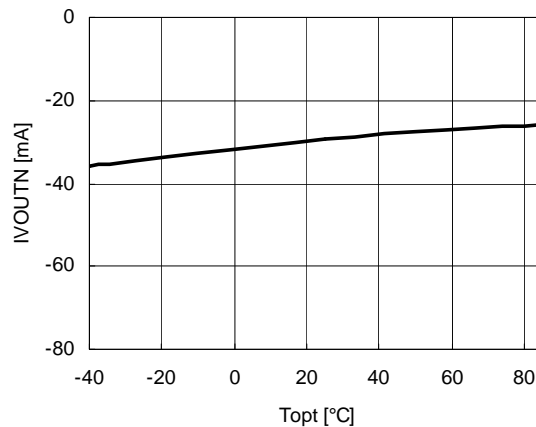

20) Startup Response

R1283x001x

$T_{opt}=25^{\circ}\text{C}$, $V_{IN}=3.6\text{V}$
 $V_{OUT1}=12\text{V}$, $V_{OUT2}=-7.5\text{V}$

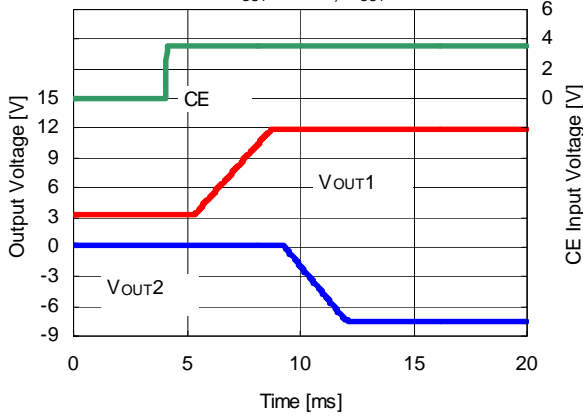

R1283x002x

$T_{opt}=25^{\circ}\text{C}$, $V_{IN}=3.6\text{V}$
 $V_{OUT1}=12\text{V}$, $V_{OUT2}=-7.5\text{V}$

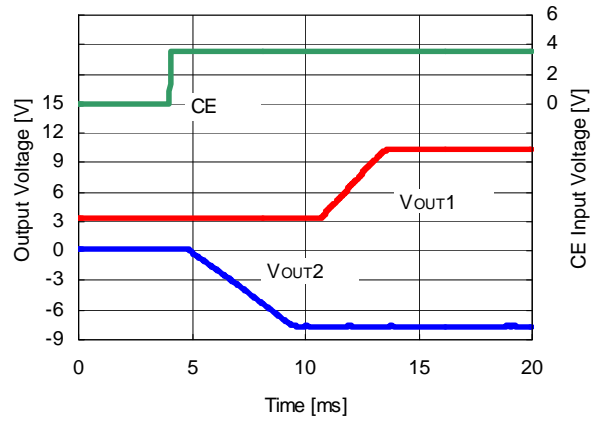

21) Shut down Response

R1283x001x

$T_{opt}=25^{\circ}\text{C}$, $V_{IN}=3.6\text{V}$
 $V_{OUT1}=12\text{V}$, $V_{OUT2}=-7.5\text{V}$
 $I_{OUT1}=10\text{mA}$

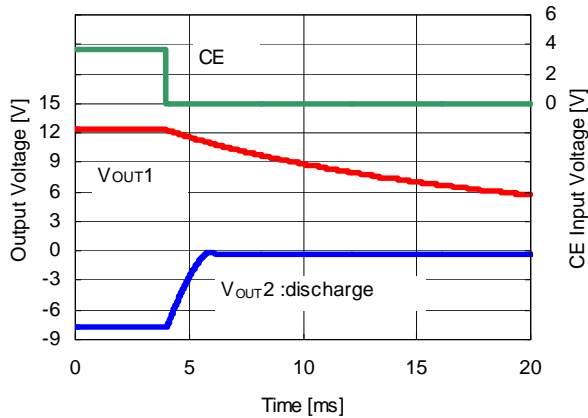

R1283x001x ($V_{OUTN}=\text{Open}$)

$T_{opt}=25^{\circ}\text{C}$, $V_{IN}=3.6\text{V}$
 $V_{OUT1}=12\text{V}$, $V_{OUT2}=-7.5\text{V}$
 $I_{OUT1}=10\text{mA}$

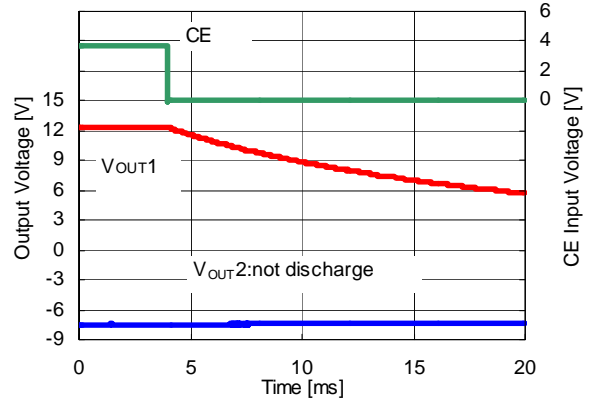

R1283x002x

$T_{opt}=25^{\circ}\text{C}$, $V_{IN}=3.6\text{V}$
 $V_{OUT1}=12\text{V}$, $V_{OUT2}=-7.5\text{V}$
 $I_{OUT1}=10\text{mA}$

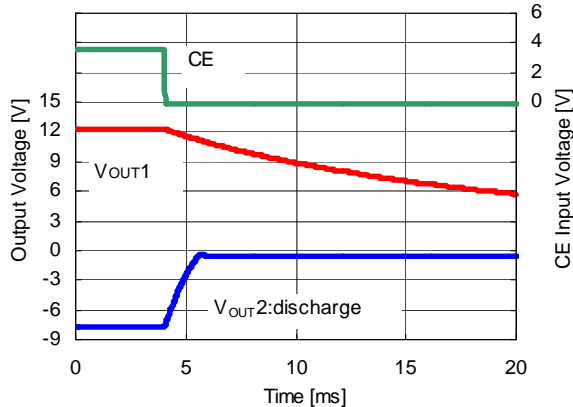

R1283x002x ($V_{OUTN}=\text{Open}$)

$T_{opt}=25^{\circ}\text{C}$, $V_{IN}=3.6\text{V}$
 $V_{OUT1}=12\text{V}$, $V_{OUT2}=-7.5\text{V}$
 $I_{OUT1}=10\text{mA}$

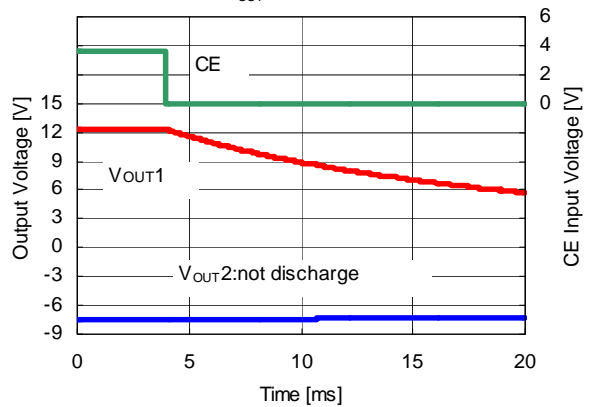

R1283x

22) Load Transient Response

R1283x00xA

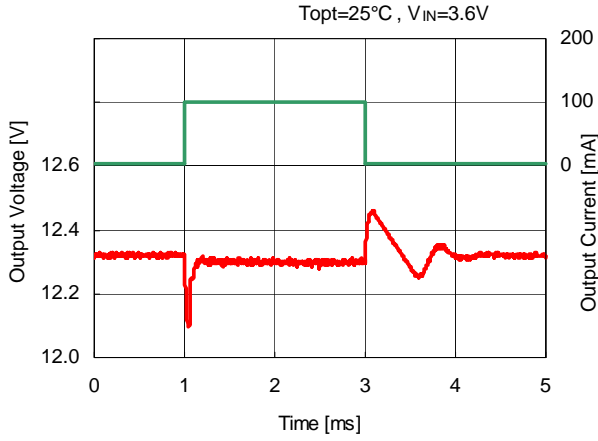

R1283x00xA

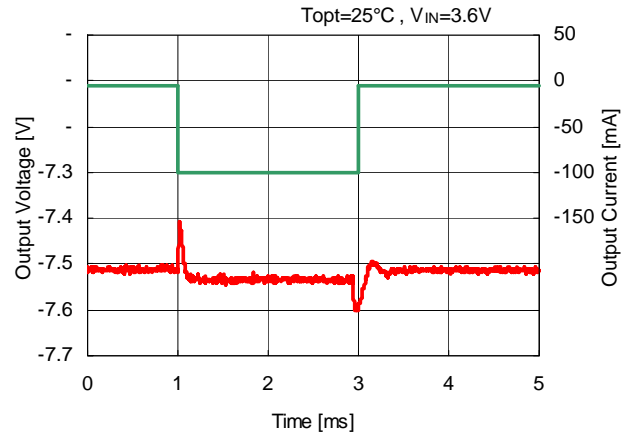

R1283x00xB

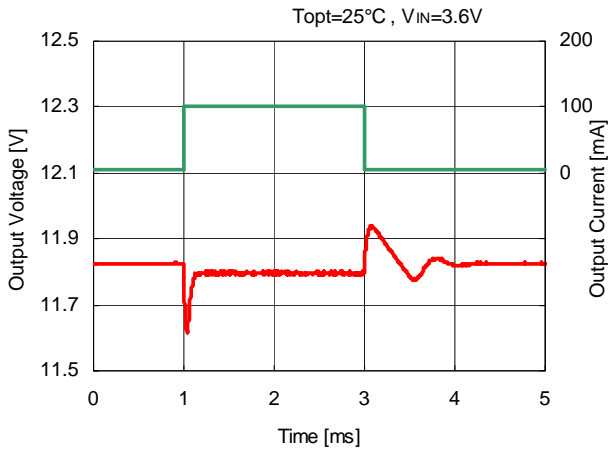

R1283x00xB

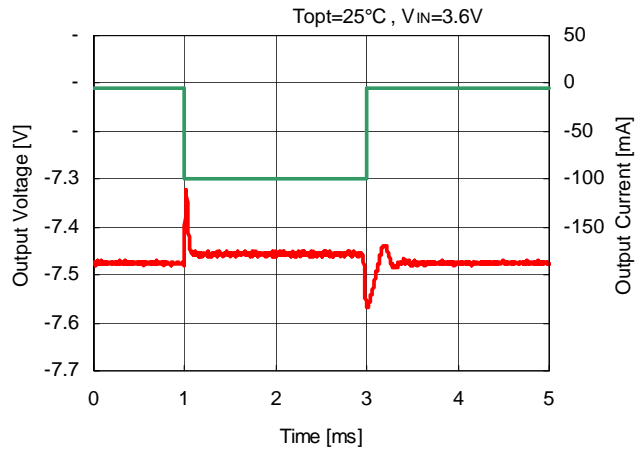

R1283x00xC

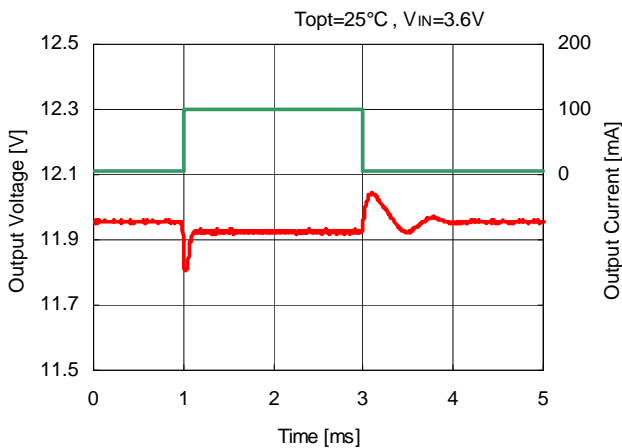

R1283x00xC

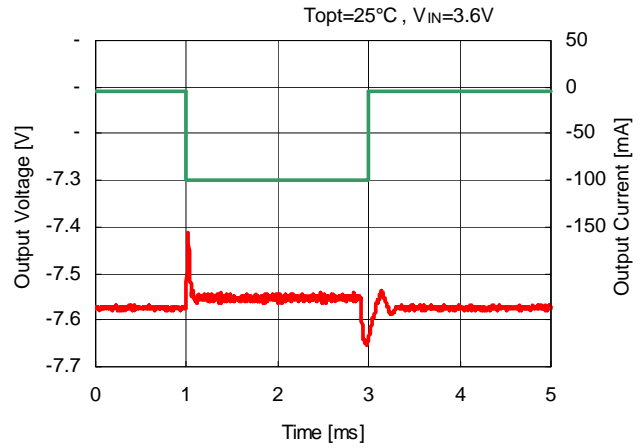

APPLIED CIRCUIT

1) Application with outputting power supply (+12V/-7.5V) for CCD from Li battery

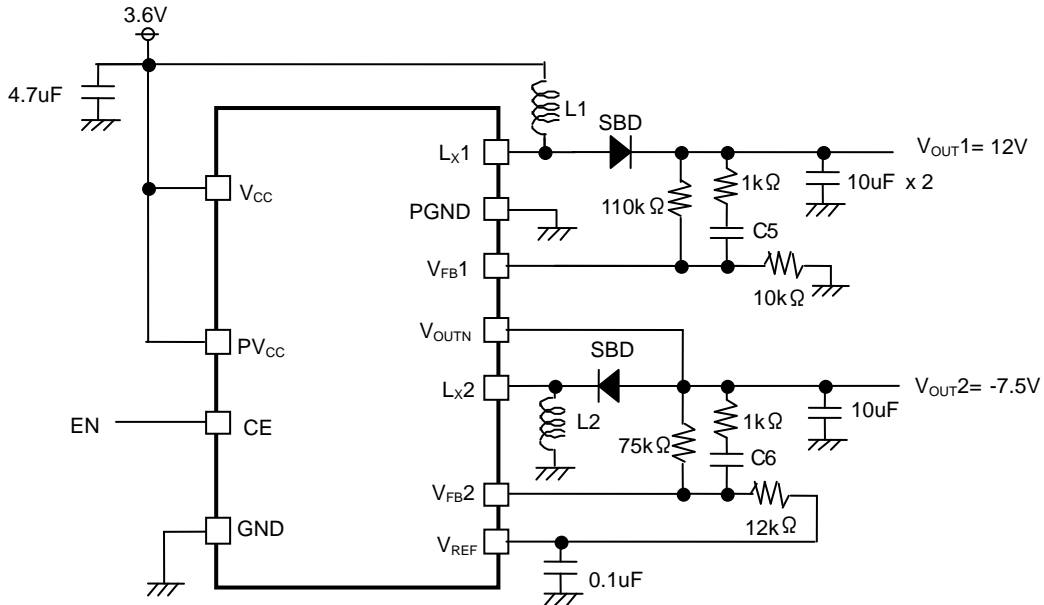

	L1	L2	C5	C6
R1283x00xA	15 μ H	10 μ H	220pF	220pF
R1283x00xB	6.8 μ H	6.8 μ H	150pF	150pF
R1283x00xC	4.7 μ H	4.7 μ H	120pF	120pF

Inductor	VLF3010 (TDK)
SBD	CRS10I30A (TOSHIBA)

2) Application with outputting power supply (+4.6V/-4.4V) for AMOLED from Li battery

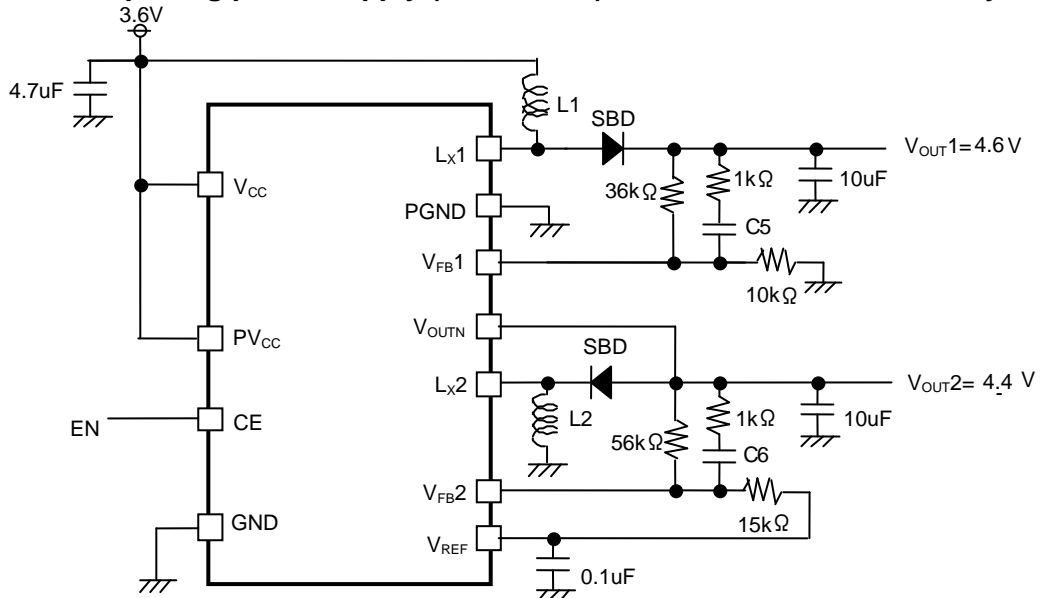

	L1	L2	C5	C6
R1283x00xA	15 μ H	10 μ H	100pF	100pF
R1283x00xB	4.7 μ H	4.7 μ H	47pF	33pF
R1283x00xC	4.7 μ H	4.7 μ H	68pF	47pF

Inductor	VLF3010 (TDK)
SBD	CRS10I30A (TOSHIBA)

R1283x

3) Application with output disconnect and discharge.

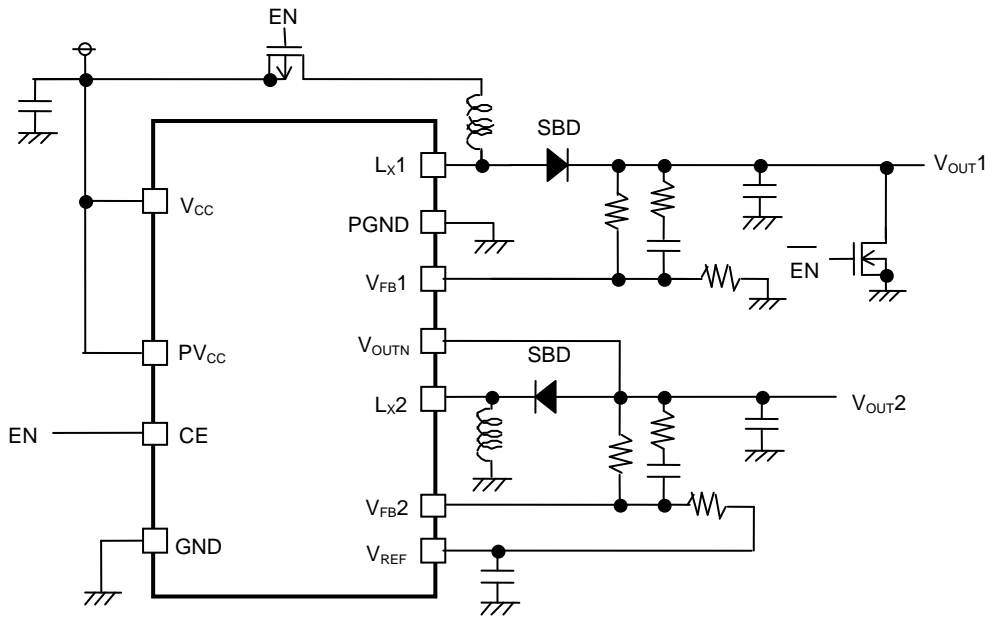



1. The products and the product specifications described in this document are subject to change or discontinuation of production without notice for reasons such as improvement. Therefore, before deciding to use the products, please refer to Ricoh sales representatives for the latest information thereon.
2. The materials in this document may not be copied or otherwise reproduced in whole or in part without prior written consent of Ricoh.
3. Please be sure to take any necessary formalities under relevant laws or regulations before exporting or otherwise taking out of your country the products or the technical information described herein.
4. The technical information described in this document shows typical characteristics of and example application circuits for the products. The release of such information is not to be construed as a warranty of or a grant of license under Ricoh's or any third party's intellectual property rights or any other rights.
5. The products listed in this document are intended and designed for use as general electronic components in standard applications (office equipment, telecommunication equipment, measuring instruments, consumer electronic products, amusement equipment etc.). Those customers intending to use a product in an application requiring extreme quality and reliability, for example, in a highly specific application where the failure or misoperation of the product could result in human injury or death (aircraft, spacevehicle, nuclear reactor control system, traffic control system, automotive and transportation equipment, combustion equipment, safety devices, life support system etc.) should first contact us.
6. We are making our continuous effort to improve the quality and reliability of our products, but semiconductor products are likely to fail with certain probability. In order to prevent any injury to persons or damages to property resulting from such failure, customers should be careful enough to incorporate safety measures in their design, such as redundancy feature, fire containment feature and fail-safe feature. We do not assume any liability or responsibility for any loss or damage arising from misuse or inappropriate use of the products.
7. Anti-radiation design is not implemented in the products described in this document.
8. The X-ray exposure can influence functions and characteristics of the products. Confirm the product functions and characteristics in the evaluation stage.
9. WLCSP products should be used in light shielded environments. The light exposure can influence functions and characteristics of the products under operation or storage.
10. There can be variation in the marking when different AOI (Automated Optical Inspection) equipment is used. In the case of recognizing the marking characteristic with AOI, please contact Ricoh sales or our distributor before attempting to use AOI.
11. Please contact Ricoh sales representatives should you have any questions or comments concerning the products or the technical information.



Ricoh is committed to reducing the environmental loading materials in electrical devices with a view to contributing to the protection of human health and the environment.

Ricoh has been providing RoHS compliant products since April 1, 2006 and Halogen-free products since April 1, 2012.

RICOH RICOH ELECTRONIC DEVICES CO., LTD.

<https://www.e-devices.ricoh.co.jp/en/>

Sales & Support Offices

Ricoh Electronic Devices Co., Ltd.

Shin-Yokohama Office (International Sales)

2-3, Shin-Yokohama 3-chome, Kohoku-ku, Yokohama-shi, Kanagawa, 222-8530, Japan
Phone: +81-50-3814-7687 Fax: +81-45-474-0074

Ricoh Americas Holdings, Inc.

675 Campbell Technology Parkway, Suite 200 Campbell, CA 95008, U.S.A.
Phone: +1-408-610-3105

Ricoh Europe (Netherlands) B.V.

Semiconductor Support Centre

Prof. W.H. Keesomlaan 1, 1183 DJ Amstelveen, The Netherlands
Phone: +31-20-5474-309

Ricoh International B.V. - German Branch

Semiconductor Sales and Support Centre

Oberrather Strasse 6, 40472 Düsseldorf, Germany
Phone: +49-211-6546-0

Ricoh Electronic Devices Korea Co., Ltd.

3F, Haesung Bldg, 504, Teheran-ro, Gangnam-gu, Seoul, 135-725, Korea
Phone: +82-2-2135-5700 Fax: +82-2-2051-5713

Ricoh Electronic Devices Shanghai Co., Ltd.

Room 403, No.2 Building, No.690 Bibo Road, Pu Dong New District, Shanghai 201203,
People's Republic of China
Phone: +86-21-5027-3200 Fax: +86-21-5027-3299

Ricoh Electronic Devices Shanghai Co., Ltd.

Shenzhen Branch

1205, Block D (Jinlong Building), Kingkey 100, Hongbao Road, Luohu District,
Shenzhen, China
Phone: +86-755-8348-7600 Ext 225

Ricoh Electronic Devices Co., Ltd.

Taipei office

Room 109, 10F-1, No.51, Hengyang Rd., Taipei City, Taiwan (R.O.C.)
Phone: +886-2-2313-1621/1622 Fax: +886-2-2313-1623