

---

### Step-up DC/DC converter for White LED Backlight

---

No. EA-166-180704

## OUTLINE

The R1218x Series are PWM control type step-up DC/DC converter ICs with low supply current.

The R1218x is fully dedicated to drive White LED with constant current. Each of these ICs consists of an NMOS FET, an oscillator, a PWM comparator, a voltage reference unit, an error amplifier, a current limit circuit, an under voltage lockout circuit (UVLO), an over-voltage protection circuit (OVP).

The R1218x can drive white LEDs with high efficiency with low supply current. A diode is built-in the R1218xxx1A, therefore it is possible to drive up to 4LEDs without an external diode. The R1218xxx2A, an external diode is necessary, however, up to 7 serial LEDs can be driven with the R1218xxx2A.

Constant current can be set with an external resistance value. Dimming control is possible by PWM signal for CE pin. Feedback voltage is 0.2V, therefore power loss by current setting resistor is small and efficiency is good. Maximum duty cycle is internally fixed, Typ. 91% to 92%. LEDs can be driven from low voltage. Protection circuits are the current limit of Lx peak current, the over voltage limit of output, and the under voltage lockout function.

Packages are standard SOT-23-6 and very tiny DFN(PLP)1820-6.

## FEATURES

- Input voltage..... 1.8V to 5.5V
- Built-in 400mA, 1.5Ω, 20V Nch MOSFET and diode (R1218xxx1A)
- Built-in 400mA, 1.5Ω, 33V Nch MOSFET (R1218xxx2A)
- Oscillator Frequency (PWM control) ..... 1.2MHz
- Maximum Duty Cycle ..... Typ. 91% to 92%
- Feedback Voltage ..... Typ. 0.2V
- UVLO Threshold Voltage ..... Typ. 1.6V (Hysteresis Typ. 0.1V)
- Lx Current limit Protection..... Typ. 700mA
- Over Voltage Protection (OVP) Threshold.... Typ. 9.5V (R1218x021A)  
Typ. 14.0V (R1218x031A)  
Typ. 18.5V (R1218x041A)  
Typ. 23.0V (R1218x052A)  
Typ. 27.5V (R1218x062A)  
Typ. 31.5V (R1218x072A)
- LED dimming control..... by external PWM signal (Frequency 200Hz to 5kHz) to CE pin  
by feedback voltage and filtered PWM signal (high frequency)
- Packages ..... DFN(PLP)1820-6, SOT-23-6

## APPLICATIONS

- White LED Backlight for portable equipment

\* R1218K(DFN(PLP)1820-6) is the limited product as of March 2020.

---

## R1218x

---

No. EA-166-180704

## SELECTION GUIDE

The OVP threshold, the built-in diode, and the package for the ICs can be selected at the user's request.

### Selection Guide

Product Name	Package	Quantity per Reel	Pb Free	Halogen Free
R1218Kxxxx-TR	DFN(PLP)1820-6	5,000 pcs	Yes	Yes
R1218Nxxxx-TR-FE	SOT-23-6	3,000 pcs	Yes	Yes

xxxx: The combination of the OVP threshold and with/without of built-in diode can be designated.

Code	OVP Threshold	Built-in Diode
021A	9.5 V	Yes
031A	14.0 V	Yes
041A	18.5 V	Yes
052A	23.0 V	No
062A	27.5 V	No
072A	31.5 V	No

## BLOCK DIAGRAMS

**R1218xxx1A**

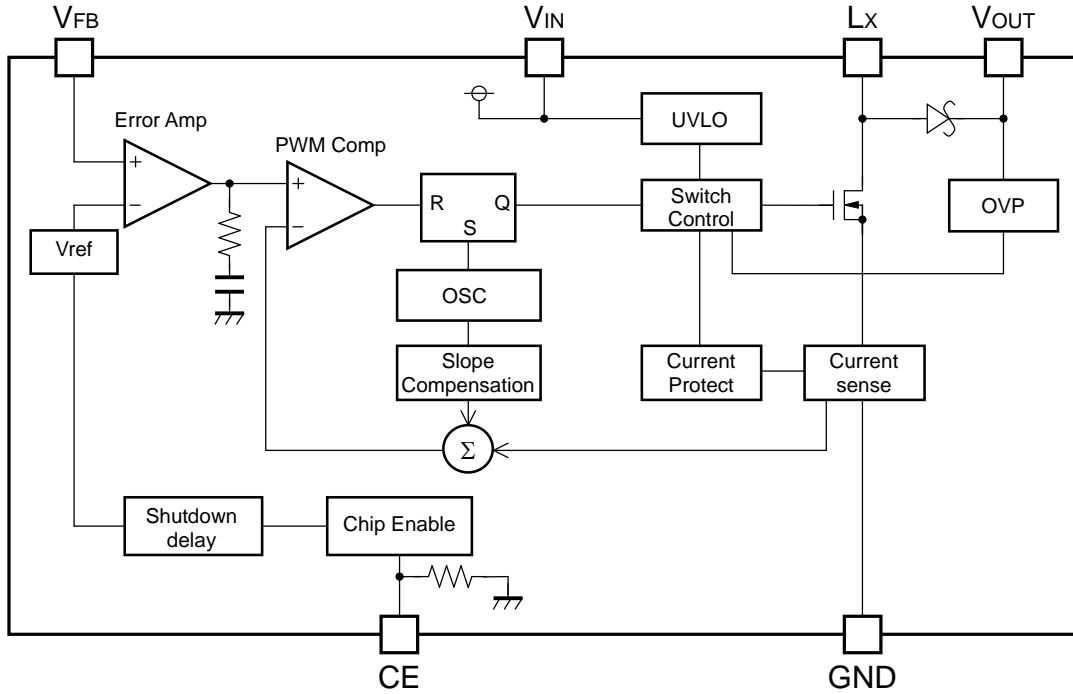

**R1218xxx2A**

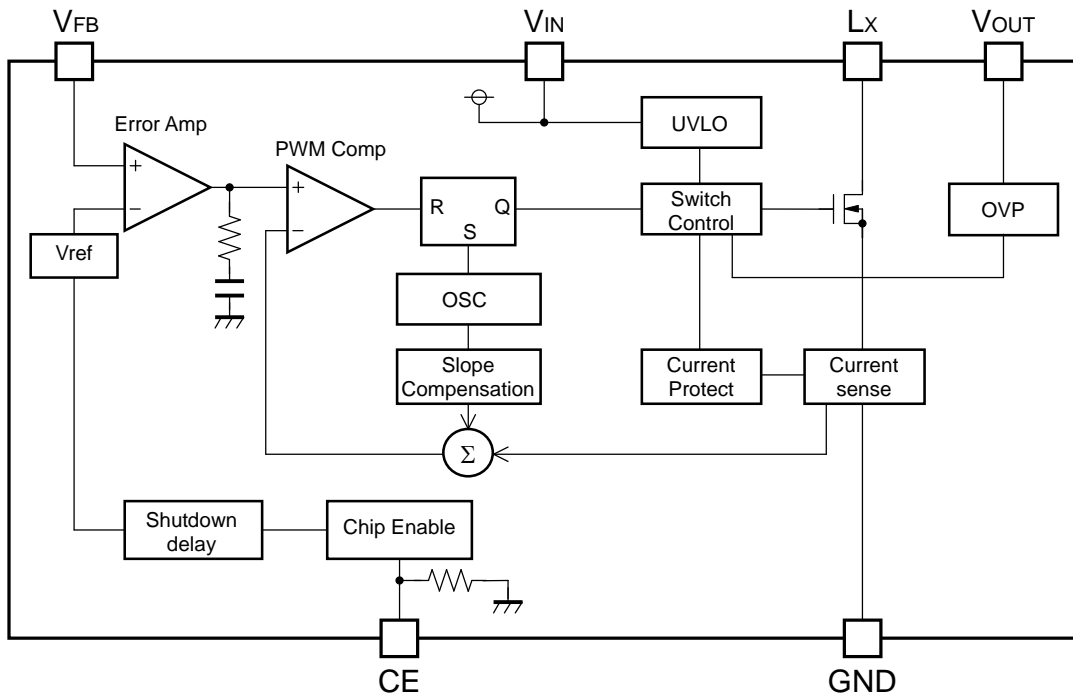

\* R1218K(DFN(PLP)1820-6) is the limited product as of March 2020.

## R1218x

No. EA-166-180704

## PIN DESCRIPTIONS

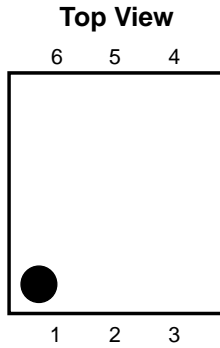

**DFN(PLP)1820-6 Pin Configuration**

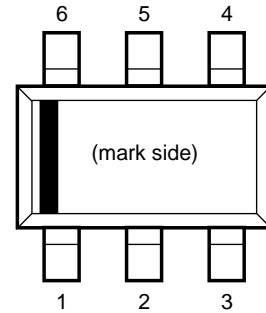
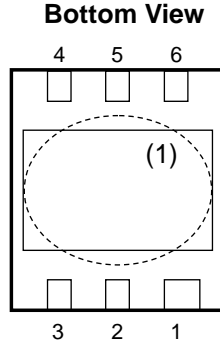

**SOT-23-6 Pin Configuration**

### DFN(PLP)1820-6 Pin Description

Pin No	Symbol	Pin Description
1	CE	Chip Enable Pin ("H" Active)
2	$V_{FB}$	Feedback Pin
3	LX	Switching Pin (Open Drain Output)
4	GND	Ground Pin
5	$V_{IN}$	Power Supply Input Pin
6	$V_{OUT}$	Output Pin

### SOT-23-6 Pin Description

Pin No	Symbol	Pin Description
1	CE	Chip Enable Pin ("H" Active)
2	$V_{OUT}$	Output Pin
3	$V_{IN}$	Power Supply Input Pin
4	LX	Switching Pin (Open Drain Output)
5	GND	Ground Pin
6	$V_{FB}$	Feedback Pin

(1) Tab is GND level (They are connected to the reverse side of this IC). The tab is better to be connected to the GND, but leaving it open is also acceptable.

## ABSOLUTE MAXIMUM RATINGS

### Absolute Maximum Ratings

(GND = 0 V)

Symbol	Item		Rating	Unit	
$V_{IN}$	$V_{IN}$ Pin Voltage		6.5	V	
$V_{CE}$	CE Pin Voltage		-0.3 to $V_{IN} + 0.3$	V	
$V_{FB}$	$V_{FB}$ Pin Voltage		-0.3 to $V_{IN} + 0.3$	V	
$V_{OUT}$	$V_{OUT}$ Pin Voltage	R1218xxx1A	-0.3 to 22	V	
		R1218xxx2A	-0.3 to 34		
$V_{LX}$	$L_X$ Pin Voltage	R1218xxx1A	-0.3 to 22	V	
		R1218xxx2A	-0.3 to 34		
$I_{LX}$	$L_X$ Pin Current		1000	mA	
$P_D$	Power Dissipation <sup>(1)</sup>	DFN(PLP)1820-6	JEDEC STD. 51-7 Test Land Pattern	2200	mW
		SOT-23-6	JEDEC STD. 51-7 Test Land Pattern	660	
$T_j$	Junction Temperature Range		-40 to 125	°C	
$T_{stg}$	Storage Temperature Range		-55 to 125	°C	

### ABSOLUTE MAXIMUM RATINGS

Electronic and mechanical stress momentarily exceeded absolute maximum ratings may cause the permanent damages and may degrade the life time and safety for both device and system using the device in the field. The functional operation at or over these absolute maximum ratings is not assured.

## RECOMMENDED OPERATING CONDITIONS

### Recommended Operating Conditions

Symbol	Item	Rating	Unit
$V_{IN}$	Operating Input Voltage	1.8 to 5.5	V
$T_a$	Operating Temperature Range	-40 to 85	°C

### RECOMMENDED OPERATING CONDITIONS

All of electronic equipment should be designed that the mounted semiconductor devices operate within the recommended operating conditions. The semiconductor devices cannot operate normally over the recommended operating conditions, even if when they are used over such conditions by momentary electronic noise or surge. And the semiconductor devices may receive serious damage when they continue to operate over the recommended operating conditions.

<sup>(1)</sup> Refer to *POWEWR DISSIPATION* for detailed information.

\* R1218K(DFN(PLP)1820-6) is the limited product as of March 2020.

## R1218x

No. EA-166-180704

# ELECTRICAL CHARACTERISTICS

### R1218xxxxA Electrical Characteristics

(Ta = 25°C)

Symbol	Item	Conditions	Min.	Typ.	Max.	Unit	
I <sub>DD</sub>	Supply Current	V <sub>IN</sub> = 5.5 V, V <sub>FB</sub> = 0 V, L <sub>X</sub> at no load		0.5	1.0	mA	
I <sub>standby</sub>	Standby Current	V <sub>IN</sub> = 5.5 V, V <sub>CE</sub> = 0 V		0	3.0	μA	
V <sub>UVLO1</sub>	UVLO Detector Threshold	V <sub>IN</sub> falling	1.5	1.6	1.7	V	
V <sub>UVLO2</sub>	UVLO Released Voltage	V <sub>IN</sub> rising		V <sub>UVLO1</sub> + 0.1	1.8	V	
V <sub>CEH</sub>	CE Input Voltage "H"	V <sub>IN</sub> = 5.5 V	1.5			V	
V <sub>CEL</sub>	CE Input Voltage "L"	V <sub>IN</sub> = 1.8 V			0.5	V	
R <sub>CE</sub>	CE Pull Down Resistance	V <sub>IN</sub> = 3.6 V	600	1200	2200	kΩ	
tshtdn	CE Shutdown Delay Time	V <sub>IN</sub> = 3.6 V		10		ms	
V <sub>FB</sub>	V <sub>FB</sub> Voltage	V <sub>IN</sub> = 3.6 V	0.19	0.20	0.21	V	
ΔV <sub>FB</sub> /ΔTa	V <sub>FB</sub> Voltage Temperature Coefficient	V <sub>IN</sub> = 3.6 V, -40°C ≤ Ta ≤ 85°C		±150		ppm/°C	
I <sub>FB</sub>	V <sub>FB</sub> Input Current	V <sub>IN</sub> = 5.5 V, V <sub>FB</sub> = 0 V or 5.5 V	-0.1		0.1	μA	
R <sub>ON</sub>	Switch On Resistance	V <sub>IN</sub> = 3.6 V, I <sub>SW</sub> = 100 mA		1.5		Ω	
I <sub>LXleak</sub>	Switch Leakage Current	R1218xxx1A	V <sub>LX</sub> = 20 V		0	3.0	μA
		R1218xxx2A	V <sub>LX</sub> = 33 V		0	3.0	μA
I <sub>LXlim</sub>	Switch Current Limit	V <sub>IN</sub> = 3.6 V	400	700	1000	mA	
V <sub>f</sub>	Diode Forward Voltage	R1218xxx1A	I <sub>DIODE</sub> = 100 mA		0.8		V
I <sub>DIODEleak</sub>	Diode Leakage Current	R1218xxx1A	V <sub>OUT</sub> = 20 V, V <sub>LX</sub> = 0 V		10		μA
f <sub>osc</sub>	Oscillator Frequency	V <sub>IN</sub> = 3.6V, V <sub>OUT</sub> = V <sub>FB</sub> = 0V	1.0	1.2	1.4	MHz	
Maxduty	Maximum Duty Cycle	V <sub>IN</sub> = 3.6V, V <sub>OUT</sub> = V <sub>FB</sub> = 0 V	R1218x072A	86	92		%
			Others	86	91		
V <sub>OVP1</sub>	OVP Detector Threshold	V <sub>IN</sub> = 3.6V, V <sub>OUT</sub> rising	R1218x021A	8.5	9.5	10.5	V
			R1218x031A	13.0	14.0	15.0	
			R1218x041A	17.0	18.5	20.0	
			R1218x052A	21.5	23.0	24.5	
			R1218x062A	26.0	27.5	29.0	
			R1218x072A	30.0	31.5	33.0	
V <sub>OVP2</sub>	OVP Released Voltage	V <sub>IN</sub> = 3.6V, V <sub>OUT</sub> falling	R1218x021A		V <sub>OVP1</sub> - 0.5		V
			R1218x031A		V <sub>OVP1</sub> - 0.75		
			R1218x041A		V <sub>OVP1</sub> - 1.0		
			R1218x052A		V <sub>OVP1</sub> - 1.25		
			R1218x062A		V <sub>OVP1</sub> - 1.5		
			R1218x072A		V <sub>OVP1</sub> - 1.75		

## APPLICATION INFORMATION

### • Typical Application Circuit

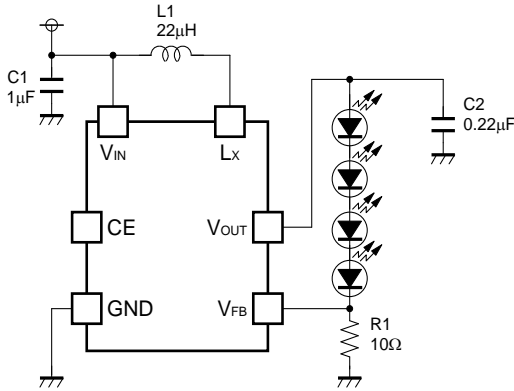

R1218x041A

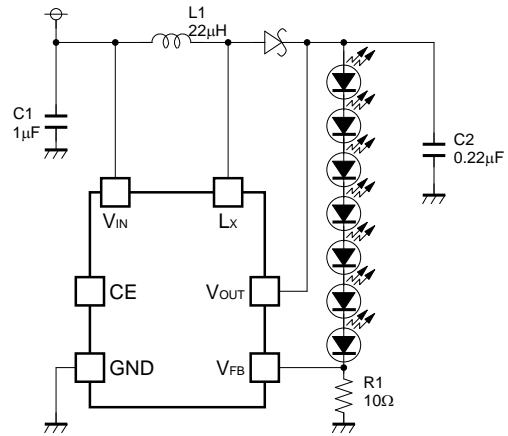

R1218x072A

### • Selection of Inductors

The peak current of the inductor at normal mode can be estimated as the next formula when the efficiency is 80%.

$$I_{Lmax} = 1.25 \times I_{OUT} \times V_{OUT} / V_{IN} + 0.5 \times V_{IN} \times (V_{OUT} - V_{IN}) / (L \times V_{OUT} \times f_{osc})$$

When the start-up or dimming control by CE pin, transient current flows, the peak current must be equal or less than the current limit of the IC. The peak current should not be beyond the rating current of the inductor. The recommended inductance value is 10 µH -22 µH.

Table 1 Peak current value in each condition

Condition				
V <sub>IN</sub> (V)	V <sub>OUT</sub> (V)	I <sub>OUT</sub> (mA)	L (µH)	I <sub>Lmax</sub> (mA)
3	14	20	10	215
3	14	20	22	160
3	21	20	10	280
3	21	20	22	225

Table 2 Recommended inductors

L (µH)	Part No.	Rated Current (mA)	Size (mm)
10	LQH32CN100K53	450	3.2 x 2.5 x 1.55
10	LQH2MC100K02	225	2.0 x 1.6 x 0.9
10	VLF3010A-100	490	2.8 x 2.6 x 0.9
10	VLS252010-100	520	2.5 x 2.0 x 1.0
22	LQH32CN220K53	250	3.2 x 2.5 x 1.55
22	LQH2MC220K02	185	2.0 x 1.6 x 0.9
22	VLF3010A-220	330	2.8 x 2.6 x 0.9

---

## R1218x

No. EA-166-180704

---

### ● Selection of Capacitors

Set 1  $\mu\text{F}$  or more value bypass capacitor C1 between  $V_{\text{IN}}$  pin and GND pin as close as possible.

Set 0.22  $\mu\text{F}$  or more capacitor C2 between  $V_{\text{OUT}}$  and GND pin.

Note the  $V_{\text{OUT}}$  that depends on LED used, and select the rating of  $V_{\text{OUT}}$  or more.

### ● Selection of SBD (Schottky Barrier Diode )

Select the diode with low  $V_{\text{F}}$  such as Schottky type with low reverse current  $I_{\text{R}}$ , and with low capacitance.

Table 3 Recommended components

	Rated voltage (V)	Part No.
C1	6.3	CM105B105K06
C2	25	GRM21BR11E224
	50	GRM21BR71H224
D1	30	CRS10I30A
	30	RSX051VA-30

### ● LED Current setting

LED current can be set with feedback resistor (R1)

$$I_{\text{LED}} = 0.2 / R1$$

### ● LED Dimming Control, Softstart

(1) LED dimming control by PWM signal to CE pin

LED dimming control is possible by forcing PWM signal to CE pin.

When the power-on or start up with CE pin, softstart function works, however, after that, if the CE pin is set as "L" and set CE pin "H" again during the shutdown delay time, softstart function is disabled and starts up fast to normal mode, therefore 200 Hz to 5 kHz PWM signal is standard. By the CE pin input, LED turns on and off. Average LED current varies depending on the duty cycle of CE input. Too high frequency PWM signal is not effective because of its delay.

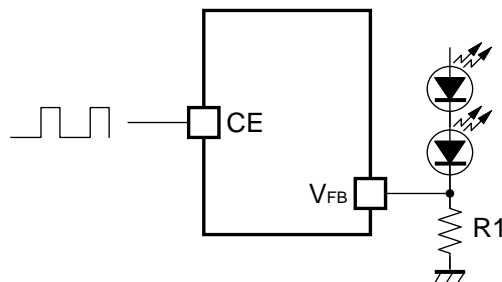

Dimming control by CE pin input



(2) Dimming control by DC voltage

LED dimming control is also possible by using the DC voltage to  $V_{FB}$  pin. LED current is adjustable by DC voltage and resistors, R1 and R2 in the following figure.

$$I_{LED} = 0.2/R1 - (DC - 0.2)/R2$$

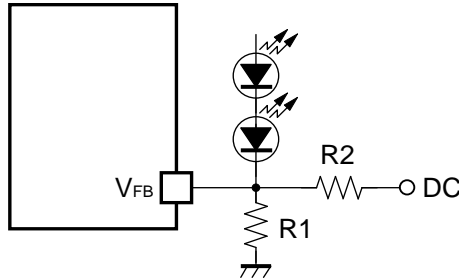

**Dimming control by DC voltage**

(3) Dimming control by feedback voltage and filtered PWM signal

LED dimming control is also possible by using the feedback voltage and filtered PWM signal.

LED current is adjustable according to the "H" level ( $V_H$ ) and "L" level ( $V_L$ ) of PWM signal and resistors, R1, R2, R3, and R4 in the following figure.

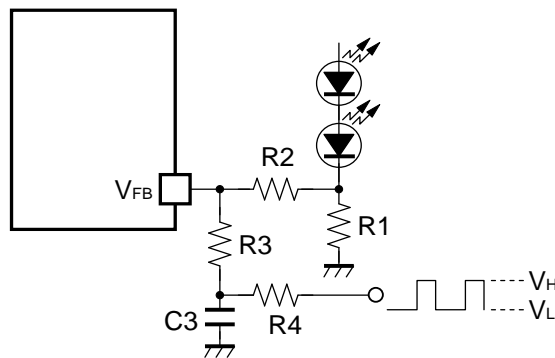

**Dimming control by filtered PWM signal**

Duty = 0% to 100% PWM signal duty cycle can be used up to the maximum LED current and minimum LED current as in the next formulas.

$$I_{LEDMIN} = \{0.2 - R2 \times (V_H - 0.2) / (R3 + R4)\} / R1$$

$$I_{LEDMAX} = \{0.2 - R2 \times (V_L - 0.2) / (R3 + R4)\} / R1$$

For example, supposed that the PWM signal level is set as 2.5 V/0 V, to adjust the LED current range from 0 mA to 20 mA by the duty cycle, our recommendation external components values are,  $R1 = 10 \Omega$ ,  $R2 = 5.1 \text{ k}\Omega$ ,  $R3 = 51 \text{ k}\Omega$ ,  $R4 = 5.1 \text{ k}\Omega$  or around.

C3 should be set large enough to regard the PWM signal as adjustable DC voltage by the filter. In this method, higher frequency control than the frequency against the CE pin can be used for dimming control. For example, if the frequency is 40 kHz, 0.1  $\mu\text{F}$  or more capacitor is our recommendation value as C3.

---

## R1218x

No. EA-166-180704

---

### TECHNICAL NOTES

#### ●Current path on PCB

The current paths in an application circuit are shown in Fig. 1 and 2.

A current flows through the paths shown in Fig. 1 at the time of MOSFET-ON, and shown in Fig. 2 at the time of MOSFET-OFF. In the paths pointed with red arrows in Fig. 2, current flows just in MOSFET-ON period or just in MOSFET-OFF period. Parasitic impedance/inductance and the capacitance of these paths influence stability of the system and cause noise outbreak. So please minimize this side effect. In addition, please shorten the wiring of other current paths shown in Fig. 1 and 2 except for the paths of LED load.

#### ●Layout Guide for PCB

- Please shorten the wiring of the input capacitor (C1) between VIN pin and GND pin of IC. The GND pin should be connected to the strong GND plane.
- The area of LX land pattern should be smaller.
- In the case of internal diode version, please put output capacitor (C2) close to the VOUT pin.
- In the case of external diode, the wiring between L<sub>x</sub> pin and inductor and diode should be short and please put output capacitor(C2) close to the cathode of diode.
- Please make the GND side of output capacitor (C2) close to the GND pin of IC.

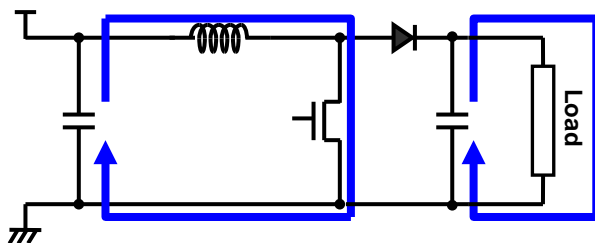

Fig. 1 MOSFET-ON

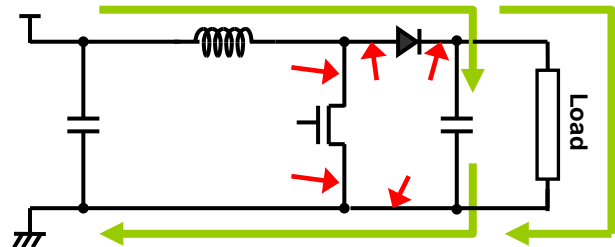
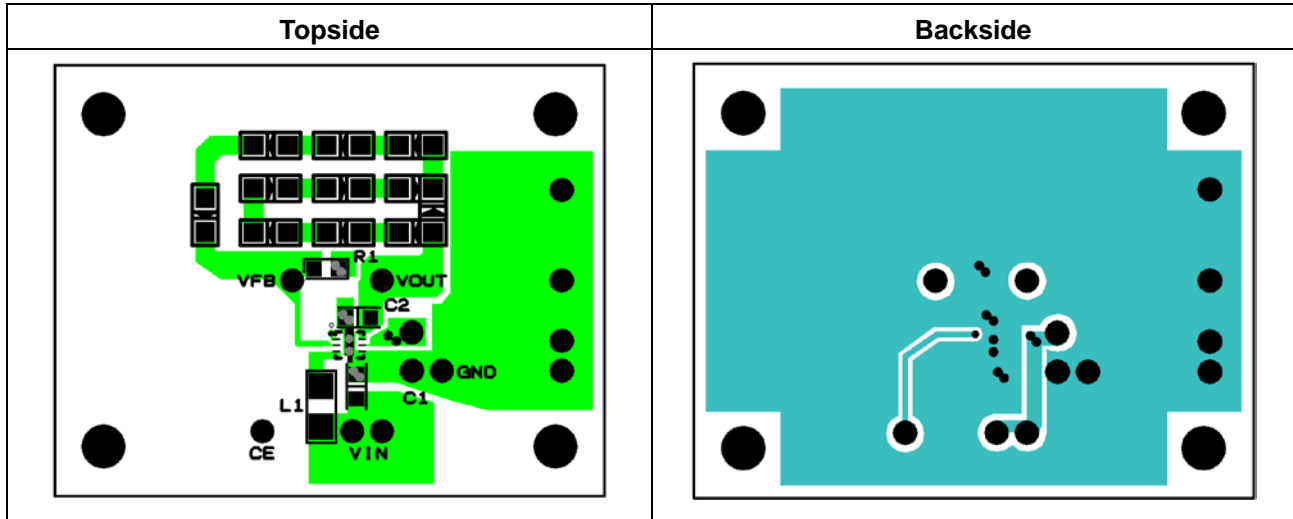

Fig. 2 MOSFET-OFF

●PCB Layout

- PKG: DFN(PLP)1820-6 pin

R1218Kxx1A



R1218Kxx2A

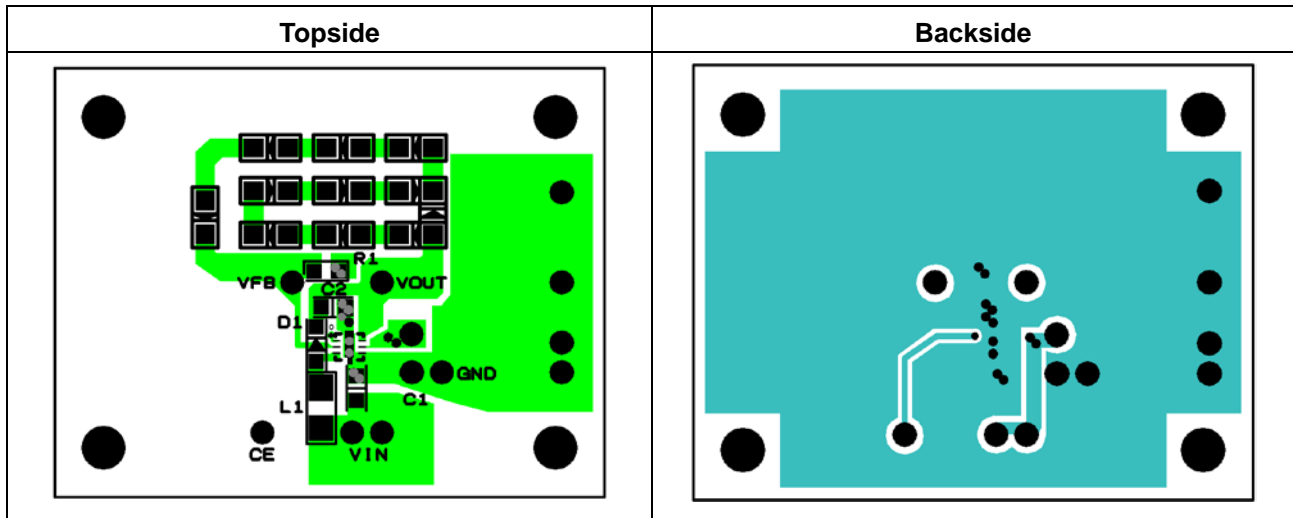

\* R1218K(DFN(PLP)1820-6) is the limited product as of March 2020.

## R1218x

No. EA-166-180704

- PKG: SOT-23-6 pin

R1218Nxx1A/xx2A

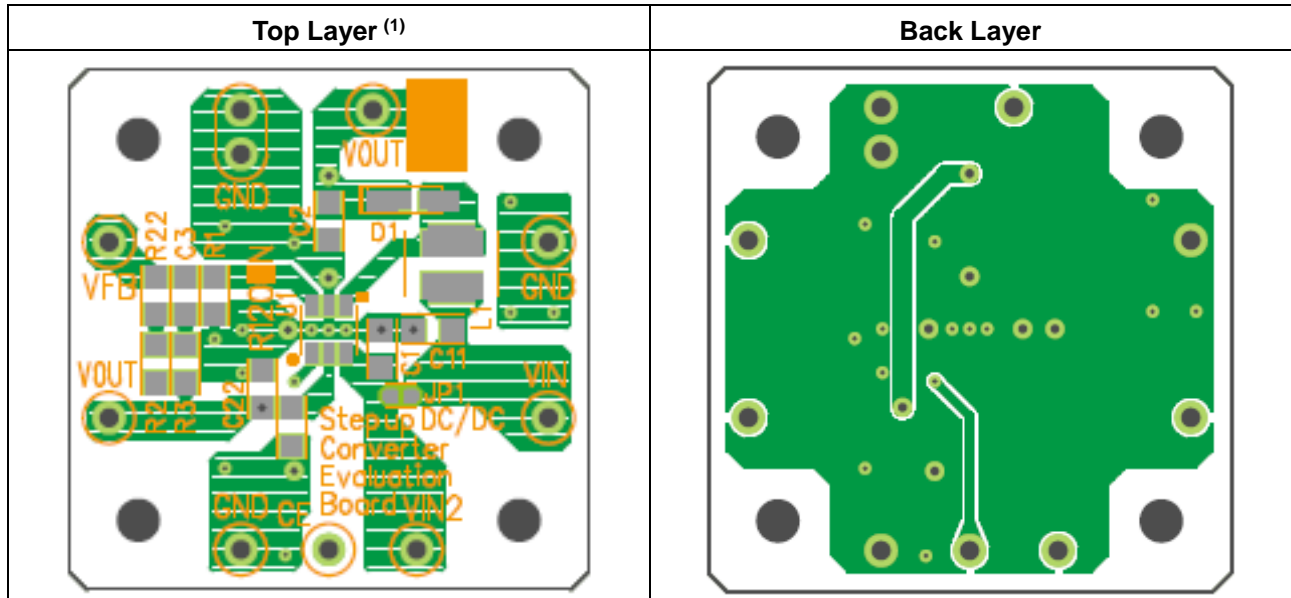

<sup>(1)</sup> U1-● indicates the position of No.1 pin.

## TYPICAL CHARACTERISTICS

### 1) Efficiency vs. LED Current (2 LED) L: LQH32CN220 (Ta = 25°C)

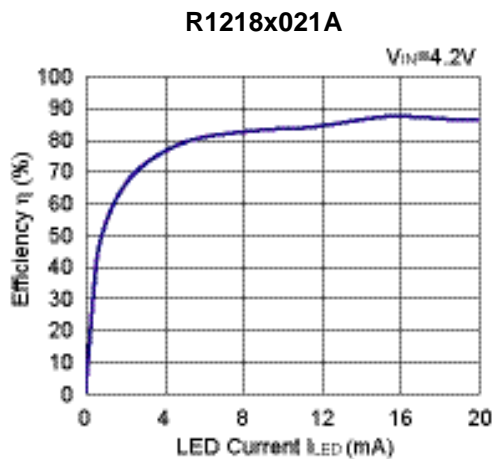
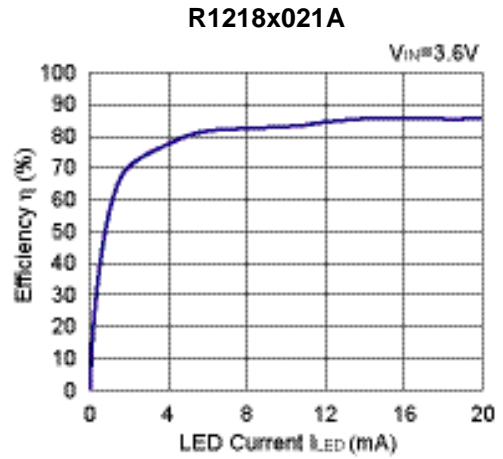
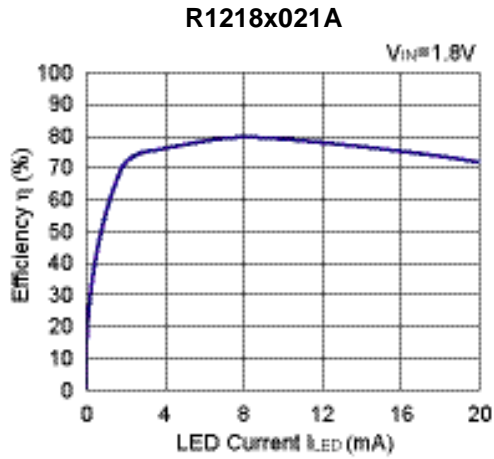

### 2) Efficiency vs. LED Current (3 LED) L: LQH32CN220 (Ta = 25°C)

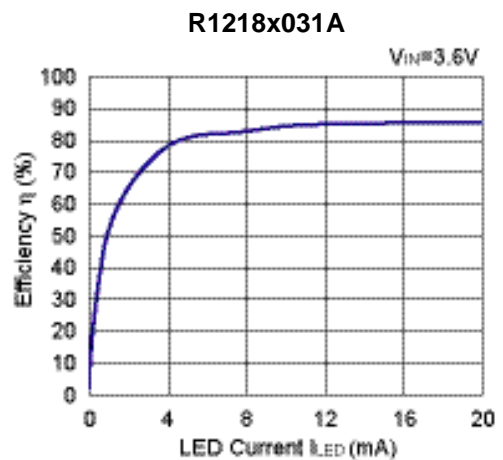
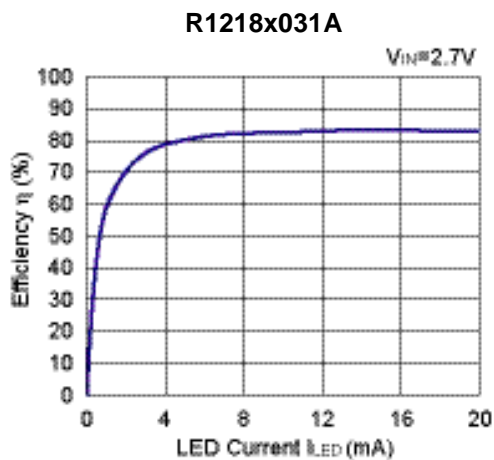

\* R1218K(DFN(PLP)1820-6) is the limited product as of March 2020.

## R1218x

No. EA-166-180704

R1218x031A

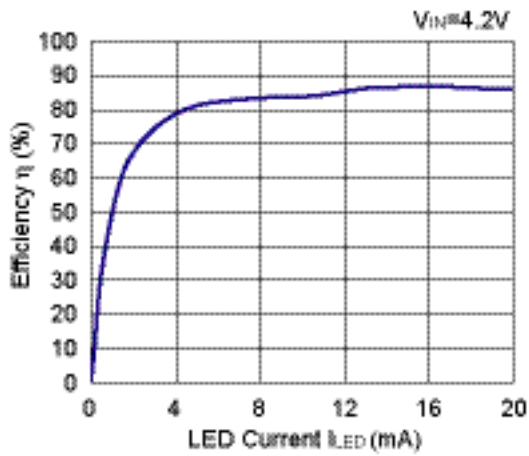

### 3) Efficiency vs. LED Current (4 LED) L: LQH32CN220 ( $T_a = 25^\circ C$ )

R1218x041A

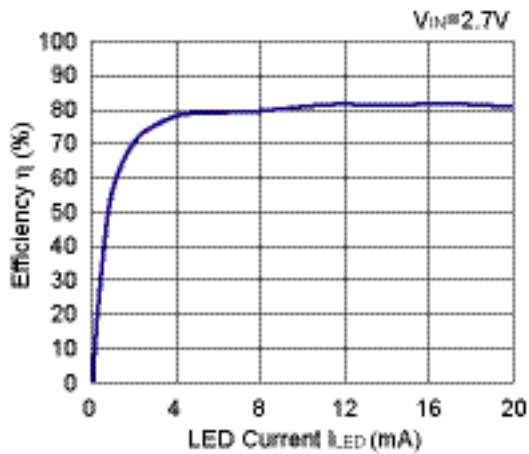

R1218x041A

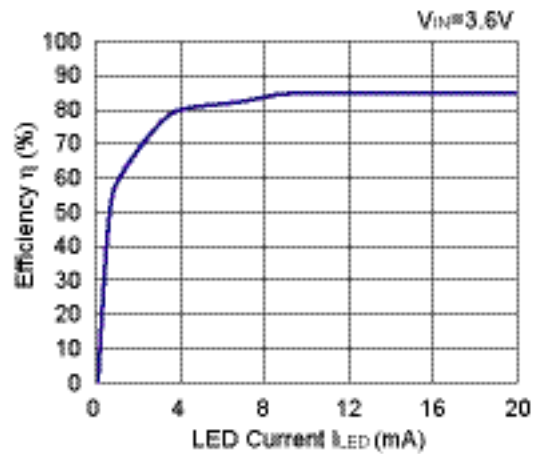

R1218x041A

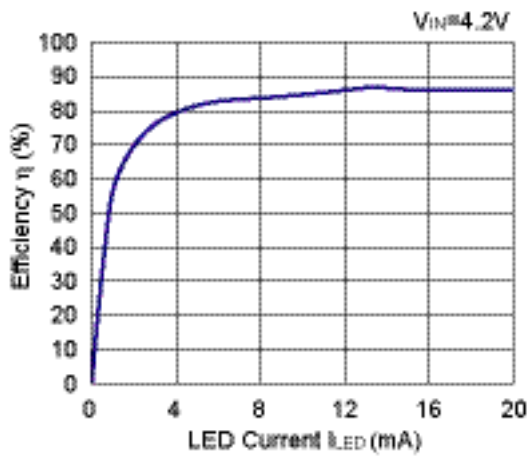

4) Efficiency vs. LED Current (6 LED) L: LQH32CN220, Diode: CRS02 (Ta = 25°C)

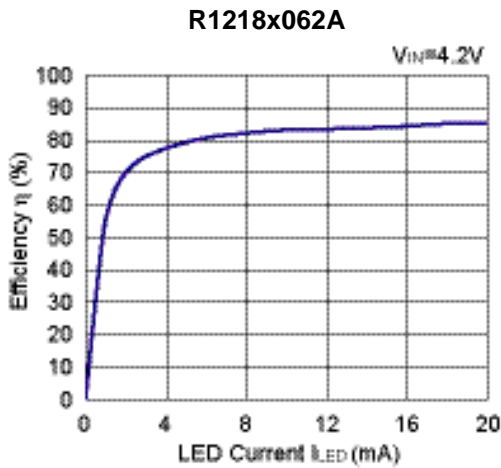
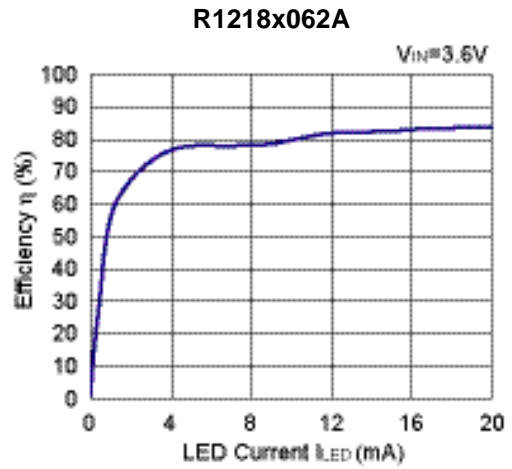
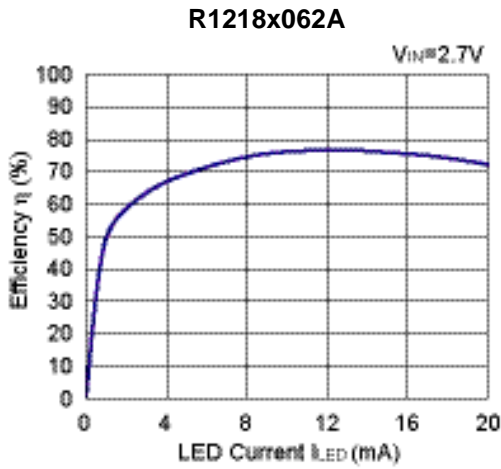

5) Efficiency vs. LED Current (7 LED) L: LQH32CN220, Diode: CRS02 (Ta = 25°C)

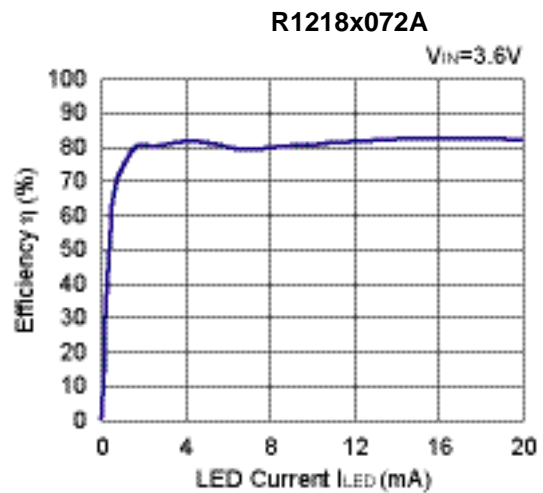
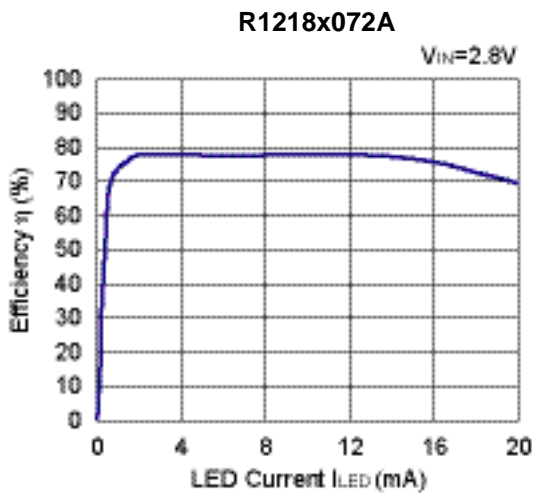

**R1218x**

No. EA-166-180704

**R1218x072A**

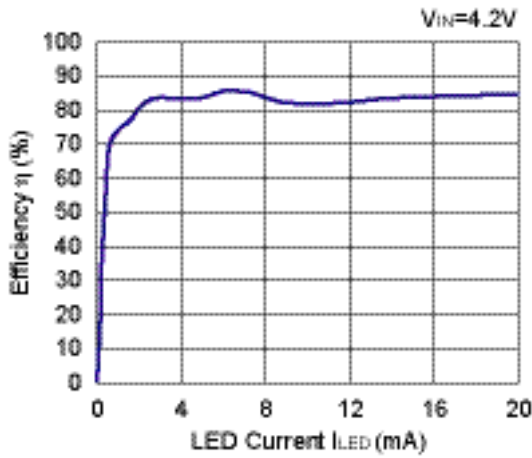

**6) PWM Dimming Control (2 LED)  $V_{IN} = 3.6 V$ ,  $R1 = 10 \Omega$**

**6-1. Duty vs. LED Current (2 LED) ( $T_a = 25^\circ C$ )**

**R1218x021A**

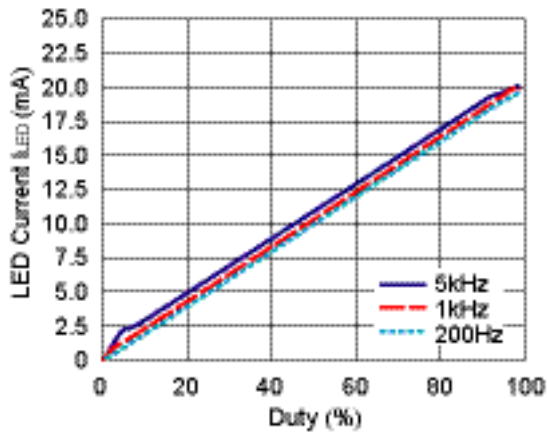

**6-2. Output Voltage Waveform (2 LED) ( $T_a = 25^\circ C$ )**

**R1218x021A**

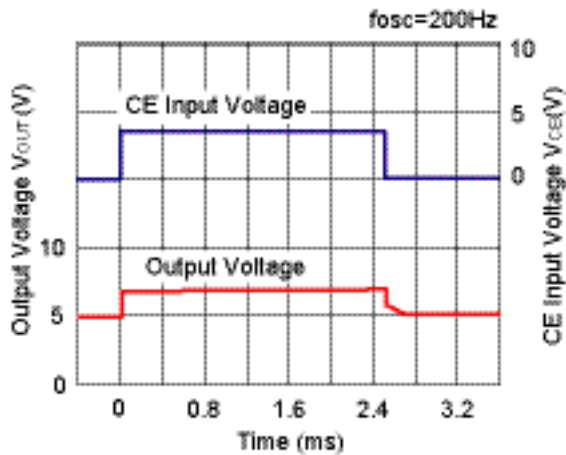

**R1218x021A**

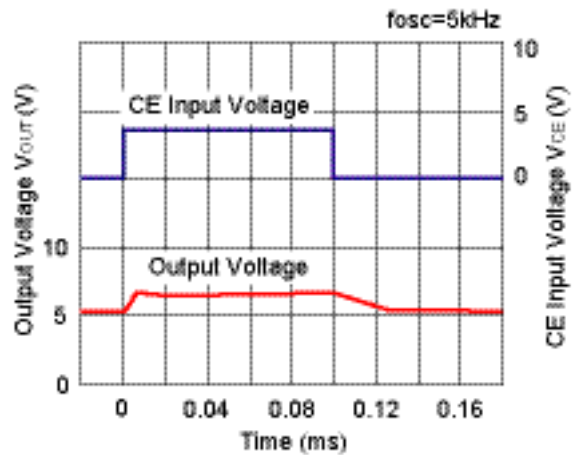



7) PWM Dimming Control (4 LED)  $V_{IN} = 3.6\text{ V}$ ,  $R1 = 10\ \Omega$

7-1. Duty vs. LED Current (4 LED) ( $T_a = 25^\circ\text{C}$ )

R1218x041A

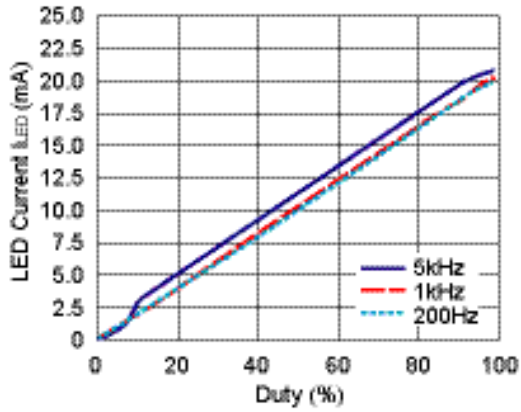

7-2. Output Voltage Waveform (4 LED) ( $T_a = 25^\circ\text{C}$ )

R1218x041A

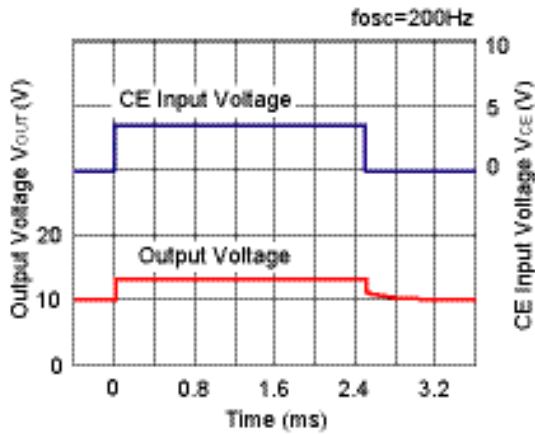

R1218x041A

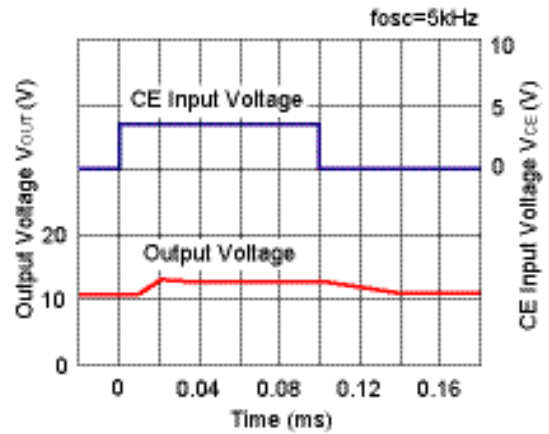

8) PWM Dimming Control (6 LED)  $V_{IN} = 3.6\text{ V}$ ,  $R1 = 10\ \Omega$

8-1. Duty vs. LED Current (6 LED) ( $T_a = 25^\circ\text{C}$ )

R1218x062A

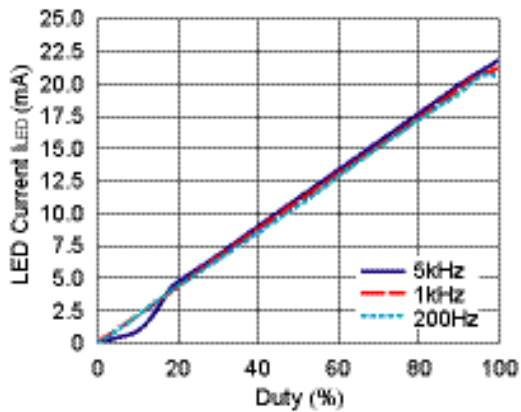

**R1218x**

No. EA-166-180704

**8-2. Output Voltage Waveform (6 LED) (Ta = 25°C)**

R1218x062A

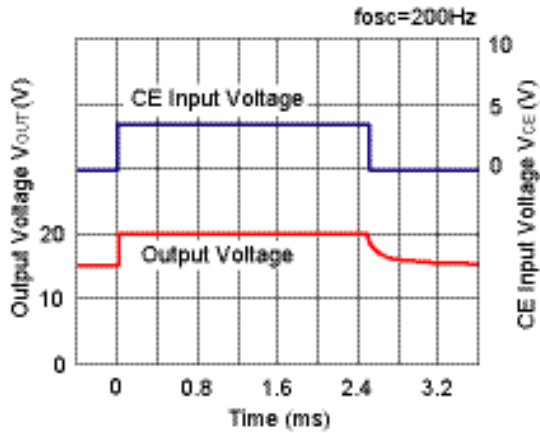

R1218x062A

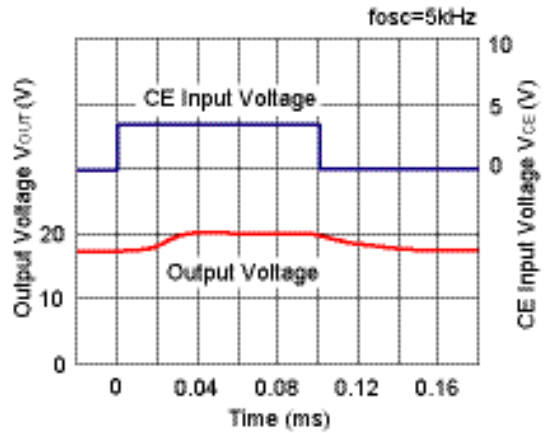

**9) PWM Dimming Control (7 LED) VIN = 3.6 V, R1 = 10 Ω**

**9-1. Duty vs. LED Current (7 LED) (Ta = 25°C)**

R1218x072A

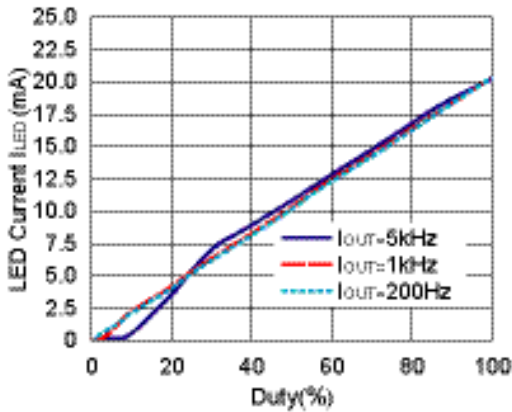

**9-2. Output Voltage Waveform (7 LED) (Ta = 25°C)**

R1218x072A

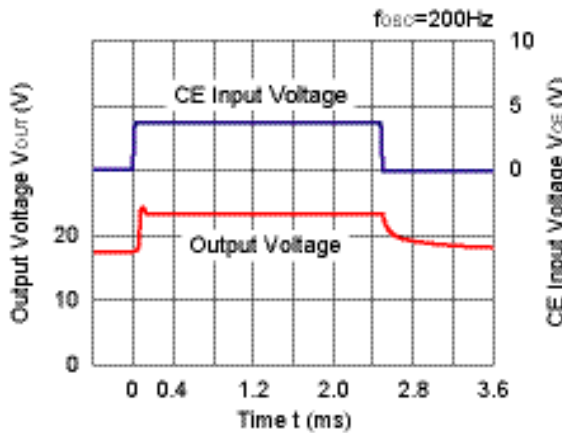

R1218x072A

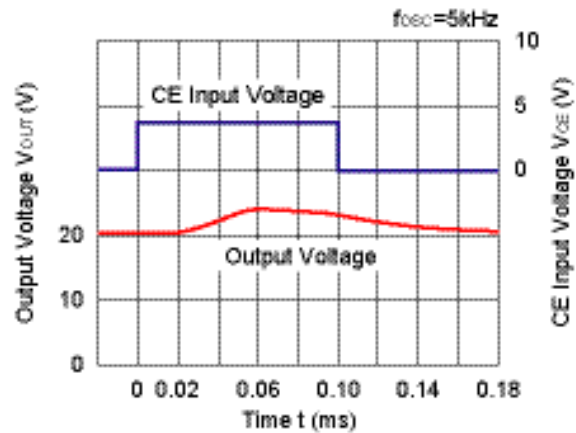

10)  $V_{FB}$  Voltage vs. Temperature

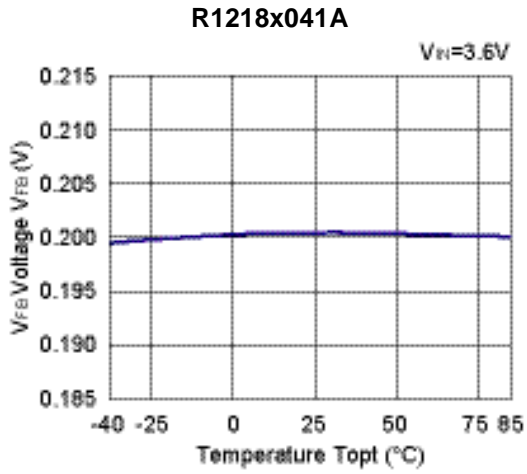

11) UVLO Detector Threshold/Released Voltage vs. Temperature

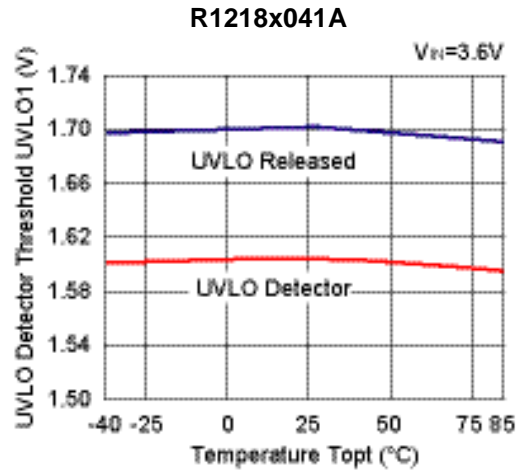

12) Oscillator Frequency vs. Temperature

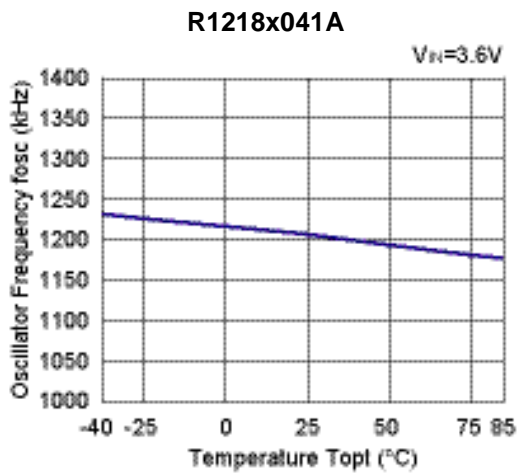

13) Maximum duty cycle vs. Temperature

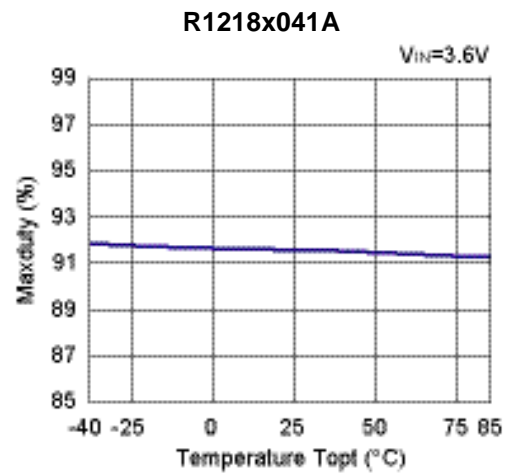

14) OVP Detector Threshold/Released Voltage vs. Temperature

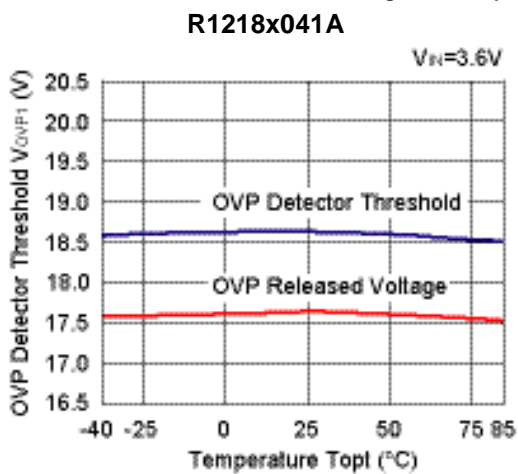

15) Supply Current vs. Temperature

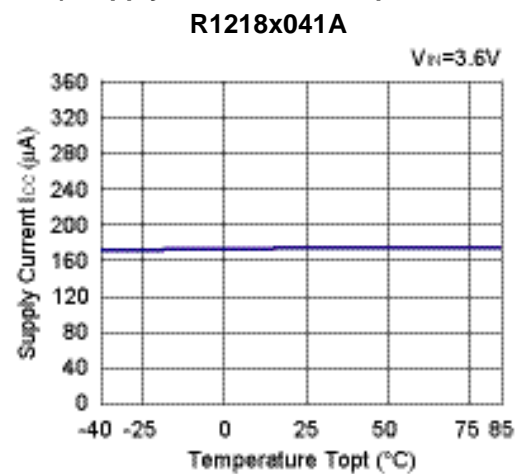

**R1218x**

No. EA-166-180704

**16) LX Current Limit vs. Temperature**

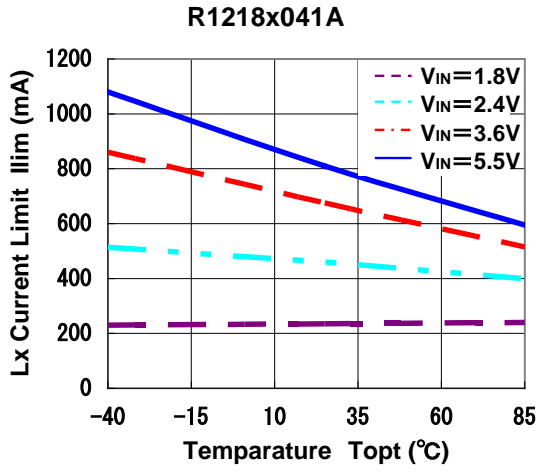

**17) OVP Transient Response (Ta = 25°C)**

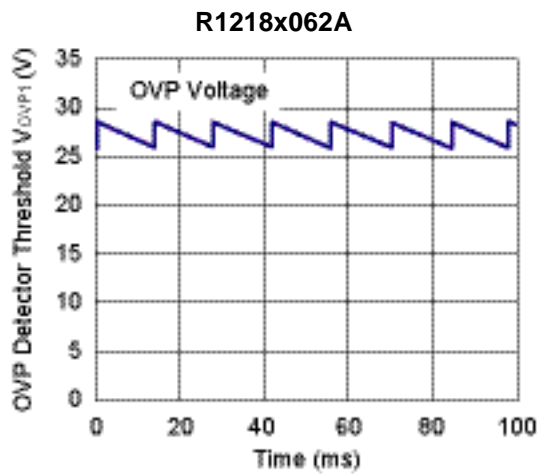
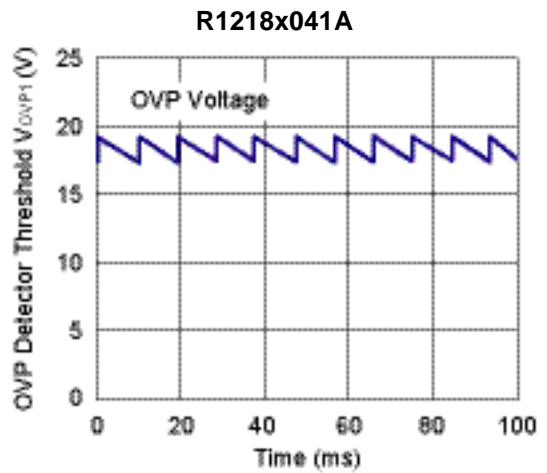
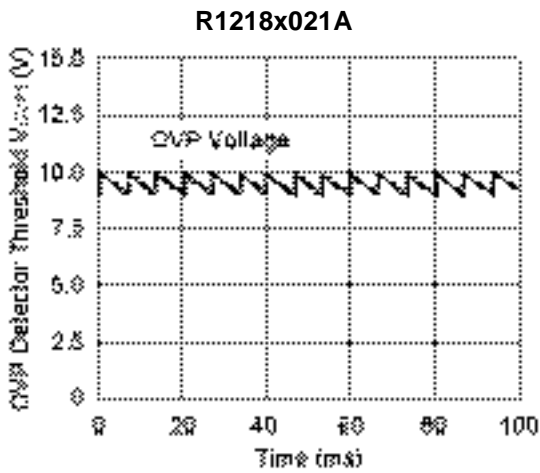

18) Efficiency dependence on inductors (4 LED)

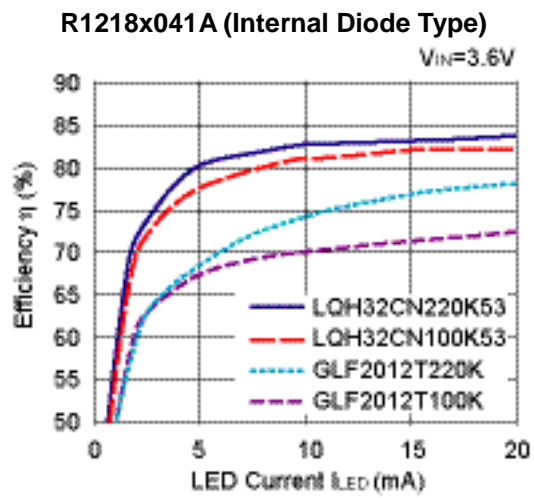



1. The products and the product specifications described in this document are subject to change or discontinuation of production without notice for reasons such as improvement. Therefore, before deciding to use the products, please refer to Ricoh sales representatives for the latest information thereon.
2. The materials in this document may not be copied or otherwise reproduced in whole or in part without prior written consent of Ricoh.
3. Please be sure to take any necessary formalities under relevant laws or regulations before exporting or otherwise taking out of your country the products or the technical information described herein.
4. The technical information described in this document shows typical characteristics of and example application circuits for the products. The release of such information is not to be construed as a warranty of or a grant of license under Ricoh's or any third party's intellectual property rights or any other rights.
5. The products listed in this document are intended and designed for use as general electronic components in standard applications (office equipment, telecommunication equipment, measuring instruments, consumer electronic products, amusement equipment etc.). Those customers intending to use a product in an application requiring extreme quality and reliability, for example, in a highly specific application where the failure or misoperation of the product could result in human injury or death (aircraft, spacevehicle, nuclear reactor control system, traffic control system, automotive and transportation equipment, combustion equipment, safety devices, life support system etc.) should first contact us.
6. We are making our continuous effort to improve the quality and reliability of our products, but semiconductor products are likely to fail with certain probability. In order to prevent any injury to persons or damages to property resulting from such failure, customers should be careful enough to incorporate safety measures in their design, such as redundancy feature, fire containment feature and fail-safe feature. We do not assume any liability or responsibility for any loss or damage arising from misuse or inappropriate use of the products.
7. Anti-radiation design is not implemented in the products described in this document.
8. The X-ray exposure can influence functions and characteristics of the products. Confirm the product functions and characteristics in the evaluation stage.
9. WLCSP products should be used in light shielded environments. The light exposure can influence functions and characteristics of the products under operation or storage.
10. There can be variation in the marking when different AOI (Automated Optical Inspection) equipment is used. In the case of recognizing the marking characteristic with AOI, please contact Ricoh sales or our distributor before attempting to use AOI.
11. Please contact Ricoh sales representatives should you have any questions or comments concerning the products or the technical information.



**Ricoh is committed to reducing the environmental loading materials in electrical devices with a view to contributing to the protection of human health and the environment.**

Ricoh has been providing RoHS compliant products since April 1, 2006 and Halogen-free products since April 1, 2012.

**RICOH** RICOH ELECTRONIC DEVICES CO., LTD.

**Official website**

<https://www.e-devices.ricoh.co.jp/en/>

**Contact us**

<https://www.e-devices.ricoh.co.jp/en/support/>

