

### PWM/ VFM Step-up DC/DC Converter for White LED Applications

NO.EA-327-170919

#### OUTLINE

The R1214Z is a low supply current PWM/ VFM step-up DC/DC converter. Internally, the device consists of an Nch MOSFET driver, an oscillator, a PWM comparator, a voltage reference unit, an error amplifier, an overcurrent protection circuit, an under voltage lockout circuit (UVLO), an overvoltage protection circuit (LxOVP, LEDOVP), a thermal shutdown protection circuit and 2-channel current drivers for white LEDs.

The R1214Z requires minimal external component count. By simply using an inductor, a resistor, capacitors and a diode, the white LEDs can be driven with constant current and high efficiency. The LED current can be determined by the value of current setting resistor. The brightness of the LEDs can be adjusted quickly by applying a 200 Hz to 300 kHz PWM signal to the PWM pin.

The R1214Z provides the PWM control or the PWM/VFM auto switching control. The PWM control switches at fixed frequency rate in low output current in order to reduce noise. Likewise, the PWM/VFM auto switching control automatically switches from PWM mode to VFM mode in low output current in order to achieve high efficiency. RICOH's unique control method can suppress a ripple voltage in the VFM mode, thus the R1214Z can achieve both low ripple voltage at light load and high efficiency.

The R1214Z provides an overcurrent protection circuit to limit the Lx peak current, an UVLO circuit to prevent the malfunction of the device at low input voltage, a LxOVP circuit to monitor the excess Lx voltage, a LEDOVP circuit to monitor the excess LED1-2 voltage and a thermal shutdown protection circuit to detect the overheating of the device and stops the operation to protect the device from damage.

The R1214Z is offered in a 9-pin WLCSP-9-P1 package.

#### FEATURES

- Input Voltage Range (Maximum Rating) ..... 2.7 V to 5.5 V (6.5 V)
- Supply Current ..... Typ. 500  $\mu$ A
- Standby Current..... Typ. 0.2  $\mu$ A, Max. 5  $\mu$ A
- Overcurrent Protection Circuit ..... Typ. 1.9 A
- Overvoltage Protection (OVP) Circuit..... Typ. 35 V
- LED1-2 Current Matching Circuit ..... Max. 0.5% (R1214Zxx1C/ D, 20 mA)  
Max. 1.0% (R1214Zxx1A/ B, 20 mA)
- Oscillator Frequency ..... Typ. 750 kHz/ 450 kHz
- Maximum Duty Cycle ..... Typ. 96% (R1214Zx11x)  
Typ. 94% (R1214Zx21x)
- Nch ON Resistance ..... Typ. 0.25  $\Omega$  ( $V_{IN} = 3.6$  V)
- Undervoltage Lockout (UVLO) Circuit ..... Typ. 2.4 V
- Thermal Shutdown Circuit ..... Typ. 150°C
- LED Dimming Control..... By sending a 200 Hz to 300 kHz PWM signal to the PWM pin
- Package..... WLCSP-9-P1

---

## R1214Z

---

NO.EA-327-170919

## APPLICATION

- White LED backlight driver for LCD displays for portable equipment
- White LED backlight driver for LCD displays for Smartphones, Tablets and Note PCs

## SELECTION GUIDE

The combinations of oscillator frequency, LED voltage and power controlling method are user-selectable options.

### Selection Guide

Product Name	Package	Quantity per Reel	Pb Free	Halogen Free
R1214Z2(y)1(z)-E2-F	WLCSP-9-P1	5,000 pcs	Yes	Yes

2(y)1(z)	(y): Oscillator Frequency	(z): LED Voltage (I <sub>LED</sub> = 20 mA)	(z): Power Controlling Method
211A	450 kHz	320 mV	PWM/ VFM Auto Switching
221A	750 kHz		
211B	450 kHz	320 mV	PWM
211C	450 kHz	600 mV	PWM/ VFM Auto Switching
221C	750 kHz		
211D	450 kHz	600 mV	PWM

# BLOCK DIAGRAMS

## R1214Z Block Diagram

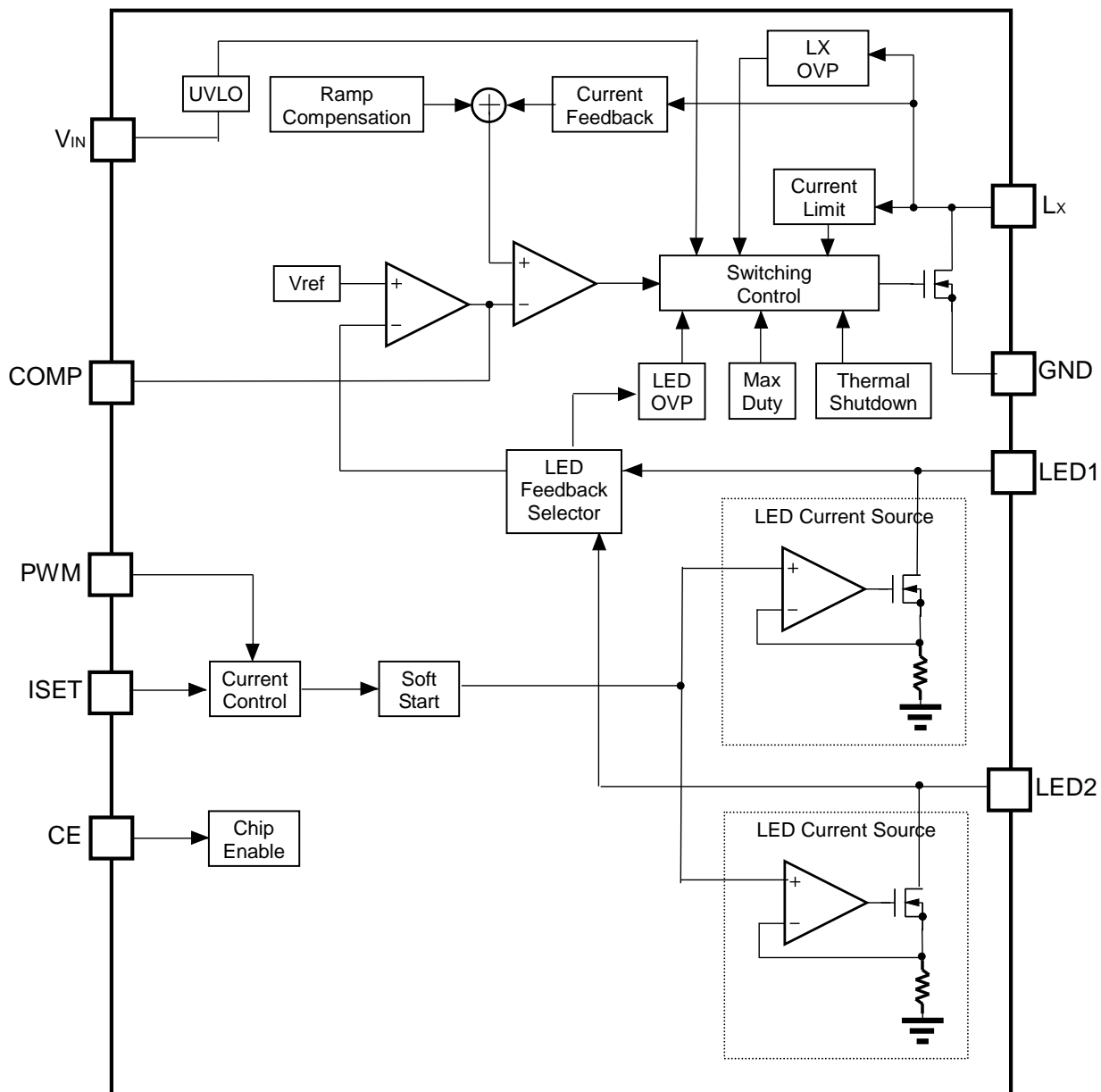

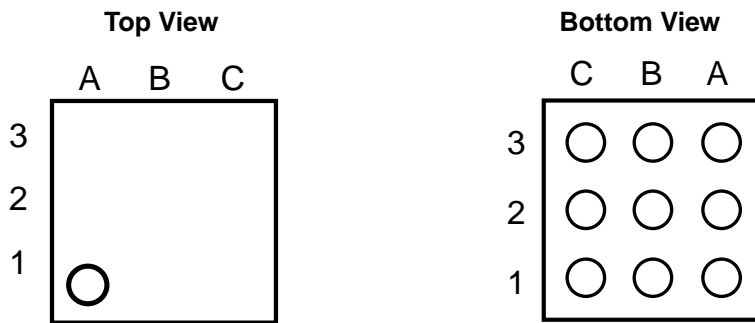
**PIN DESCRIPTION****WLCSP-9-P1 Pin Configurations****WLCSP-9-P1 Pin Description**

Pin No.	Symbol	Description
A1	ISET	LED Current Control Pin
A2	LED1	LED Current Supply Pin 1
A3	LED2	LED Current Supply Pin 2
B1	PWM	PWM Dimming Control Input Pin
B2	COMP	Error Amplifier Output Pin
B3	GND	Ground Pin
C1	CE	Chip Enable Pin, Active-high
C2	V <sub>IN</sub>	Analog Input Voltage Pin
C3	L <sub>x</sub>	Switching Pin, Open Drain Output

## ABSOLUTE MAXIMUM RATINGS

### Absolute Maximum Ratings

(GND = 0 V)

Symbol	Item	Rating	Unit
$V_{IN}$	$V_{IN}$ Pin Voltage	-0.3 to 6.5	V
$V_{CE}$	CE Pin Voltage	-0.3 to 6.5	V
$V_{ISET}$	ISET Pin Voltage	-0.3 to 6.5	V
$V_{COMP}$	COMP Pin Voltage	-0.3 to 6.5	V
$V_{LX}$	$L_X$ Pin Voltage <sup>(1)</sup>	-0.3 to 41.5	V
$V_{PWM}$	PWM Pin Voltage	-0.3 to 6.5	V
$V_{LED}$	LED1, LED2 Pin Voltage	-0.3 to 6.5	V
$P_D$	Power Dissipation (High Wattage Land Pattern) <sup>(2)</sup>	1190	mW
$T_j$	Junction Temperature Range	-40 to 125	°C
$T_{stg}$	Storage Temperature Range	-55 to 125	°C

### ABSOLUTE MAXIMUM RATINGS

Electronic and mechanical stress momentarily exceeded absolute maximum ratings may cause the permanent damages and may degrade the life time and safety for both device and system using the device in the field. The functional operation at or over these absolute maximum ratings are not assured.

## RECOMMENDED OPERATING CONDITONS

Symbol	Item	Rating	Unit
$V_{IN}$	Input Voltage	2.7 to 5.5	V
$T_a$	Operating Temperature Range	-40 to 85	°C

### RECOMMENDED OPERATING CONDITIONS

All of electronic equipment should be designed that the mounted semiconductor devices operate within the recommended operating conditions. The semiconductor devices cannot operate normally over the recommended operating conditions, even if when they are used over such ratings by momentary electronic noise or surge. And the semiconductor devices may receive serious damage when they continue to operate over the recommended operating conditions.

<sup>(1)</sup> Constantly applying a constant-voltage higher than 6.5 V to the  $L_X$  pin from the outside may cause the permanent damages to the device.

<sup>(2)</sup> Refer to *POWER DISSIPATION* for detailed information.

## R1214Z

NO.EA-327-170919

## ELECTRICAL CHARACTERISTICS

The specifications surrounded by  are over  $-40^{\circ}\text{C} \leq T_a \leq 85^{\circ}\text{C}$ . and guaranteed by design engineering.

### R1214Z Electrical Characteristics

( $T_a = 25^{\circ}\text{C}$ )

Symbol	Item	Conditions	Min.	Typ.	Max.	Unit	
$I_{DD}$	Supply Current	$V_{IN} = 3.6\text{ V}$ , no load, non-switching		0.5		mA	
$I_{standby}$	Standby Current	$V_{IN} = 5.5\text{ V}$ , $V_{CE} = 0\text{ V}$		0.2	5.0	$\mu\text{A}$	
$V_{UVLO1}$	UVLO Detector Threshold	$V_{IN}$ falling	2.25	2.4		V	
$V_{UVLO2}$	UVLO Released Voltage	$V_{IN}$ rising		$V_{UVLO1} + 0.1$	2.65	V	
$V_{CEH}$	CE Input Voltage "H"	$V_{IN} = 5.5\text{ V}$	1.5			V	
$V_{CEL}$	CE Input Voltage "L"	$V_{IN} = 2.7\text{ V}$			0.4	V	
$R_{CE}$	CE Pull-down Resistance	$V_{IN} = 5.5\text{ V}$		1200		K $\Omega$	
$R_{PWM}$	PWM Pull-down Resistance	$V_{IN} = 5.5\text{ V}$		1200		K $\Omega$	
$I_{LED}$	LED1-2 Current Accuracy	$R_{ISET} = 30.1\text{ k}\Omega$ (1 string = 20 mA) $V_{IN} = 3.6\text{ V}$	R1214Zxx1A/ B	19.6	20	20.4	mA
			R1214Zxx1C/ D	19.7	20	20.3	
$I_{LEDM1}$	LED1-2 Current Matching Accuracy 1 (1 string = 20 mA)	$R_{ISET} = 30.1\text{ k}\Omega$ PWMduty = 100% $V_{IN} = 3.6\text{ V}$ $(I_{MAX} - I_{Ave}^{(3)}) / I_{Ave}$	R1214Zxx1A/ B		0.2	1.0	%
			R1214Zxx1C/ D		0.1	0.5	
$I_{LEDM2}$	LED1-2 Current Matching Accuracy 2 (1 string = 20 mA)	$R_{ISET} = 30.1\text{ k}\Omega$ PWMduty = 10% ( $f_{PWM} = 20\text{ kHz}$ ) $V_{IN} = 3.6\text{ V}$ $(I_{MAX} - I_{Ave}) / I_{Ave}$	R1214Zxx1A/ B		0.5		%
			R1214Zxx1C/ D		0.3		
$I_{LEDMAX}$	LED1-2 Maximum Current at 100% Dimming Range	$V_{IN} = 3.6\text{ V}$	<span style="border: 1px solid black; padding: 0 2px;">40</span>			mA	
$I_{LEDLEAK}$	LED1-2 Leakage Current	$V_{IN} = 5.5\text{ V}$ , $V_{LED1-2} = 1\text{ V}$ , $V_{CE} = 0\text{ V}$			3.0	$\mu\text{A}$	
$R_{ON}$	Nch ON Resistance	$V_{IN} = 3.6\text{ V}$ , $I_{LX} = 100\text{ mA}$		0.25		$\Omega$	
$I_{LXLEAK}$	Lx Leakage Current	$V_{IN} = 5.5\text{ V}$ , $V_{LX} = 41\text{ V}$			3.0	$\mu\text{A}$	
$I_{LXLIM}$	Lx Current Limit	$V_{IN} = 3.6\text{ V}$	1.3	1.9	2.5	A	
$V_{LED}$	LED1-2 Regulated Voltage	R1214Zxx1A/ B (1 string = 20 mA), $V_{IN} = 3.6\text{ V}$		320		mV	
		R1214Zxx1C/ D (1 string = 20 mA), $V_{IN} = 3.6\text{ V}$		600			
$f_{osc}$	Oscillator Frequency	R1214Zx11x, $V_{IN} = 3.6\text{ V}$	400	450	500	kHz	
		R1214Zx21x, $V_{IN} = 3.6\text{ V}$	675	750	825		

<sup>(3)</sup>  $I_{Ave}$  is the average current of LED1-2.

## ELECTRICAL CHARACTERISTICS (continued)

The specifications surrounded by  are over  $-40^{\circ}\text{C} \leq T_a \leq 85^{\circ}\text{C}$ . and guaranteed by design engineering.

### R1214Z Electrical Characteristics

( $T_a = 25^{\circ}\text{C}$ )

Symbol	Item	Conditions	Min.	Typ.	Max.	Unit	
Maxduty	Maximum Duty Cycle	R1214Zx11x, $V_{IN} = 3.6\text{ V}$	92	96		%	
		R1214Zx21x, $V_{IN} = 3.6\text{ V}$	91	94			
$V_{OVP1}$	$V_{LX}$ OVP Detector Threshold	$V_{OUT}$ rising $V_{IN} = 3.6\text{ V}$	R1214Z2x1x	29	35	41	V
$V_{OVP2}$	$V_{LED}$ OVP Detector Threshold	$V_{LED1-2}$ rising, $V_{IN} = 3.6\text{ V}$		4.3	4.5	4.7	V
tstart	Soft Start Time	$V_{IN} = 3.6\text{ V}$		15		ms	
$T_{TSD}$	Thermal Shutdown Temperature	$V_{IN} = 3.6\text{ V}$		150		$^{\circ}\text{C}$	
$T_{TSR}$	Thermal Shutdown Release Temperature	$V_{IN} = 3.6\text{ V}$		125		$^{\circ}\text{C}$	

All test items listed under ELECTRICAL CHARACTERISTICS are done under the pulse load condition ( $T_j \approx T_a = 25^{\circ}\text{C}$ ) except LED1-2 Current max at 100% Dimming Range.

## THEORY OF OPERATION

### Soft-Start

During start-up, soft-start increases the output voltage ( $V_{OUT}$ ) by forcibly switching the  $L_x$  pin and gradually increasing the  $L_x$  current limit ( $I_{LxLIM}$ ). If the preset LED current is 1.5 mA or more, soft-start gradually increases the LED current ( $I_{LED}$ ) until it reaches the preset LED current. If the preset LED current is less than 1.5 mA, soft-start increases  $I_{LED}$  until it reaches 1.5 mA, then reduces it to the preset LED current. To minimize the overshoot of  $I_{LED}$ , a 1- $\mu$ F capacitor ( $C4$ ) can be used.

### Overcurrent Protection

If the peak inductor current ( $I_{Lmax}$ ) exceeds  $I_{LxLIM}$ , overcurrent protection turns the driver off and turns it on in every switching cycle to continually monitor the driver current.

### Overvoltage Protection (OVP)

The flow chart below illustrates the functions of  $L_x$ OVP and LEDOVP.  $L_x$ OVP protects the device from high voltage due to the disconnection of white LED string. To release the latch-type  $L_x$ OVP or LEDOVP, set the CE pin low or decrease the  $V_{IN}$  pin voltage below the UVLO detector threshold.

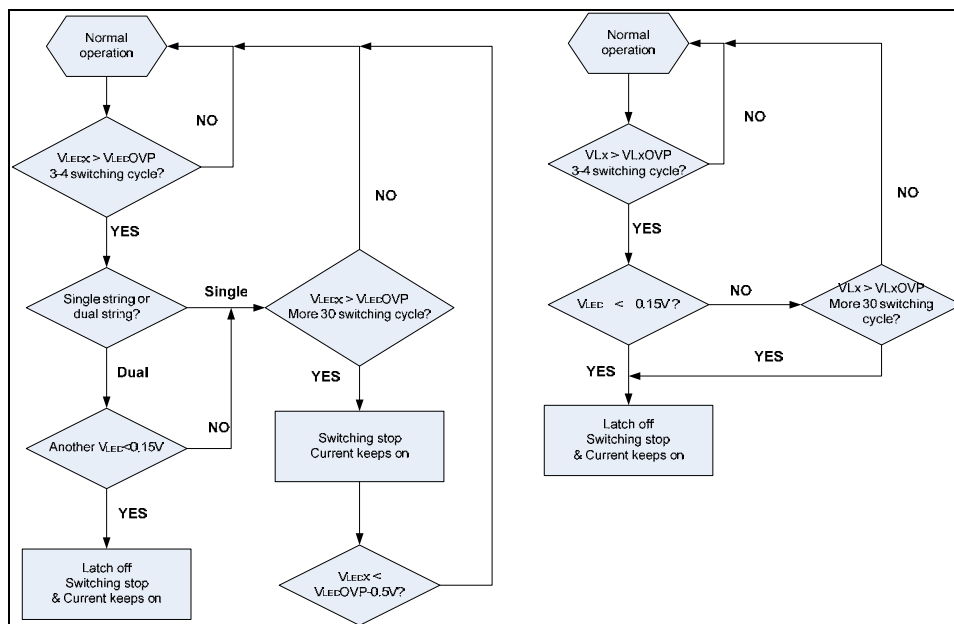

LxOVP and LEDOVP Function Flow

### Under Voltage Lockout (UVLO)

UVLO stops the device operation to prevent malfunction when the input ( $V_{IN}$ ) voltage falls below the UVLO detector threshold.



## Thermal Shutdown

Thermal shutdown circuit detects overheating of the converter and stops the device operation to protect it from damage. If the junction temperature of the device exceeds the specified temperature, the thermal shutdown stops the device operation and resumes the device operation if the junction temperature decreases below the thermal shutdown release temperature.

## Input Signal Sequencing

The timing of turning on or off of LEDs can be controlled by sequencing the input signals. There are two ways of sequencing the input signals:

### Sequencing 1. Send a signal to the PWM pin first and then switch the CE pin to high.

The device shifts from standby mode to active mode to turn the LEDs on.

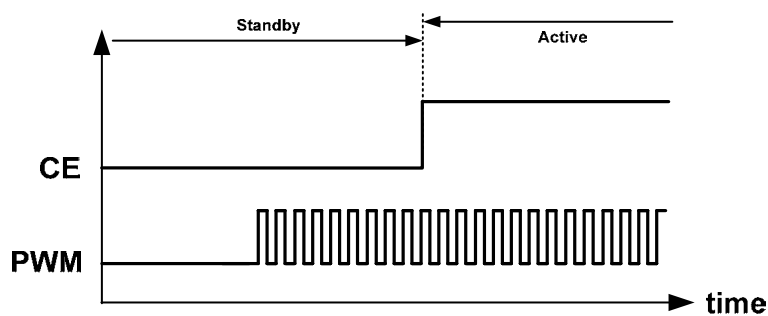

Sequencing 1 Diagram

### Sequencing 2. Send a signal to the PWM pin while the CE pin is constantly set high.

The device shifts from standby mode to active mode to turn the LEDs on. If a signal is not sent to the PWM pin more than 50 ms (Max.), the device shifts from active mode to standby mode to turn the LEDs off.

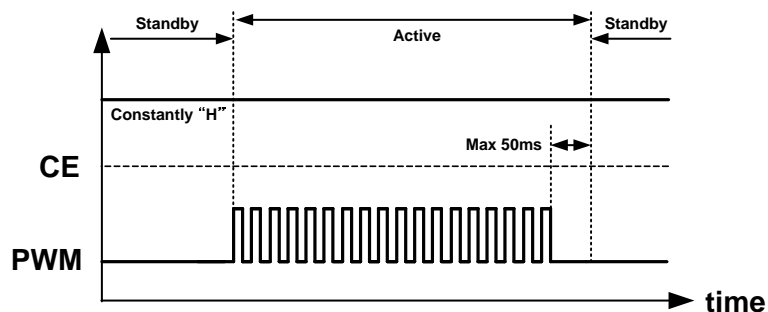

Sequencing 2 Diagram

---

## R1214Z

---

NO.EA-327-170919

### LED Dimming Control

The brightness of the LEDs can be adjusted by applying a PWM signal to the PWM pin. The LED current ( $I_{LED}$ ) can be controlled by the duty of a PWM signal for the PWM pin. The duty range of a PWM signal can be set in a range of 0.4% to 100% when using a 1- $\mu$ F capacitor ( $C_4$ ) and a 30.1-k $\Omega$  feedback resistor ( $R_{ISET}$ ). The relation between the high-duty of the PWM pin ( $Hduty$ ) and  $I_{LED}$  can be calculated as follows:

$$I_{LED} = Hduty \times I_{LEDSET}$$

The frequency of a PWM signal for dimming the LEDs can be set within the range of 200 Hz to 300 kHz; however, it is recommended that a 20-kHz to 100-kHz frequency be used. In the case of using a less than 20-kHz PWM signal, an increase or decrease in an inductor current ( $I_L$ ) may generate noise in the audible band. To avoid this, connect a 2.2- $\mu$ F or more capacitor ( $C_3$ ) between the ISET pin and GND pin. In the case of using a 20-kHz or more PWM signal,  $C_3$  is not required. Note that if a PWM signal is changed stepwise, a change in the LED luminance level can be visible as shown in the following figure. To reduce the visible change in the LED luminance level,  $C_3$  can also be used.

#### Reducing the visible change in LED luminance level by using $C_3$

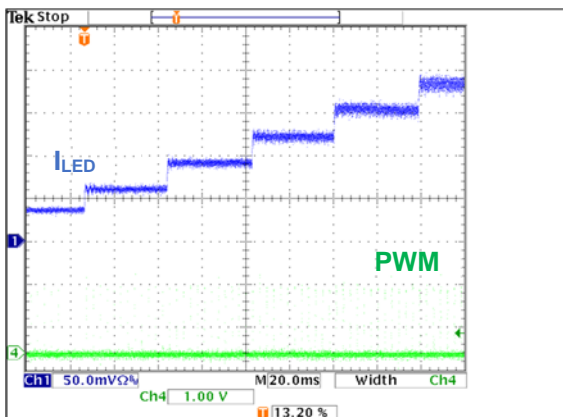

$C_3 = 0 \mu\text{F}$

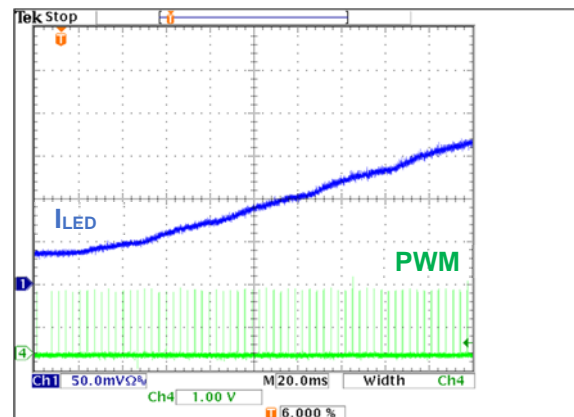

$C_3 = 2.2 \mu\text{F}$

### White LED Current Setting

The LED current for each LED string when a PWM signal applied to the PWM pin is Duty = 100% ( $I_{LEDSET}$ ) can be determined by the value of feedback resistor ( $R_{ISET}$ ).  $I_{LEDSET}$  can be calculated as follows:

$$I_{LEDSET} = 0.0466 \times R_{ISET} / (40 \text{ k} + R_{ISET})$$

$R_{ISET}$  should be set to 19 k $\Omega$  or more. If  $R_{ISET}$  with 30.1 k $\Omega$  is placed between the ISET and GND pins,  $I_{LEDSET}$  will be set to 20 mA.

**Operation of Step-Up Dc/Dc Converter And Output Current**

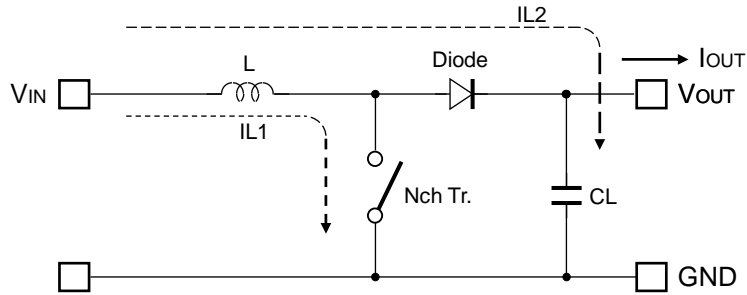

**Basic Circuit**

**Inductor Current (IL) Waveform**

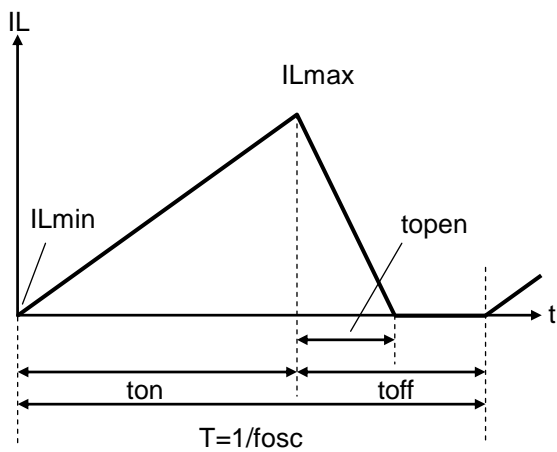

**Discontinuous Inductor Current Mode**

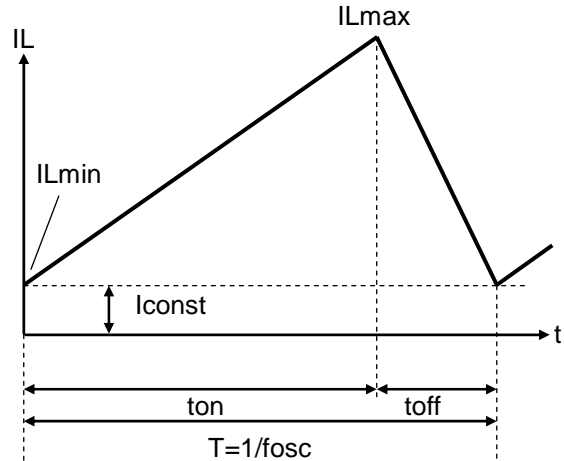

**Continuous Inductor Current Mode**

The PWM control type of the step-up DC/DC converter has two operation modes characterized by the continuity of inductor current: discontinuous inductor current mode and continuous inductor current mode.

When an Nch transistor is in On-state, the voltage to be applied to the inductor (L) is described as  $V_{IN}$ . An increase in the inductor current ( $I_{L1}$ ) can be written as follows:

$$I_{L1} = V_{IN} \times t_{on} / L \dots\dots\dots \text{Equation 1}$$

In the step-up DC/DC converter circuit, the energy accumulated during the On-state is transferred into the capacitor even in the Off-state. A decrease in the inductor current ( $I_{L2}$ ) can be written as follows:

$$I_{L2} = (V_{OUT} - V_{IN}) \times t_{open} / L \dots\dots\dots \text{Equation 2}$$

---

**R1214Z**

---

NO.EA-327-170919

In the PWM control, IL1 and IL2 become continuous when  $t_{open} = t_{off}$ , which is called continuous inductor current mode.

When the device is in continuous inductor current mode and operates in steady-state conditions, the variations of IL1 and IL2 are same:

$$V_{IN} \times t_{on} / L = (V_{OUT} - V_{IN}) \times t_{off} / L \dots\dots\dots \text{Equation 3}$$

Therefore, the duty cycle in continuous inductor current mode is:

$$\text{duty (\%)} = t_{on} / (t_{on} + t_{off}) = (V_{OUT} - V_{IN}) / V_{OUT} \dots\dots\dots \text{Equation 4}$$

When  $t_{open} = t_{off}$ , the average of IL1 is:

$$IL1 (\text{Ave.}) = V_{IN} \times t_{on} / (2 \times L) \dots\dots\dots \text{Equation 5}$$

If the input voltage ( $V_{IN}$ ) is equal to the output voltage ( $V_{OUT}$ ), the output current ( $I_{OUT}$ ) is:

$$I_{OUT} = V_{IN}^2 \times t_{on} / (2 \times L \times V_{OUT}) \dots\dots\dots \text{Equation 6}$$

If  $I_{OUT}$  is larger than Equation 6, the device switches to continuous inductor current mode

The peak inductor current ( $IL_{max}$ ) is:

$$IL_{max} = I_{OUT} \times V_{OUT} / V_{IN} + V_{IN} \times t_{on} / (2 \times L) \dots\dots\dots \text{Equation 7}$$

$$IL_{max} = I_{OUT} \times V_{OUT} / V_{IN} + V_{IN} \times T \times (V_{OUT} - V_{IN}) / (2 \times L \times V_{OUT}) \dots\dots\dots \text{Equation 8}$$

As a result,  $IL_{max}$  becomes larger compared to  $I_{OUT}$ . The overcurrent protection circuit operates if the  $IL_{max}$  becomes more than the  $L_x$  current limit. When considering the input and output conditions or selecting the external components, please pay attention to  $IL_{max}$ .

**Notes:** The above calculations are based on the ideal operation of the device. They do not include the losses caused by the external components or Nch transistor. The actual maximum output current will be 50% to 80% of the above calculation results. Especially, if  $IL$  is large or  $V_{IN}$  is low, it may cause the switching losses. An approximately 0.8 V forward voltage ( $V_F$ ) of diode should be added to  $V_{OUT}$  in the above calculations.

## APPLICATION INFORMATION

### Typical Application Circuits

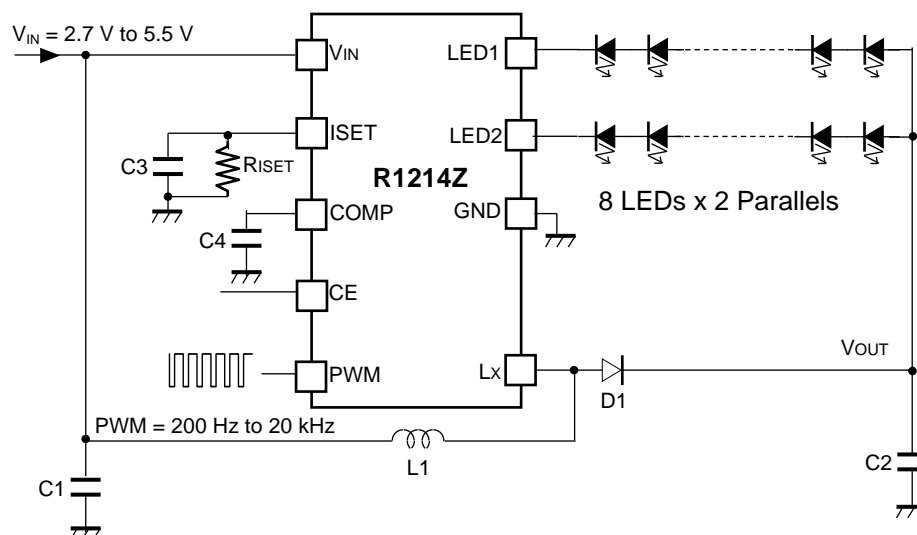

Typical Application: 8 LEDs in series x 2 parallels, 200 Hz to 20 kHz PWM signal

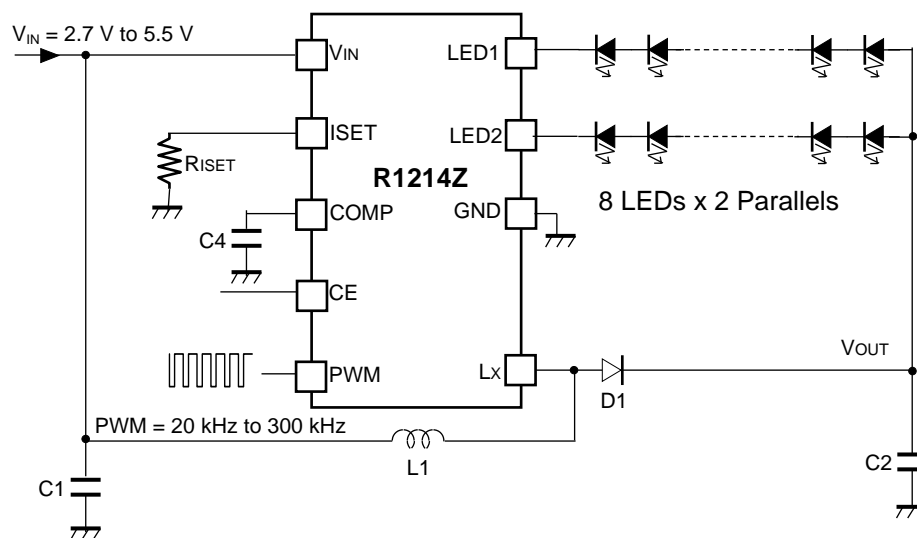

Typical Application: 8 LEDs in series x 2 parallels, 20 kHz to 300 kHz PWM signal

## R1214Z

NO.EA-327-170919

### Recommended Inductors

L1 (μH)	Product Name	Rated Current (mA)	Inductor Size (mm)	Components No.
10	R1214Z221x (750 kHz)	550	2.5 x 2.0 x 1.0	VLS252010ET-100M
10		620	3.0 x 2.5 x 1.2	VLF302512MT-100M
10		900	4.0 x 3.2 x 1.2	VLF403212MT-100M
10		1320	5.0 x 4.0 x 1.2	VLF504012MT-100M
22	R1214Z211x (450 kHz)	430	3.0 x 2.5 x 1.2	VLF302512MT-220M
22		540	4.0 x 3.2 x 1.2	VLF403212MT-220M
22		890	5.0 x 4.0 x 1.2	VLF504012MT-220M

### Recommended Components

Symbol	Description	Rated Voltage (V)	Value	Components No.
C1 (C <sub>IN</sub> )	Ceramic Capacitor	6.3	4.7 μF or more	C1608JB0J475K
C2 (C <sub>OUT</sub> )	Ceramic Capacitor	50	2.2 μF or more R1214Z211x	C2012X5R1H225K
			1.0 μF or more R1214Z221x	C2012X5R1H105K
C3	Ceramic Capacitor	6.3	2.2 μF or more	-
C4	Ceramic Capacitor	6.3	0.1 μF to 1μF	-
D1	Diode	60	-	CRS12
		60	-	RB060M-60

### Cautions in Selecting External Components

#### Selection of Inductor

The peak inductor current (I<sub>Lmax</sub>) under steady operation can be calculated as follows:

$$I_{Lmax} = 1.25 \times I_{LED} \times V_{OUT} / V_{IN} + 0.5 \times V_{IN} \times (V_{OUT} - V_{IN}) / (L \times V_{OUT} \times f_{osc})$$

When starting up the device or adjusting the brightness of LED lights using the PWM pin, a large transient current may flow into an inductor (L1). I<sub>Lmax</sub> should be equal or smaller than the L<sub>x</sub> current limit (I<sub>LXLIM</sub>) of the device. It is recommended that a 10 μH to 22 μH inductor be used.

### Selection of Capacitor

Set a 4.7  $\mu\text{F}$  or more input capacitor (C1) between the  $V_{\text{IN}}$  and GND pins as close as possible to the pins.

Set a 2.2  $\mu\text{F}$  or more output capacitor (C2) between the  $V_{\text{OUT}}$  and GND pins for R1214Zx11x.

Set a 1  $\mu\text{F}$  or more output capacitor (C2) between the  $V_{\text{OUT}}$  and GND pins for R1214Zx21x.

If a PWM input signal is within the range of 200 Hz to 20 kHz, set a 2.2  $\mu\text{F}$  or more capacitor (C3) between the ISET and GND pins. If a PWM input signal is within the range of 20 kHz to 300 kHz, a capacitor (C3) is not required. Set a capacitor (C4) 0.1  $\mu\text{F}$  between the COMP and GND pins.

### Selection of SBD (Schottky Barrier Diode)

Choose a diode that has low forward voltage ( $V_{\text{F}}$ ), low reverse current ( $I_{\text{R}}$ ), and low parasitic capacitance.

SBD is an ideal type of diode for R1214Z since it has low  $V_{\text{F}}$ , low  $I_{\text{R}}$ , and low parasitic capacitance.

## TECHNICAL NOTES

The performance of a power source circuit using this device is highly dependent on a peripheral circuit. A peripheral component or the device mounted on PCB should not exceed a rated voltage, a rated current or a rated power. When designing a peripheral circuit, please be fully aware of the following points.

- Place an input capacitor (C1) between the  $V_{\text{IN}}$  pin and the GND pin as close as possible. Also, connect the GND pin to the wider plane.
- Make the  $L_{\text{x}}$  land pattern as small as possible.
- Make the wirings between the  $L_{\text{x}}$  pin, the inductor and the diode as short as possible. Also, connect an output capacitor (C2) as close as possible to the cathode of the diode.
- Place C2 as close as possible to the GND pin.
- Unused LED pin should be connected to GND.
- Figure 1 and Figure 2 show the current pathways of application circuits when MOSFET is turned ON or when MOSFET is turned OFF, respectively. As shown in Figure 1 and Figure 2, the currents flow in the directions of blue or green arrows. The parasitic components, such as impedance, inductance or capacitance, formed in the pathways indicated by the red arrows affect the stability of the system and become the cause of noise. Reduce the parasitic components as much as possible. The current pathways should be made by short and thick wirings.

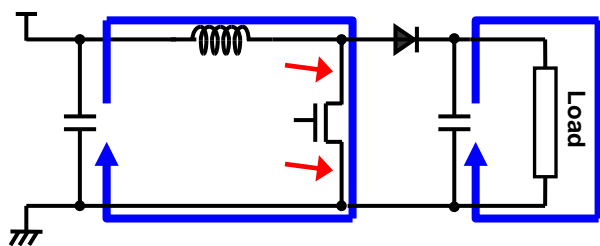

Figure 1. MOSFET-ON

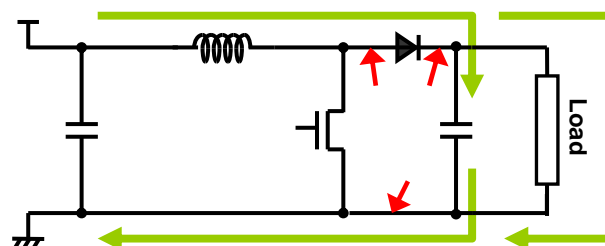

Figure 2. MOSFET-OFF

---

## R1214Z

---

NO.EA-327-170919

### Reference PCB Layouts

#### R1214Z (WLCSP-9-P1) PCB Layout

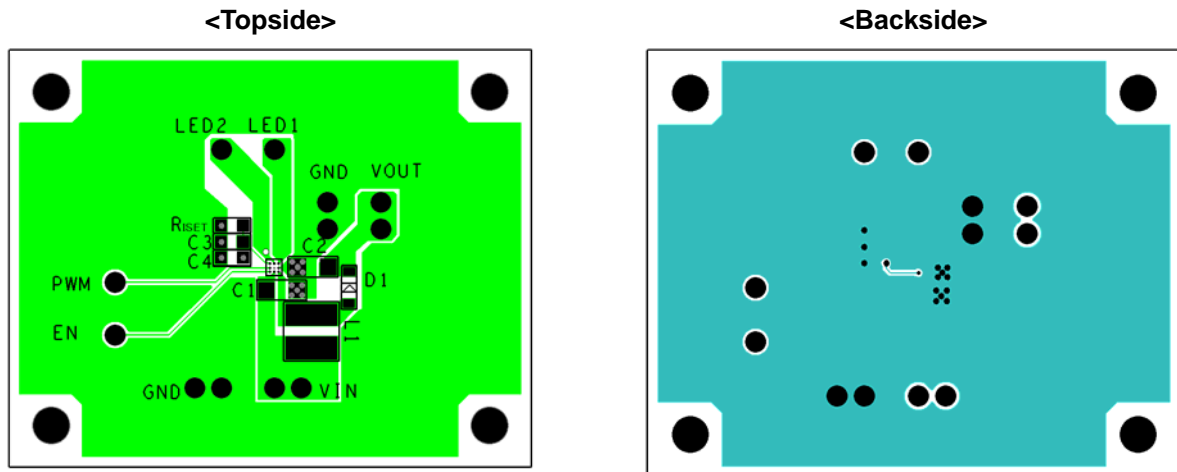



## TYPICAL CHARACTERISTICS

Note: Typical Characteristics are intended to be used as reference data; they are not guaranteed.

### 1) Efficiency vs. Output Current

#### 1-1) Efficiency of R1214Z211A with Different Input Voltages

VLF403012-100M/ 6s2p LEDs

(V<sub>OUT</sub> = 16.9 V at 40 mA per 1 String)

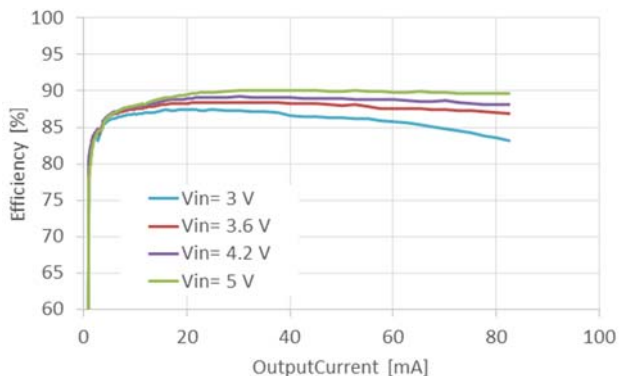

VLF403012-220M/ 6s2p LEDs

(V<sub>OUT</sub> = 16.9 V at 40 mA per 1 String)

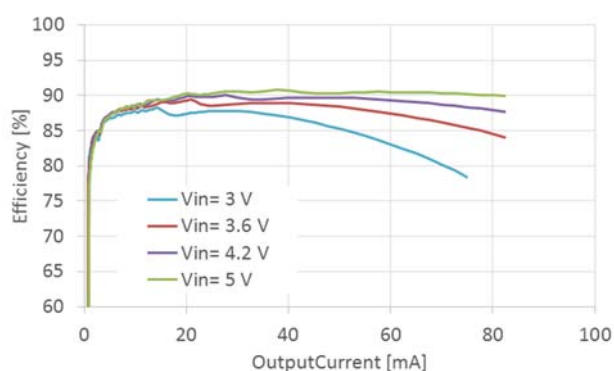

VLF403012-100M/ 8s2p LEDs

(V<sub>OUT</sub> = 22.3 V at 40 mA per 1 String)

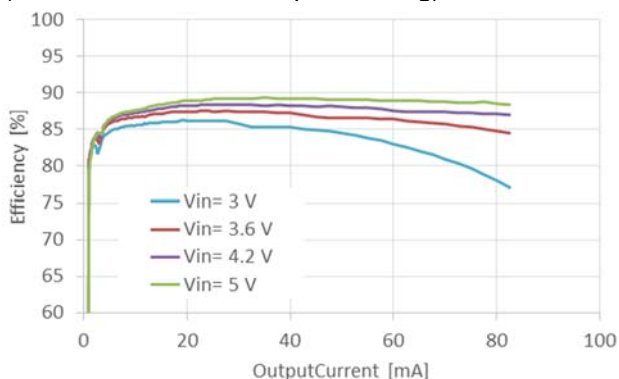

VLF403012-220M/ 8s2p LEDs

(V<sub>OUT</sub> = 22.3 V at 40 mA per 1 String)

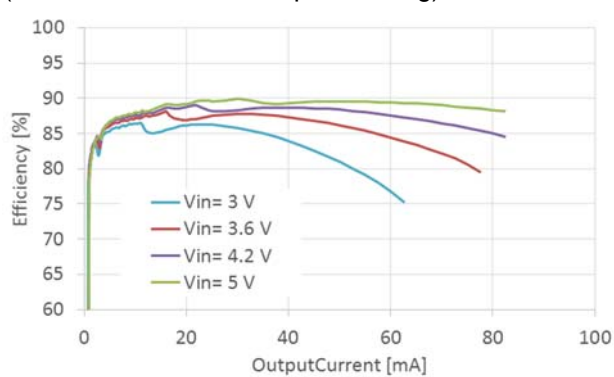

#### 1-2) Efficiency of R1214Z211A with Different Inductors (V<sub>OUT</sub> = 28 V at 80 mA)

V<sub>IN</sub> = 3.6 V/ 6s2p LEDs

(V<sub>OUT</sub> = 16.9 V at 40 mA per 1 String)

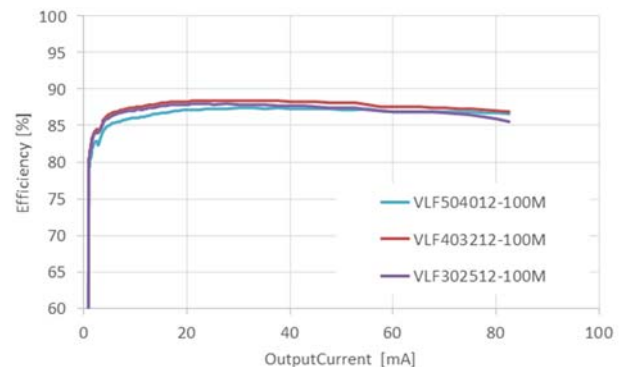

V<sub>IN</sub> = 3.6 V/ 6s2p LEDs

(V<sub>OUT</sub> = 16.9 V at 40 mA per 1 String)

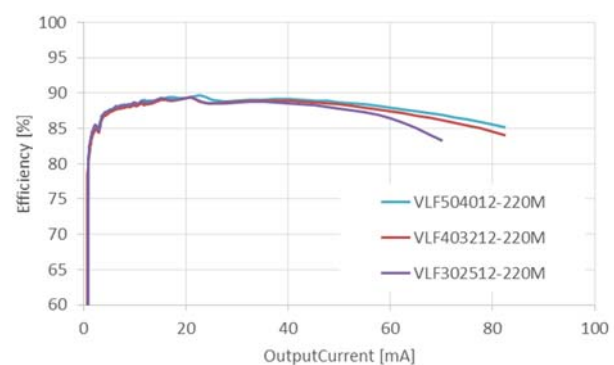

# R1214Z

NO.EA-327-170919

$V_{IN} = 3.6\text{ V}$  / 8s2p LEDs  
 ( $V_{OUT} = 22.3\text{ V}$  at 40 mA per 1 String)

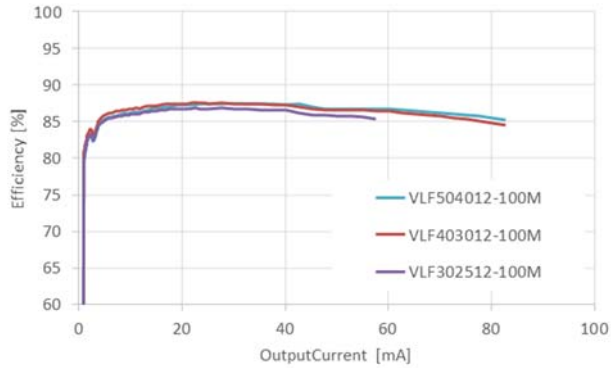

$V_{IN} = 3.6\text{ V}$  / 8s2p LEDs  
 ( $V_{OUT} = 22.3\text{ V}$  at 40 mA per 1 String)

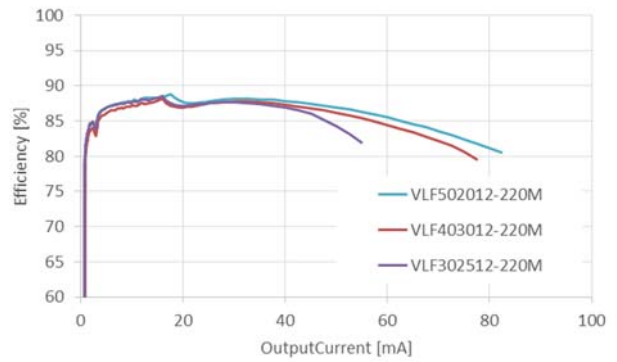

## 2) PWM Dimming Duty vs. $I_{LED}$ ( $R_{ISET} = 30.1\text{ k}\Omega$ )

$V_{IN} = 3.6\text{ V}$  / 8s2p LEDs  
 ( $f_{PWM} = 20\text{ kHz}$ )  
 ( $R_{ISET} = 30.1\text{ k}\Omega$ )

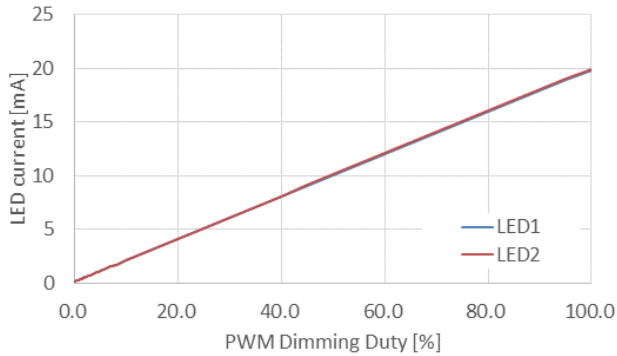

$V_{IN} = 3.6\text{ V}$  / 8s2p LEDs  
 ( $f_{PWM} = 20\text{ kHz}$ )  
 ( $R_{ISET} = 30.1\text{ k}\Omega$ )

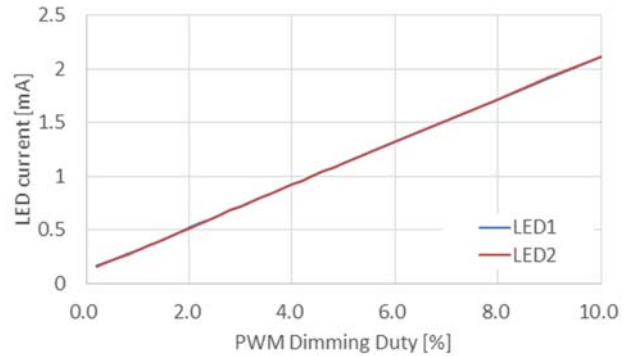

## 3) $I_{LED}$ Waveform in the VFM Mode

$V_{IN} = 3.6\text{ V}$  / 8s2p LEDs  
 R1214Z221A ( $f_{PWM} = 10\text{ kHz}$ , PWMduty = 10%)  
 ( $R_{ISET} = 30.1\text{ k}\Omega$ )

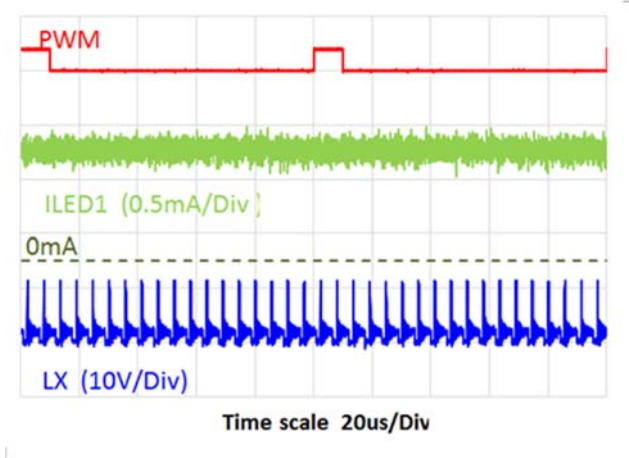

$V_{IN} = 3.6\text{ V}$  / 8s2p LEDs  
 R1214Z221A ( $f_{PWM} = 10\text{ kHz}$ , PWMduty = 10%)  
 ( $R_{ISET} = 30.1\text{ k}\Omega$ )

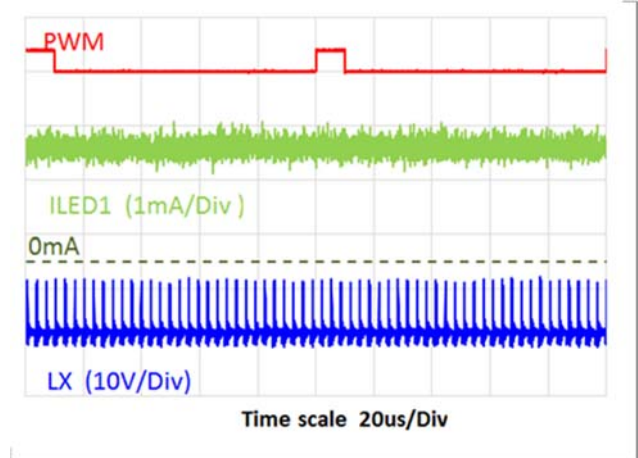

**4) Startup/ Shutdown Waveform**

$V_{IN} = 3.6\text{ V}$  / 8s2p LEDs  
 R1214Zxxxx ( $f_{PWM} = 20\text{ kHz}$ , PWMduty = 50%)  
 ( $R_{ISET} = 30.1\text{ k}\Omega$ )



$V_{IN} = 3.6\text{ V}$  / 8s2p LEDs  
 R1214Zxxxx ( $f_{PWM} = 20\text{ kHz}$ , PWMduty = 50%)  
 ( $R_{ISET} = 30.1\text{ k}\Omega$ )



$V_{IN} = 3.6\text{ V}$  / 8s2p LEDs  
 R1214Zxxxx ( $f_{PWM} = 20\text{ kHz}$ , PWMduty = 100%)  
 ( $R_{ISET} = 30.1\text{ k}\Omega$ )



$V_{IN} = 3.6\text{ V}$  / 8s2p LEDs  
 R1214Zxxxx ( $f_{PWM} = 20\text{ kHz}$ , PWMduty = 100%)  
 ( $R_{ISET} = 30.1\text{ k}\Omega$ )



# R1214Z

NO.EA-327-170919

## 5) Load Transient Response

$V_{IN} = 3.6\text{ V} / 8\text{s}2\text{p LEDs}$

R1214Z221A ( $f_{PWM} = 20\text{ kHz}$ ,  $PWM\text{duty} = 10\% \rightarrow 90\%$ )  
 ( $R_{ISET} = 30.1\text{ k}\Omega / C_{ISET} = 0\text{ }\mu\text{F}$ )

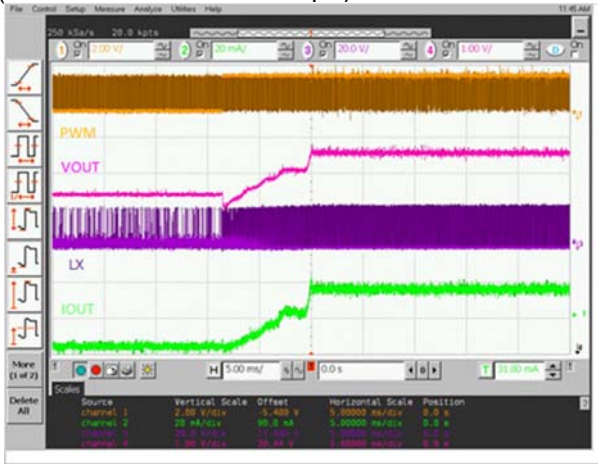

$V_{IN} = 3.6\text{ V} / 8\text{s}2\text{p LEDs}$

R1214Z221A ( $f_{PWM} = 20\text{ kHz}$ ,  $PWM\text{duty} = 90\% \rightarrow 10\%$ )  
 ( $R_{ISET} = 30.1\text{ k}\Omega / C_{ISET} = 0\text{ }\mu\text{F}$ )

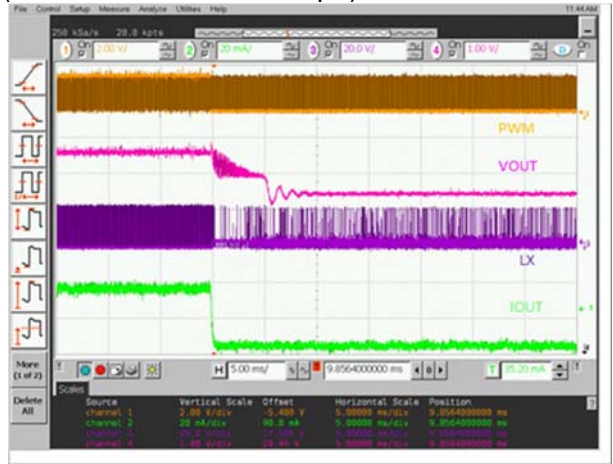

$V_{IN} = 3.6\text{ V} / 8\text{s}2\text{p LEDs}$

R1214Z221A ( $f_{PWM} = 20\text{ kHz}$ ,  $PWM\text{duty} = 10\% \rightarrow 90\%$ )  
 ( $R_{ISET} = 30.1\text{ k}\Omega / C_{ISET} = 2.0\text{ }\mu\text{F}$ )

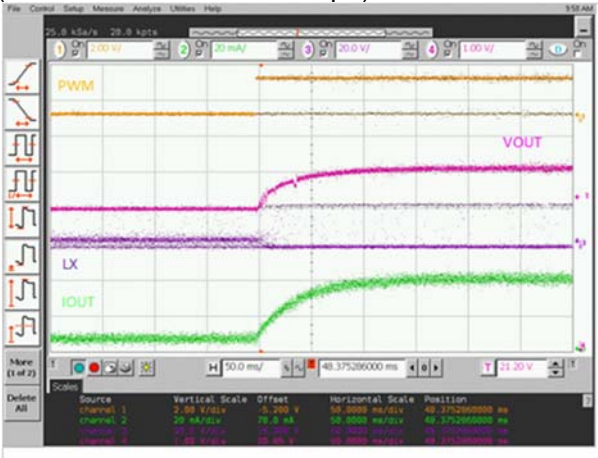

$V_{IN} = 3.6\text{ V} / 8\text{s}2\text{p LEDs}$

R1214Z221A ( $f_{PWM} = 20\text{ kHz}$ ,  $PWM\text{duty} = 90\% \rightarrow 10\%$ )  
 ( $R_{ISET} = 30.1\text{ k}\Omega / C_{ISET} = 2.0\text{ }\mu\text{F}$ )

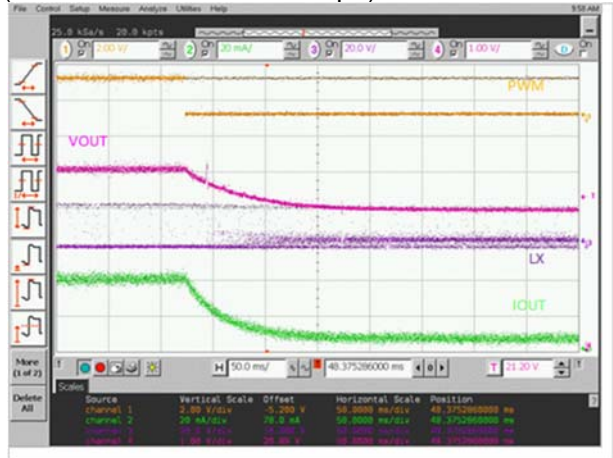

6) Electrical Characteristics

6-1) UVLO Voltage vs. Ambient Temperature

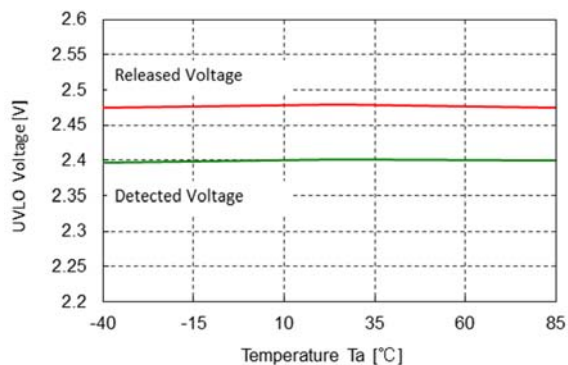

6-2) LED Regulated Voltage vs. Ambient Temperature

R1214ZxxxA/B

R1214ZxxxC/D

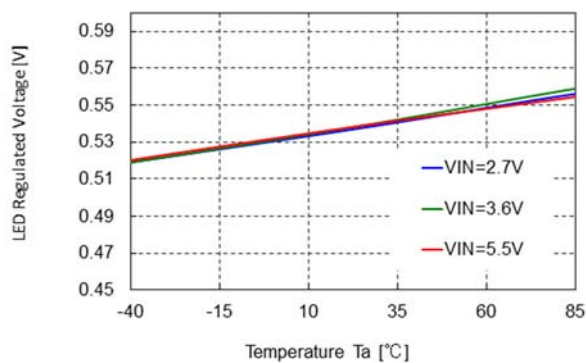
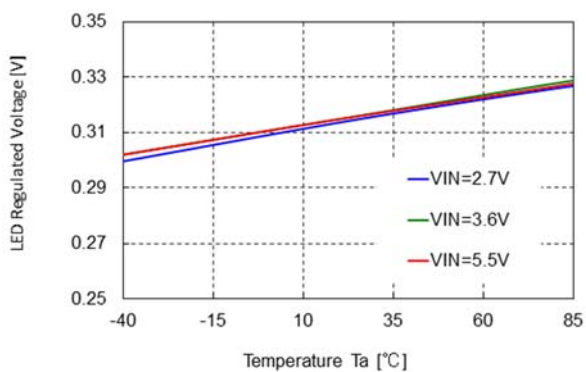

6-3) LED Current vs. Ambient Temperature

R1214ZxxxA/B

R1214ZxxxC/D

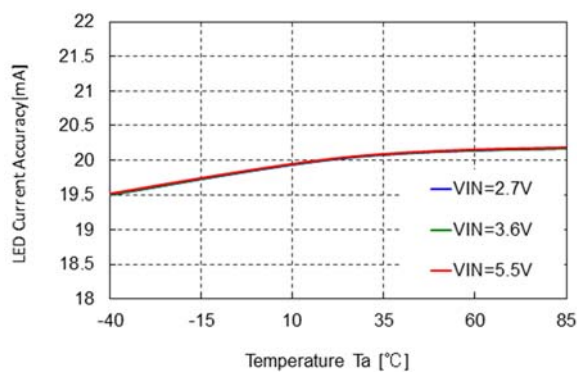
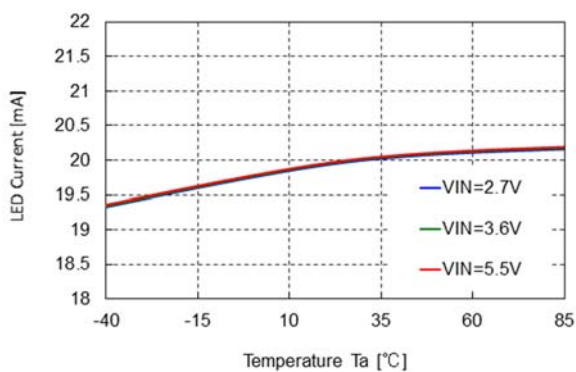

---

## R1214Z

---

NO.EA-327-170919

### 6-4) Nch ON Resistance vs. Ambient Temperature

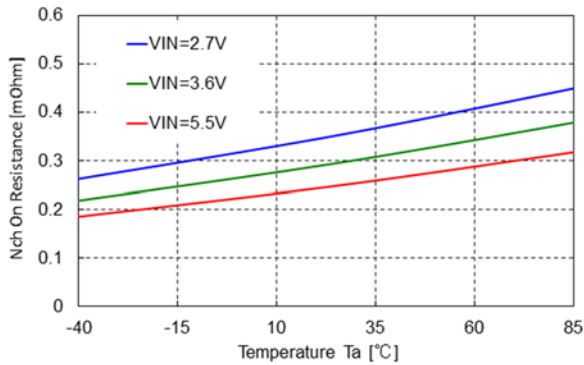

### 6-5) Oscillator Frequency vs. Ambient Temperature

R1214Z211x

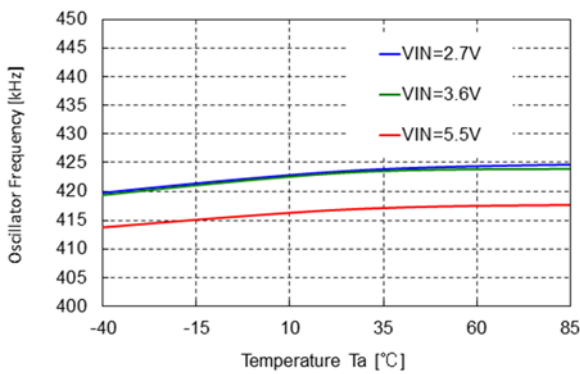

R1214Z221x

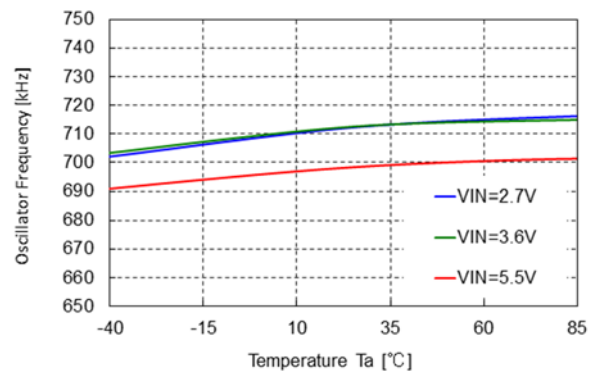

### 6-6) Maxduty vs. Ambient Temperature

R1214Z211x

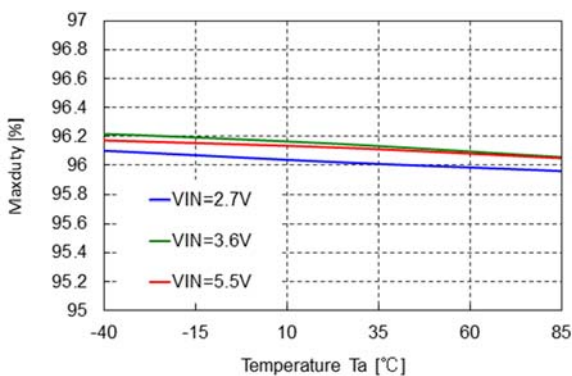

R1214Z221x

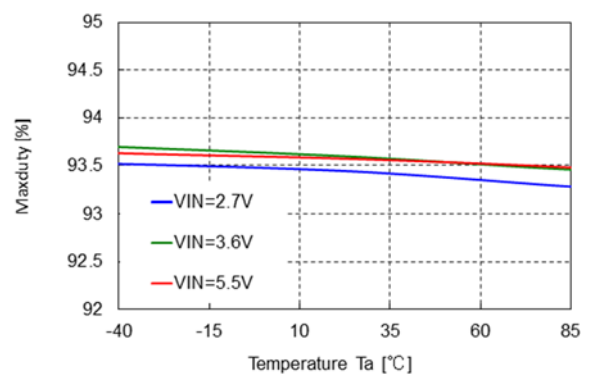

6-7) LxOVP Detect Voltage  
vs. Ambient Temperature

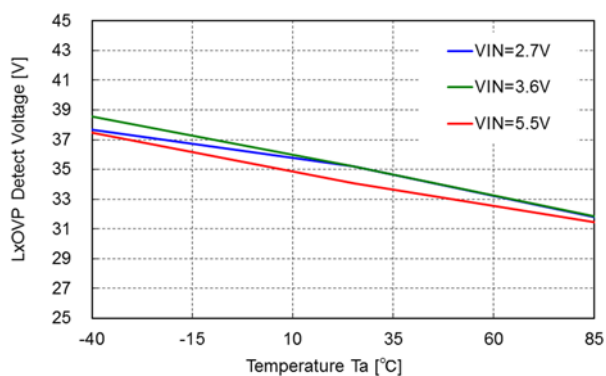

6-8) LEDOVP Detect Voltage  
vs. Ambient Temperature

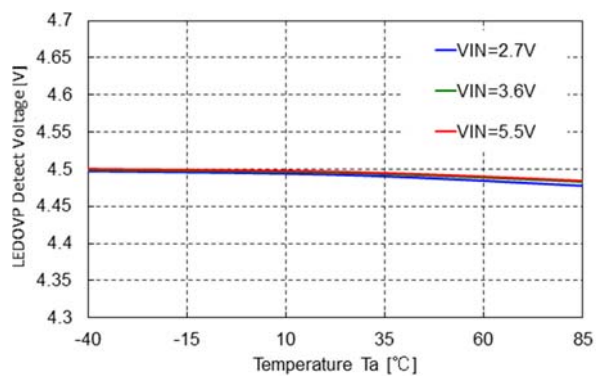

6-9) Soft start Time vs. Ambient Temperature

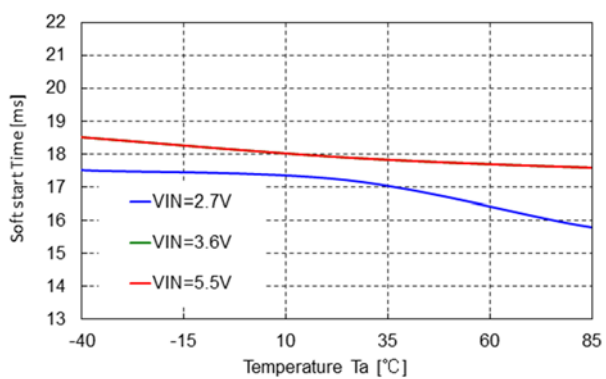

6-10) Lx Limit Current vs. Ambient Temperature

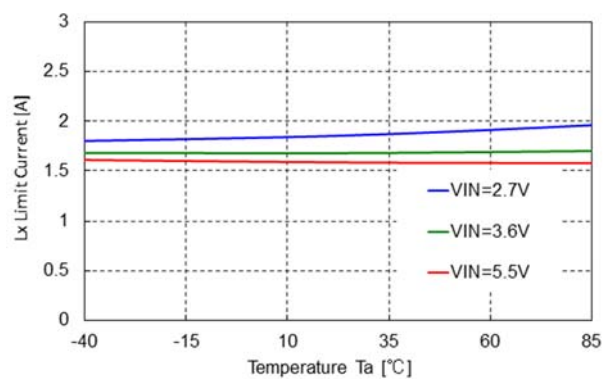

The power dissipation of the package is dependent on PCB material, layout, and environmental conditions. The following conditions are used in this measurement.

**Measurement Conditions**

<b>High Wattage Land Pattern</b>	
Environment	Mounting on Board (Wind Velocity = 0 m/s)
Board Material	Glass Cloth Epoxy Plastic (Four-layers)
Board Dimensions	76.2 mm × 114.3 mm × 1.6 mm
Copper Ratio	Outer Layers (First and Fourth Layers): Approx. 60% Inner Layers (Second and Third Layers): 100%

**Measurement Result**

(Ta = 25°C, Tjmax = 125°C)

<b>High Wattage Land Pattern</b>	
Power Dissipation	1190 mW
Thermal Resistance	$\theta_{ja} = (125 - 25^\circ\text{C}) / 1.19 \text{ W} = 84^\circ\text{C/W}$

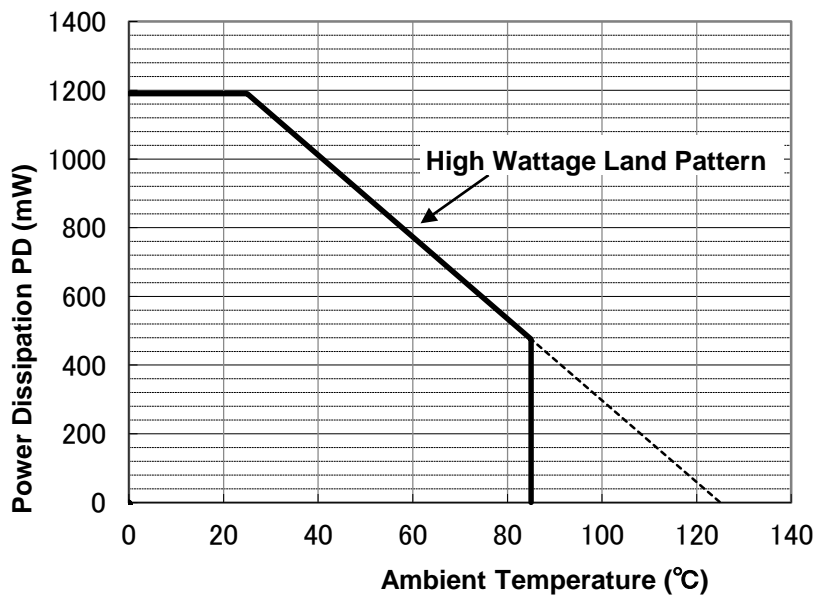

**Power Dissipation vs. Ambient Temperature**

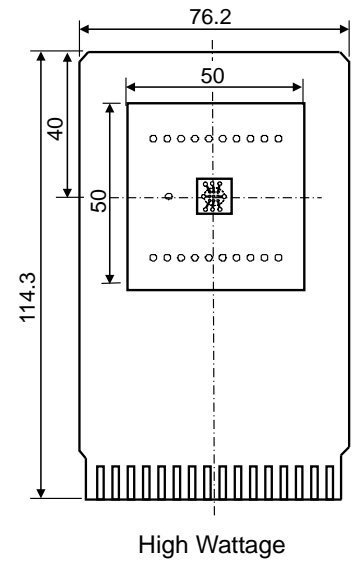

○ IC Mount Area (mm)  
**Measurement Board Pattern**



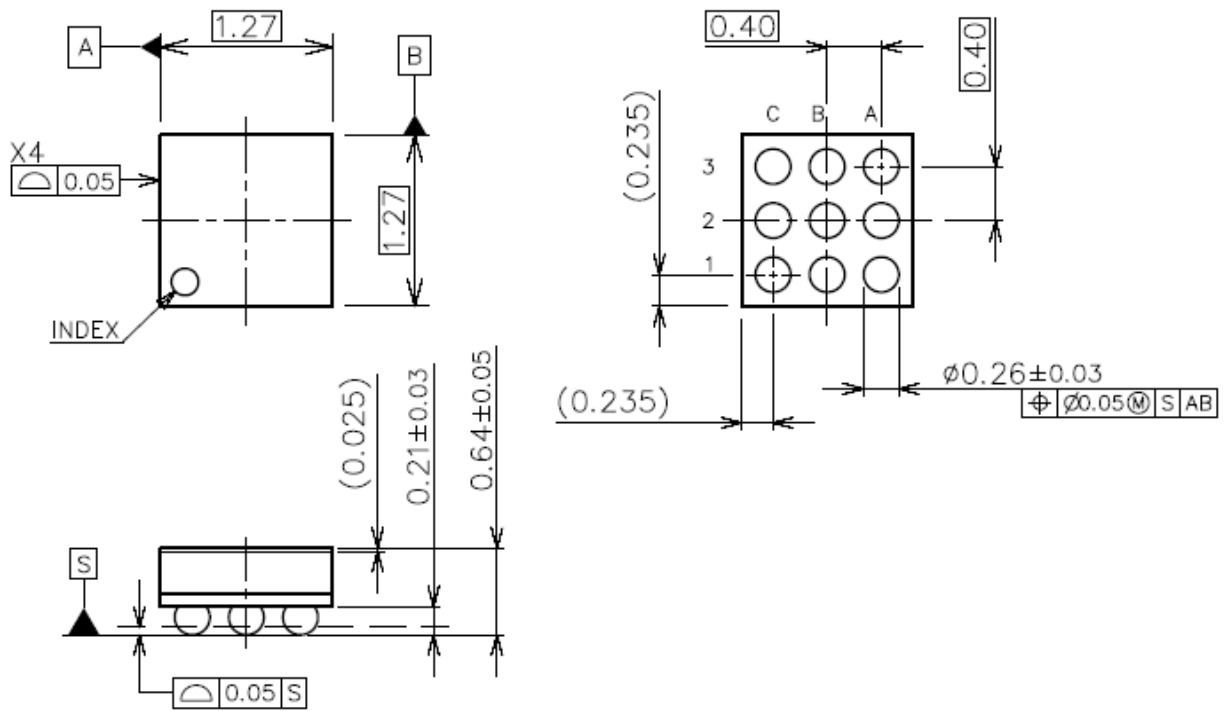

WLCSP-9-P1 Package Dimensions (Unit: mm)

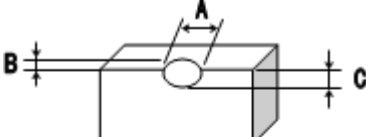
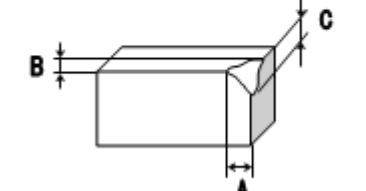
No.	Inspection Items	Inspection Criteria	Figure
1	Package chipping	<p><math>A \geq 0.2\text{mm}</math> is rejected  <math>B \geq 0.2\text{mm}</math> is rejected  <math>C \geq 0.2\text{mm}</math> is rejected                      And, Package chipping to Si surface and to bump is rejected.</p>	
2	Si surface chipping	<p><math>A \geq 0.2\text{mm}</math> is rejected  <math>B \geq 0.2\text{mm}</math> is rejected  <math>C \geq 0.2\text{mm}</math> is rejected                      But, even if <math>A \geq 0.2\text{mm}</math>, <math>B \leq 0.1\text{mm}</math> is acceptable.</p>	
3	No bump	No bump is rejected.	
4	Marking miss	To reject incorrect marking, such as another product name marking or another lot No. marking.	
5	No marking	To reject no marking on the package.	
6	Reverse direction of marking	To reject reverse direction of marking character.	
7	Defective marking	To reject unreadable marking. (Microscope: X15/ White LED/ Viewed from vertical direction)	
8	Scratch	To reject unreadable marking character by scratch. (Microscope: X15/ White LED/ Viewed from vertical direction)	
9	Stain and Foreign material	To reject unreadable marking character by stain and foreign material. (Microscope: X15/ White LED/ Viewed from vertical direction)	



1. The products and the product specifications described in this document are subject to change or discontinuation of production without notice for reasons such as improvement. Therefore, before deciding to use the products, please refer to Ricoh sales representatives for the latest information thereon.
2. The materials in this document may not be copied or otherwise reproduced in whole or in part without prior written consent of Ricoh.
3. Please be sure to take any necessary formalities under relevant laws or regulations before exporting or otherwise taking out of your country the products or the technical information described herein.
4. The technical information described in this document shows typical characteristics of and example application circuits for the products. The release of such information is not to be construed as a warranty of or a grant of license under Ricoh's or any third party's intellectual property rights or any other rights.
5. The products listed in this document are intended and designed for use as general electronic components in standard applications (office equipment, telecommunication equipment, measuring instruments, consumer electronic products, amusement equipment etc.). Those customers intending to use a product in an application requiring extreme quality and reliability, for example, in a highly specific application where the failure or misoperation of the product could result in human injury or death (aircraft, spacevehicle, nuclear reactor control system, traffic control system, automotive and transportation equipment, combustion equipment, safety devices, life support system etc.) should first contact us.
6. We are making our continuous effort to improve the quality and reliability of our products, but semiconductor products are likely to fail with certain probability. In order to prevent any injury to persons or damages to property resulting from such failure, customers should be careful enough to incorporate safety measures in their design, such as redundancy feature, fire containment feature and fail-safe feature. We do not assume any liability or responsibility for any loss or damage arising from misuse or inappropriate use of the products.
7. Anti-radiation design is not implemented in the products described in this document.
8. The X-ray exposure can influence functions and characteristics of the products. Confirm the product functions and characteristics in the evaluation stage.
9. WLCSP products should be used in light shielded environments. The light exposure can influence functions and characteristics of the products under operation or storage.
10. There can be variation in the marking when different AOI (Automated Optical Inspection) equipment is used. In the case of recognizing the marking characteristic with AOI, please contact Ricoh sales or our distributor before attempting to use AOI.
11. Please contact Ricoh sales representatives should you have any questions or comments concerning the products or the technical information.



**Ricoh is committed to reducing the environmental loading materials in electrical devices with a view to contributing to the protection of human health and the environment.**

Ricoh has been providing RoHS compliant products since April 1, 2006 and Halogen-free products since April 1, 2012.

**RICOH** RICOH ELECTRONIC DEVICES CO., LTD.

<https://www.e-devices.ricoh.co.jp/en/>

#### Sales & Support Offices

##### **Ricoh Electronic Devices Co., Ltd.**

##### **Shin-Yokohama Office (International Sales)**

2-3, Shin-Yokohama 3-chome, Kohoku-ku, Yokohama-shi, Kanagawa, 222-8530, Japan  
Phone: +81-50-3814-7687 Fax: +81-45-474-0074

##### **Ricoh Americas Holdings, Inc.**

675 Campbell Technology Parkway, Suite 200 Campbell, CA 95008, U.S.A.  
Phone: +1-408-610-3105

##### **Ricoh Europe (Netherlands) B.V.**

##### **Semiconductor Support Centre**

Prof. W.H. Keesomlaan 1, 1183 DJ Amstelveen, The Netherlands  
Phone: +31-20-5474-309

##### **Ricoh International B.V. - German Branch**

##### **Semiconductor Sales and Support Centre**

Oberrather Strasse 6, 40472 Düsseldorf, Germany  
Phone: +49-211-6546-0

##### **Ricoh Electronic Devices Korea Co., Ltd.**

3F, Haesung Bldg, 504, Teheran-ro, Gangnam-gu, Seoul, 135-725, Korea  
Phone: +82-2-2135-5700 Fax: +82-2-2051-5713

##### **Ricoh Electronic Devices Shanghai Co., Ltd.**

Room 403, No.2 Building, No.690 Bibo Road, Pu Dong New District, Shanghai 201203,  
People's Republic of China  
Phone: +86-21-5027-3200 Fax: +86-21-5027-3299

##### **Ricoh Electronic Devices Shanghai Co., Ltd.**

##### **Shenzhen Branch**

1205, Block D (Jinlong Building), Kingkey 100, Hongbao Road, Luohu District,  
Shenzhen, China  
Phone: +86-755-8348-7600 Ext 225

##### **Ricoh Electronic Devices Co., Ltd.**

##### **Taipei office**

Room 109, 10F-1, No.51, Hengyang Rd., Taipei City, Taiwan (R.O.C.)  
Phone: +886-2-2313-1621/1622 Fax: +886-2-2313-1623