PWM Step-up DC/DC Controller

NO.EA-064-181214

OUTLINE

The R1210Nxx2C/xx2D Series are CMOS-based PWM step-up DC/DC Converter controllers, with high accuracy, low supply current.

Each of the R1210Nxx2x Series consists of an oscillator, a PWM circuit, a reference voltage unit, an error amplifier, phase compensation circuit, resistors for voltage detection, a chip enable circuit, a controller against drastic load transient and an output voltage detector. A low ripple, high efficiency step-up DC/DC converter can be composed of this IC with only four external components, or an inductor, a diode, a transistor and a capacitor.

The R1210Nxx2x Series can detect drastic change of output voltage with a circuit controller, the load transient response is improved.

Each of the R1210Nxx2x Series has a driver pin, or 'EXT' pin for external transistor. By connecting a power transistor with low ON-resistance to EXT pin, a large current flows through an inductor, thus, large output current can be supplied.

The built-in chip enable circuit can make the standby mode with ultra low quiescent current.

Since the package for these ICs is small SOT-23-5, high density mounting of the ICs on board is possible.

FEATURES

- External Components Only an inductor, a diode, a capacitor, and a transistor
- Standby Current Max. 0.5 μ A
- Low Temperature-Drift Coefficient of Output Voltage Typ. \pm 100ppm/ $^{\circ}$ C
- Output Voltage Stepwise Setting with a step of 0.1V in the range of 2.2V to 6.0V
- Two choices of Basic Oscillator Frequency 100kHz (xx2C), 180kHz (xx2D)
- Output Voltage Accuracy \pm 2.5%
- Small Package SOT-23-5
- Low Ripple, Low Noise
- Oscillator Start-up Voltage Max. 0.8V

APPLICATIONS

- Power source for battery-powered equipment.
- Power source for portable communication appliances, cameras, VCRs
- Power source for appliances of which require higher voltage than battery voltage.

BLOCK DIAGRAMS

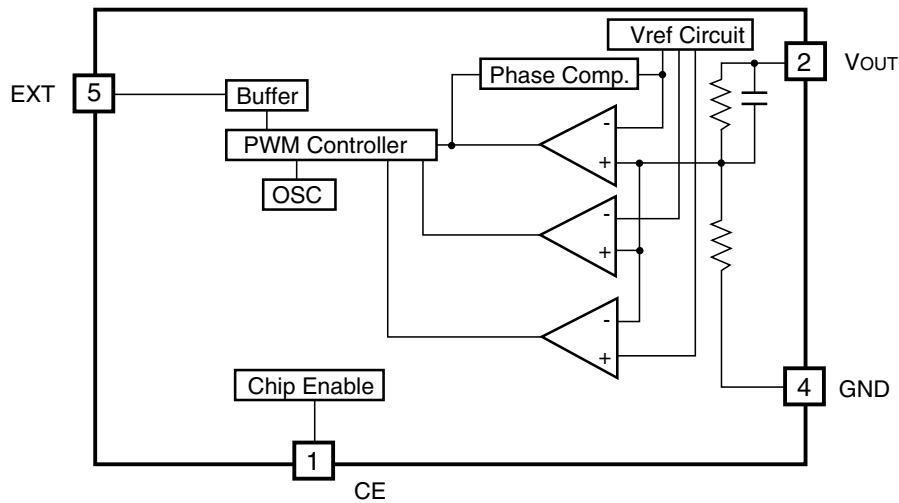

SELECTION GUIDE

In the R1210N Series, the output voltage, the oscillator frequency for the ICs can be selected at the user's request.

The selection can be made by designating the part number as shown below;

| Product Name | Package | Quantity per Reel | Pb Free | Halogen Free |
|---|----------|-------------------|---------|--------------|
| R1210Nxx2*-TR-FE | SOT-23-5 | 3,000 pcs | Yes | Yes |
| xx : Setting Output Voltage(V_{OUT}) Stepwise setting with a step of 0.1V in the range of 2.2V (22) to 6.0V (60) | | | | |
| * : Designation of Oscillator Frequency C : 100kHz D : 180kHz | | | | |

PIN CONFIGURATION

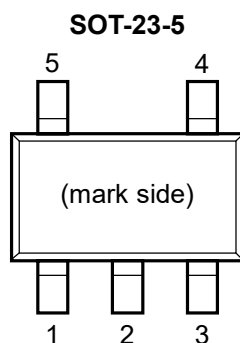

PIN DESCRIPTIONS

| Pin No | Symbol | Pin Description |
|--------|------------------|-------------------------------|
| 1 | CE | Chip Enable Pin |
| 2 | V _{OUT} | Pin for Output Voltage |
| 3 | NC | No Connection |
| 4 | GND | Ground Pin |
| 5 | EXT | External Transistor Drive Pin |

ABSOLUTE MAXIMUM RATINGS

| Symbol | Item | Rating | Unit |
|------------------|-------------------------------------|-------------------------------|------|
| V _{OUT} | V _{OUT} Pin Output Voltage | -0.3 to 9.0 | V |
| V _{EXT} | EXT Pin Output Voltage | -0.3 to V _{OUT} +0.3 | V |
| V _{CE} | CE Pin Input Voltage | -0.3 to 9.0 | V |
| I _{EXT} | EXT Pin Output Current | ±40 | mA |
| P _D | Power Dissipation | 420 | mW |
| T _{opt} | Operating Temperature Range | -40 to +85 | °C |
| T _{stg} | Storage Temperature Range | -55 to +125 | °C |

*1) For Power Dissipation, please refer to PACKAGE INFORMATION.

ABSOLUTE MAXIMUM RATINGS

Electronic and mechanical stress momentarily exceeded absolute maximum ratings may cause the permanent damages and may degrade the life time and safety for both device and system using the device in the field.

The functional operation at or over these absolute maximum ratings is not assured.

ELECTRICAL CHARACTERISTICS

• R1210Nxx2x

T_{opt}=25°C

| Symbol | Item | Conditions | Min. | Typ. | Max. | Unit |
|-----------------------|--|--|--------|------|--------|--------------|
| V _{OUT} | Output Voltage | V _{IN} =V _{SET} ×0.6, I _{OUT} =1mA | ×0.975 | | ×1.025 | V |
| V _{IN} | Maximum Input Voltage | | | | 8 | V |
| ΔV _{OUT} /ΔT | Step-up Output Voltage Temperature Coefficient | -40°C ≤ T _{opt} ≤ 85°C | | ±100 | | ppm/°C |
| V _{start} | Start-up Voltage | V _{IN} =0V→2V | | | 0.8 | V |
| I _{standby} | Supply Current 3(Standby) | V _{OUT} =6.5V, V _{CE} =0V | | | 0.5 | μA |
| I _{DD1} | Supply Current 1 | V _{OUT} = V _{SET} ×0.96 EXT at no load 2.2V ≤ V _{SET} ≤ 2.4V | | 18 | 35 | μA (xx2C) |
| | | | | 23 | 45 | μA (xx2D) |
| | | V _{OUT} = V _{SET} ×0.96 EXT at no load 2.5V ≤ V _{SET} ≤ 3.0V | | 20 | 40 | μA (xx2C) |
| | | | | 25 | 50 | μA (xx2D) |
| | | V _{OUT} = V _{SET} ×0.96 EXT at no load 3.1V ≤ V _{SET} ≤ 3.9V | | 25 | 50 | μA (xx2C) |
| | | | | 30 | 60 | μA (xx2D) |
| | | V _{OUT} = V _{SET} ×0.96 EXT at no load 4.0V ≤ V _{SET} ≤ 4.4V | | 30 | 60 | μA (xx2C) |
| | | | | 35 | 70 | μA (xx2D) |
| | | V _{OUT} = V _{SET} ×0.96 EXT at no load 4.5V ≤ V _{SET} ≤ 4.9V | | 35 | 70 | μA (xx2C) |
| | | | | 40 | 80 | μA (xx2D) |
| | | V _{OUT} = V _{SET} ×0.96 EXT at no load 5.0V ≤ V _{SET} ≤ 5.4V | | 45 | 90 | μA (xx2C) |
| | | | | 50 | 100 | μA (xx2D) |
| | | V _{OUT} = V _{SET} ×0.96 EXT at no load 5.5V ≤ V _{SET} ≤ 6.0V | | 50 | 100 | μA (xx2C) |
| | | | | 55 | 110 | μA (xx2D) |
| I _{DD2} | Supply Current 2 | V _{OUT} =V _{CE} =V _{SET} +0.5 | | 10 | 15 | μA (xx2C) |
| | | | | 15 | 22 | μA (xx2D) |

| Symbol | Item | Conditions | Min. | Typ. | Max. | Unit |
|--------------------------|--|---|------|------|------|-------------------------|
| I _{EXTH} | EXT "H" Output Current | $2.2V \leq V_{SET} \leq 2.5V$ $V_{EXT}=V_{OUT}-0.4V$ | | | -1.0 | mA |
| | | $2.6V \leq V_{SET} \leq 3.0V$ $V_{EXT}=V_{OUT}-0.4V$ | | | -2.0 | mA |
| | | $3.1V \leq V_{SET} \leq 3.5V$ $V_{EXT}=V_{OUT}-0.4V$ | | | -2.5 | mA |
| | | $3.6V \leq V_{SET} \leq 4.0V$ $V_{EXT}=V_{OUT}-0.4V$ | | | -3.0 | mA |
| | | $4.1V \leq V_{SET} \leq 4.5V$ $V_{EXT}=V_{OUT}-0.4V$ | | | -3.5 | mA |
| | | $4.6V \leq V_{SET} \leq 5.0V$ $V_{EXT}=V_{OUT}-0.4V$ | | | -4.0 | mA |
| | | $5.1V \leq V_{SET} \leq 5.5V$ $V_{EXT}=V_{OUT}-0.4V$ | | | -4.5 | mA |
| | | $5.6V \leq V_{SET} \leq 6.0V$ $V_{EXT}=V_{OUT}-0.4V$ | | | -5.0 | mA |
| fosc | Maximum Oscillator Frequency | $V_{OUT}=V_{CE}=V_{SET} \times 0.96$ | 80 | 100 | 120 | kHz (xx2C) |
| | | | 144 | 180 | 216 | kHz (xx2D) |
| $\Delta fosc / \Delta T$ | Oscillator Frequency Temperature Coefficient | $-40^{\circ}C \leq T_{opt} \leq 85^{\circ}C$ | | 0.5 | | kHz/ $^{\circ}C$ (xx2C) |
| | | | | 0.6 | | kHz/ $^{\circ}C$ (xx2D) |
| Maxdty | Oscillator Maximum Duty Cycle | $V_{OUT}=V_{CE}=V_{SET} \times 0.96$, (V _{EXT} "H" Side) | 70 | 85 | 97 | % |
| I _{EXTL} | EXT "L" Output Current | $2.2V \leq V_{SET} \leq 2.5V, V_{EXT}=0.4V$ | 1.0 | | | mA |
| | | $2.6V \leq V_{SET} \leq 3.0V, V_{EXT}=0.4V$ | 2.0 | | | mA |
| | | $3.1V \leq V_{SET} \leq 3.5V, V_{EXT}=0.4V$ | 2.5 | | | mA |
| | | $3.6V \leq V_{SET} \leq 4.0V, V_{EXT}=0.4V$ | 3.0 | | | mA |
| | | $4.1V \leq V_{SET} \leq 4.5V, V_{EXT}=0.4V$ | 3.5 | | | mA |
| | | $4.6V \leq V_{SET} \leq 5.0V, V_{EXT}=0.4V$ | 4.0 | | | mA |
| | | $5.1V \leq V_{SET} \leq 5.5V, V_{EXT}=0.4V$ | 4.5 | | | mA |
| | | $5.6V \leq V_{SET} \leq 6.0V, V_{EXT}=0.4V$ | 5.0 | | | mA |
| V _{CEH} | CE "H" Input Voltage | $V_{OUT}=V_{SET} \times 0.96$ | 0.9 | | | V |
| V _{CEL} | CE "L" Input Voltage | $V_{OUT}=V_{SET} \times 0.96$ | | | 0.3 | V |
| I _{CEH} | CE "H" Input Current | $V_{OUT}=V_{CE}=6.5V$ | -0.1 | 0.0 | 0.1 | μA |
| I _{CEL} | CE "L" Input Current | $V_{IN}=6.5V, V_{CE}=0V$ | -0.1 | 0.0 | 0.1 | μA |

*Note: V_{SET} means setting Output Voltage.

RECOMMENDED OPERATING CONDITIONS (ELECTRICAL CHARACTERISTICS)

All of electronic equipment should be designed that the mounted semiconductor devices operate within the recommended operating conditions. The semiconductor devices cannot operate normally over the recommended operating conditions, even if when they are used over such conditions by momentary electronic noise or surge. And the semiconductor devices may receive serious damage when they continue to operate over the recommended operating conditions.

TEST CIRCUITS

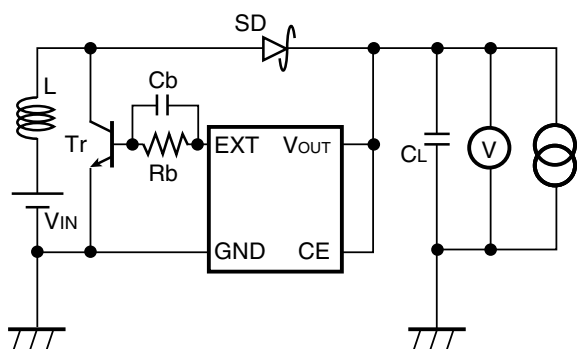

Test Circuit 1

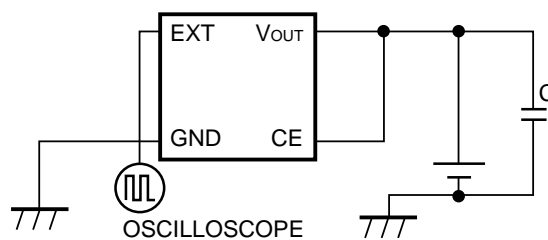

Test Circuit 2

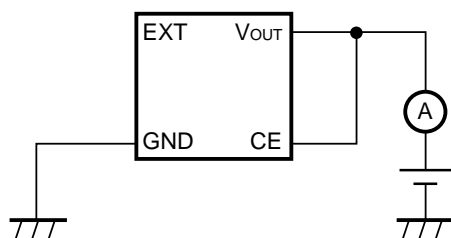

Test Circuit 3

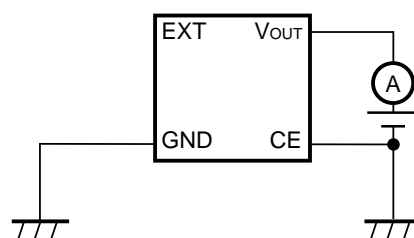

Test Circuit 4

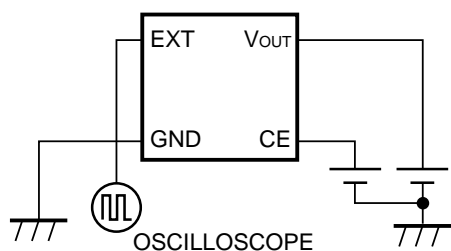

Test Circuit 5

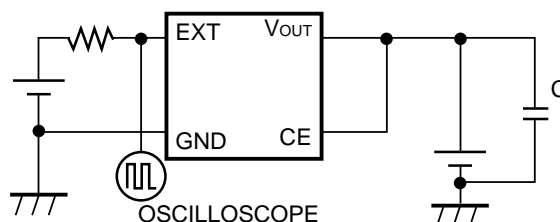

Test Circuit 6

| | |
|---------------------|--|
| Inductor (L) | : 27 μ H (Sumida Electric Co., Ltd. CD104NP) |
| Diode (SD) | : RB491D (Rohm, Schottky Type) |
| Capacitor (CL) | : 47 μ F \times 2 (Tantalum Type) |
| Transistor (Tr) | : 2SD1628G |
| Base Resistor (Rb) | : 300 Ω |
| Base Capacitor (Cb) | : 0.01 μ F (Ceramic Type) |

The typical characteristics were obtained by use of these test circuits.

- Test Circuit 1 : Typical Characteristics 1) 2) 3) 4) 5)
- Test Circuit 2 : Typical Characteristics 9) 10)
- Test Circuit 3 : Typical Characteristics 6) 7)
- Test Circuit 4 : Typical Characteristics 8)
- Test Circuit 5 : Typical Characteristics 11)
- Test Circuit 6 : Typical Characteristics 12)

TYPICAL CHARACTERISTICS

1) Output Voltage vs. Output Current

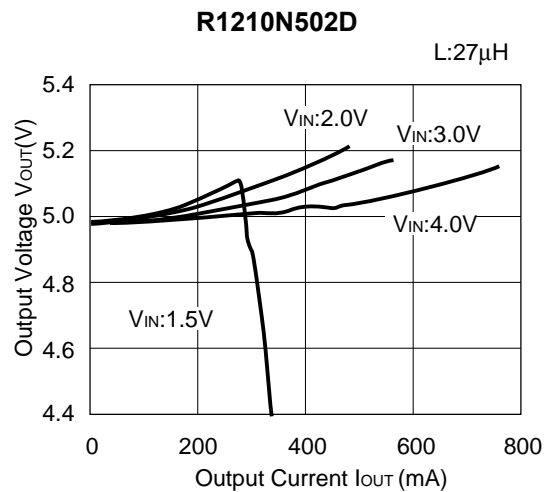
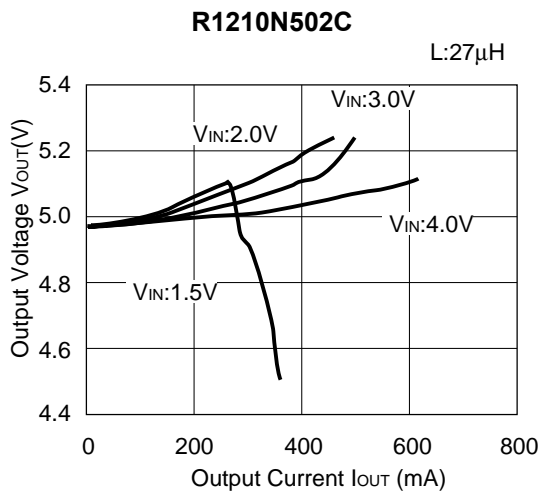
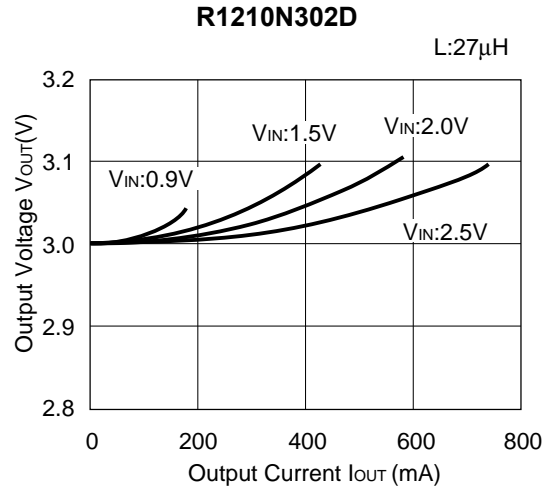
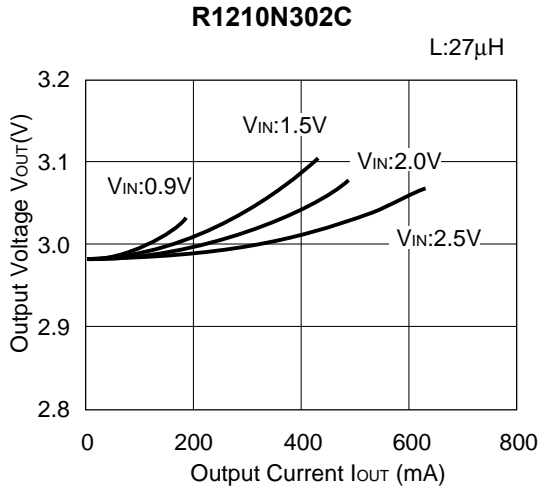

2) Efficiency vs. Output Current

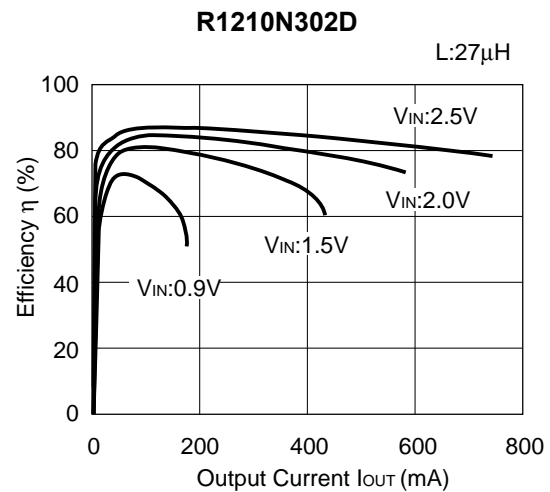
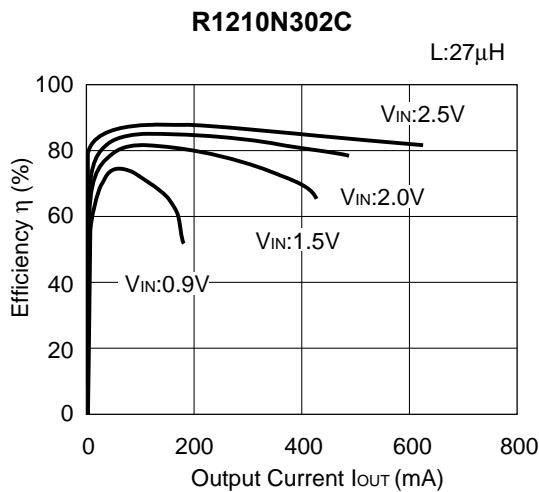

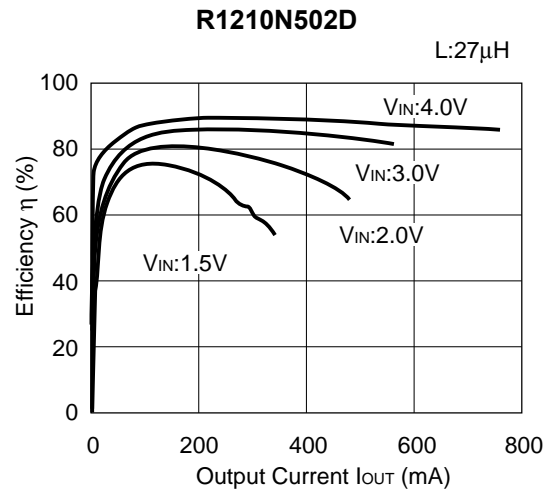
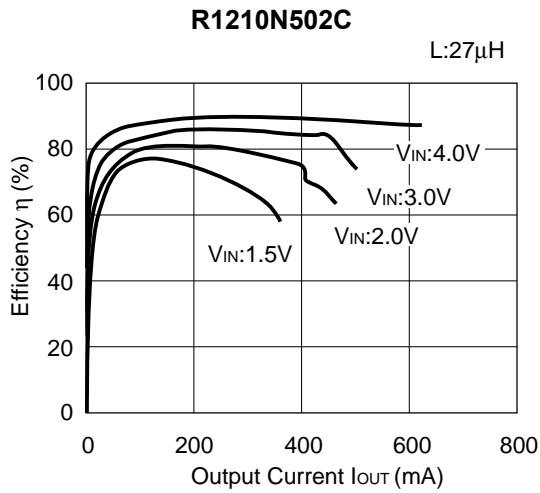

3) Ripple Voltage vs. Output Current

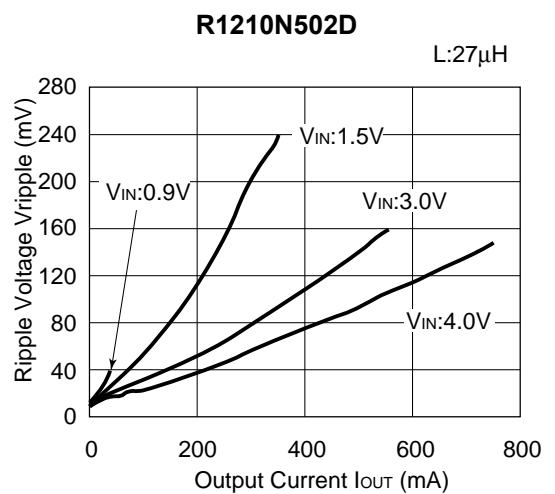
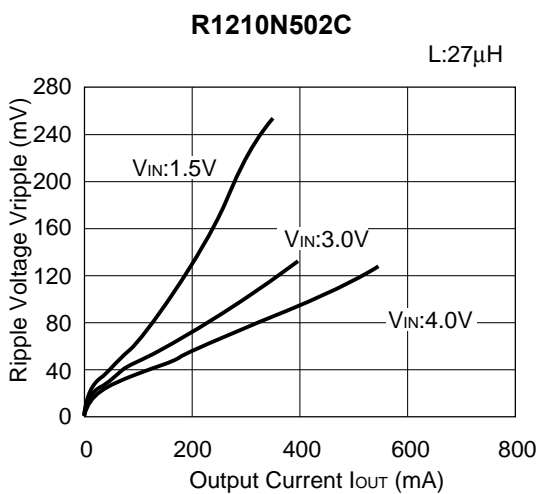
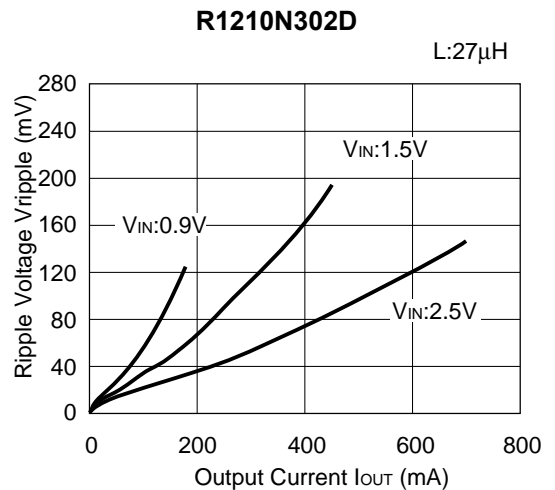
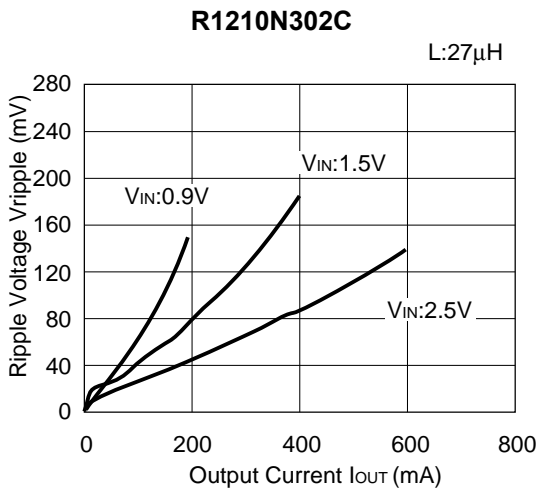

4) Start-up Voltage/ Hold-on Voltage vs. Output Current (Topt=25°C)

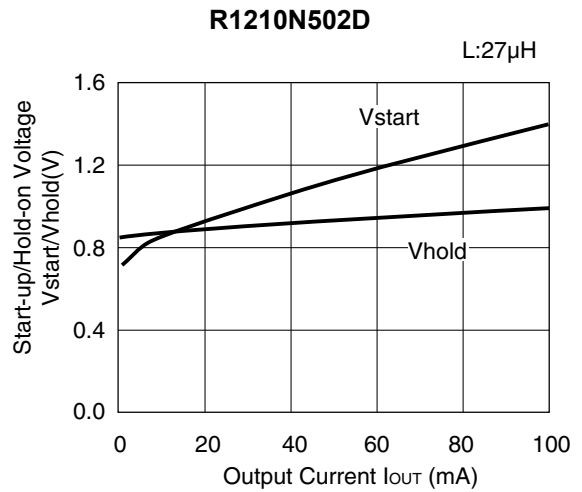
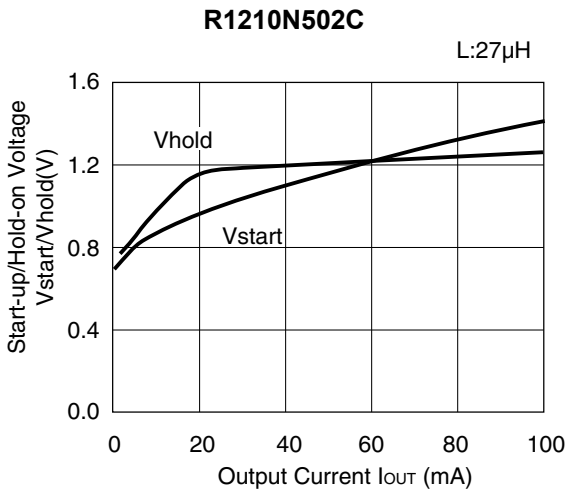
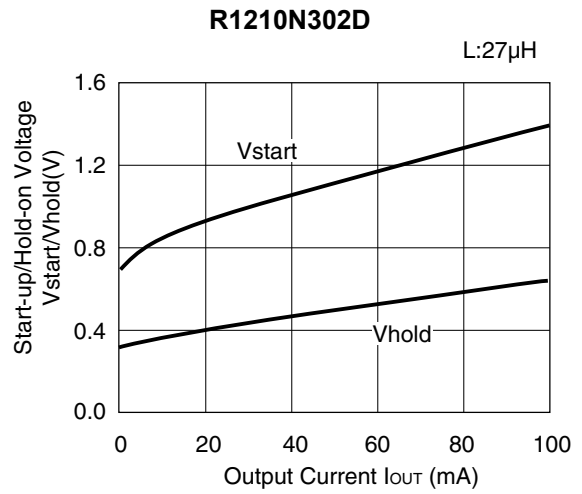
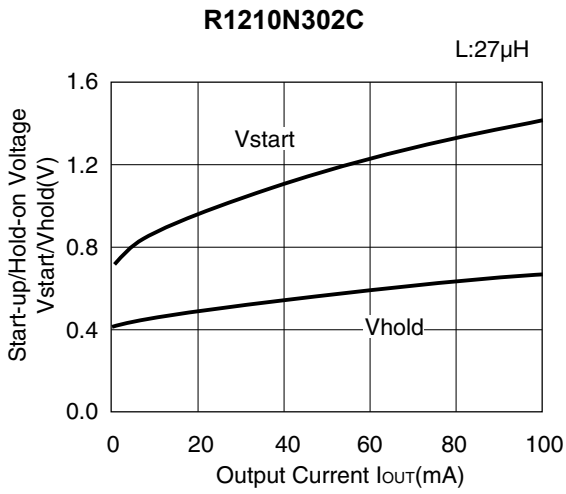

5) Output Voltage vs. Temperature

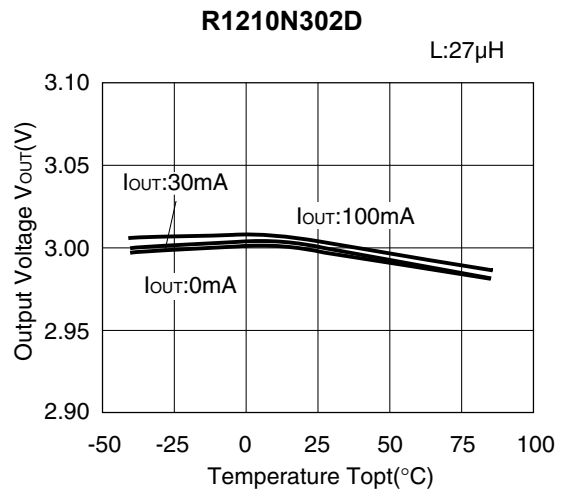
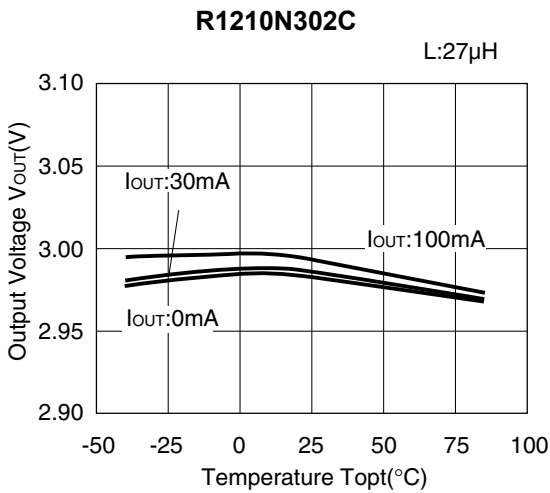

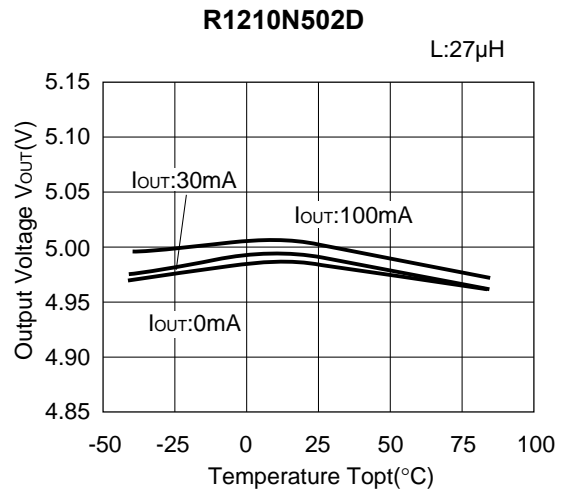
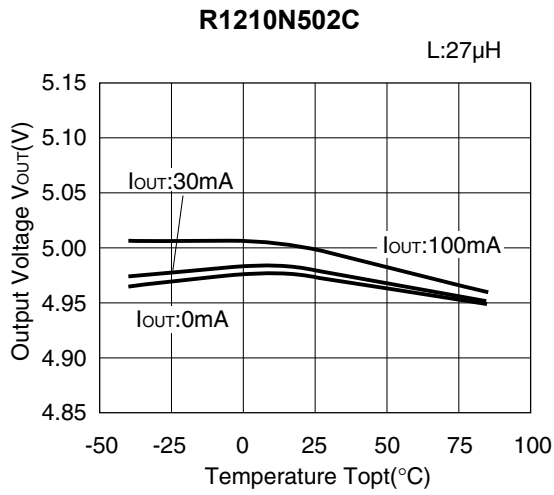

6) Supply Current 1 vs. Temperature

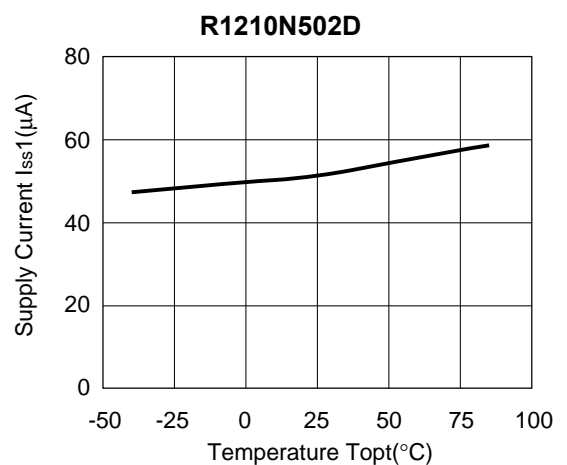
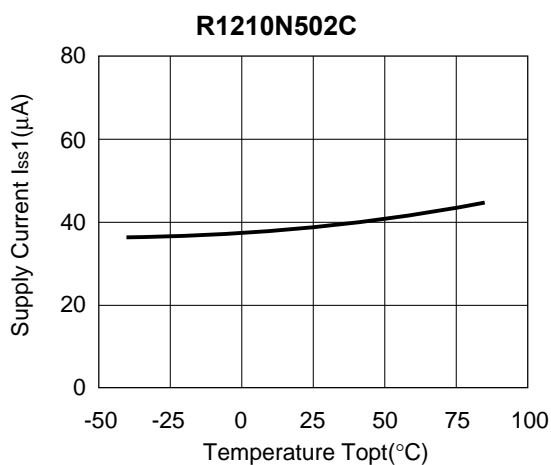
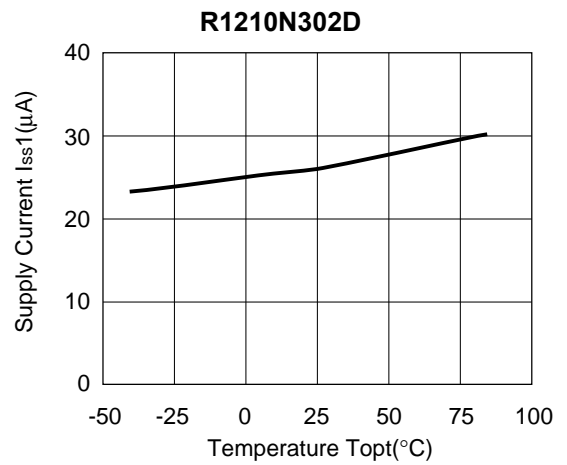
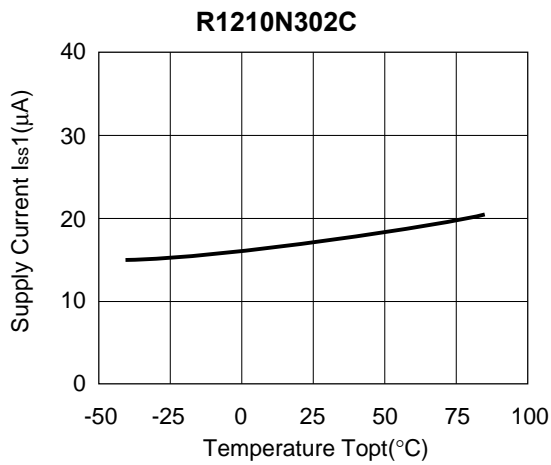

7) Supply Current 2 vs. Temperature

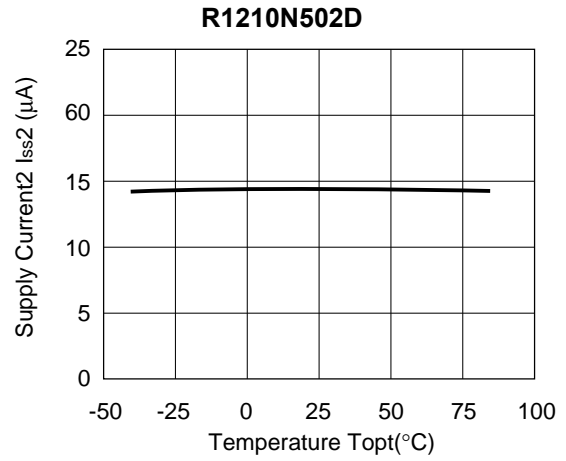
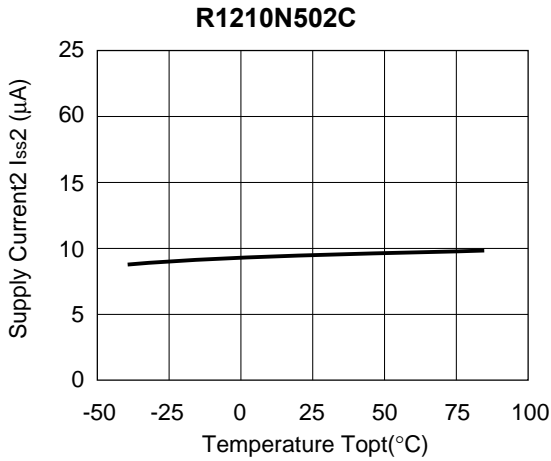
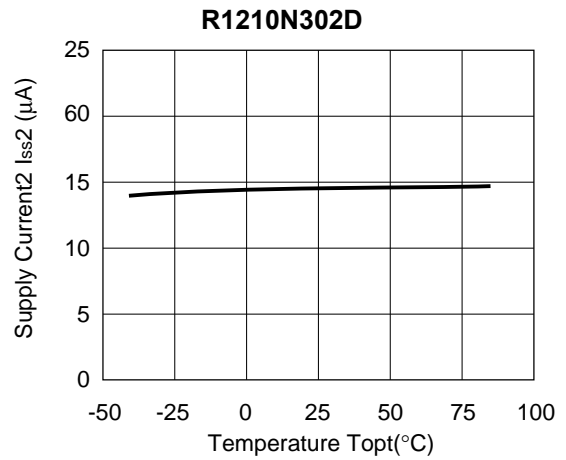
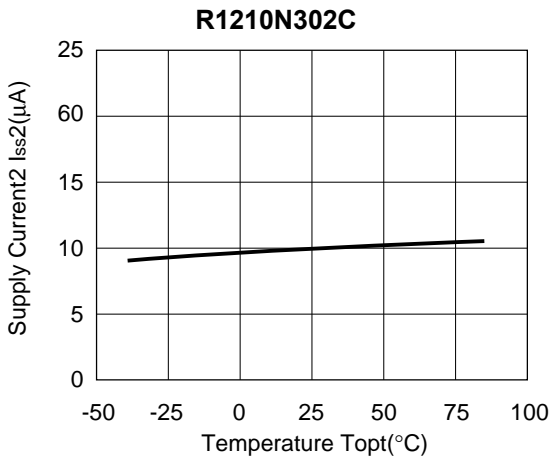

8) Supply Current 3 vs. Temperature

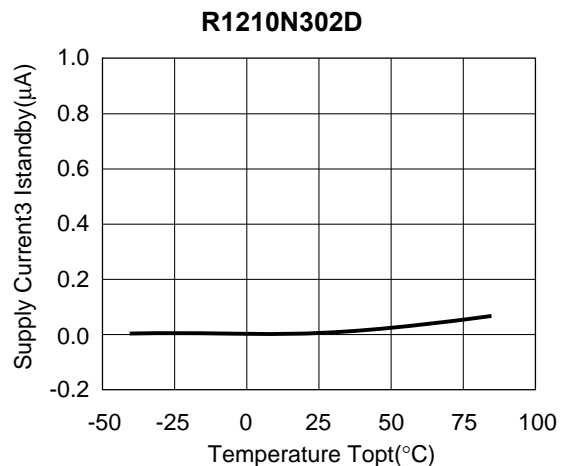
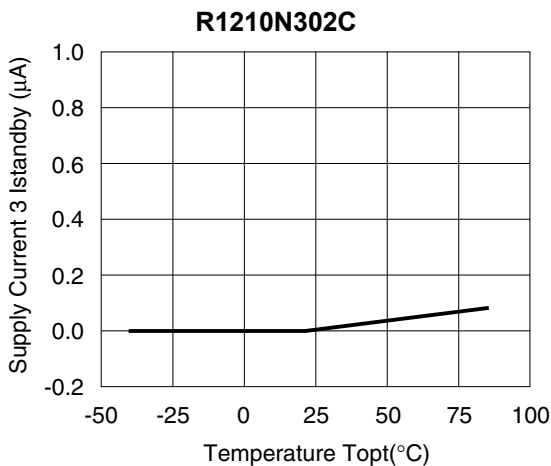

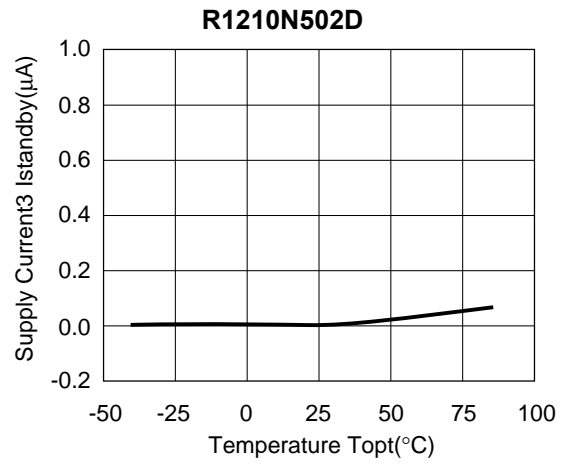
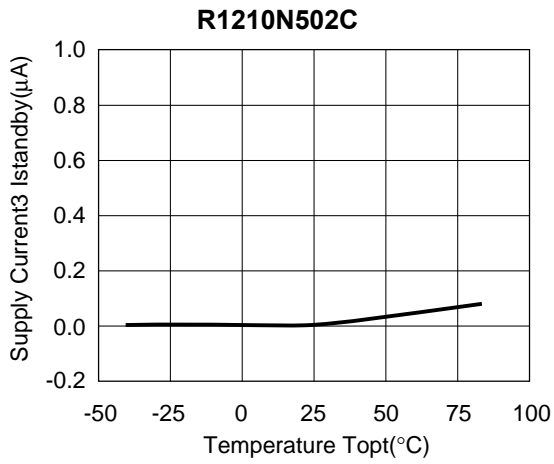

9) Oscillator Frequency vs. Temperature

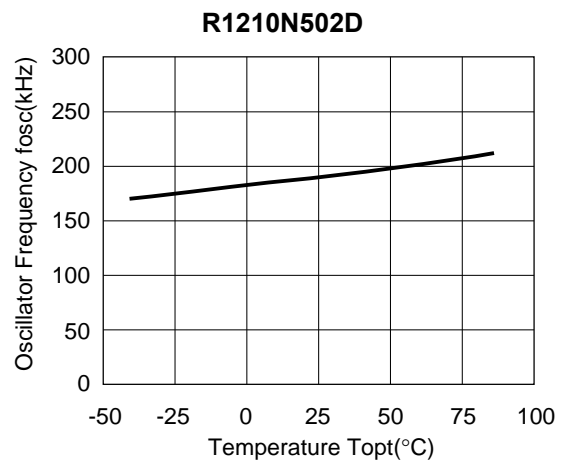
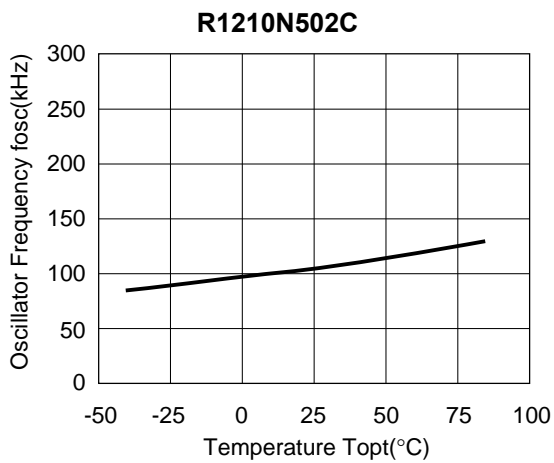
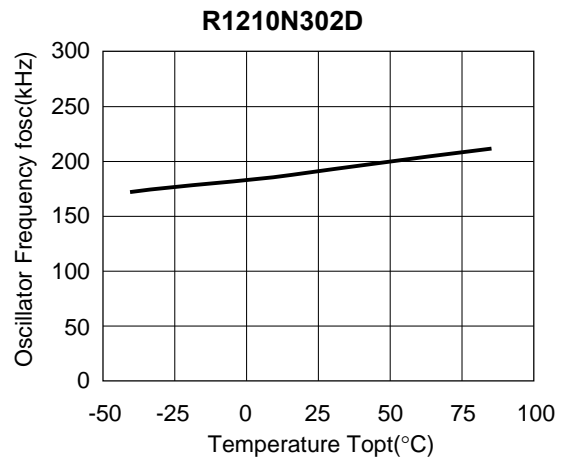
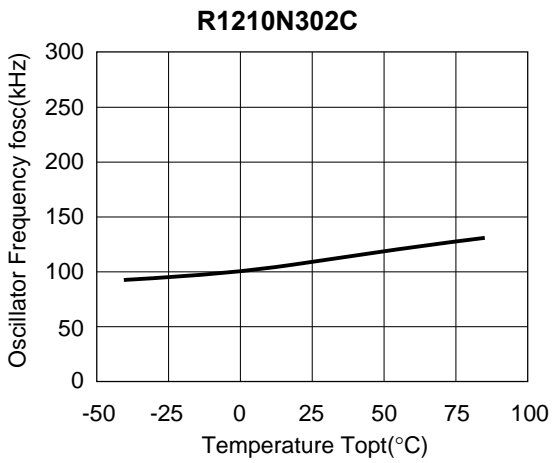

10) Maximum Duty Cycle vs. Temperature

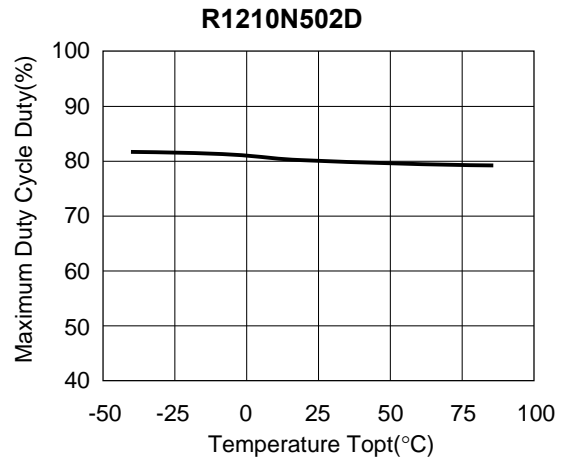
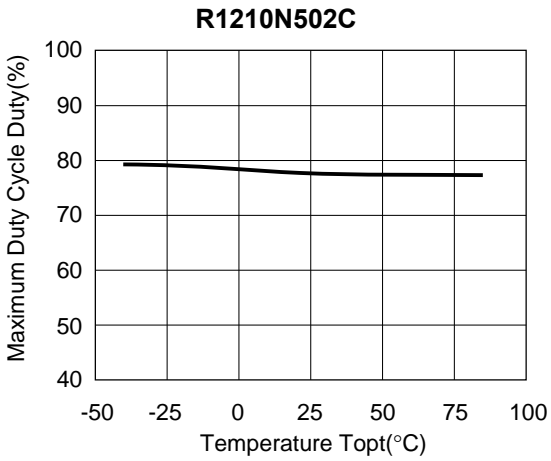
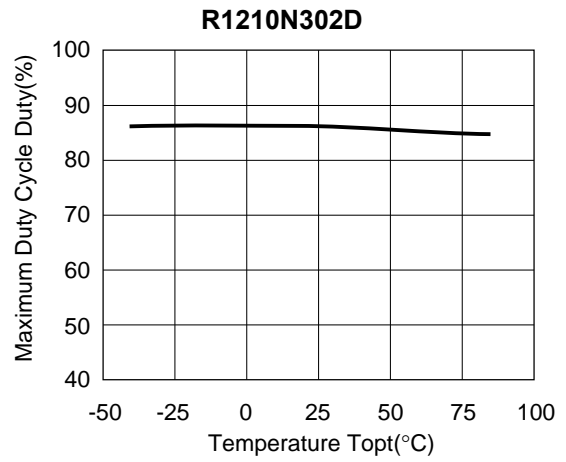
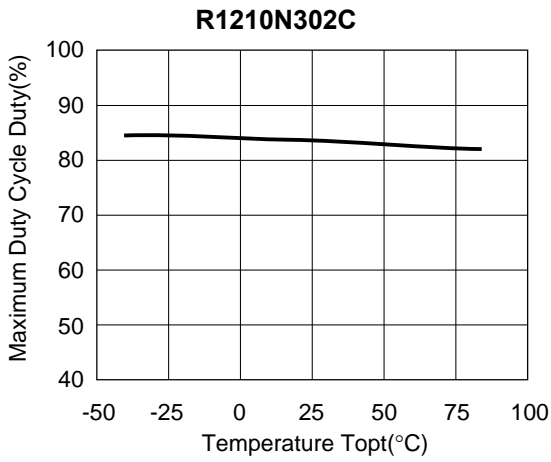

11) EXT "H" Output Current vs. Temperature

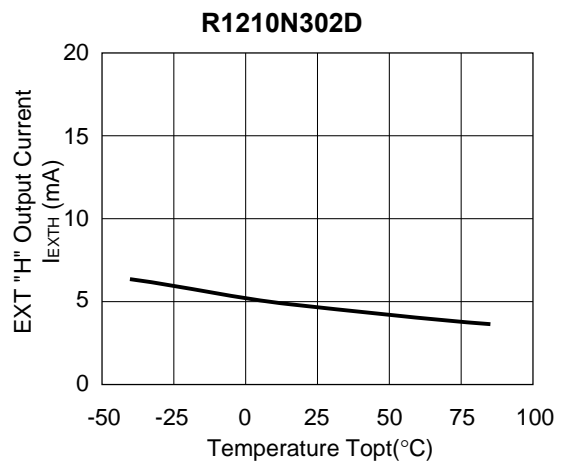
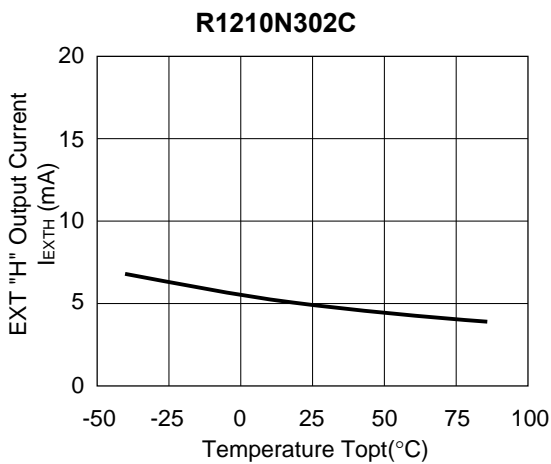

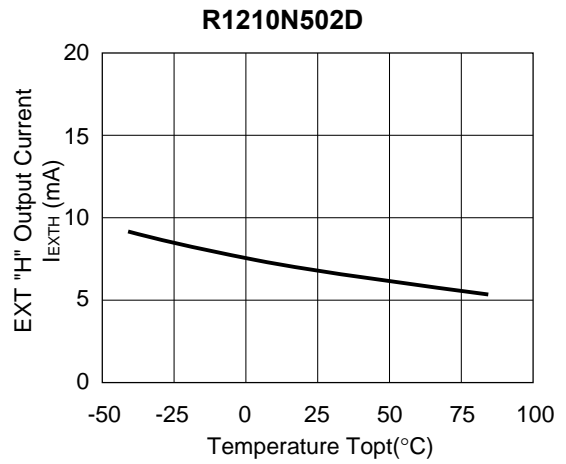
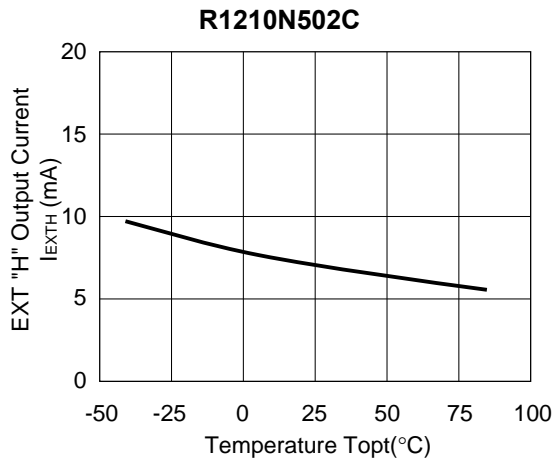

12) EXT "L" Output Current vs. Temperature

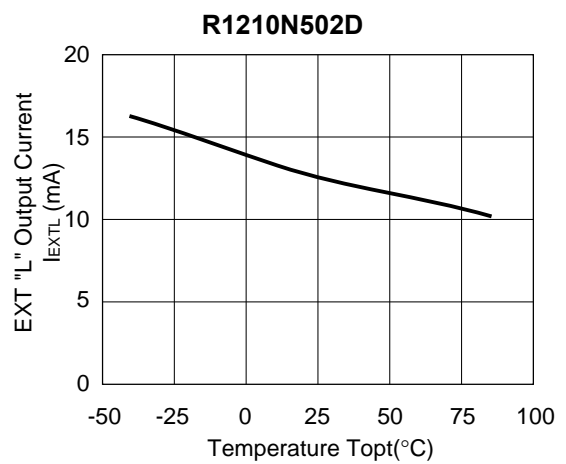
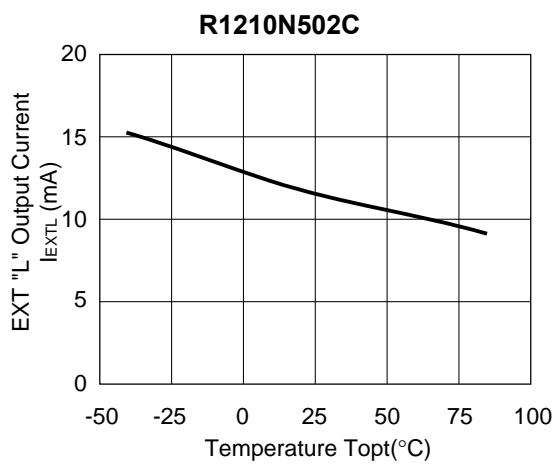
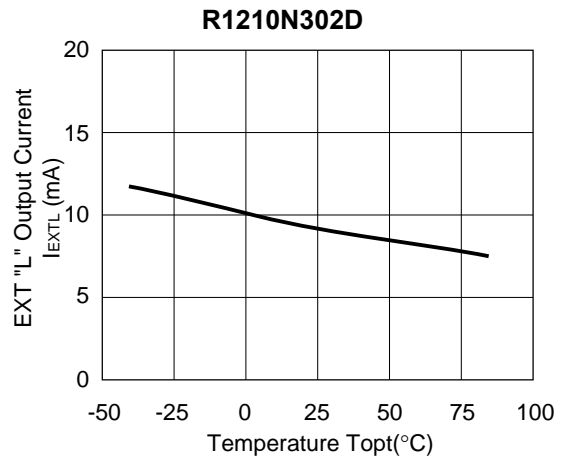
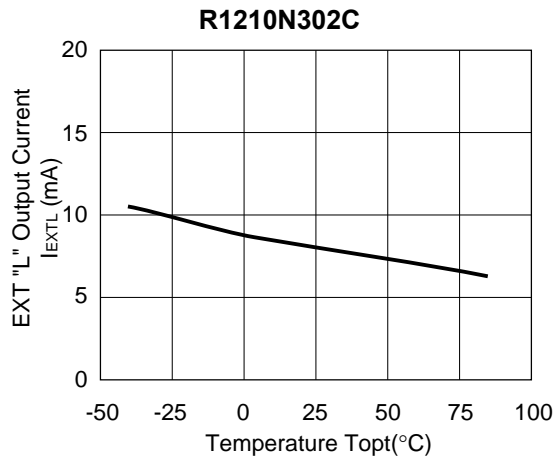

13) CE "H" Input Voltage vs. Temperature

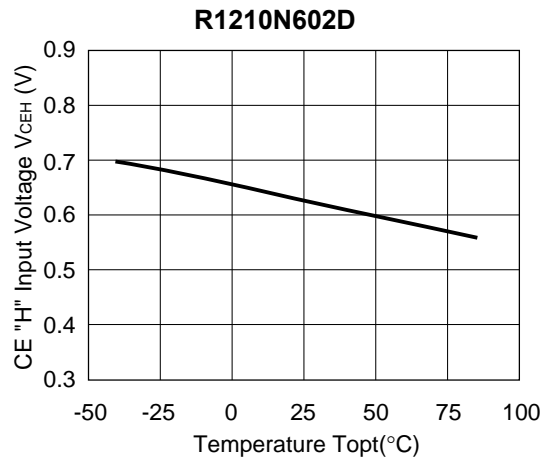
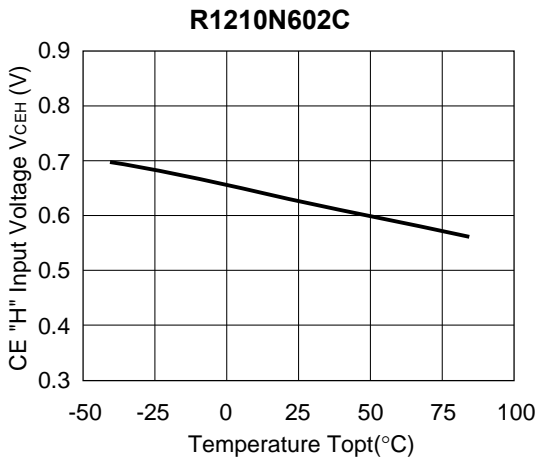

14) CE "L" Input Voltage vs. Temperature

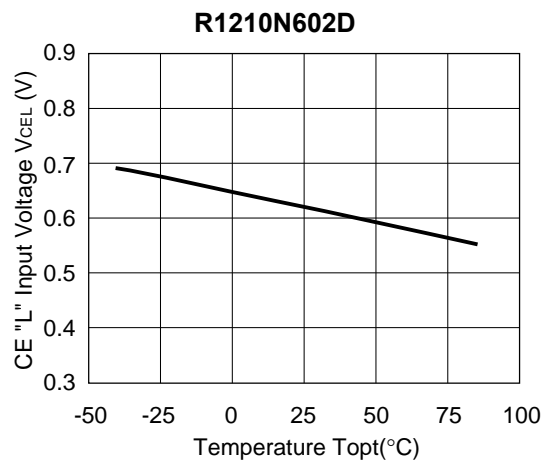
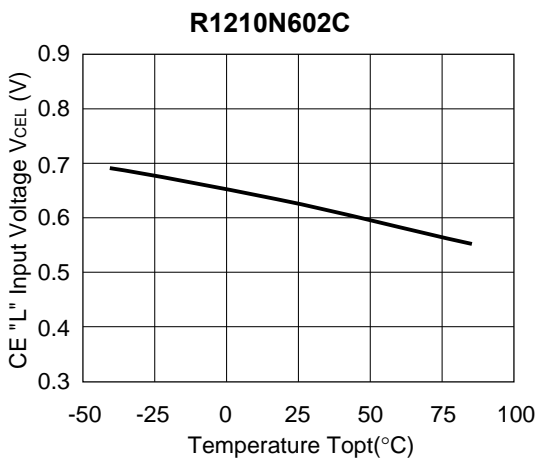

15) Output Waveform at Power-on (Topt=25°C)

((R1210N502C)) (VIN: 0V→3.0V)

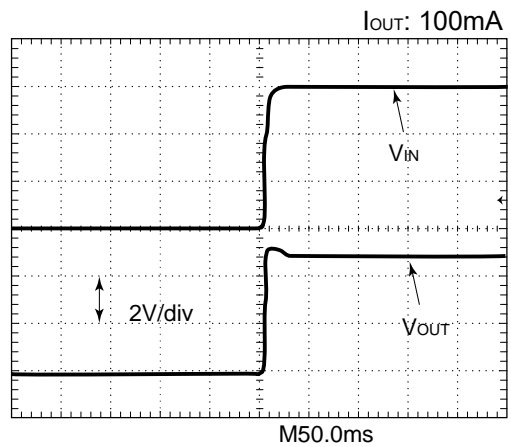
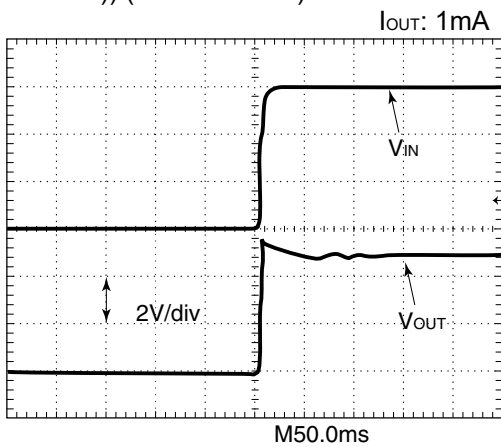

((R1210N502D)) (V_{IN} : 0V→3.0V)

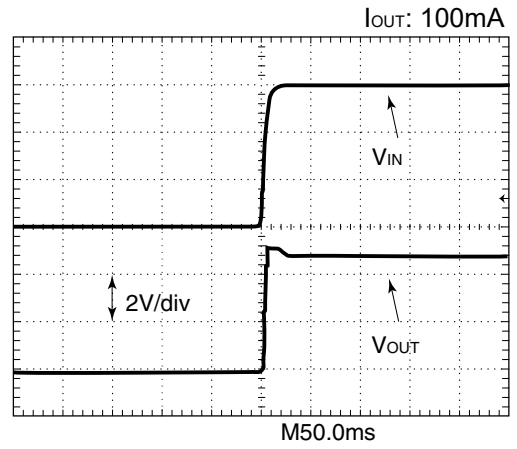
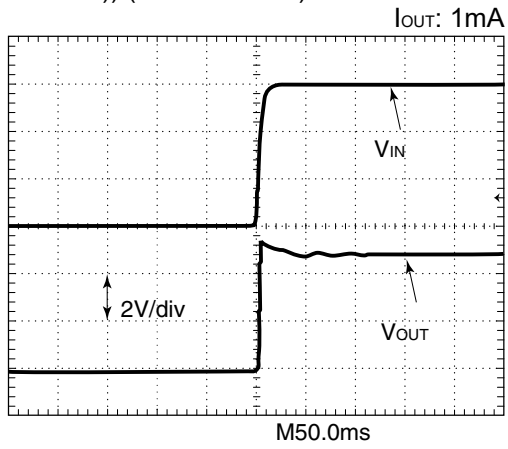

((R1210N302C)) (V_{IN} : 0V→1.5V)

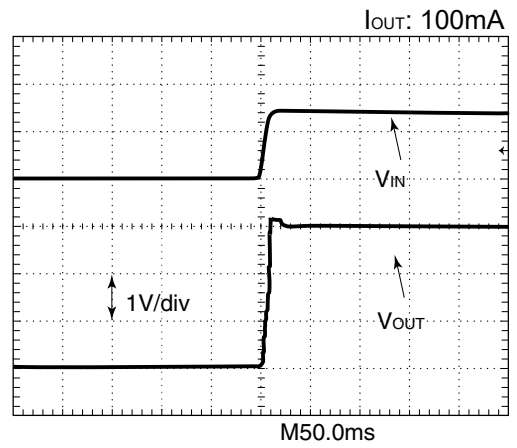
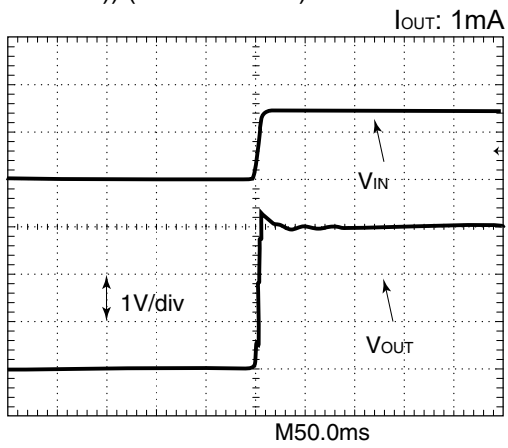

((R1210N302D)) (V_{IN} : 0V→1.5V)

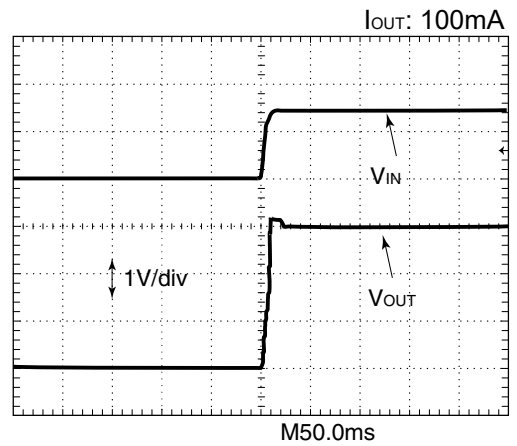
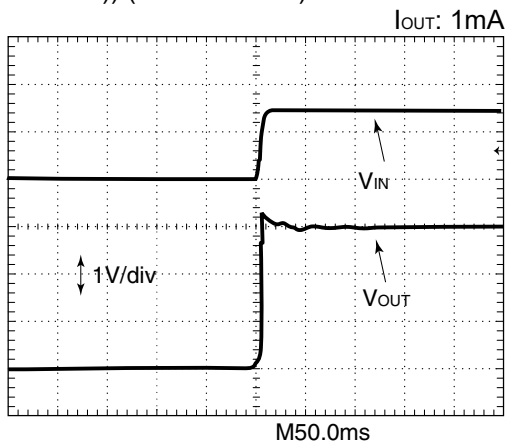

16) Load Transient Response (Topt=25°C)

((R1210N502C)) (VIN: 3.0V, IOUT: 1mA→200mA)

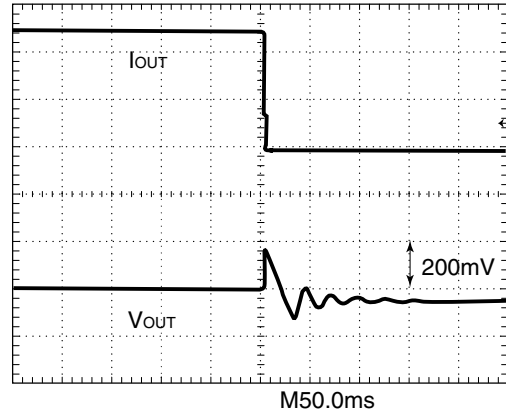
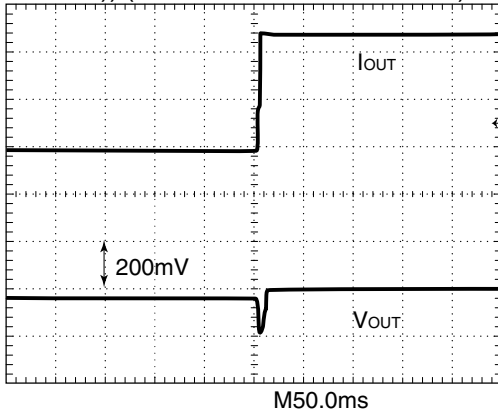

((R1210N502D)) (VIN: 3.0V, IOUT: 1mA→200mA)

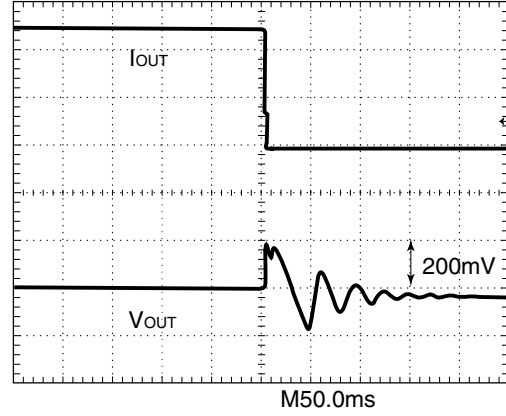
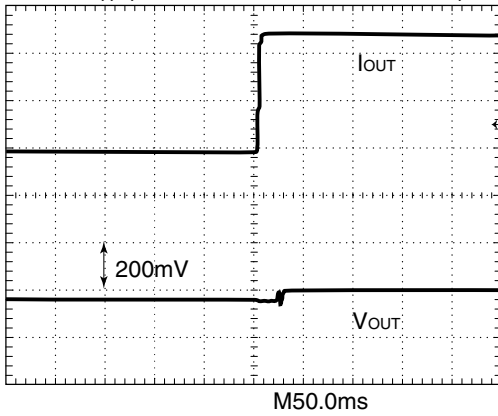

((R1210N302C)) (VIN: 1.5V, IOUT: 1mA→100mA)

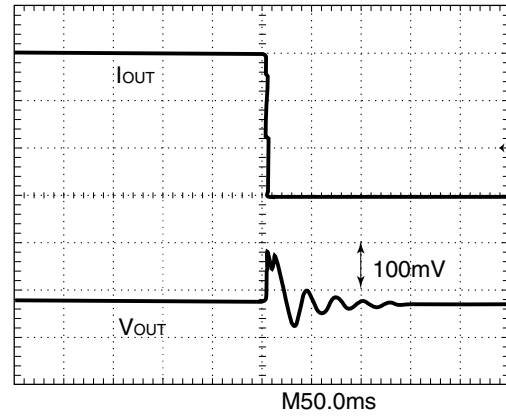
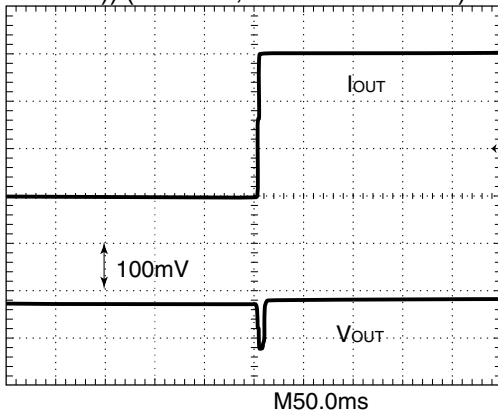

((R1210N302D)) ($V_{IN}: 1.5V, I_{OUT}: 1mA \rightarrow 100mA$)

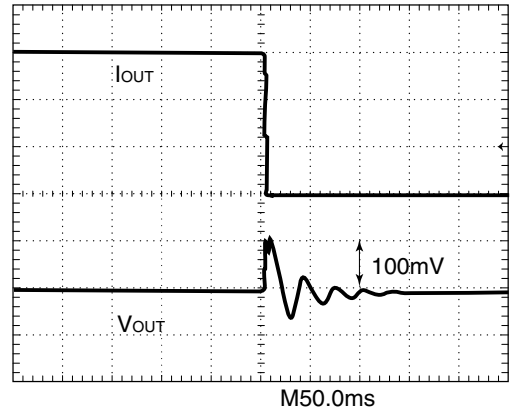
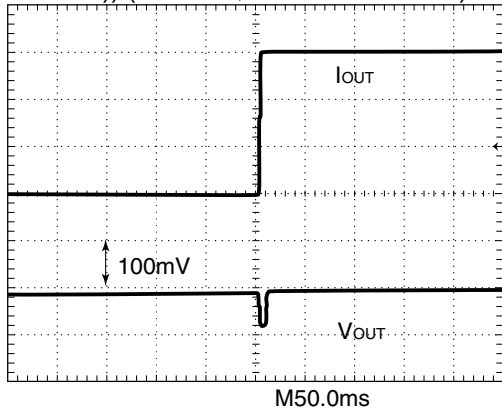



1. The products and the product specifications described in this document are subject to change or discontinuation of production without notice for reasons such as improvement. Therefore, before deciding to use the products, please refer to Ricoh sales representatives for the latest information thereon.
2. The materials in this document may not be copied or otherwise reproduced in whole or in part without prior written consent of Ricoh.
3. Please be sure to take any necessary formalities under relevant laws or regulations before exporting or otherwise taking out of your country the products or the technical information described herein.
4. The technical information described in this document shows typical characteristics of and example application circuits for the products. The release of such information is not to be construed as a warranty of or a grant of license under Ricoh's or any third party's intellectual property rights or any other rights.
5. The products listed in this document are intended and designed for use as general electronic components in standard applications (office equipment, telecommunication equipment, measuring instruments, consumer electronic products, amusement equipment etc.). Those customers intending to use a product in an application requiring extreme quality and reliability, for example, in a highly specific application where the failure or misoperation of the product could result in human injury or death (aircraft, spacevehicle, nuclear reactor control system, traffic control system, automotive and transportation equipment, combustion equipment, safety devices, life support system etc.) should first contact us.
6. We are making our continuous effort to improve the quality and reliability of our products, but semiconductor products are likely to fail with certain probability. In order to prevent any injury to persons or damages to property resulting from such failure, customers should be careful enough to incorporate safety measures in their design, such as redundancy feature, fire containment feature and fail-safe feature. We do not assume any liability or responsibility for any loss or damage arising from misuse or inappropriate use of the products.
7. Anti-radiation design is not implemented in the products described in this document.
8. The X-ray exposure can influence functions and characteristics of the products. Confirm the product functions and characteristics in the evaluation stage.
9. WLCSP products should be used in light shielded environments. The light exposure can influence functions and characteristics of the products under operation or storage.
10. There can be variation in the marking when different AOI (Automated Optical Inspection) equipment is used. In the case of recognizing the marking characteristic with AOI, please contact Ricoh sales or our distributor before attempting to use AOI.
11. Please contact Ricoh sales representatives should you have any questions or comments concerning the products or the technical information.



Ricoh is committed to reducing the environmental loading materials in electrical devices with a view to contributing to the protection of human health and the environment.

Ricoh has been providing RoHS compliant products since April 1, 2006 and Halogen-free products since April 1, 2012.

RICOH RICOH ELECTRONIC DEVICES CO., LTD.

<https://www.e-devices.ricoh.co.jp/en/>

Sales & Support Offices

Ricoh Electronic Devices Co., Ltd.

Shin-Yokohama Office (International Sales)

2-3, Shin-Yokohama 3-chome, Kohoku-ku, Yokohama-shi, Kanagawa, 222-8530, Japan
Phone: +81-50-3814-7687 Fax: +81-45-474-0074

Ricoh Americas Holdings, Inc.

675 Campbell Technology Parkway, Suite 200 Campbell, CA 95008, U.S.A.
Phone: +1-408-610-3105

Ricoh Europe (Netherlands) B.V.

Semiconductor Support Centre

Prof. W.H. Keesomlaan 1, 1183 DJ Amstelveen, The Netherlands
Phone: +31-20-5474-309

Ricoh International B.V. - German Branch

Semiconductor Sales and Support Centre

Oberrather Strasse 6, 40472 Düsseldorf, Germany
Phone: +49-211-6546-0

Ricoh Electronic Devices Korea Co., Ltd.

3F, Haesung Bldg, 504, Teheran-ro, Gangnam-gu, Seoul, 135-725, Korea
Phone: +82-2-2135-5700 Fax: +82-2-2051-5713

Ricoh Electronic Devices Shanghai Co., Ltd.

Room 403, No.2 Building, No.690 Bibo Road, Pu Dong New District, Shanghai 201203,
People's Republic of China
Phone: +86-21-5027-3200 Fax: +86-21-5027-3299

Ricoh Electronic Devices Shanghai Co., Ltd.

Shenzhen Branch

1205, Block D (Jinlong Building), Kingkey 100, Hongbao Road, Luohu District,
Shenzhen, China
Phone: +86-755-8348-7600 Ext 225

Ricoh Electronic Devices Co., Ltd.

Taipei office

Room 109, 10F-1, No.51, Hengyang Rd., Taipei City, Taiwan
Phone: +886-2-2313-1621/1622 Fax: +886-2-2313-1623