

Composite Video Amplifier

Output Capacitor-less Video Drivers



BH76806FVM, BH76809FVM, BH76812FVM, BH76816FVM

No.14064EBT02

•Description

The BH768xxFVM series video drivers are the optimum solution for high density integration systems such as, digital still cameras, mobile phones, and portable video devices. A built-in charge pump circuit eliminates the need for a large output coupling capacitor. Features include: a built-in LPF, low-voltage (2.5 V) operation, and 0 μ A current consumption during standby mode.

•Features

- 1) Select from four video driver amp gain settings: 6 dB, 9 dB, 12 dB, and 16.5 dB
- 2) Large-output video driver with maximum output voltage of 5.2 V_{P-P}
Supports wide and low-voltage operation range.
- 3) No output coupling capacitor is needed, which makes for a more compact design
- 4) Built-in standby function sets circuit current to 0 μ A (typ.) during standby mode
- 5) Clear image reproduction by on-chip 8-order 4.5-MHz LPF (Low Pass Filter)
- 6) Bias input method is used to support chroma, video, and RGB signals.
- 7) MSOP8 compact package

•Applications

Mobile telephones, DSCs (digital still cameras), DVCs (digital video cameras), portable game systems, portable media players, etc.

•Line up matrix

Part No.	Video driver amp gain	Recommended input level
BH76806FVM	6dB	1 V_{P-P}
BH76809FVM	9dB	0.7 V_{P-P}
BH76812FVM	12dB	0.5 V_{P-P}
BH76816FVM	16.5dB	0.3 V_{P-P}

•Absolute maximum ratings (Ta=25°C)

Parameter	Symbol	Ratings	Unit
Supply voltage	VCC	3.55	V
Power dissipation	Pd	0.47	W
Operating temperature range	T _{opr}	-40 to +85	°C
Storage temperature range	T _{stg}	-55 to +125	°C

* Reduce by 4.7 mW/°C over 25°C, when mounted on a 70mmx70mmx1.6mm PCB board.

●Operating range (Ta=25°C)

Parameter	Symbol	Min.	TYP.	Max.	Unit
Supply voltage	VCC	2.5	3.0	3.45	V

●Electrical characteristics (Unless otherwise noted, Typ.: Ta=25°C, VCC=3V)

Parameter	Symbol	Typical value				Unit	Conditions
		BH76806 FVM	BH76809 FVM	BH76812 FVM	BH76816 FVM		
Circuit current 1	I _{CC1}	16		15		mA	No signal
Circuit current 2	I _{CC2}	0.0				μA	Standby mode
Standby SW input current High-Level	I _{thH}	45				μA	When 3.0 V is applied to 4pin
Standby switching voltage High-Level	V _{thH}	(min.) 1.2				V	standby OFF
Standby Switching voltage Low-Level	V _{thL}	(max.) 0.45				V	standby ON
Video driver amp gain	G _V	6.0	9.0	12.0	16.5	dB	V _o =100kHz, 1.0V _{P-P}
Maximum output level	V _{omv}	5.2				V _{P-P}	f=1kHz, THD=1%
Frequency characteristic 1	G _{f1}	-0.45				dB	f=4.5MHz/100kHz
Frequency characteristic 2	G _{f2}	-3.0				dB	f=8.0MHz/100kHz
Frequency characteristic 3	G _{f3}	-32				dB	f=18MHz/100kHz
Frequency characteristic 4	G _{f4}	-51				dB	f=23.5MHz/100kHz
Differential Gain	D _G	0.5				%	V _o =1.0V _{P-P} Standard stair step signal
Differential Phase	D _P	1.0				deg	V _o =1.0V _{P-P} Standard stair step signal
Y signal output S/N	SN _Y	+74	+73	+70	+70	dB	Band = 100k to 6MHz 75 Ω termination 100% chroma video signal
C signal output S/N (AM)	SN _{CA}	+77	+76	+75	+75	dB	Band = 100 to 500kHz 75Ωtermination 100%chroma video signal
C signal output S/N (PM)	SN _{CP}	+65				dB	Band = 100 to 500kHz 75Ωtermination 100%chroma video signal
Output pin source current	I _{extin}	30				mA	4.5 V applied via 150 Ω to output pin
Output DC offset voltage	V _{off}	(max.) ±50				mV	75 Ω termination

●Measurement circuit

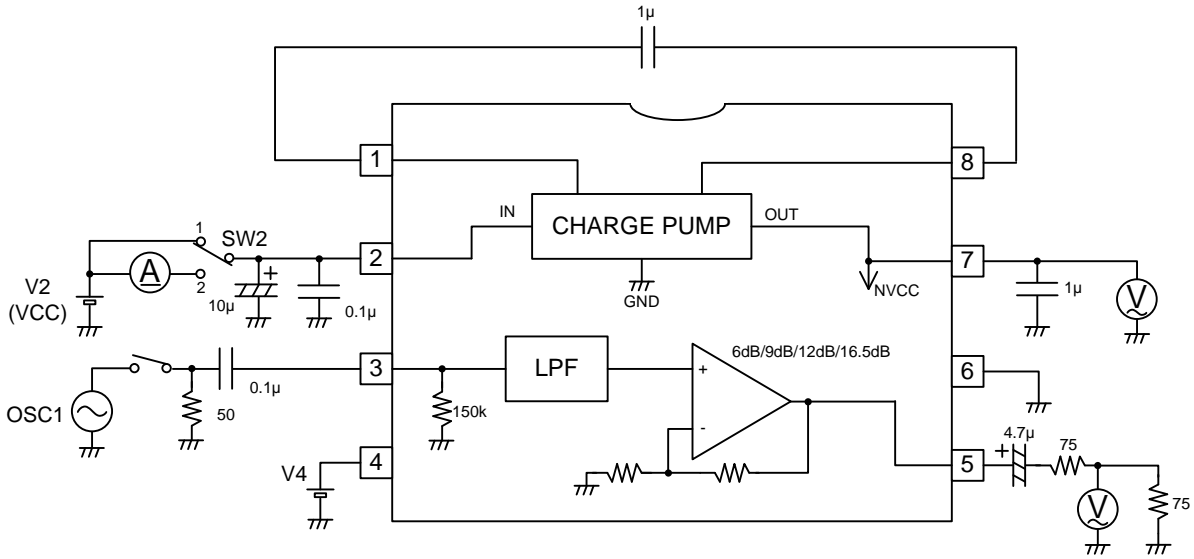

※ Test circuit is intended for shipment inspections, and differs from application circuit.

Fig. 1

●Control pin settings

Parameter	States	Note
Standby control	STBY(4pin)=H	STBY:OFF
	STBY(4pin)=L	STBY:ON
	STBY(4pin)=OPEN	STBY:ON

●Block diagram

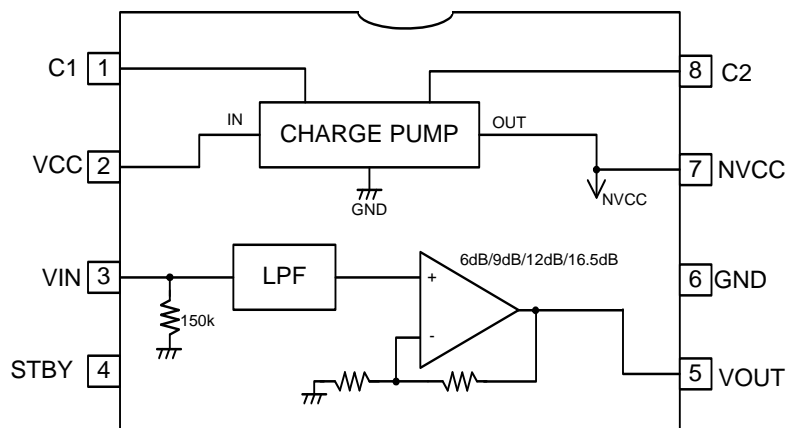

Fig. 2

•Pin descriptions

Pin No.	Pin name	equivalent circuit	DC voltage	Functions						
1	C1		+VCC ↑↓ 0V	Flying capacitor "+" pin See function description for pins 7 and 8						
2	VCC	/	VCC	VCC Pin						
3	VIN		0V	Video signal input pin Adaptive input signal Composite video signal/ chroma signal/RGB signal, etc.						
4	STBY		VCC to 0V	STANBY control Pin <table border="1"> <thead> <tr> <th>Terminal Voltage</th> <th>MODE</th> </tr> </thead> <tbody> <tr> <td>1.2V to VCC (H)</td> <td>STBY:OFF</td> </tr> <tr> <td>0V to 0.45V (L)</td> <td>STBY:ON</td> </tr> </tbody> </table>	Terminal Voltage	MODE	1.2V to VCC (H)	STBY:OFF	0V to 0.45V (L)	STBY:ON
Terminal Voltage	MODE									
1.2V to VCC (H)	STBY:OFF									
0V to 0.45V (L)	STBY:ON									
5	VOUT		0V	Video signal output pin 75Ω						
6	GND		0V	GND Pin						

* 1 The DC voltage in the figure is VCC = 3.0 V. These values are for reference only and are not guaranteed.
 * 2 These values are for reference only and are not guaranteed.

•Pin descriptions

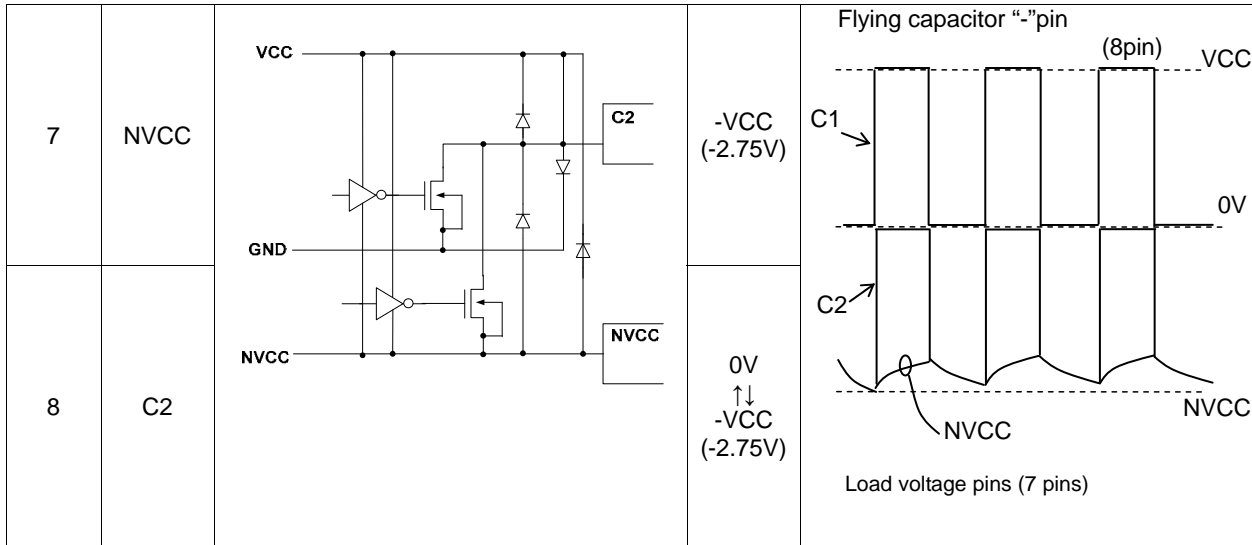

- * 1 The DC voltage in the figure is VCC = 3.0 V. These values are for reference only and are not guaranteed.
- * 2 These values are for reference only and are not guaranteed.

•Description of operations

1) Principles of video driver with no output coupling capacitor

Amp (Single power supply)

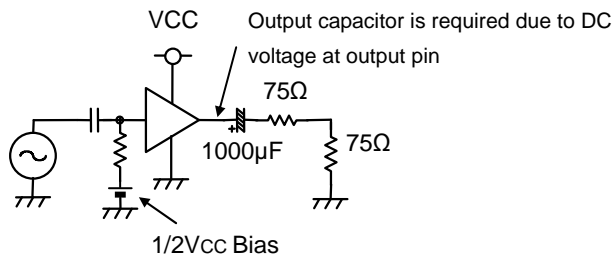

Fig.3

Amp (Dual power supply)

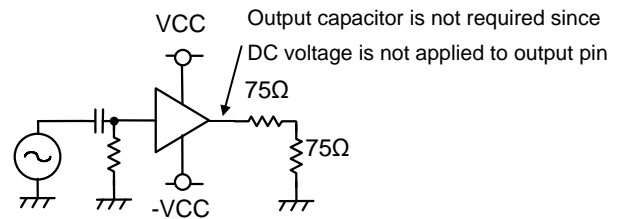

Fig.4

When the amplifier operates using single voltage power supply, the operating potential point is approximately 1/2 Vcc. Therefore, a coupling capacitor is required to prevent DC output. For the video driver, the load resistance is 150 Ω (75 Ω + 75 Ω). Therefore, the coupling capacitor should be about 1000 µF when a low bandwidth for transmission is considered. (See Figure 3.)

When the amplifier operates using a dual (±) power supply, the operating point can be set at GND level, and therefore, there is no need for a coupling capacitor to prevent DC output. Since a coupling capacitor is not needed, there is no sagging of low-frequency characteristics in output stage. (See Figure 4.)

2) Generation of negative voltage by charge pump circuit

As is shown in Figure 5, the charge pump consists of a pair of switches (SW1 and SW2) and a pair of capacitors (flying capacitor and load capacitor), generating a negative voltage. When +3 V is applied to this IC, approximately -2.83 V of negative voltage is obtained.

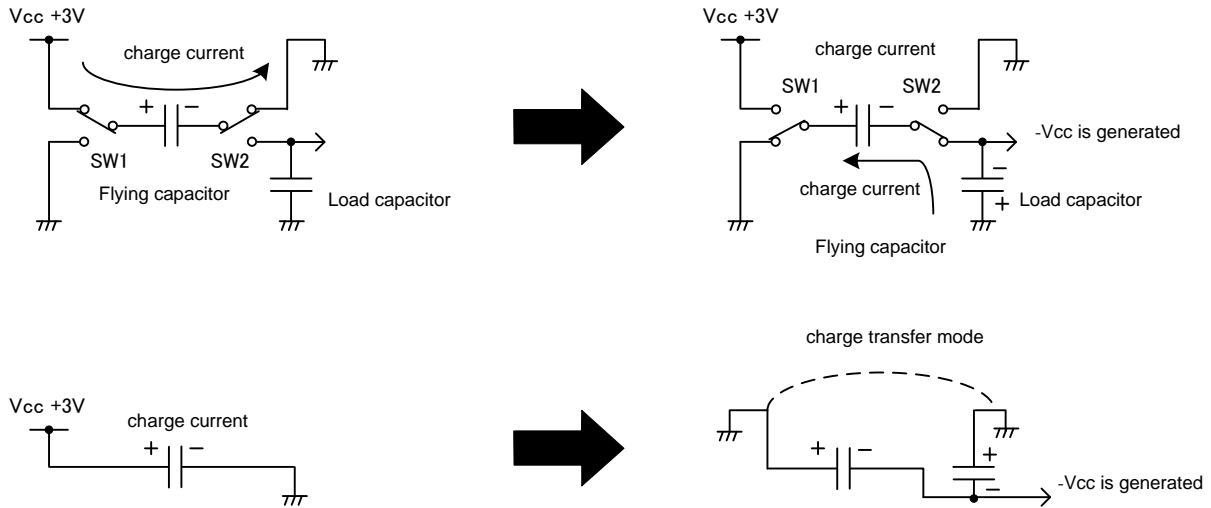

Fig. 5 Principles of Charge Pump Circuit

1) Configuration of BH768xxFVM Series

As is shown in Figure 6, in the BH768xxFVM Series, a dual power supply amplifier is integrated with a charge pump circuit in the same IC. This enables operation using a +3V single power supply while also using a dual power supply amplifier, which eliminates the need for an output coupling capacitor.

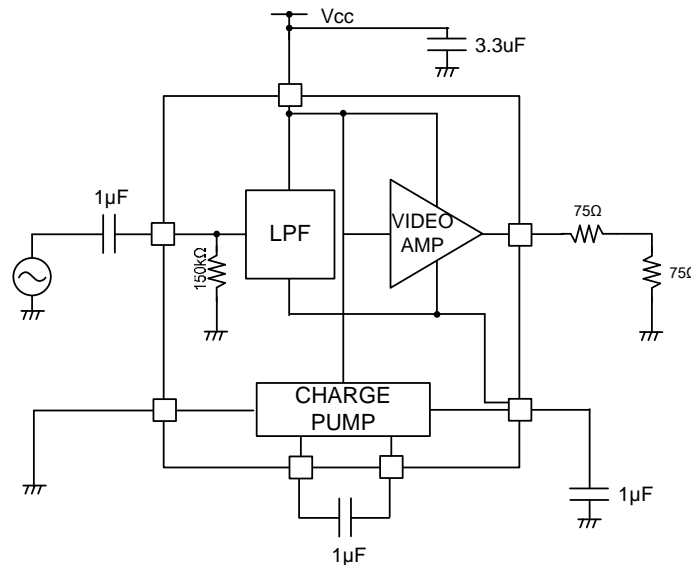

Fig. 6 BH768xxFVM Configuration Diagram

2) Input terminal type and sag characteristics

BH768xxFVM Series devices provide both a low-voltage video driver and a large dynamic range (approximately $5.2 V_{P-P}$). A resistance termination method (150 k Ω termination) is used instead of the clamp method, which only supports video signals, since it supports various signal types.

The BH768xxFVM series supports a wide range of devices such as, video signals, chroma signals, and RGB signals that can operate normally even without a synchronization signal.

In addition, input terminating resistance (150 k Ω) can use a small input capacitor without reducing the sag low-band. It is recommended to use a H-bar signal when evaluating sag characteristics, since it makes sag more noticeable. (See Figures 7 to 10.)

Sag is determined by input capacitor and input resistance only.

Cut-off frequency for input capacitor and input impedance is the same as when the output capacitor is set at 1000 μF with an ordinary 75 Ω driver.

$1 \mu\text{F} \times 150 \text{K}\Omega = 1000 \mu\text{F} \times 150 \Omega$
 (Input terminal time constant) (Output terminal time constant)

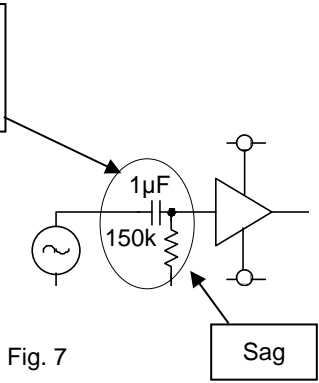
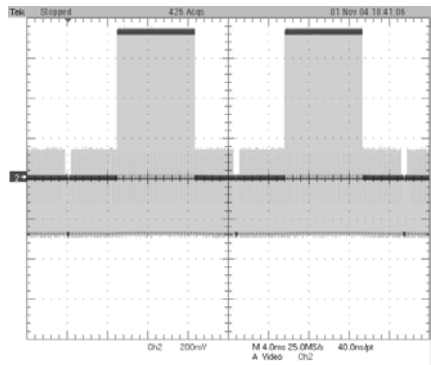

Fig. 7

a) Sag-free TV Test Signal Generator Output(Sibasoku TG-7/1 , H-bar)



H-bar signal's TV screen output image

Fig. 8

b) BH768xxFVM output (input = 1.0 μF , output, H-bar)

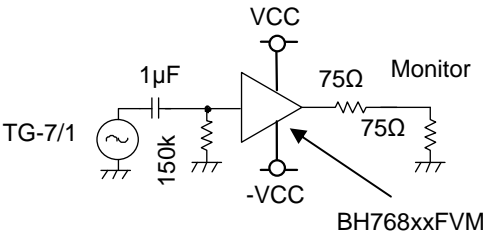
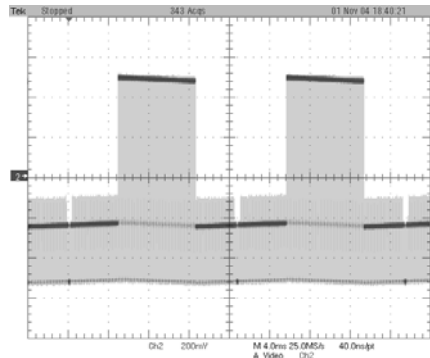

Fig. 9

Nearly identical sag characteristics

c) 1000 μF + 150 Ω sag waveform (TV Test Signal Generator Sibasoku TG-7/1 output, H-bar)

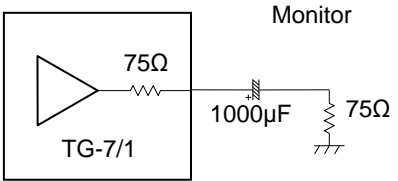
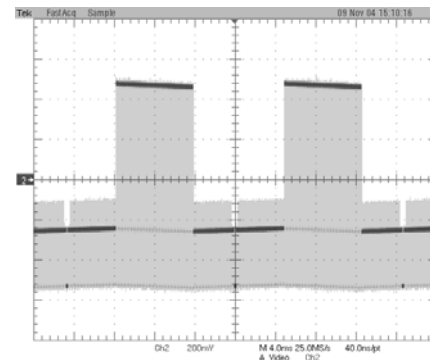

Fig. 10

1) Decoupling capacitor only

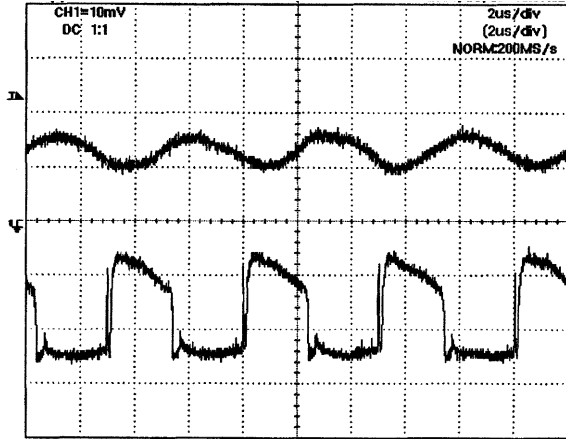
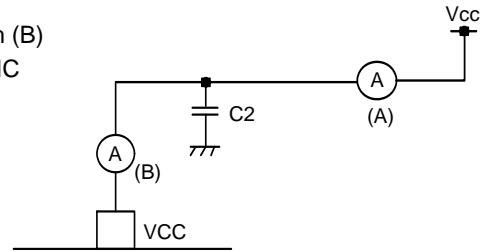

Fig.13

Current waveform (A)
between single power supply and C2
10mA/div

Current waveform (B)
between C2 and IC
10mA/div



2) Decoupling capacitor + Resistance 10Ω

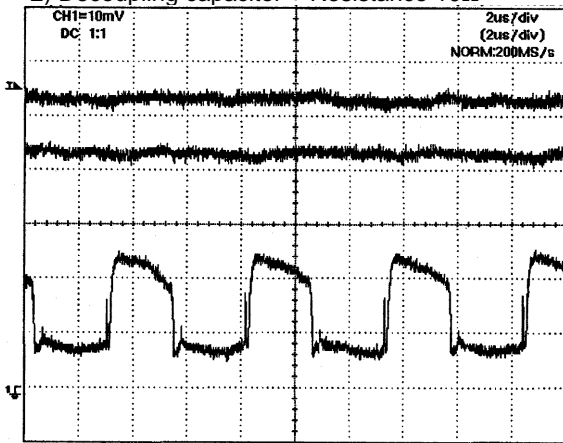
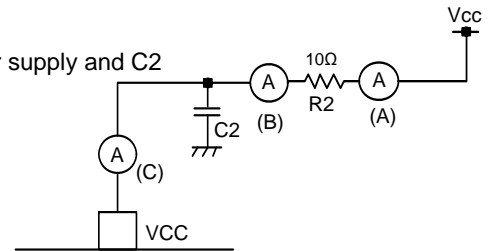

Fig.14

Current waveform (A)
between single power supply and R2
10mA/div

Current waveform (B)
between R2 and C2
10mA/div

Current waveform (C)
between single power supply and C2
10mA/div



•Pattern diagram of evaluation board

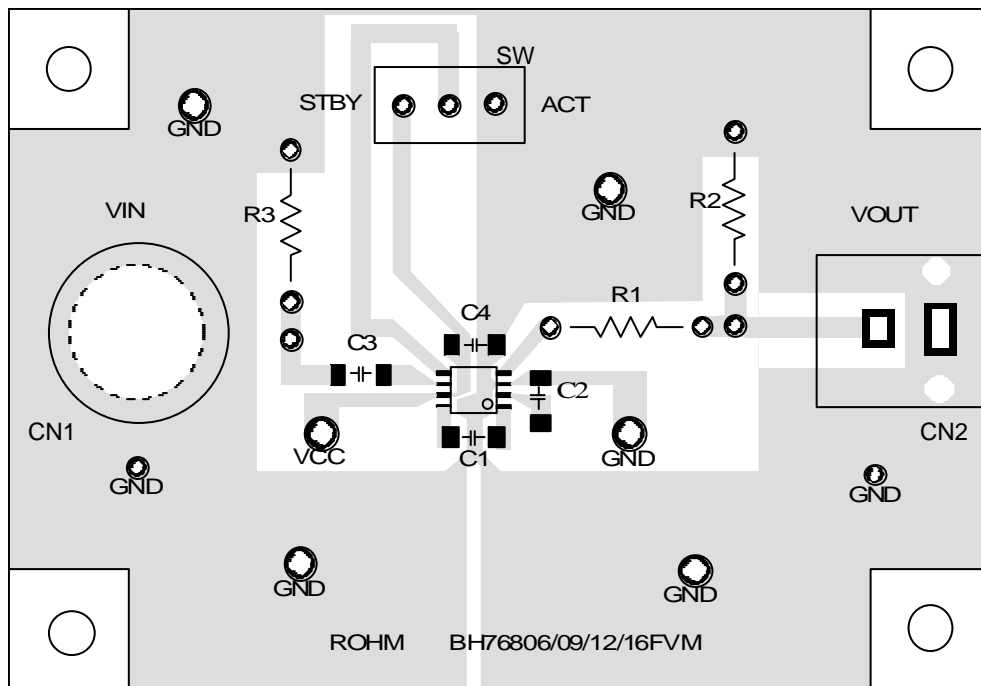

•List of external components

Fig. 15

Symbol	Function	Recommended value	Remark
C1	Flying capacitor	1 μ F	B characteristics are recommended
C2	Tank capacitor	1 μ F	B characteristics are recommended
C3	Input coupling capacitor	1 μ F	B characteristics are recommended
C4	Decoupling capacitor	3.3 μ F	B characteristics are recommended
R1	Output resistor	75 Ω	—
R2	Output terminating resistance	75 Ω	Not required when connecting to TV or video signal test equipment.
R3	Input terminating resistance	75 Ω	Required when connecting to video signal test equipment.
CN1	Input connector	BNC	
CN2	Output connector	RCA (pin jack)	
SW	STBY control	SW	

●Reference data

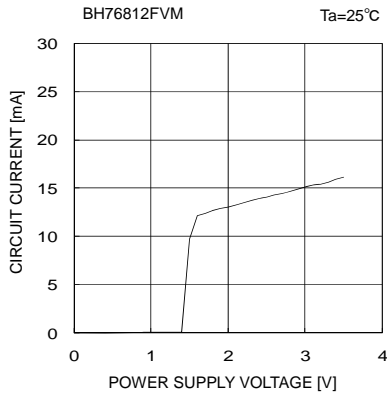

Fig. 16 Circuit current vs. Supply voltage

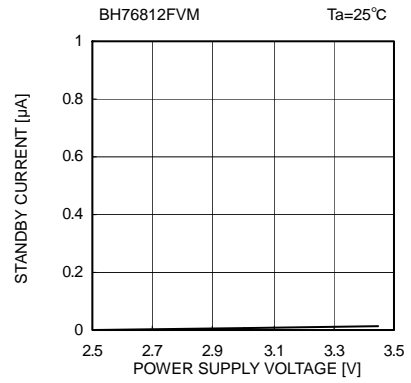

Fig. 17 Circuit Current (Standby) vs. Supply Voltage

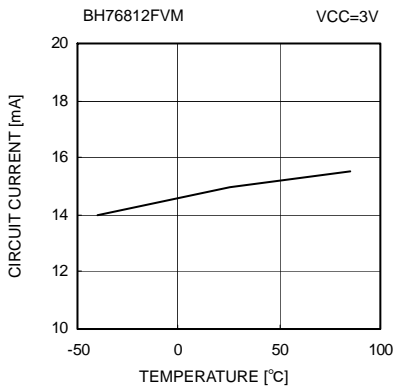

Fig. 18 Circuit current vs. Temperature

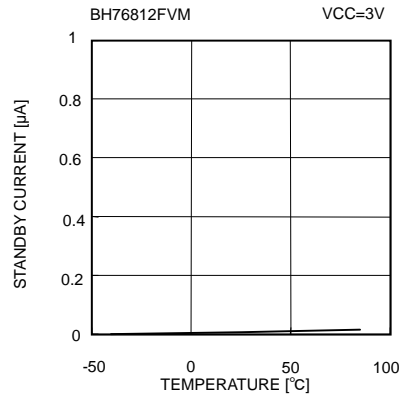

Fig. 19 Circuit Current (Standby) vs. Temperature

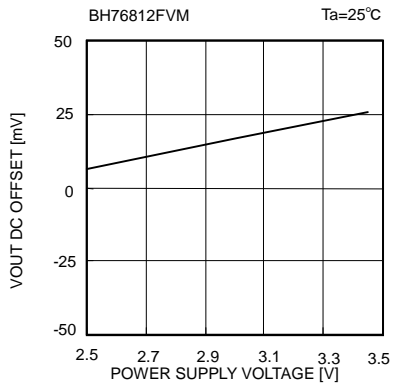

Fig. 20 VOUT DC offset voltage vs. Supply voltage

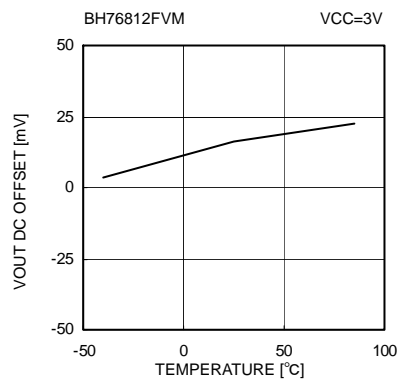

Fig. 21 VOUT DC offset voltage vs. Temperature

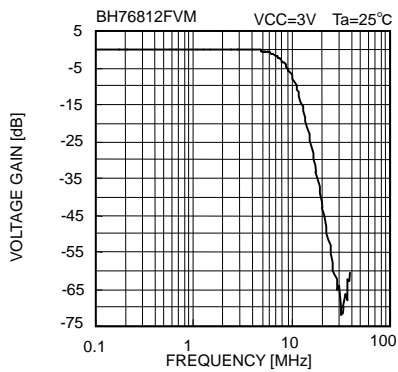

Fig. 22 Frequency characteristic

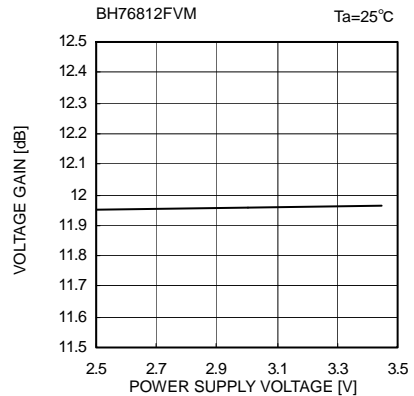

Fig. 23 Voltage gain vs. Supply voltage

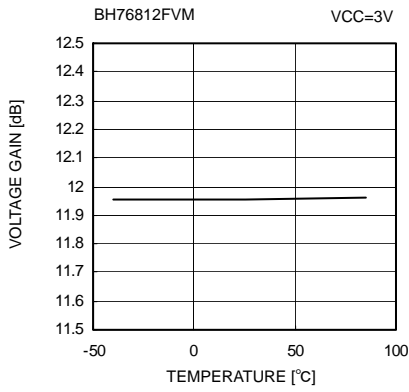

Fig. 24 Voltage gain vs. Temperature

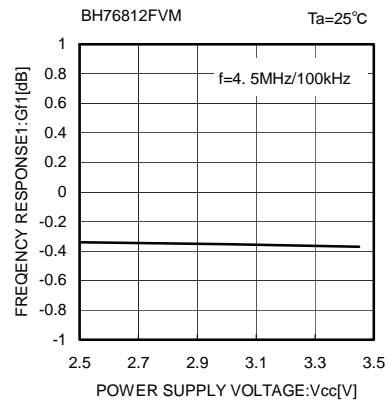

Fig. 25 Frequency response 1 vs. Supply voltage

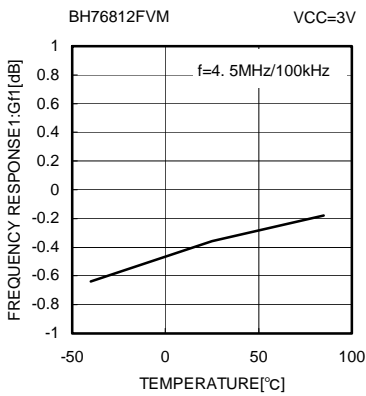

Fig. 26 Frequency response 1 vs. Temperature

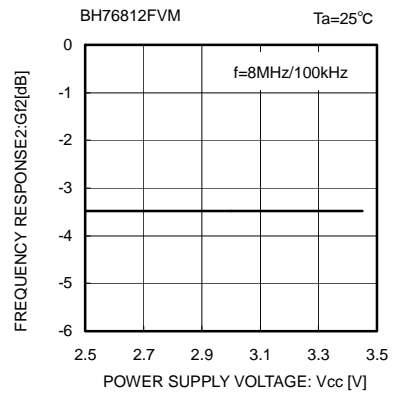

Fig. 27 Frequency response 2 vs. Supply voltage

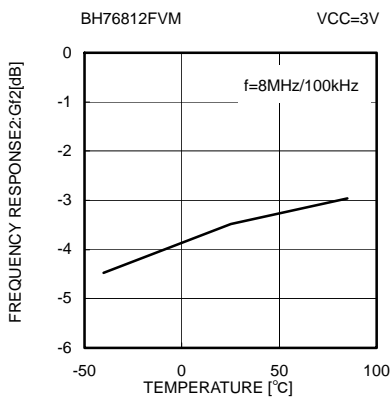

Fig. 28 Frequency response 2 vs. Temperature

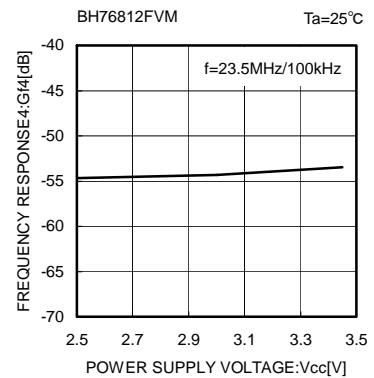

Fig. 29 Frequency response 4 vs. Supply voltage

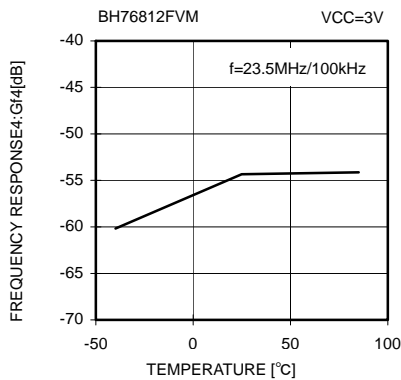

Fig. 30 Frequency response 4 vs. Temperature

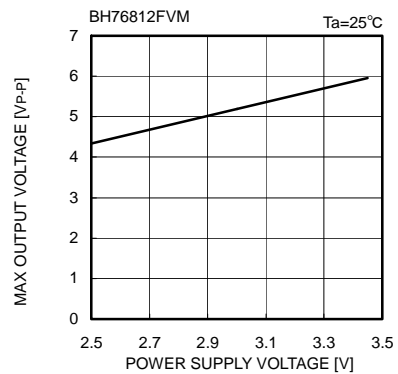

Fig. 31 Maximum output voltage level vs. Supply voltage

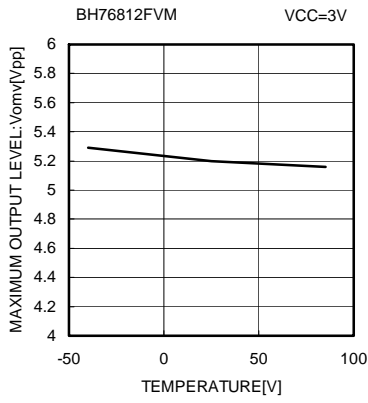

Fig. 32 Maximum output level vs. Temperature

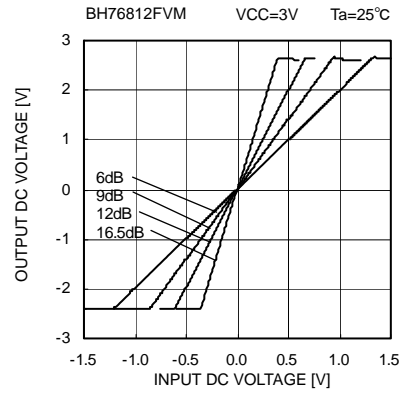

Fig. 33 Output DC voltage – Input DC voltage

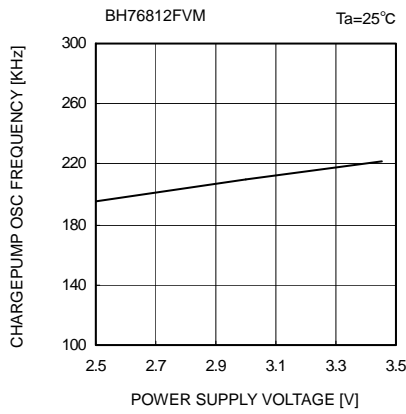

Fig. 34 Charge pump oscillation frequency vs. Supply voltage

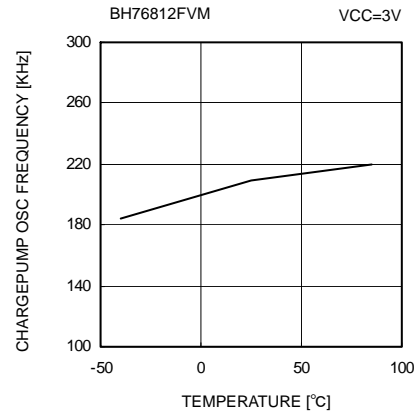

Fig. 35 Charge pump oscillation frequency vs. Temperature

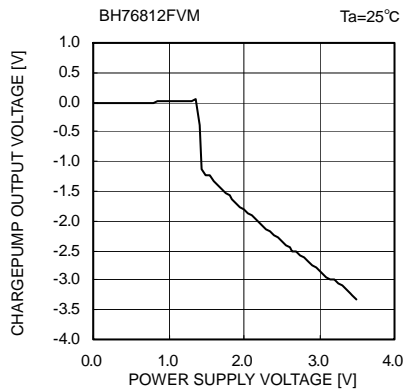

Fig. 36 Charge pump output voltage vs. Supply voltage

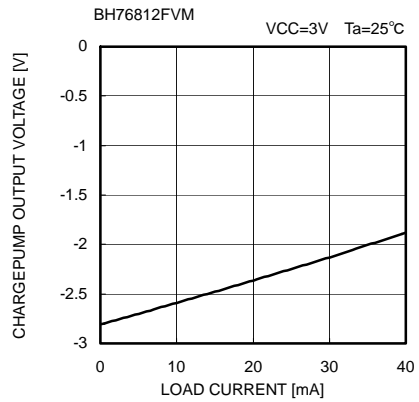

Fig. 37 Charge pump load regulation

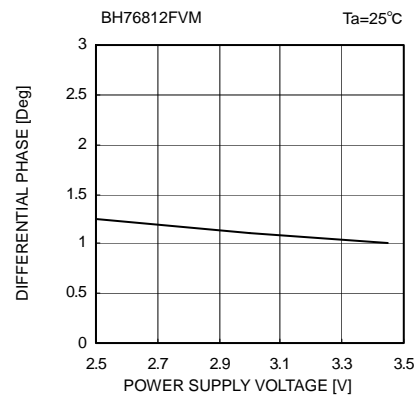

Fig. 38 Differential phase vs. Supply voltage

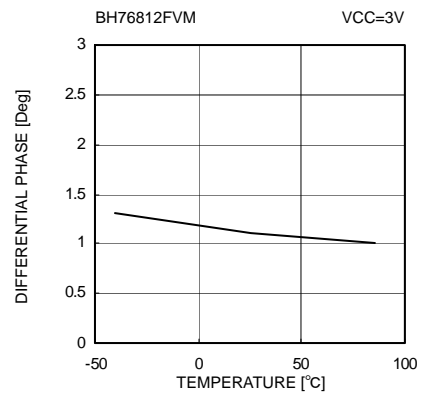

Fig. 39 Differential phase vs. Temperature

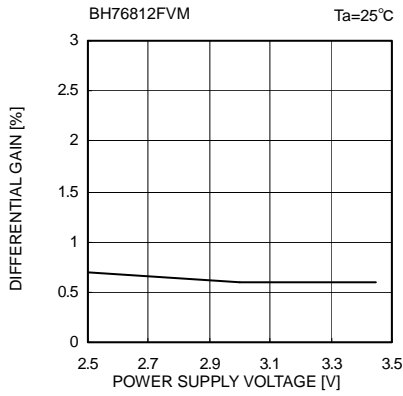

Fig. 40 Differential gain vs. Supply voltage

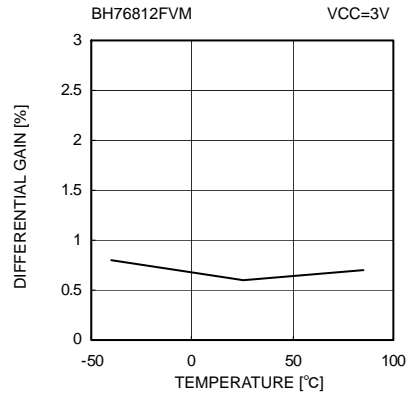

Fig. 41 Differential gain vs. Temperature

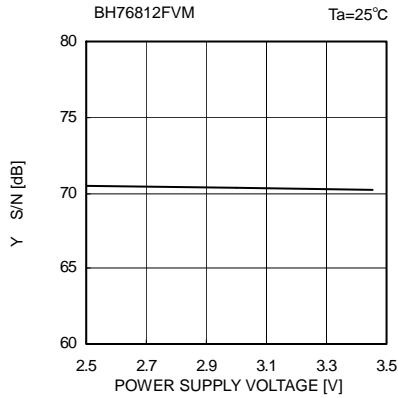

Fig. 42 S/N(Y) vs. Supply Voltage

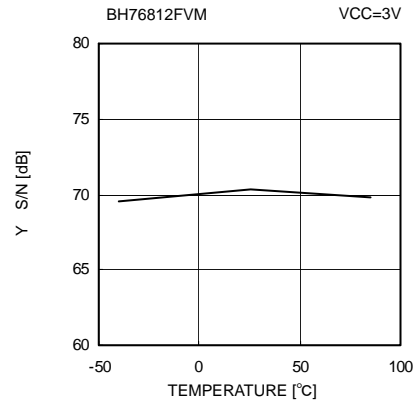

Fig. 43 S/N(Y) vs. Temperature

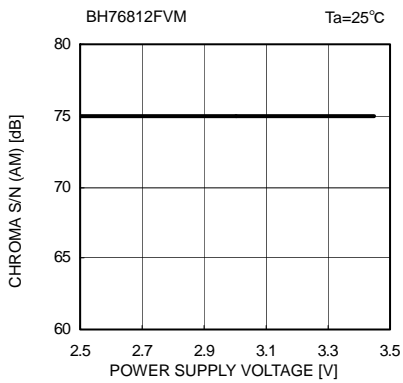

Fig. 44 S/N(C-AM) vs. Supply Voltage

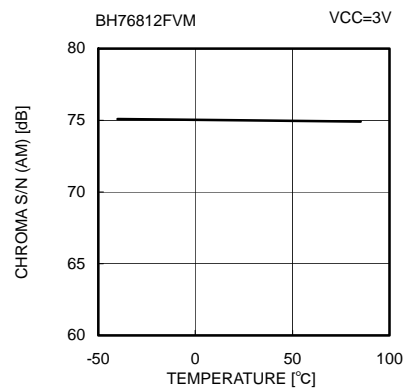

Fig. 45 S/N(C-AM) vs. Temperature

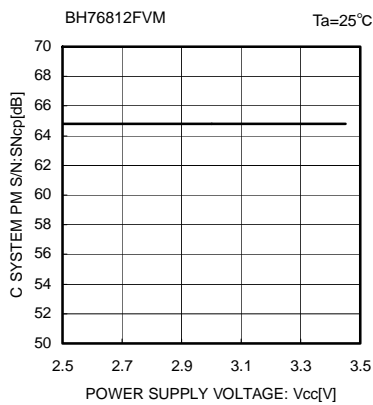

Fig. 46 S/N(C-PM) vs. Supply Voltage

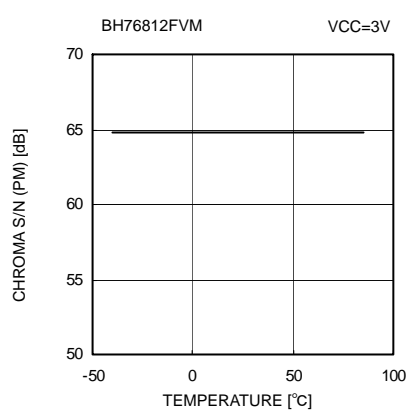

Fig. 47 S/N(C-PM) vs. Temperature

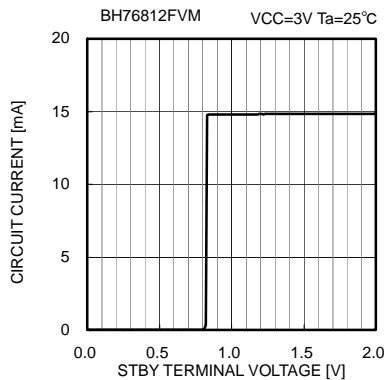

Fig. 48 Circuit current vs. STBY terminal voltage

●Cautions on use

1. Numbers and data in entries are representative design values and are not guaranteed values of the items.
2. Although ROHM is confident that the example application circuit reflects the best possible recommendations, be sure to verify circuit characteristics for your particular application. Modification of constants for other externally connected circuits may cause variations in both static and transient characteristics for external components as well as this Rohm IC. Allow for sufficient margins when determining circuit constants.
3. Absolute maximum ratings

Use of the IC in excess of absolute maximum ratings, such as the applied voltage or operating temperature range (Topr), may result in IC damage. Assumptions should not be made regarding the state of the IC (short mode or open mode) when such damage is suffered. A physical safety measure, such as a fuse, should be implemented when using the IC at times where the absolute maximum ratings may be exceeded.
4. Thermal design

Perform thermal design, in which there are adequate margins, by taking into account the permissible dissipation (Pd) in actual states of use.
5. Short circuit between terminals and erroneous mounting

Pay attention to the assembly direction of the ICs. Wrong mounting direction or shorts between terminals, GND, or other components on the circuits, can damage the IC.
6. Operation in strong electromagnetic field

Using the ICs in a strong electromagnetic field can cause operation malfunction.
7. Wiring from the decoupling capacitor C2 to the IC should be kept as short as possible.

This capacitance value may have ripple effects on the IC, and may affect the S-N ratio. It is recommended to use as large a decoupling capacitor as possible. (Recommendations: 3.3 μ F, B characteristics, 6.3 V or higher)
8. Target capacitor

It is recommended to use a ceramic capacitor with good temperature characteristics (B).
9. The NVCC (7 pin) terminal generates a voltage that is used within the IC, so it should not be connected to a load unless necessary. This capacitor (C7) has a large capacitance value with low negative voltage ripple.
10. Capacitors C18 and C2 should be placed as close as possible to the IC. If the wire length to the capacitor is too long, it can lead to switching noise. (Recommended C18: 1.0 μ F; C2: 3.3 μ F, B characteristics, 6.3 V or higher maximum voltage)
11. The HPF consists of input coupling capacitor C3 and 150 k Ω of the internal input.

Be sure to check for video signal sag before determining the C3 value.

The cut-off frequency f_c can be calculated using the following formula.

$$f_c = 1/(2\pi \times C3 \times 150 \text{ k}\Omega)$$
 (Recommendations: 1.0 μ F, B characteristics, 6.3 V or higher maximum voltage)
12. The output resistor R5 should be placed close to the IC.
13. Improper mounting may damage the IC.
14. A large current transition occurs in the power supply pin when the charge pump circuit is switched. If this affects other ICs (via the power supply line), insert a resistor (approximately 10 Ω) in the VCC line to improve the power supply's ripple effects. Although inserting a 10 Ω resistor lowers the voltage by about 0.2 V, this IC has a wide margin for low-voltage operation, so dynamic range problems or other problems should not occur. (See Figures 12 to 14.)

●Selection of order type

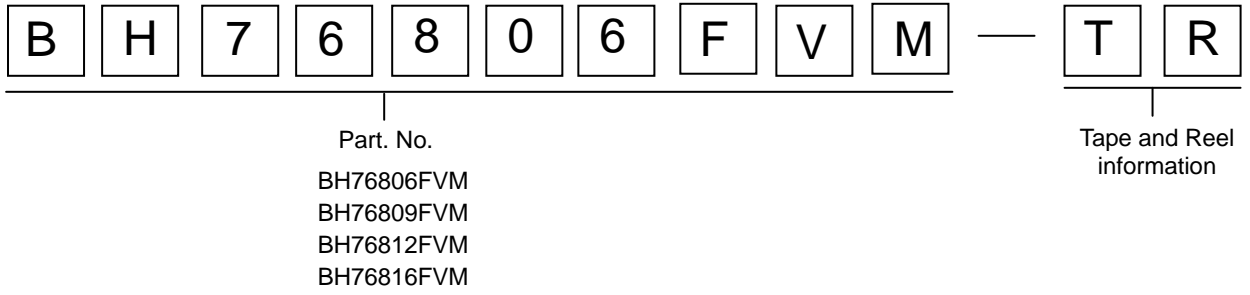

MSOP8

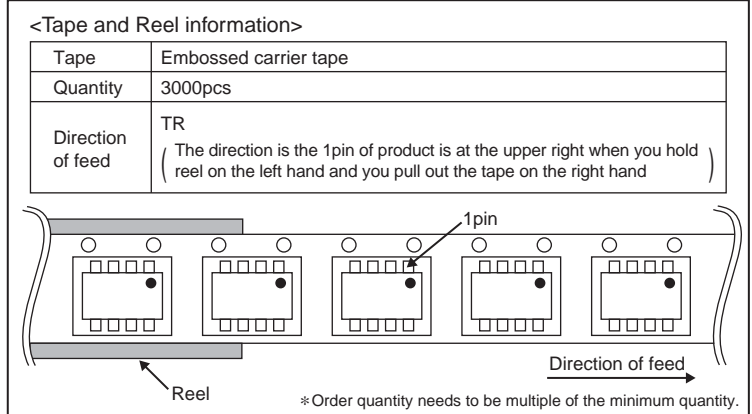
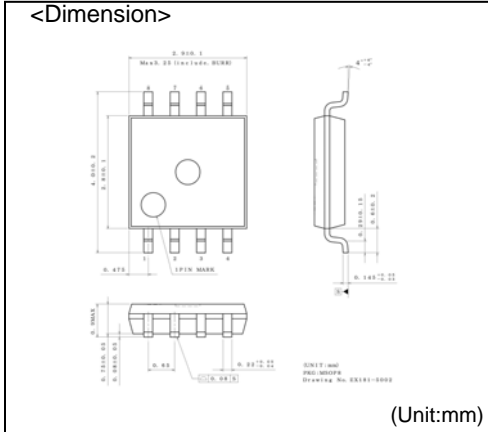

Notes

- 1) The information contained herein is subject to change without notice.
- 2) Before you use our Products, please contact our sales representative and verify the latest specifications :
- 3) Although ROHM is continuously working to improve product reliability and quality, semiconductors can break down and malfunction due to various factors.
Therefore, in order to prevent personal injury or fire arising from failure, please take safety measures such as complying with the derating characteristics, implementing redundant and fire prevention designs, and utilizing backups and fail-safe procedures. ROHM shall have no responsibility for any damages arising out of the use of our Products beyond the rating specified by ROHM.
- 4) Examples of application circuits, circuit constants and any other information contained herein are provided only to illustrate the standard usage and operations of the Products. The peripheral conditions must be taken into account when designing circuits for mass production.
- 5) The technical information specified herein is intended only to show the typical functions of and examples of application circuits for the Products. ROHM does not grant you, explicitly or implicitly, any license to use or exercise intellectual property or other rights held by ROHM or any other parties. ROHM shall have no responsibility whatsoever for any dispute arising out of the use of such technical information.
- 6) The Products are intended for use in general electronic equipment (i.e. AV/OA devices, communication, consumer systems, gaming/entertainment sets) as well as the applications indicated in this document.
- 7) The Products specified in this document are not designed to be radiation tolerant.
- 8) For use of our Products in applications requiring a high degree of reliability (as exemplified below), please contact and consult with a ROHM representative : transportation equipment (i.e. cars, ships, trains), primary communication equipment, traffic lights, fire/crime prevention, safety equipment, medical systems, servers, solar cells, and power transmission systems.
- 9) Do not use our Products in applications requiring extremely high reliability, such as aerospace equipment, nuclear power control systems, and submarine repeaters.
- 10) ROHM shall have no responsibility for any damages or injury arising from non-compliance with the recommended usage conditions and specifications contained herein.
- 11) ROHM has used reasonable care to ensure the accuracy of the information contained in this document. However, ROHM does not warrant that such information is error-free, and ROHM shall have no responsibility for any damages arising from any inaccuracy or misprint of such information.
- 12) Please use the Products in accordance with any applicable environmental laws and regulations, such as the RoHS Directive. For more details, including RoHS compatibility, please contact a ROHM sales office. ROHM shall have no responsibility for any damages or losses resulting from non-compliance with any applicable laws or regulations.
- 13) When providing our Products and technologies contained in this document to other countries, you must abide by the procedures and provisions stipulated in all applicable export laws and regulations, including without limitation the US Export Administration Regulations and the Foreign Exchange and Foreign Trade Act.
- 14) This document, in part or in whole, may not be reprinted or reproduced without prior consent of ROHM.



Thank you for your accessing to ROHM product informations.
More detail product informations and catalogs are available, please contact us.

ROHM Customer Support System

<http://www.rohm.com/contact/>