

Load Switch ICs

2.0A Current Load Switch ICs for Portable Equipment

BD6520F BD6522F

General Description

BD6520F and BD6522F are power management switches (N-Channel Power MOSFET) with an ON-Resistance of 50mΩ (Typ). An internal charge pump drives the gate of the N-Channel Power MOSFET. Also, an external capacitor can be connected to the soft start control terminal, thus achieving reduction of the inrush current to the load capacitor during turn on. Furthermore, these ICs have undervoltage lockout, thermal shutdown and a discharge circuit for the capacitive load at switch OFF.

Key Specifications

- Input Voltage Range: 3.0V to 5.5V
- ON-Resistance:
 - R_{ON1} (at V_{DD} = 5V BD6520F, BD6522F) 50mΩ (Typ)
 - R_{ON2} (at V_{DD} = 3V BD6520F) 60mΩ (Typ)
 - R_{ON2} (at V_{DD} = 3.3V BD6522F) 60mΩ (Typ)
- Continuous Current: 2.0 A
- Operating Temperature Range: -25°C to +85°C

Package

W (Typ) D (Typ) H (Max)

Features

- Low ON-Resistance (50mΩ, Typ) NMOS Switch
- Maximum Output Current: 2A
- Discharge Circuit
- Soft Start Control
- Undervoltage Lockout (UVLO)
- Thermal Shutdown (Output OFF Latching)
- Reverse Current Flow Blocking at Switch OFF (Only in BD6522F)

Applications

Notebook PCs
PC Peripheral Devices

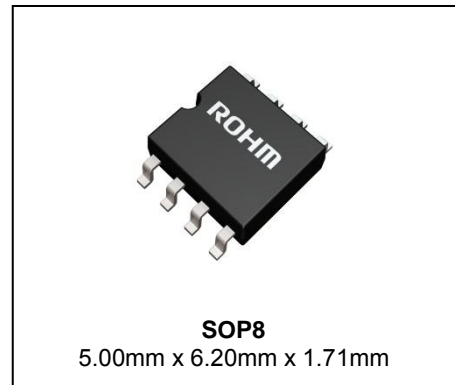

Typical Application Circuit

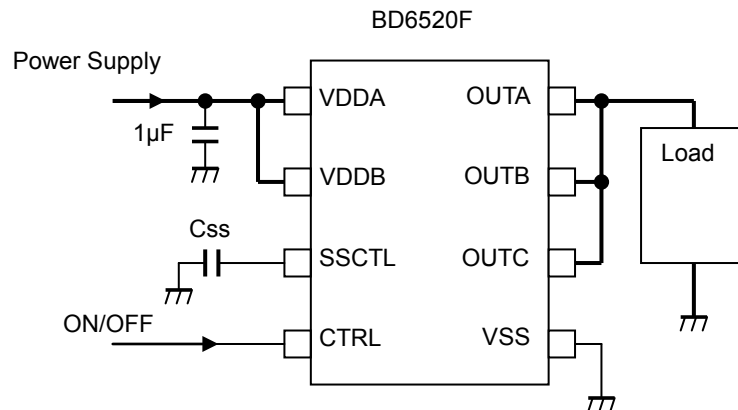

Lineup

OUT Rise Time	OUT Fall Time	Reverse Current Flow Blocking at Switch OFF	Package		Orderable Part Number
1000µs	3µs	-	SOP8	Reel of 2500	BD6520F-E2
1000µs	4µs	○	SOP8	Reel of 2500	BD6522F-E2

Block Diagrams

(BD6520F)

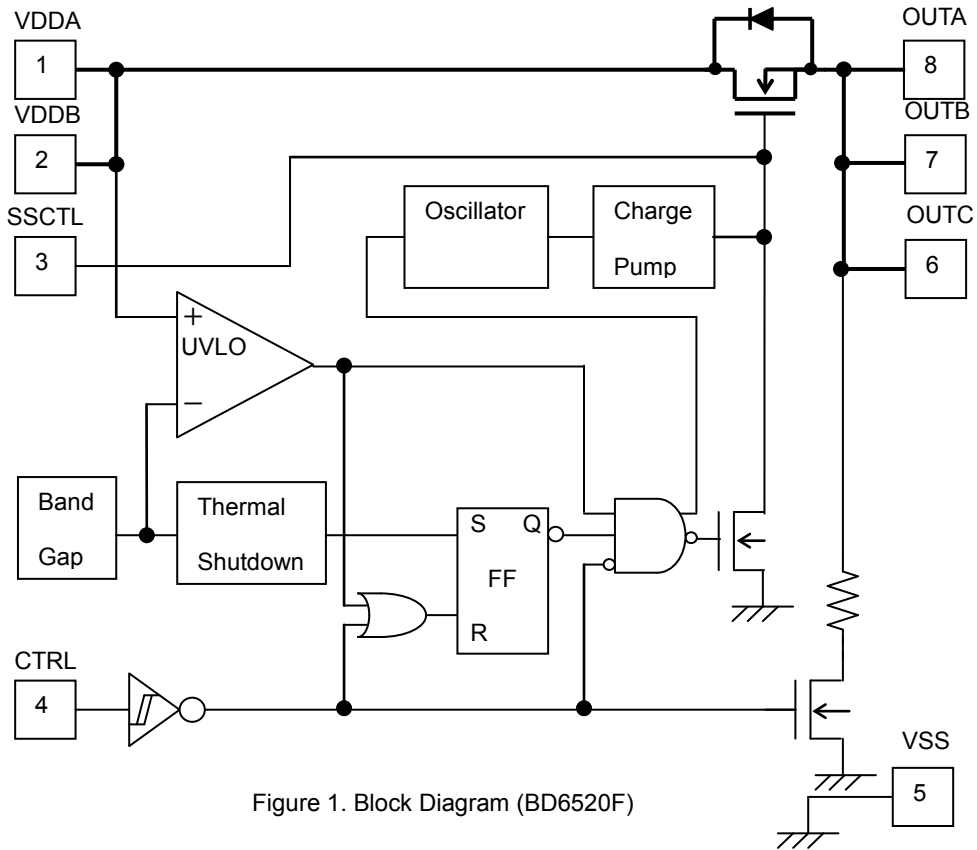

Figure 1. Block Diagram (BD6520F)

(BD6522F)

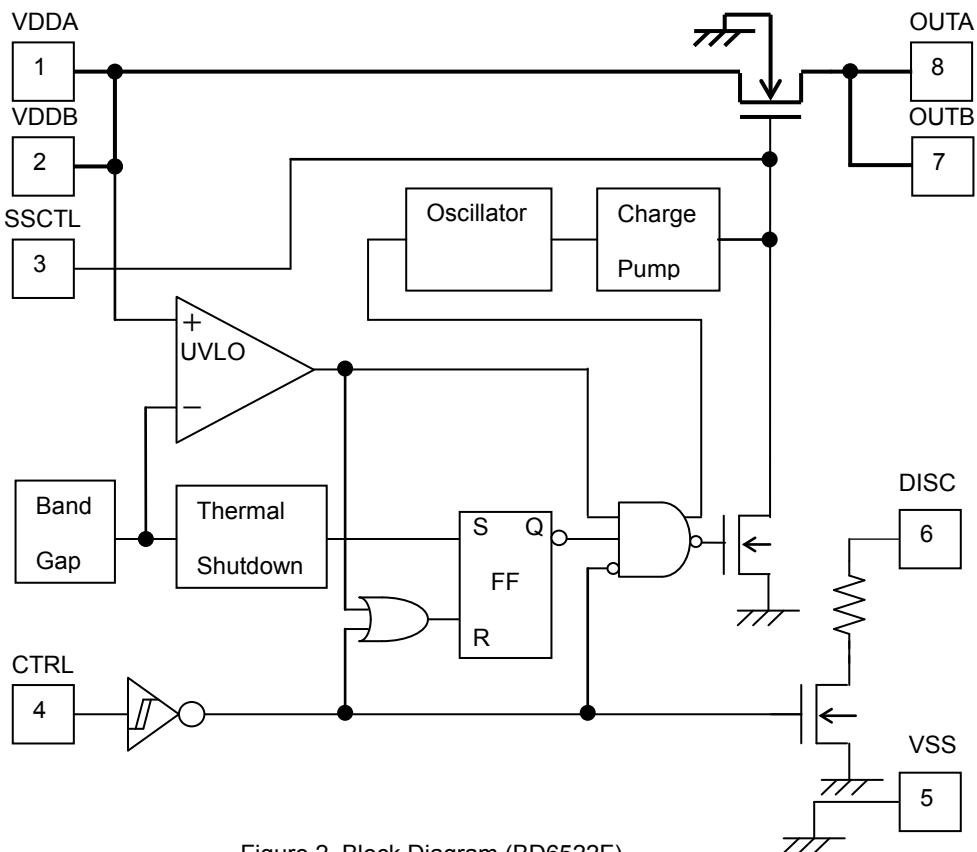
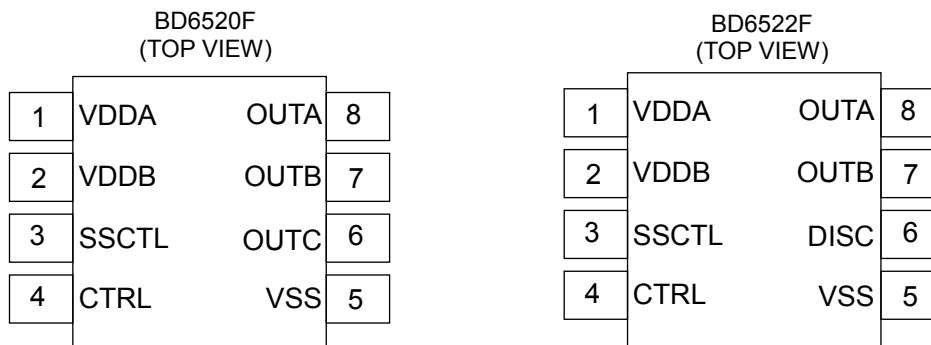

Figure 2. Block Diagram (BD6522F)

Pin Configurations



Pin Descriptions

BD6520F

Pin No.	Symbol	Pin Function
1,2	VDDA, VDDDB	Switch input pin When in use, connect each pin externally.
3	SSCTL	Soft start setting pin Adding an external capacitor makes it possible to delay switching (ON or OFF) time.
4	CTRL	Control input pin Switch on at high level, switch OFF at low level.
5	VSS	Ground
6,7,8	OUTA, OUTB, OUTC	Switch output pin When in use, connect each pin externally.

BD6522F

Pin No.	Symbol	Pin Function
1,2	VDDA, VDDDB	Switch input pin When in use, connect each pin externally.
3	SSCTL	Soft start setting pin Adding an external capacitor makes it possible to delay switching (ON or OFF) time.
4	CTRL	Control input pin Switch ON at high level, switch OFF at low level.
5	VSS	Ground
6	DISC	Discharge pin
7,8	OUTA, OUTB	Switch output pin When in use, connect each pin externally.

Absolute Maximum Ratings

Parameter	Symbol	Rating	Unit
Supply Voltage	V_{DD}	-0.3 to +6.0	V
CTRL Input Voltage	V_{CTRL}	-0.3 to +6.0	V
Switch Output Voltage	V_{OUT}	-0.3 to $V_{DD} + 0.3$ (BD6520F)	V
		-0.3 to +6.0 (BD6522F)	V
Storage Temperature	Tstg	-55 to +150	°C
Power Dissipation	Pd	0.69 (Note 1)	W

(Note 1) Mounted on 70mm x 70mm x 1.6mm glass-epoxy PCB. Derating : 5.5mW/°C above $T_a=25^\circ\text{C}$.

Caution: Operating the IC over the absolute maximum ratings may damage the IC. The damage can either be a short circuit between pins or an open circuit between pins and the internal circuitry. Therefore, it is important to consider circuit protection measures, such as adding a fuse, in case the IC is operated over the absolute maximum ratings.

Recommended Operating Conditions

Parameter	Symbol	Rating			Unit
		Min	Typ	Max	
Supply Voltage	V_{DD}	3.0	-	5.5	V
Switch Current	I_{OUT}	0	-	2	A
Operating Temperature	Topr	-25	-	+85	°C

Electrical Characteristics

BD6520F (Unless otherwise specified, $T_a=25^\circ\text{C}$, $V_{DD}=5\text{V}$)

Parameter	Symbol	Limit			Unit	Conditions
		Min	Typ	Max		
ON-Resistance	R_{ON1}	-	50	70	mΩ	$V_{DD}=5\text{V}$, $V_{CTRL}=5\text{V}$
	R_{ON2}	-	60	85	mΩ	$V_{DD}=3\text{V}$, $V_{CTRL}=3\text{V}$
Operating Current	I_{DD}	-	110	220	μA	$V_{CTRL}=5\text{V}$, OUT= OPEN
	I_{DDST}	-	-	2	μA	$V_{CTRL}=0\text{V}$, OUT= OPEN
Control Input Voltage	V_{CTRLH}	-	-	0.7	V	V_{CTRLH} = High Level
	V_{CTRLH}	2.5	-	-	V	V_{CTRLH} = High Level
Control Input Current	I_{CTRL}	-1	0	+1	μA	V_{CTRL} = L, H
Turn ON Delay	t_{rd}	200	1000	2000	μs	$R_L=10\Omega$, SSCTL = OPEN CTRL= L→H → OUT=50%
Turn ON Rise Time	t_r	500	2000	7500	μs	$R_L=10\Omega$, SSCTL = OPEN OUT= 10% to 90%
Turn OFF Delay	t_{fd}	-	3	20	μs	$R_L=10\Omega$, SSCTL = OPEN CTRL= H→L → OUT=50%
Turn OFF Fall Time	t_f	-	1	20	μs	$R_L=10\Omega$, SSCTL = OPEN OUT= 90% to 10%
Discharge Resistance	R_{SWDC}	-	350	600	Ω	$V_{DD}=5\text{V}$, $V_{CTRL}=0\text{V}$, $V_{OUT}=5\text{V}$
UVLO Threshold Voltage	V_{UVLOH}	2.3	2.5	2.7	V	V_{DD} Increasing
	V_{UVLOL}	2.1	2.3	2.5	V	V_{DD} Decreasing
UVLO Hysteresis Voltage	V_{HYS}	100	200	300	mV	$V_{HYS} = V_{UVLOH} - V_{UVLOL}$
Thermal Shutdown Threshold	T_{TS}	-	135	-	°C	$V_{CTRL}=5\text{V}$
SSCTL Output Voltage	V_{SSCTL}	-	13.5	-	V	$V_{CTRL}=5\text{V}$

Electrical Characteristics - continued

BD6522F (Unless otherwise specified, Ta= 25°C, V_{DD}= 5V)

Parameter	Symbol	Limit			Unit	Conditions
		Min	Typ	Max		
ON-Resistance	R _{ON1}	-	50	70	mΩ	V _{DD} = 5V, V _{CTRL} = 5V
	R _{ON2}	-	60	85	mΩ	V _{DD} = 3.3V, V _{CTRL} = 3.3V
Operating Current	I _{DD}	-	110	220	μA	V _{CTRL} = 5V, OUT= OPEN
	I _{DDST}	-	-	2	μA	V _{CTRL} = 0V, OUT= OPEN
Control Input Voltage	V _{CTRLH}	2.5	-	-	V	V _{CTRLH} = High Level
	V _{CTRLH}	-	-	0.7	V	V _{CTRLH} = Low Level
Control Input Current	I _{CTRL}	-1	0	+1	μA	V _{CTRL} = L, H
Turn ON Time	t _{ON}	-	1000	3500	μs	R _L = 10Ω, SSCTL= OPEN CTRL= H → OUT= 90%
Turn OFF Time	t _{OFF}	-	4	20	μs	R _L = 10Ω, SSCTL= OPEN CTRL= L → OUT= 10%
Discharge Resistance	R _{SWDC}	-	350	600	Ω	V _{DD} = 5V, V _{CTRL} = 0V
UVLO Threshold Voltage	V _{UVLOH}	2.3	2.5	2.7	V	V _{DD} Increasing
	V _{UVLOL}	2.1	2.3	2.5	V	V _{DD} Decreasing
UVLO Hysteresis Voltage	V _{HYS}	100	200	300	mV	V _{HYS} = V _{UVLOH} - V _{UVLOL}
Thermal Shutdown Threshold	T _{TS}	-	135	-	°C	V _{CTRL} = 5V
SSCTL Output Voltage	V _{SSCTL}	-	13.5	-	V	V _{CTRL} = 5V

Measurement Circuit

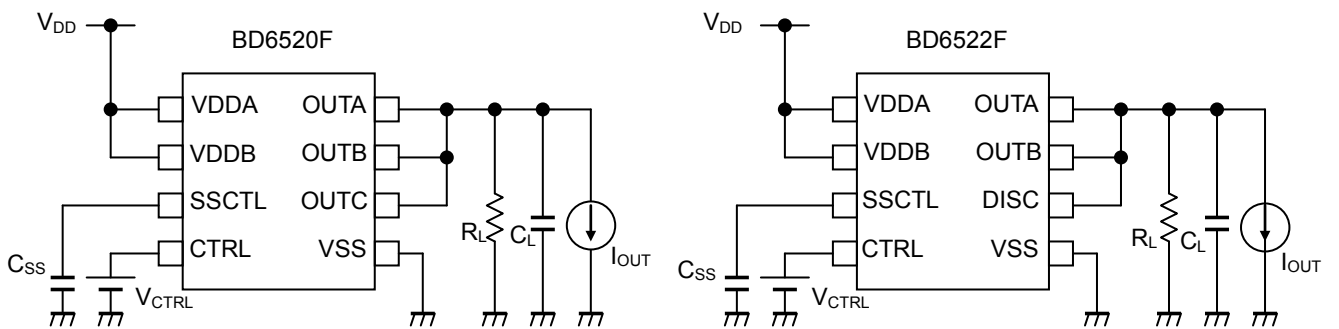

Figure 3. Measurement Circuit

Timing Diagram

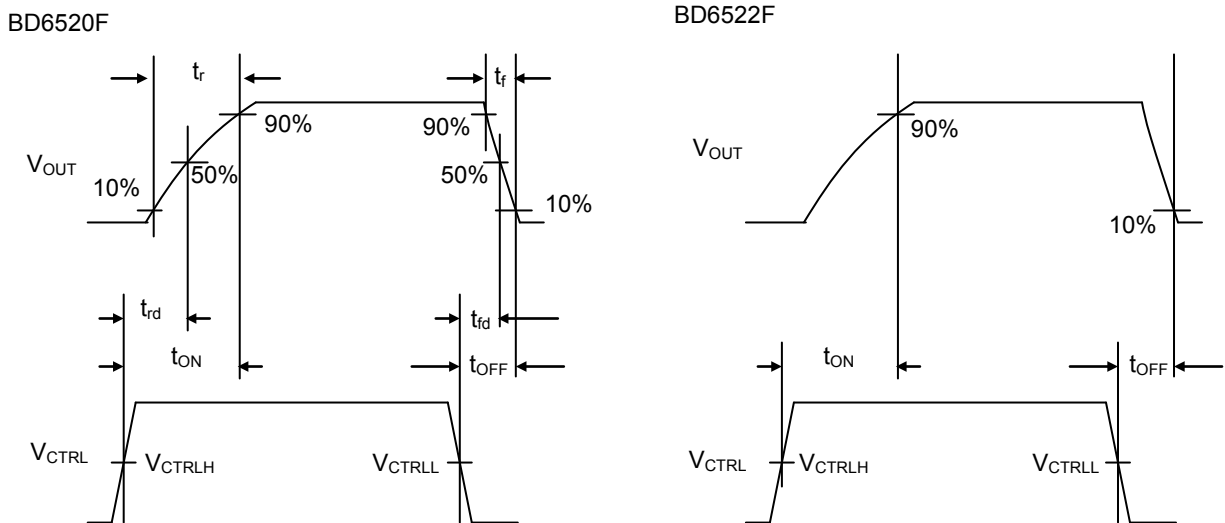

Figure 4. Timing Diagram

Typical Performance Curves

BD6520F

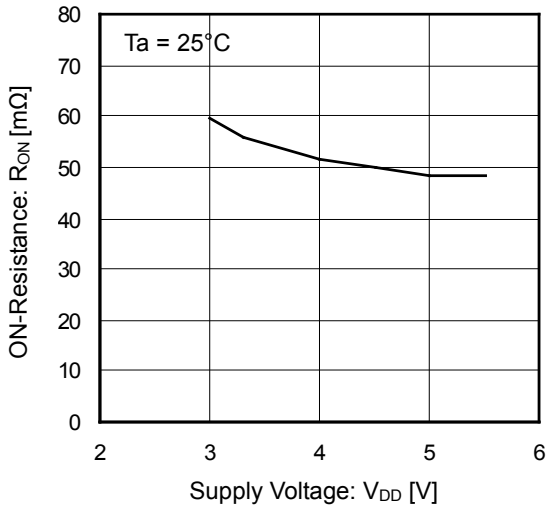

Figure 5. ON-Resistance vs Supply Voltage

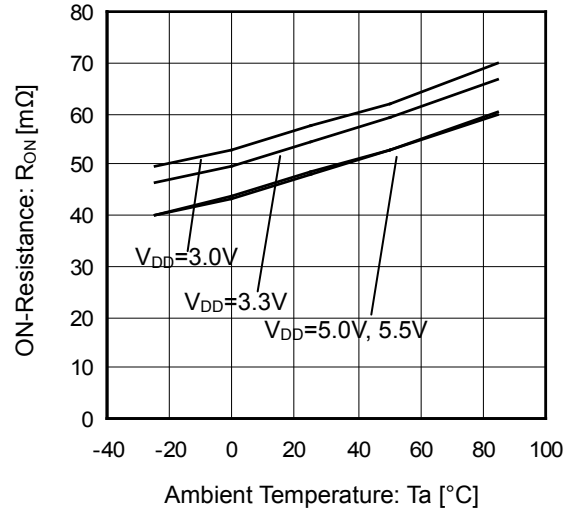

Figure 6. ON-Resistance vs Ambient Temperature

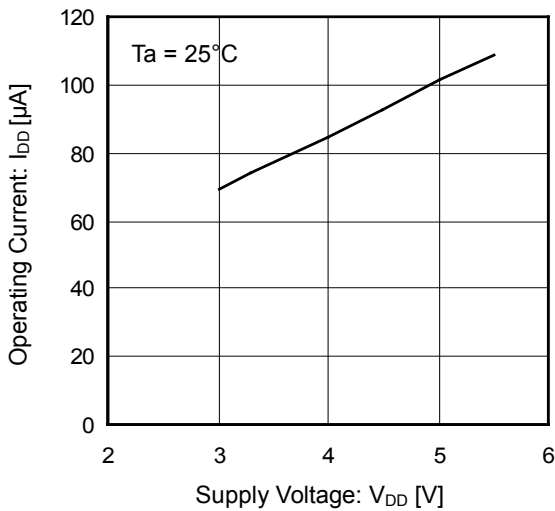

Figure 7. Operating Current vs Supply Voltage (CTRL Enable)

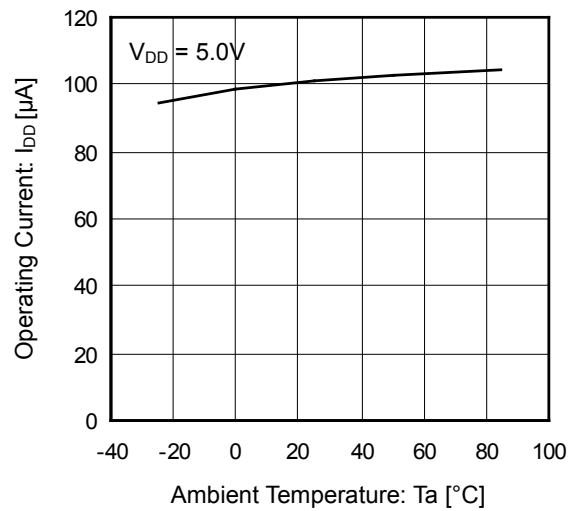

Figure 8. Operating Current vs Ambient Temperature (CTRL Enable)

Typical Performance Curves - continued

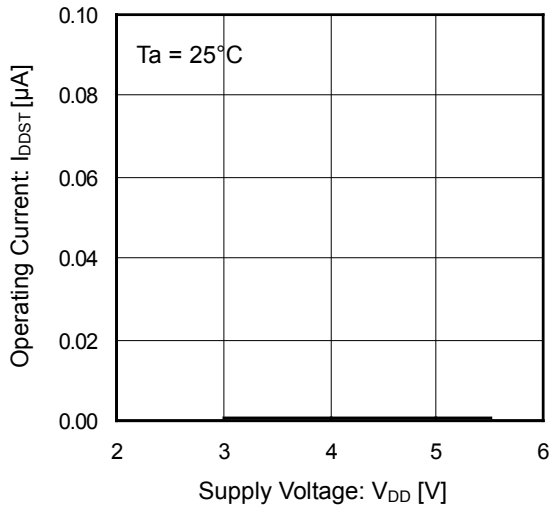

Figure 9. Operating Current vs Supply Voltage (CTRL Disable)

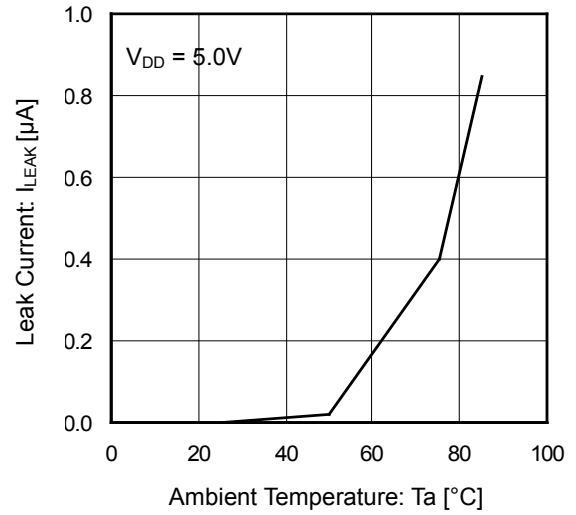

Figure 10. Leak Current vs Ambient Temperature

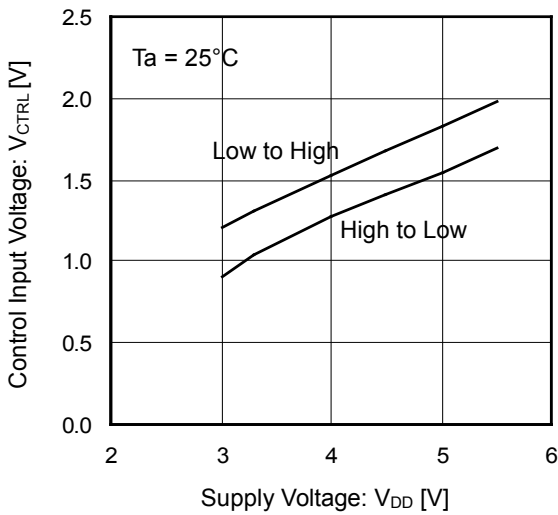

Figure 11. Control Input Voltage vs Supply Voltage

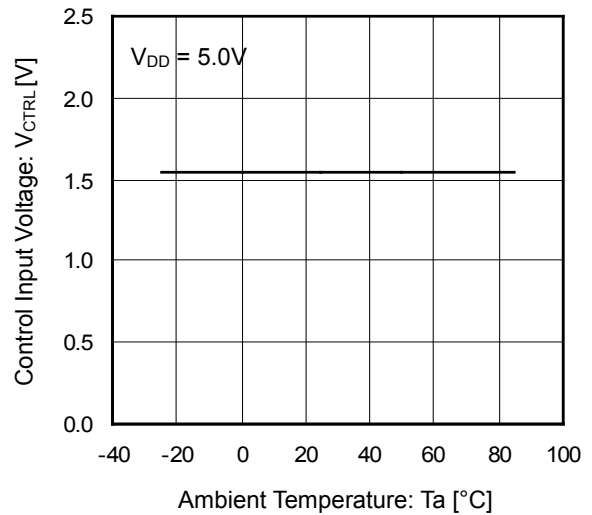

Figure 12. Control Input Voltage vs Ambient Temperature (H to L)

Typical Performance Curves - continued

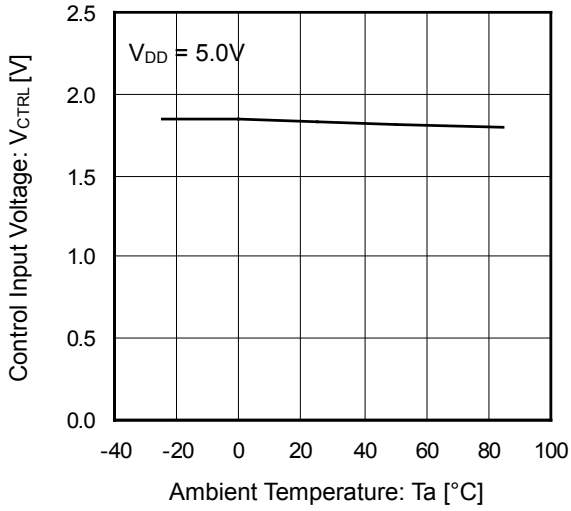

Figure 13. Control Input Voltage vs Ambient Temperature (L to H)

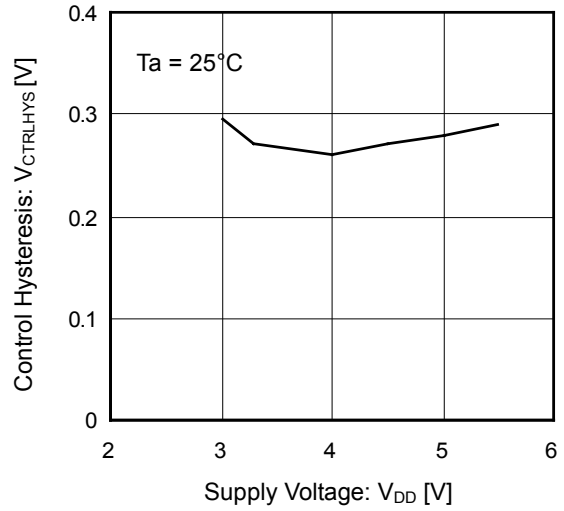

Figure 14. Control Hysteresis Voltage vs Supply Voltage

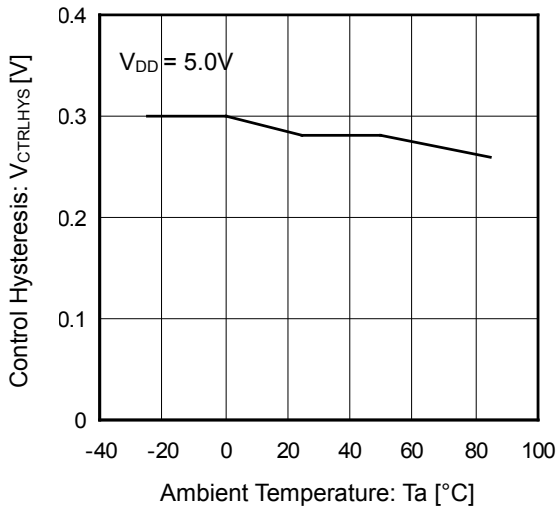

Figure 15. Control Hysteresis Voltage vs Ambient Temperature

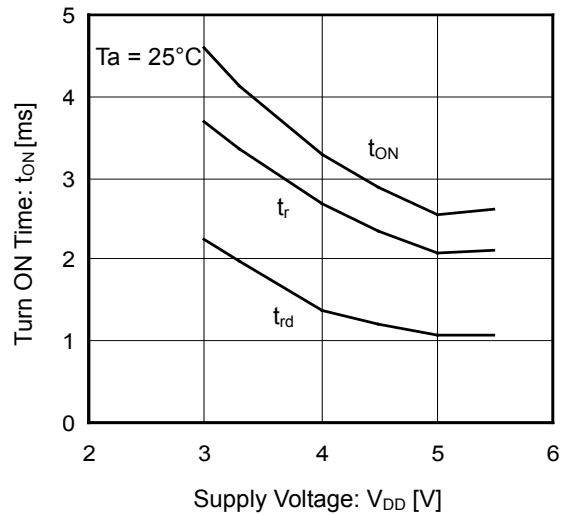

Figure 16. Turn ON Time vs Supply Voltage

Typical Performance Curves - continued

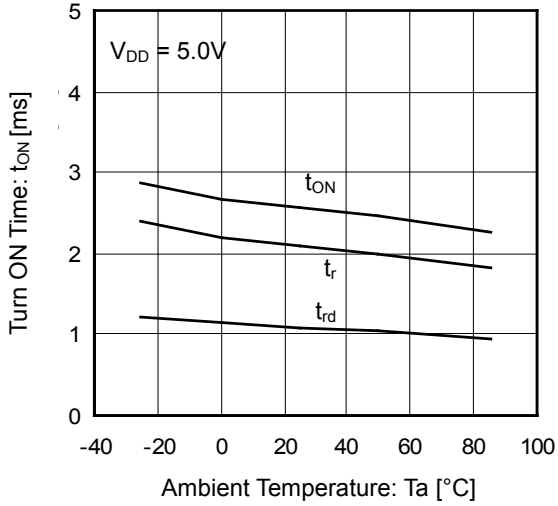

Figure 17. Turn ON Time vs Ambient Temperature

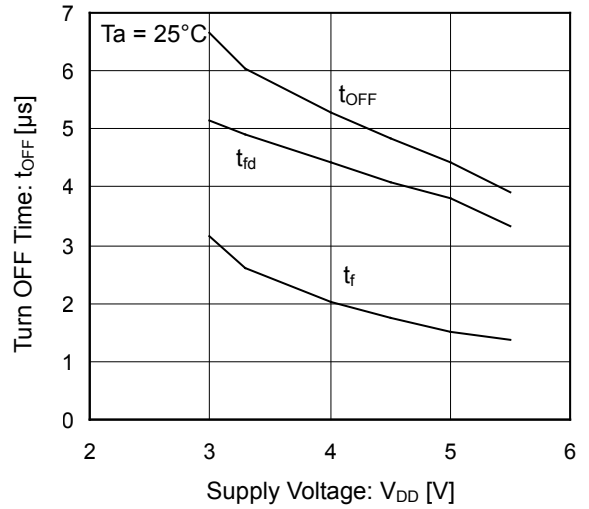

Figure 18. Turn OFF Time vs Supply Voltage

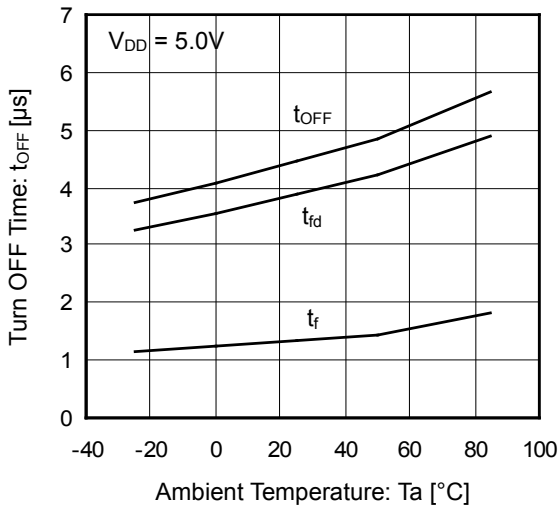

Figure 19. Turn OFF Time vs Ambient Temperature

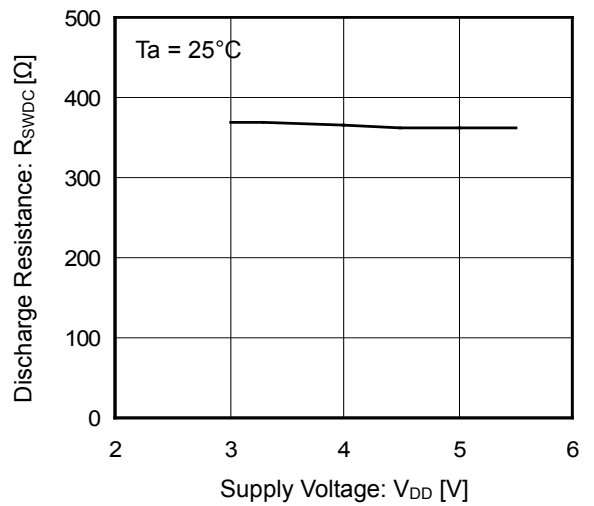

Figure 20. Discharge Resistance vs Supply Voltage

Typical Performance Curves - continued

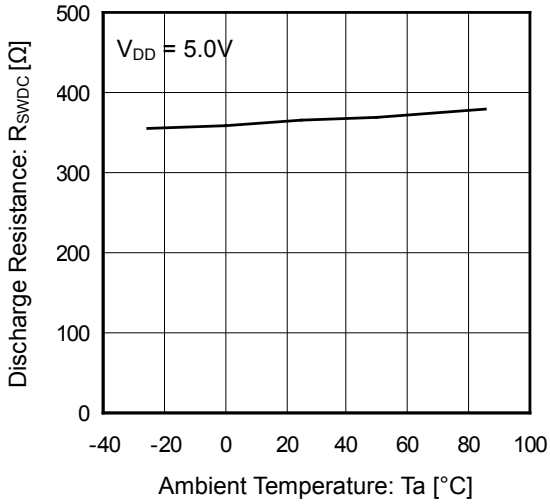

Figure 21. Discharge Resistance vs Ambient Temperature

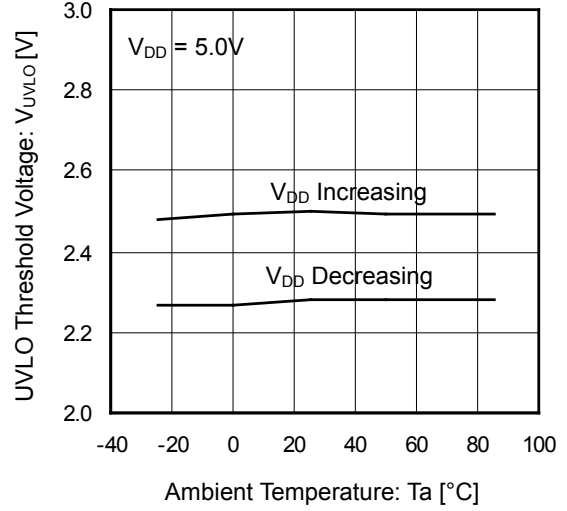

Figure 22. UVLO Threshold Voltage vs Ambient Temperature

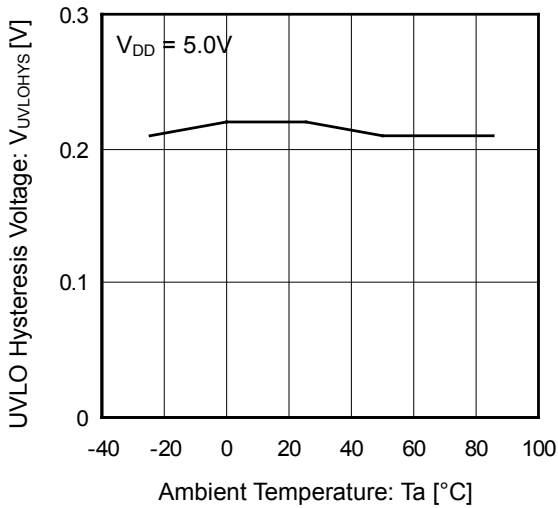

Figure 23. UVLO Hysteresis Voltage vs Ambient Temperature

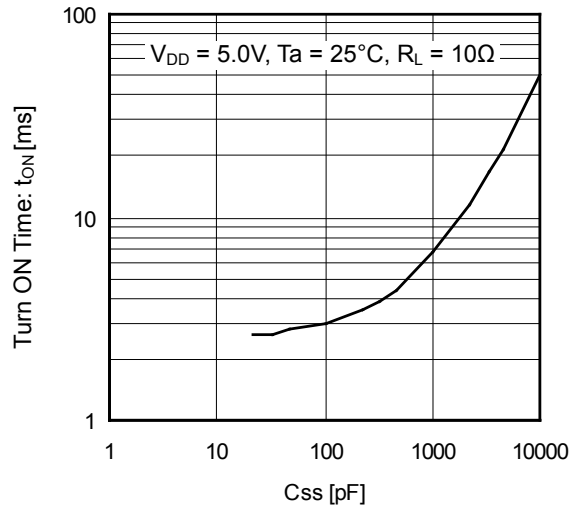

Figure 24. Turn ON Time vs C_{SS}

Typical Performance Curves - continued

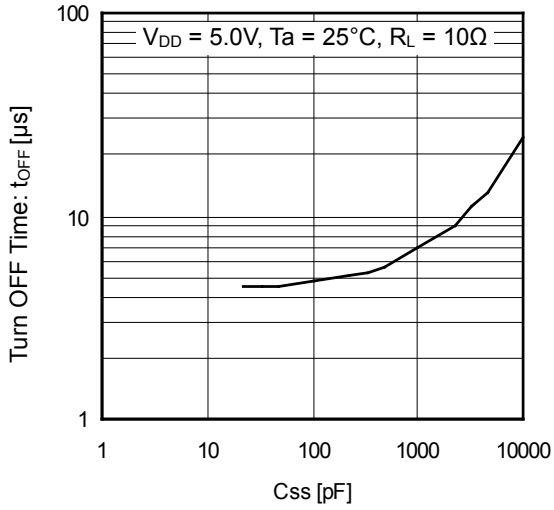

Figure 25. Turn OFF Time vs C_{ss}

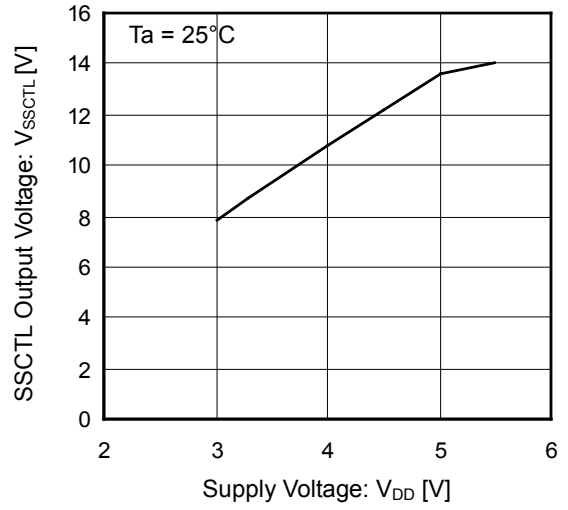

Figure 26. SSCTL Output Voltage vs Supply Voltage

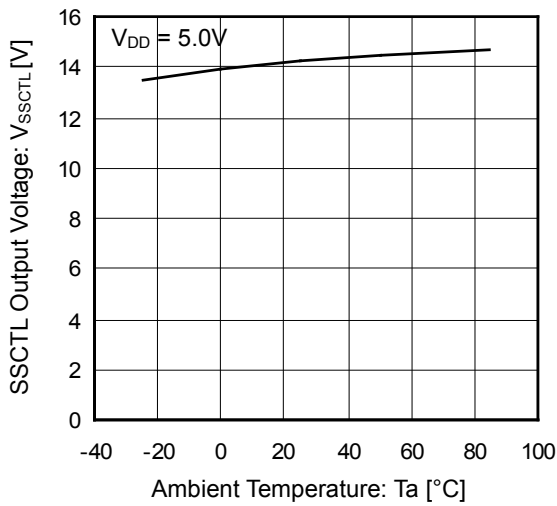

Figure 27. SSCTL Output Voltage vs Ambient Temperature

Typical Performance Curves - continued

BD6522F

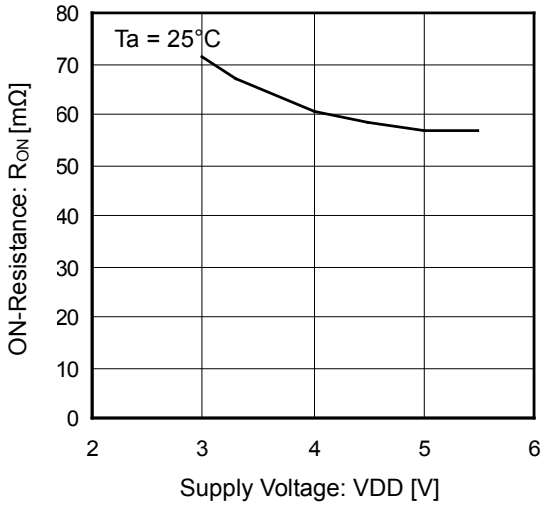

Figure 28. ON-Resistance vs Supply Voltage

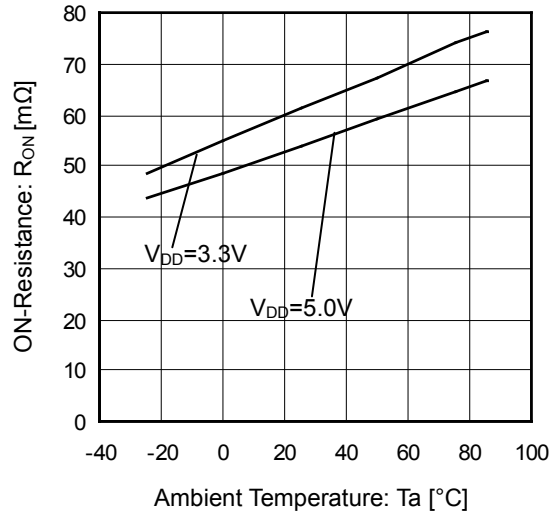

Figure 29. ON-Resistance vs Ambient Temperature

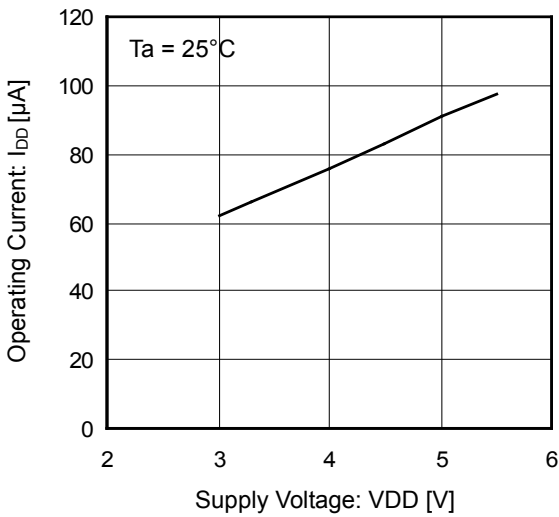

Figure 30. Operating Current vs Supply Current (CTRL Enable)

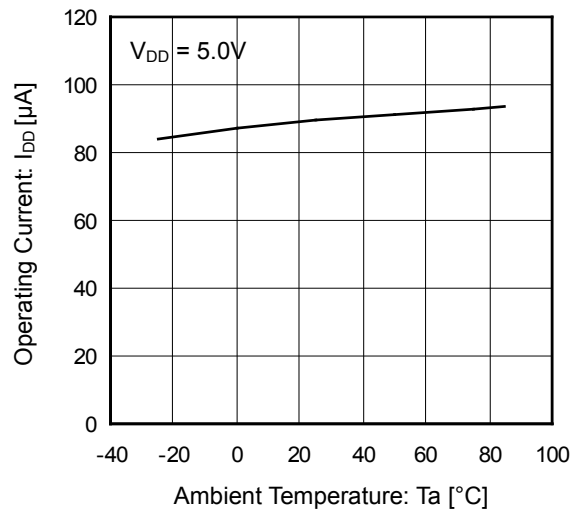

Figure 31. Operating Current vs Ambient Temperature (CTRL Enable)

Typical Performance Curves - continued

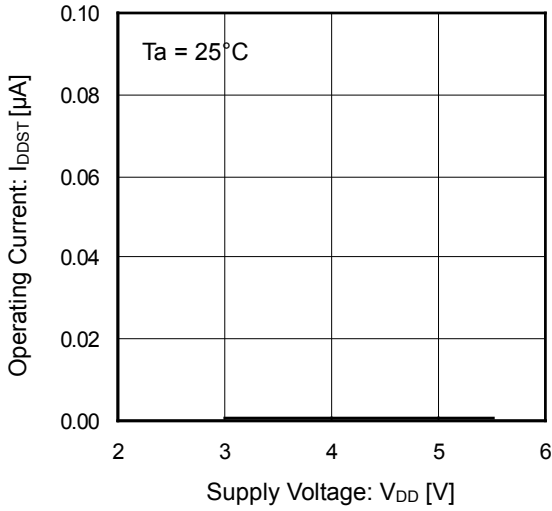

Figure 32. Operating Current vs Supply Voltage (CTRL Disable)

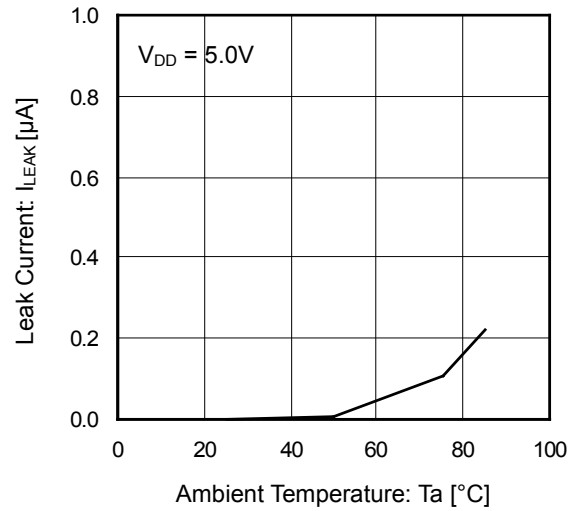

Figure 33. Leak Current vs Ambient Temperature

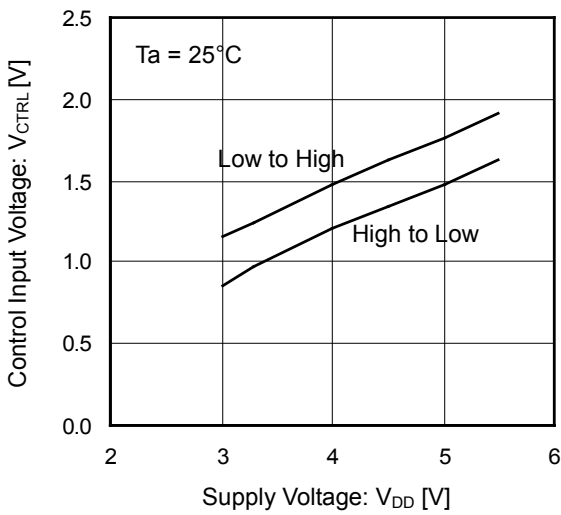

Figure 34. Control Input Voltage vs Supply Voltage

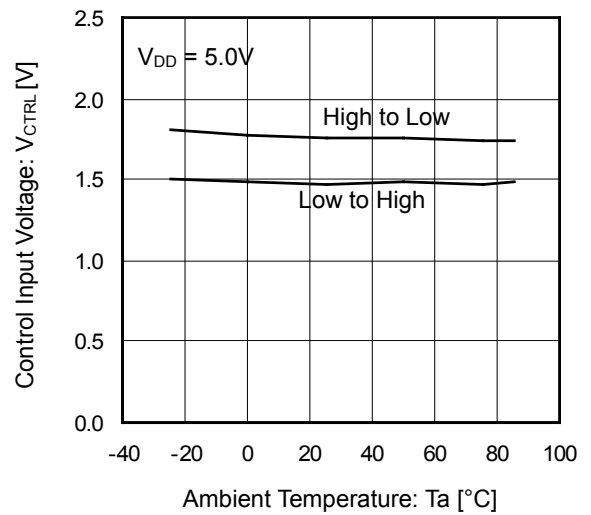

Figure 35. Control Input Voltage vs Ambient Temperature

Typical Performance Curves - continued

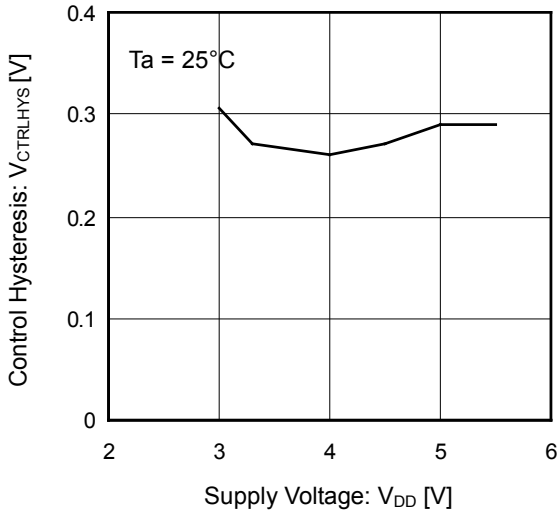

Figure 36. Control Hysteresis Voltage vs Supply Voltage

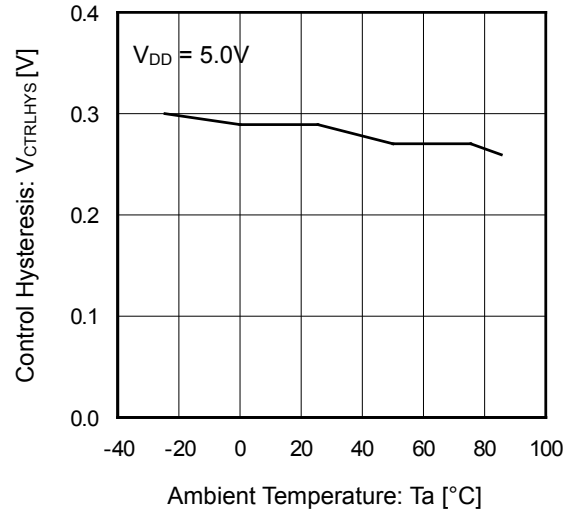

Figure 37. Control Hysteresis Voltage vs Ambient Temperature

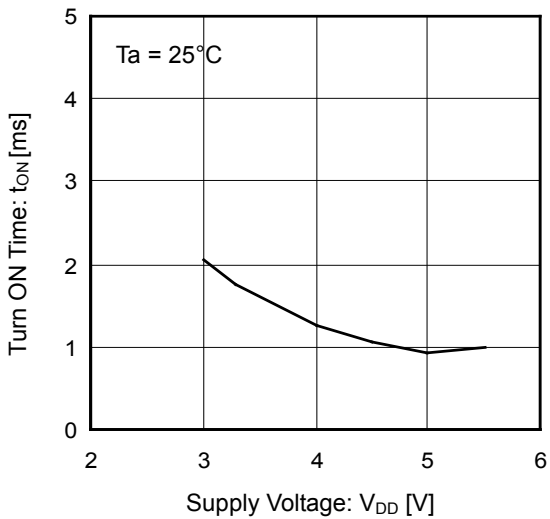

Figure 38. Turn ON Time vs Supply Voltage

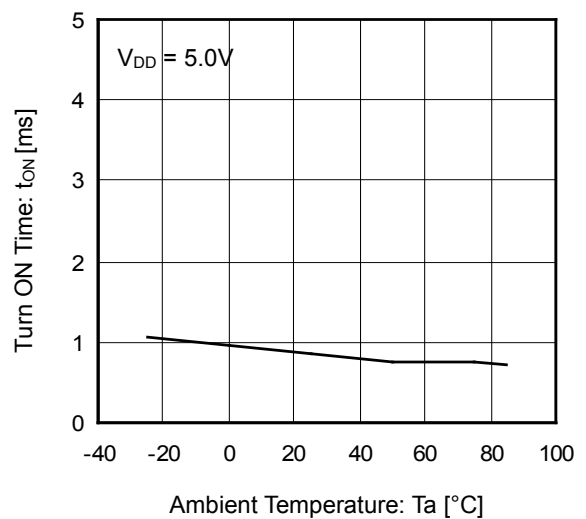

Figure 39. Turn ON Time vs Ambient Temperature

Typical Performance Curves - continued

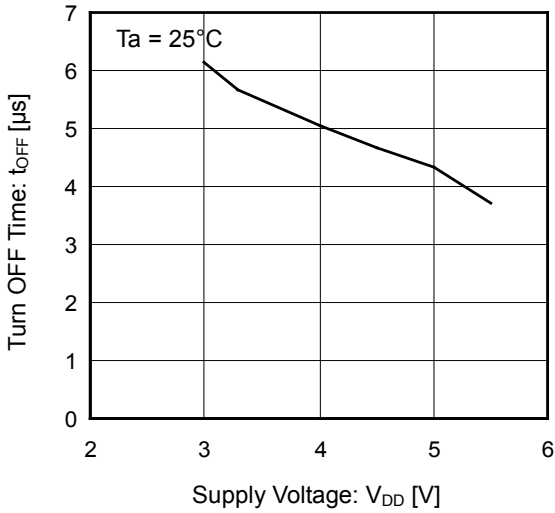

Figure 40. Turn OFF Time vs Supply Voltage

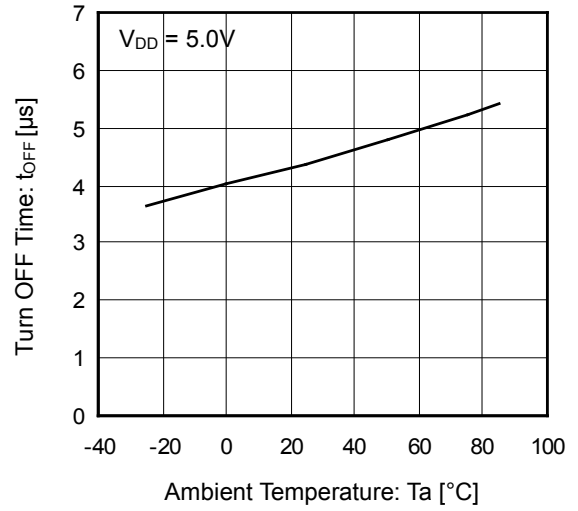

Figure 41. Turn OFF Time vs Ambient Temperature

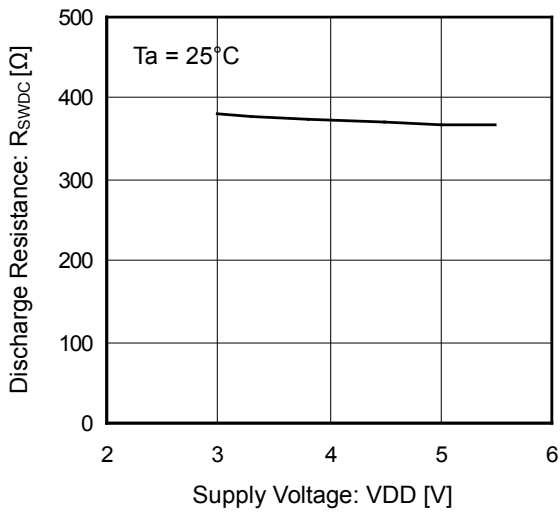

Figure 42. Discharge Resistance vs Supply Voltage

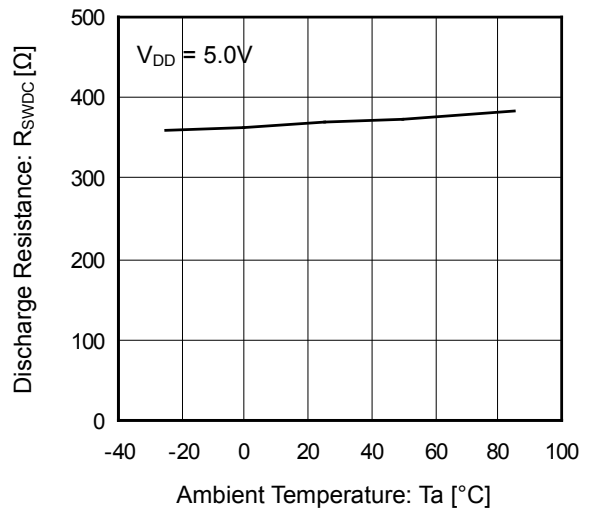

Figure 43. Discharge Resistance vs Ambient Temperature

Typical Performance Curves - continued

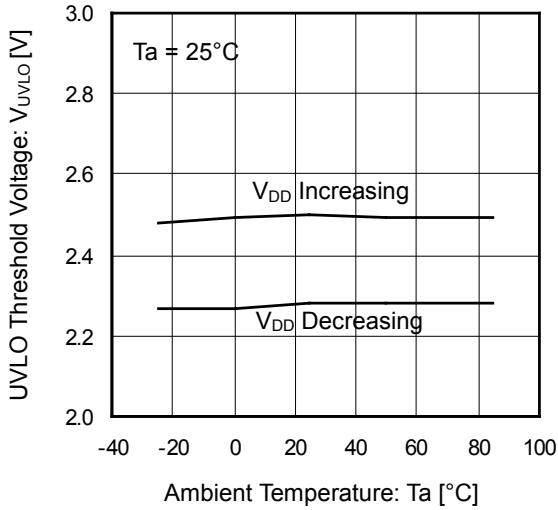

Figure 44. UVLO Threshold Voltage vs Ambient Temperature

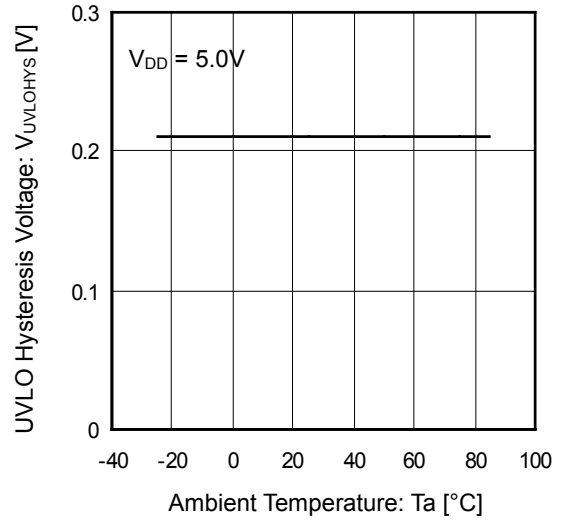

Figure 45. UVLO Hysteresis Voltage vs Ambient Temperature

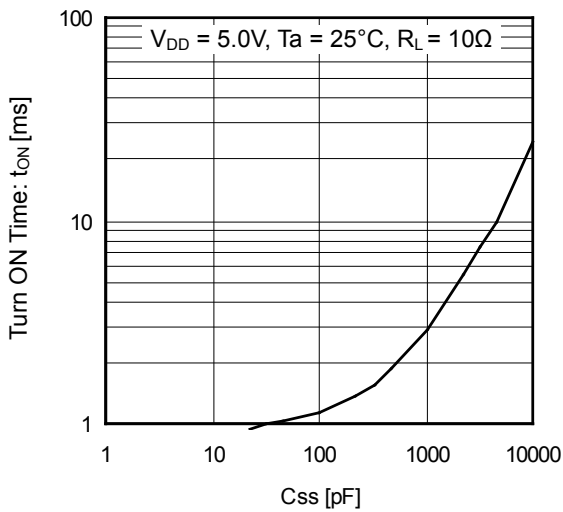

Figure 46. Turn ON Time vs C_{SS}

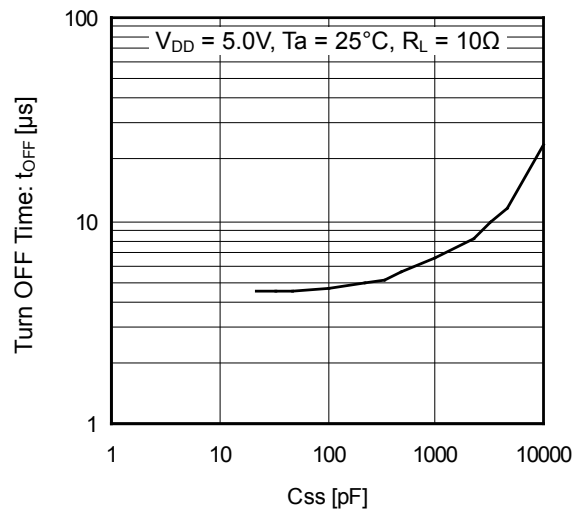

Figure 47. Turn OFF Time vs C_{SS}

Typical Performance Curves - continued

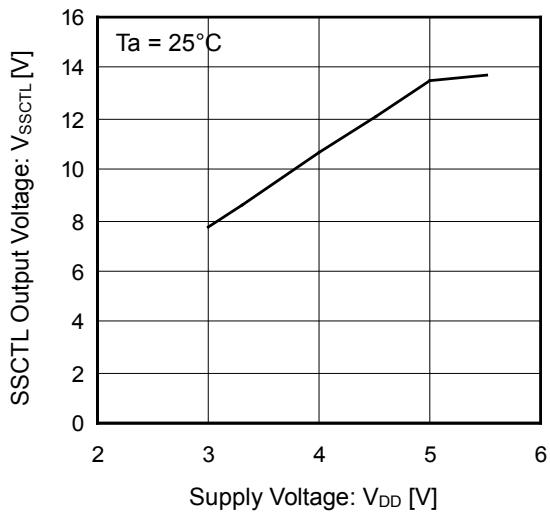

Figure 48. SSCTL Output Voltage vs Supply Voltage

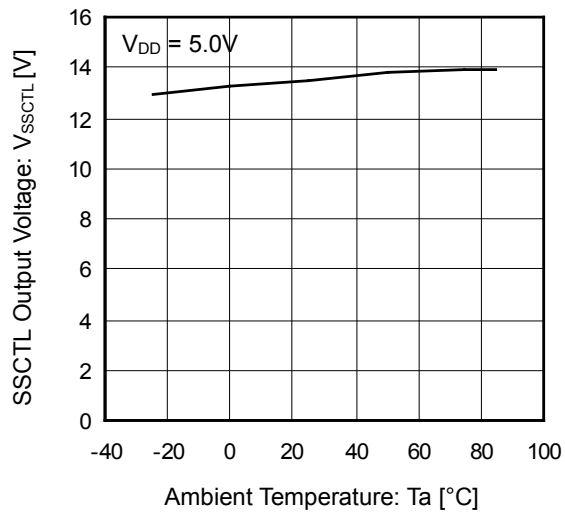

Figure 49. SSCTL Output Voltage vs Ambient Temperature

Typical Wave Forms

$V_{DD} = 5V$, $C_L = 47\mu F$, $R_L = 47\Omega$, unless otherwise specified.

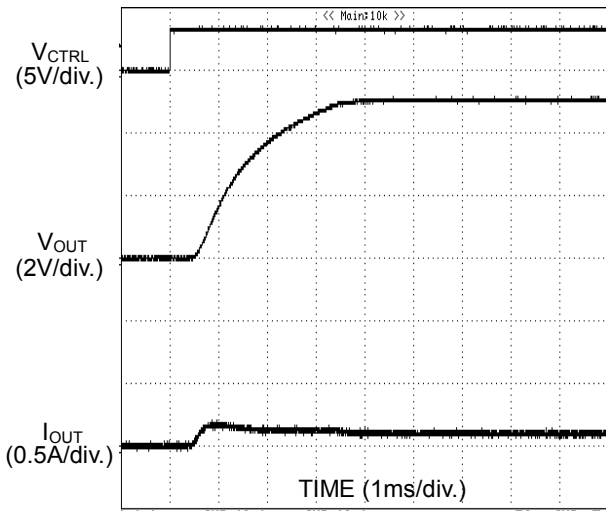

Figure 50. Turn ON Rise Time (BD6520F)

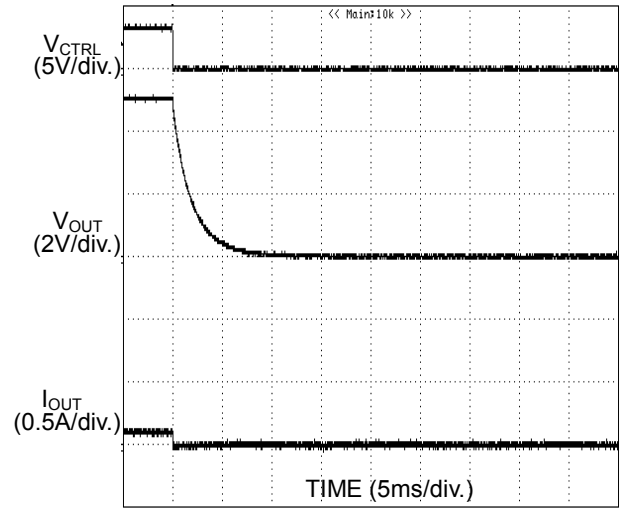

Figure 51. Turn OFF Fall Time (BD6520F)

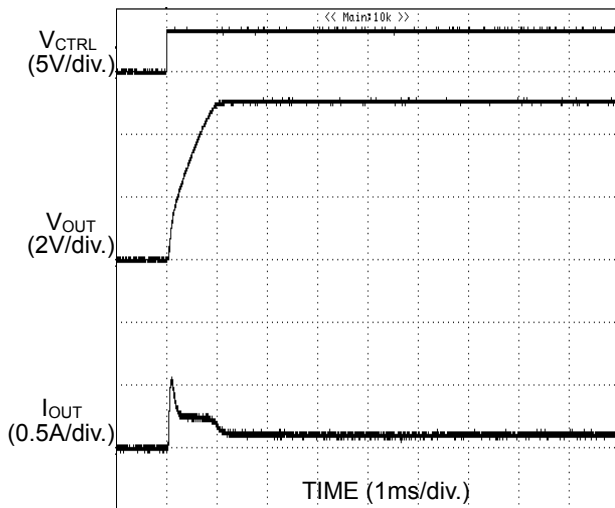

Figure 52. Turn ON Rise Time (BD6522F)

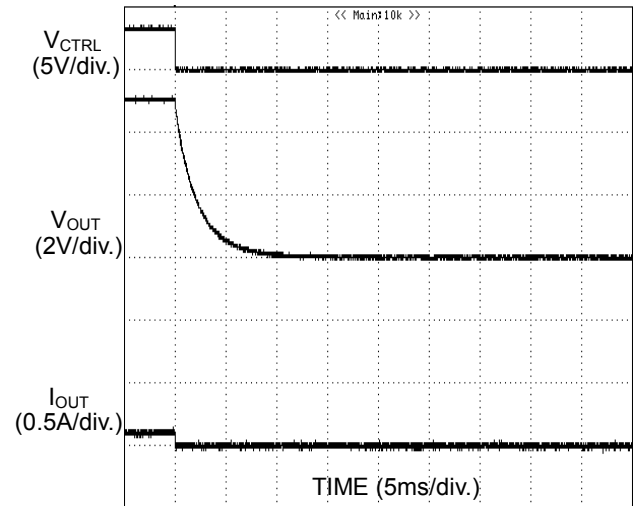

Figure 53. Turn OFF Fall Time (BD6522F)

Typical Wave Forms - continued

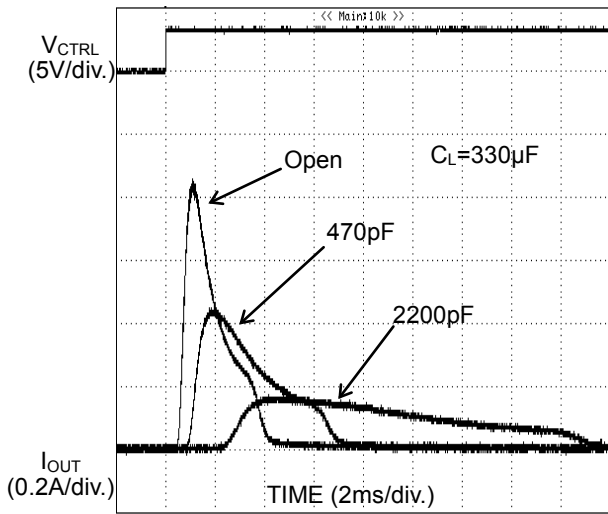

Figure 54. Inrush Current vs Ccss (BD6520F)

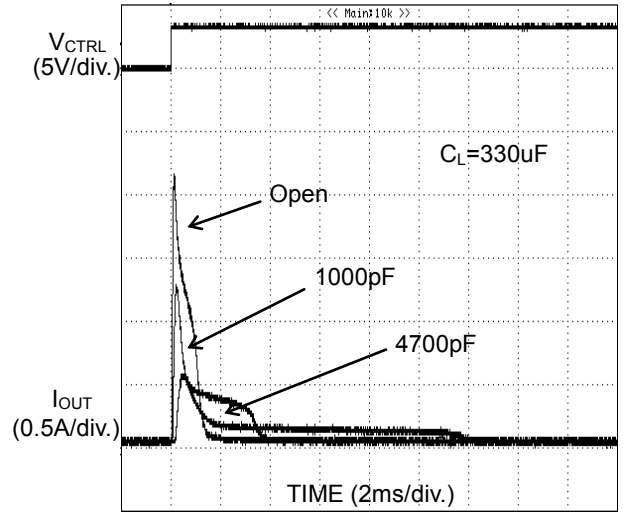

Figure 55. Inrush Current vs Ccss (BD6522F)

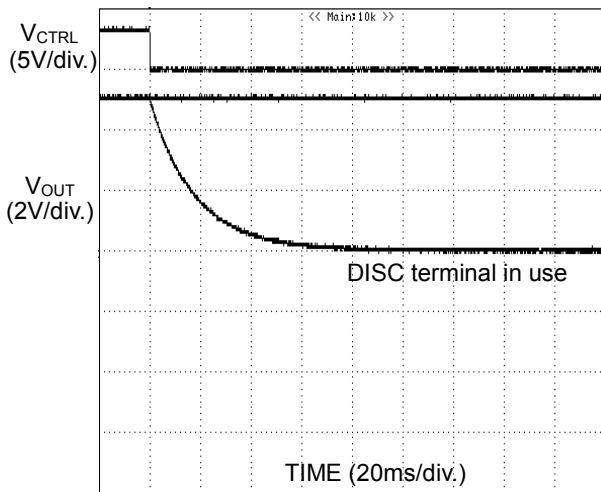

Figure 56. Discharge: CL = 47µF, RL = Open (BD6522F)

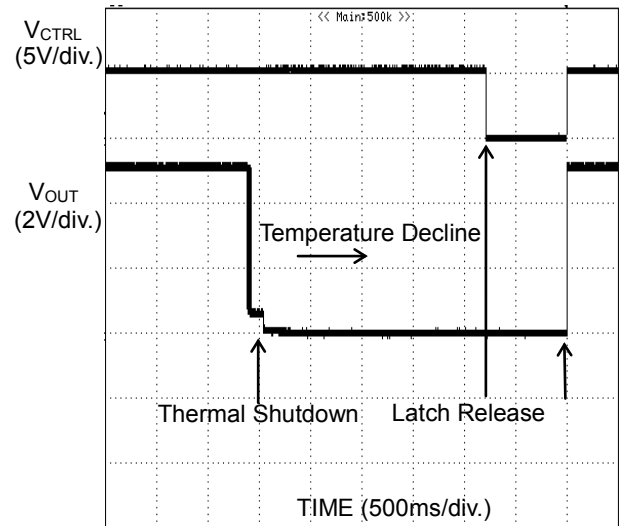

Figure 57. Thermal Shutdown

Typical Wave Forms - continued

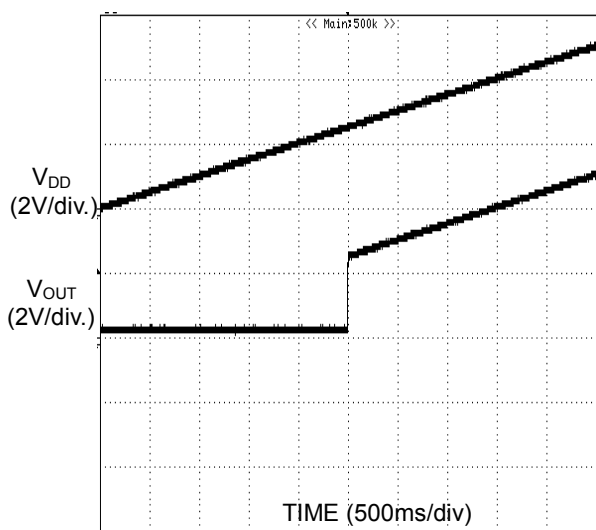

Figure 58. UVLO
(at V_{DD} Increase)

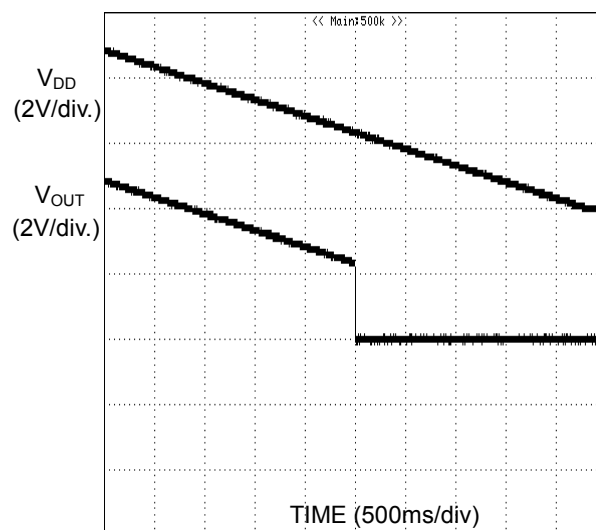

Figure 59. UVLO
(at V_{DD} Decrease)

Typical Application Circuits

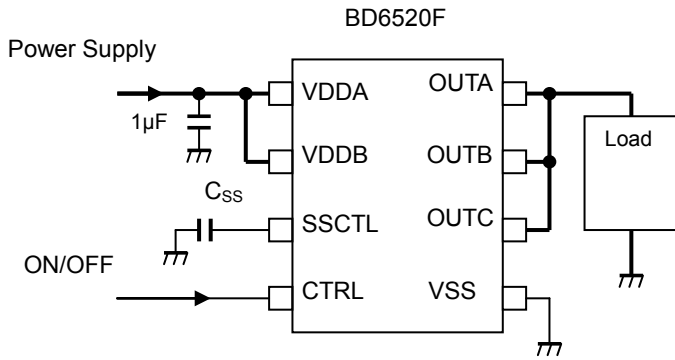

Figure 60. Power Supply Switch Circuit (BD6520F)

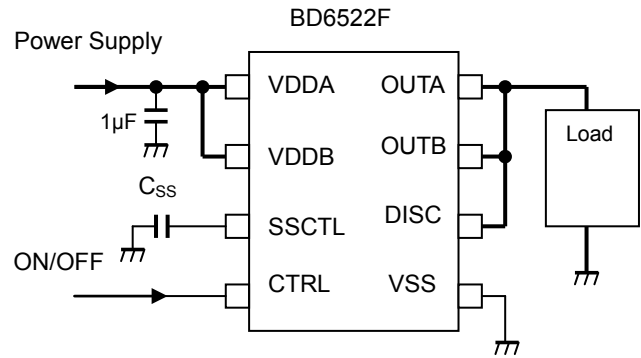

Figure 61. Power Supply Switch Circuit (BD6522F)

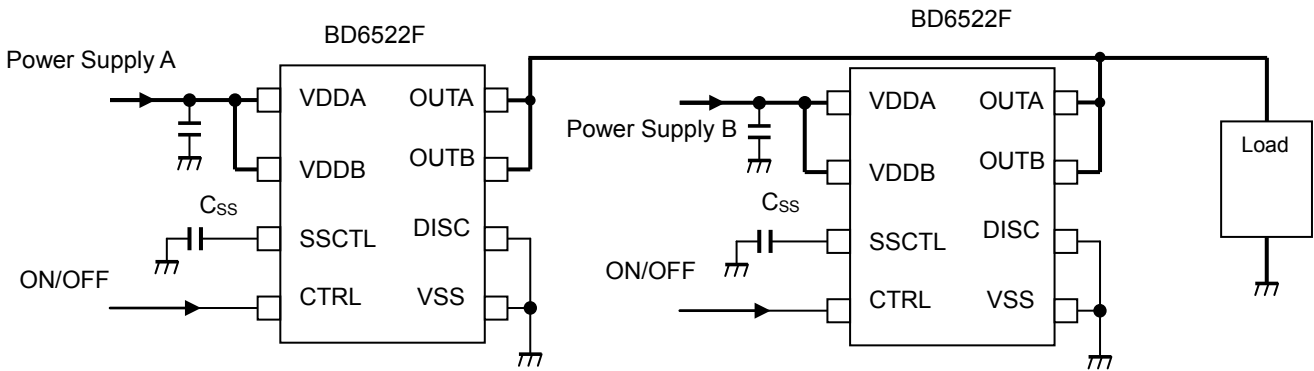

Figure 62. 2 Power Supply Changeover Switch Circuit (BD6522F)

Application Information

1. Functional Description

(1) Switch Operation

VDD pin and OUT pin are connected to the drain and source of the Power MOSFET (switch) respectively. VDD also serves as the power source input to the internal control circuit.

When CTRL input is set to high and the switch is turned ON, VDD and OUT are connected by a 50mΩ resistance. Normally, current flows from VDD to OUT. But since the switch is bidirectional, if the voltage of OUT is higher than that of VDD, current flows from OUT to VDD.

In BD6520F, there is a parasitic diode between the drain and the source of switch. Therefore, when the switch is OFF and the voltage of OUT is higher than that of VDD, current will flow from OUT to VDD. In BD6522F, there is no parasitic diode, thus, current flow from OUT to VDD is prevented.

(2) Thermal Shutdown

The thermal shut down circuit turns OFF the switch when the junction temperature exceeds 135°C (Typ). However, the CTRL signal should be active for thermal shutdown to work.

The switch OFF status of the thermal shut down is latched. Therefore, even when the junction temperature goes down, OFF status is maintained. There are two ways to release the latch, first is by toggling the CTRL pin from H to L to H. Second, is by resetting the power supply V_{DD}.

(3) Under Voltage Lockout (UVLO)

The UVLO circuit compares the VDD voltage with the UVLO threshold (2.5V rising, 2.3V falling, Typ) to ensure that V_{DD} is high enough for reliable operation. The 200mV (Typ) hysteresis prevents supply transients from causing a shutdown. Once V_{DD} exceeds the UVLO rising threshold, start-up begins. When V_{DD} falls below the UVLO falling threshold, the circuit turns OFF the switch. However, the CTRL input should be active for UVLO to work.

(4) Soft Start Control

BD6520F/BD6522F has a soft start control to reduce inrush current at switch ON.

By connecting an external capacitor between SSCTL and GND, switch rise time can be smoothed. When the switch is enabled, SSCTL outputs a voltage of about 13.5V. The SSCTL terminal requires high impedance, therefore, proper packaging should be observed to avoid leak current. When a certain value of voltage is supplied to SSCTL, switching is disabled.

(5) Discharge Circuit

When the switch between VDD and OUT is OFF, the 350Ω (Typ) discharge switch resistance between OUT and GND turns on. By turning ON this switch, the electric current stored by the capacitive load is discharged.

In BD6522F, the input of the discharge circuit (DISC) is separated from the OUT pin. When the discharge circuit is used, simply connect OUT and DISC to ensure proper operation.

Timing Diagram

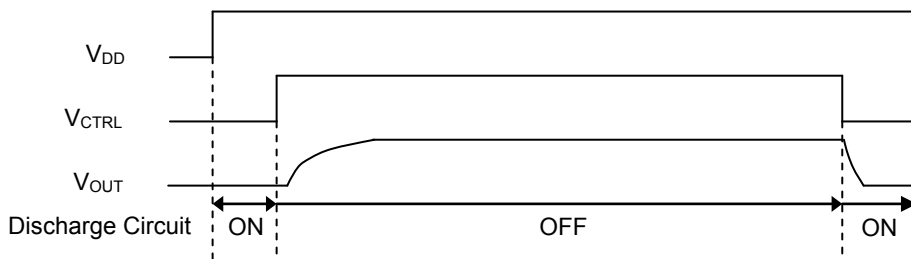

Figure 63. Normal Operation

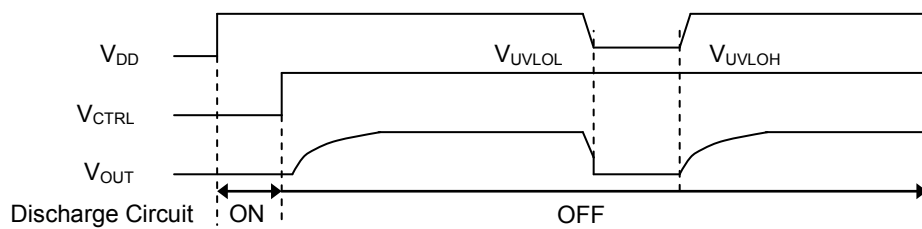

Figure 64. UVLO Operation

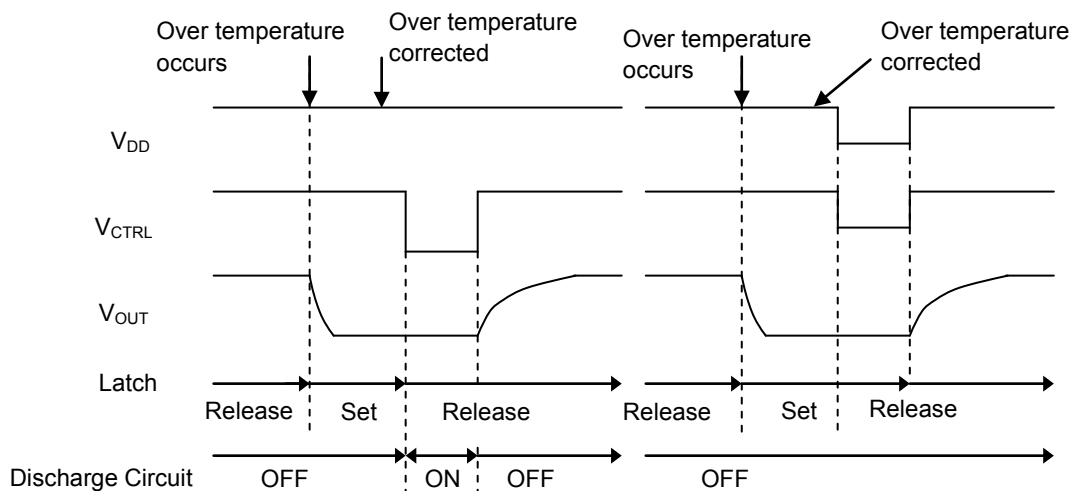
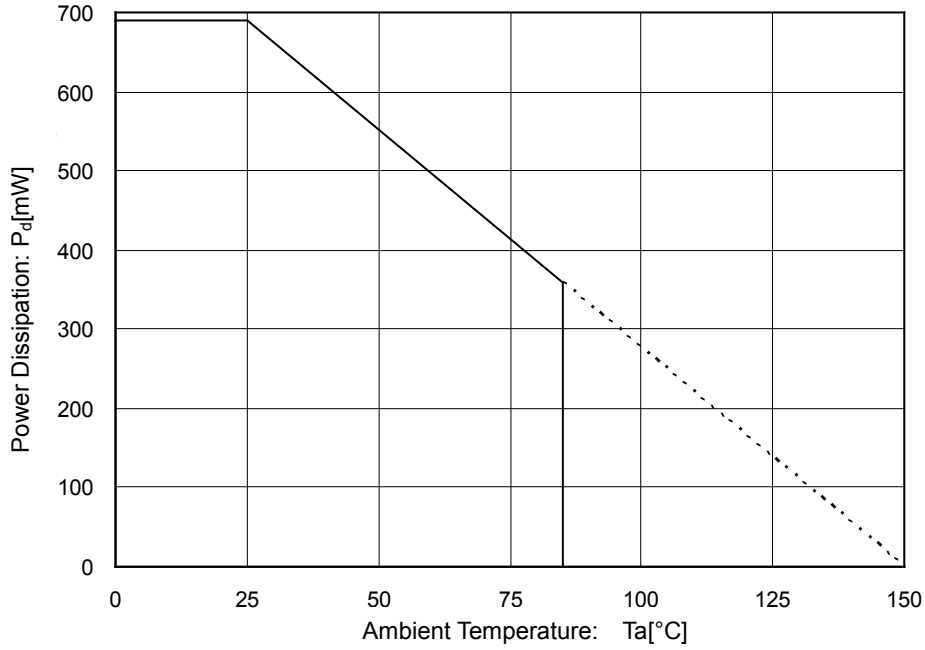

Figure 65. Thermal Shutdown Operation

Power Dissipation

(SOP8)



70mm x 70mm x 1.6mm Glass Epoxy Board

Figure 66. Power Dissipation Curve (Pd-Ta Curve)

I/O Equivalence Circuit

Symbol	Pin No.	Equivalence Circuit BD6520F	Equivalence Circuit BD6522F
SSCTL	3		
CTRL	4		
DISC	6 (BD6522F)	—	
OUT	6 (BD6520F), 7, 8		

Operational Notes**1. Reverse Connection of Power Supply**

Connecting the power supply in reverse polarity can damage the IC. Take precautions against reverse polarity when connecting the power supply, such as mounting an external diode between the power supply and the IC's power supply pins.

2. Power Supply Lines

Design the PCB layout pattern to provide low impedance supply lines. Separate the ground and supply lines of the digital and analog blocks to prevent noise in the ground and supply lines of the digital block from affecting the analog block. Furthermore, connect a capacitor to ground at all power supply pins. Consider the effect of temperature and aging on the capacitance value when using electrolytic capacitors.

3. Ground Voltage

Ensure that no pins are at a voltage below that of the ground pin at any time, even during transient condition.

4. Ground Wiring Pattern

When using both small-signal and large-current ground traces, the two ground traces should be routed separately but connected to a single ground at the reference point of the application board to avoid fluctuations in the small-signal ground caused by large currents. Also ensure that the ground traces of external components do not cause variations on the ground voltage. The ground lines must be as short and thick as possible to reduce line impedance.

5. Thermal Consideration

Should by any chance the power dissipation rating be exceeded the rise in temperature of the chip may result in deterioration of the properties of the chip. The absolute maximum rating of the Pd stated in this specification is when the IC is mounted on a 70mm x 70mm x 1.6mm glass epoxy board. In case of exceeding this absolute maximum rating, increase the board size and copper area to prevent exceeding the Pd rating.

6. Recommended Operating Conditions

These conditions represent a range within which the expected characteristics of the IC can be approximately obtained. The electrical characteristics are guaranteed under the conditions of each parameter.

7. Inrush Current

When power is first supplied to the IC, it is possible that the internal logic may be unstable and inrush current may flow instantaneously due to the internal powering sequence and delays, especially if the IC has more than one power supply. Therefore, give special consideration to power coupling capacitance, power wiring, width of ground wiring, and routing of connections.

8. Operation Under Strong Electromagnetic Field

Operating the IC in the presence of a strong electromagnetic field may cause the IC to malfunction.

9. Testing on Application Boards

When testing the IC on an application board, connecting a capacitor directly to a low-impedance output pin may subject the IC to stress. Always discharge capacitors completely after each process or step. The IC's power supply should always be turned off completely before connecting or removing it from the test setup during the inspection process. To prevent damage from static discharge, ground the IC during assembly and use similar precautions during transport and storage.

10. Inter-pin Short and Mounting Errors

Ensure that the direction and position are correct when mounting the IC on the PCB. Incorrect mounting may result in damaging the IC. Avoid nearby pins being shorted to each other especially to ground, power supply and output pin. Inter-pin shorts could be due to many reasons such as metal particles, water droplets (in very humid environment) and unintentional solder bridge deposited in between pins during assembly to name a few.

Operational Notes - continued

11. Unused Input Pins

Input pins of an IC are often connected to the gate of a MOS transistor. The gate has extremely high impedance and extremely low capacitance. If left unconnected, the electric field from the outside can easily charge it. The small charge acquired in this way is enough to produce a significant effect on the conduction through the transistor and cause unexpected operation of the IC. So unless otherwise specified, unused input pins should be connected to the power supply or ground line.

12. Regarding the Input Pin of the IC

This monolithic IC contains P+ isolation and P substrate layers between adjacent elements in order to keep them isolated. P-N junctions are formed at the intersection of the P layers with the N layers of other elements, creating a parasitic diode or transistor. For example (refer to figure below):

When GND > Pin A and GND > Pin B, the P-N junction operates as a parasitic diode.
 When GND > Pin B, the P-N junction operates as a parasitic transistor.

Parasitic diodes inevitably occur in the structure of the IC. The operation of parasitic diodes can result in mutual interference among circuits, operational faults, or physical damage. Therefore, conditions that cause these diodes to operate, such as applying a voltage lower than the GND voltage to an input pin (and thus to the P substrate) should be avoided.

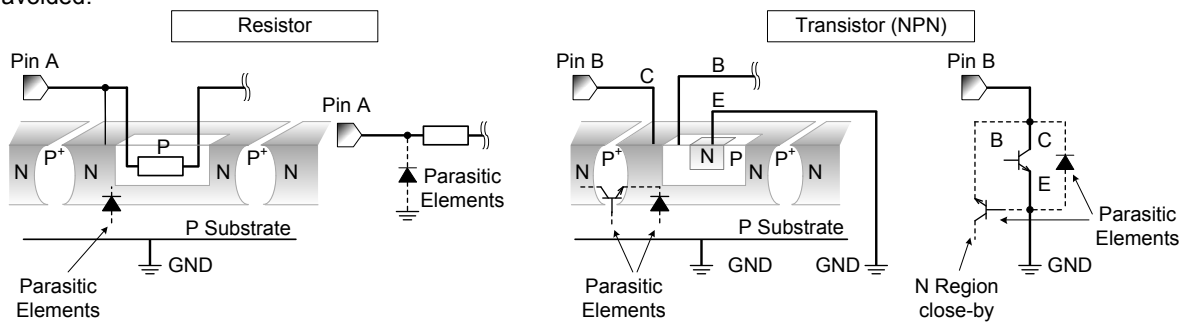

Figure 67. Example of monolithic IC structure

13. Ceramic Capacitor

When using a ceramic capacitor, determine the dielectric constant considering the change of capacitance with temperature and the decrease in nominal capacitance due to DC bias and others.

14. Thermal Shutdown Circuit(TSD)

This IC has a built-in thermal shutdown circuit that prevents heat damage to the IC. Normal operation should always be within the IC's power dissipation rating. If however the rating is exceeded for a continued period, the junction temperature (Tj) will rise which will activate the TSD circuit that will turn OFF all output pins. When the Tj falls below the TSD threshold, the circuits are automatically restored to normal operation.

Note that the TSD circuit operates in a situation that exceeds the absolute maximum ratings and therefore, under no circumstances, should the TSD circuit be used in a set design or for any purpose other than protecting the IC from heat damage.

Ordering Information

B D 6 5 2 0 F	-	E2
Part Number	Package F: SOP8	Packaging and forming specification E2: Embossed tape and reel
B D 6 5 2 2 F	-	E2
Part Number	Package F: SOP8	Packaging and forming specification E2: Embossed tape and reel

Marking Diagram

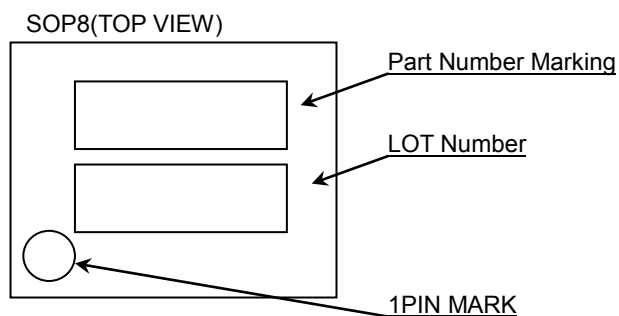

Part Number	Part Number Marking
BD6520F	D6520
BD6522F	D6522

Physical Dimension Tape and Reel Information

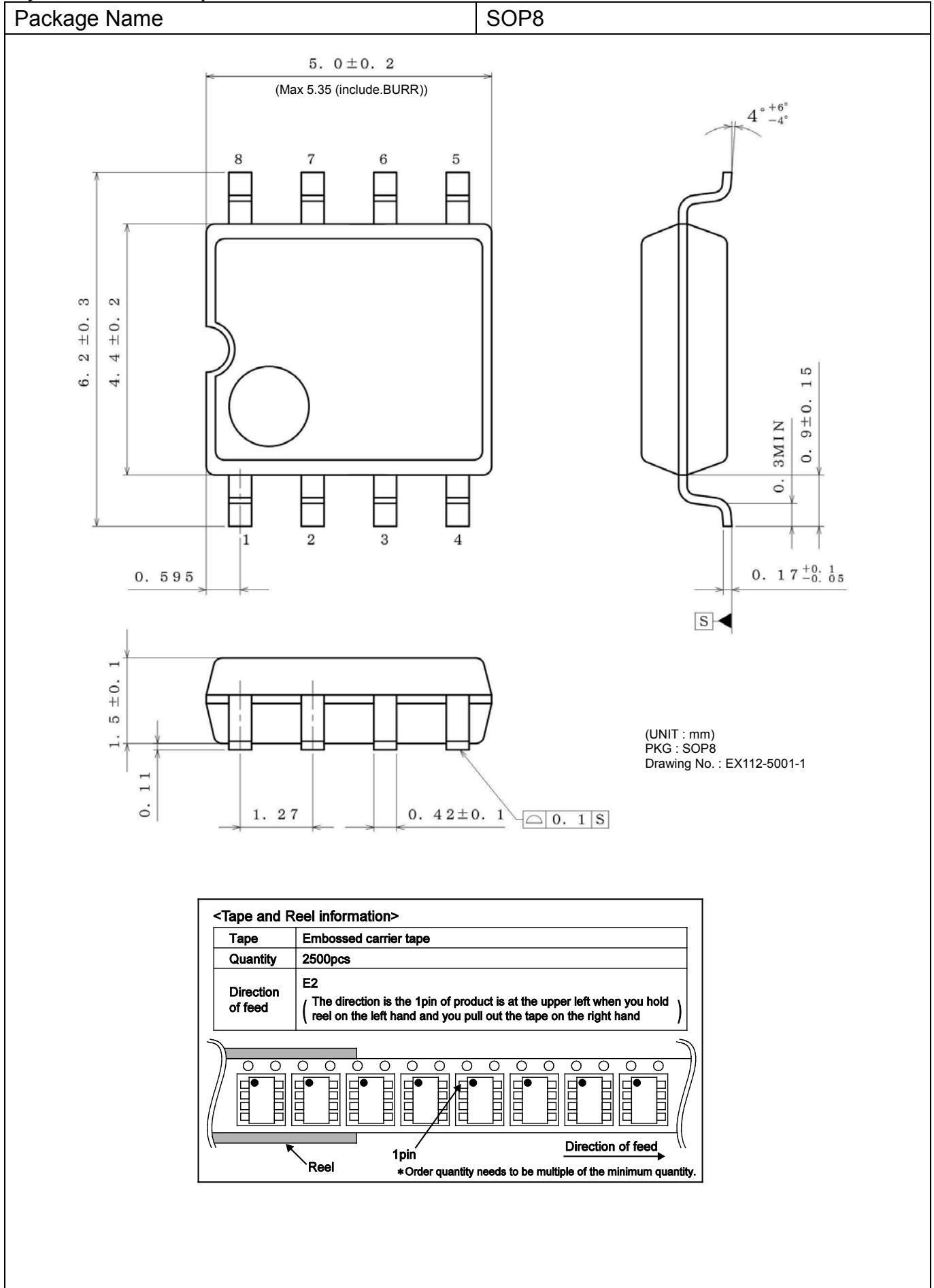

Revision History

Date	Revision	Changes
11.Mar.2013	001	New Release
21.Aug.2014	002	Applied the ROHM Standard Style and improved understandability.

Notice

Precaution on using ROHM Products

- Our Products are designed and manufactured for application in ordinary electronic equipments (such as AV equipment, OA equipment, telecommunication equipment, home electronic appliances, amusement equipment, etc.). If you intend to use our Products in devices requiring extremely high reliability (such as medical equipment ^(Note 1), transport equipment, traffic equipment, aircraft/spacecraft, nuclear power controllers, fuel controllers, car equipment including car accessories, safety devices, etc.) and whose malfunction or failure may cause loss of human life, bodily injury or serious damage to property ("Specific Applications"), please consult with the ROHM sales representative in advance. Unless otherwise agreed in writing by ROHM in advance, ROHM shall not be in any way responsible or liable for any damages, expenses or losses incurred by you or third parties arising from the use of any ROHM's Products for Specific Applications.

(Note1) Medical Equipment Classification of the Specific Applications

JAPAN	USA	EU	CHINA
CLASS III	CLASS III	CLASS II b	CLASS III
CLASS IV		CLASS III	

- ROHM designs and manufactures its Products subject to strict quality control system. However, semiconductor products can fail or malfunction at a certain rate. Please be sure to implement, at your own responsibilities, adequate safety measures including but not limited to fail-safe design against the physical injury, damage to any property, which a failure or malfunction of our Products may cause. The following are examples of safety measures:
 - Installation of protection circuits or other protective devices to improve system safety
 - Installation of redundant circuits to reduce the impact of single or multiple circuit failure
- Our Products are designed and manufactured for use under standard conditions and not under any special or extraordinary environments or conditions, as exemplified below. Accordingly, ROHM shall not be in any way responsible or liable for any damages, expenses or losses arising from the use of any ROHM's Products under any special or extraordinary environments or conditions. If you intend to use our Products under any special or extraordinary environments or conditions (as exemplified below), your independent verification and confirmation of product performance, reliability, etc. prior to use, must be necessary:
 - Use of our Products in any types of liquid, including water, oils, chemicals, and organic solvents
 - Use of our Products outdoors or in places where the Products are exposed to direct sunlight or dust
 - Use of our Products in places where the Products are exposed to sea wind or corrosive gases, including Cl₂, H₂S, NH₃, SO₂, and NO₂
 - Use of our Products in places where the Products are exposed to static electricity or electromagnetic waves
 - Use of our Products in proximity to heat-producing components, plastic cords, or other flammable items
 - Sealing or coating our Products with resin or other coating materials
 - Use of our Products without cleaning residue of flux (even if you use no-clean type fluxes, cleaning residue of flux is recommended); or Washing our Products by using water or water-soluble cleaning agents for cleaning residue after soldering
 - Use of the Products in places subject to dew condensation
- The Products are not subject to radiation-proof design.
- Please verify and confirm characteristics of the final or mounted products in using the Products.
- In particular, if a transient load (a large amount of load applied in a short period of time, such as pulse. is applied, confirmation of performance characteristics after on-board mounting is strongly recommended. Avoid applying power exceeding normal rated power; exceeding the power rating under steady-state loading condition may negatively affect product performance and reliability.
- De-rate Power Dissipation (Pd) depending on Ambient temperature (Ta). When used in sealed area, confirm the actual ambient temperature.
- Confirm that operation temperature is within the specified range described in the product specification.
- ROHM shall not be in any way responsible or liable for failure induced under deviant condition from what is defined in this document.

Precaution for Mounting / Circuit board design

- When a highly active halogenous (chlorine, bromine, etc.) flux is used, the residue of flux may negatively affect product performance and reliability.
- In principle, the reflow soldering method must be used; if flow soldering method is preferred, please consult with the ROHM representative in advance.

For details, please refer to ROHM Mounting specification

Precautions Regarding Application Examples and External Circuits

1. If change is made to the constant of an external circuit, please allow a sufficient margin considering variations of the characteristics of the Products and external components, including transient characteristics, as well as static characteristics.
2. You agree that application notes, reference designs, and associated data and information contained in this document are presented only as guidance for Products use. Therefore, in case you use such information, you are solely responsible for it and you must exercise your own independent verification and judgment in the use of such information contained in this document. ROHM shall not be in any way responsible or liable for any damages, expenses or losses incurred by you or third parties arising from the use of such information.

Precaution for Electrostatic

This Product is electrostatic sensitive product, which may be damaged due to electrostatic discharge. Please take proper caution in your manufacturing process and storage so that voltage exceeding the Products maximum rating will not be applied to Products. Please take special care under dry condition (e.g. Grounding of human body / equipment / solder iron, isolation from charged objects, setting of ionizer, friction prevention and temperature / humidity control).

Precaution for Storage / Transportation

1. Product performance and soldered connections may deteriorate if the Products are stored in the places where:
 - [a] the Products are exposed to sea winds or corrosive gases, including Cl₂, H₂S, NH₃, SO₂, and NO₂
 - [b] the temperature or humidity exceeds those recommended by ROHM
 - [c] the Products are exposed to direct sunshine or condensation
 - [d] the Products are exposed to high Electrostatic
2. Even under ROHM recommended storage condition, solderability of products out of recommended storage time period may be degraded. It is strongly recommended to confirm solderability before using Products of which storage time is exceeding the recommended storage time period.
3. Store / transport cartons in the correct direction, which is indicated on a carton with a symbol. Otherwise bent leads may occur due to excessive stress applied when dropping of a carton.
4. Use Products within the specified time after opening a humidity barrier bag. Baking is required before using Products of which storage time is exceeding the recommended storage time period.

Precaution for Product Label

QR code printed on ROHM Products label is for ROHM's internal use only.

Precaution for Disposition

When disposing Products please dispose them properly using an authorized industry waste company.

Precaution for Foreign Exchange and Foreign Trade act

Since our Products might fall under controlled goods prescribed by the applicable foreign exchange and foreign trade act, please consult with ROHM representative in case of export.

Precaution Regarding Intellectual Property Rights

1. All information and data including but not limited to application example contained in this document is for reference only. ROHM does not warrant that foregoing information or data will not infringe any intellectual property rights or any other rights of any third party regarding such information or data. ROHM shall not be in any way responsible or liable for infringement of any intellectual property rights or other damages arising from use of such information or data.:
2. No license, expressly or implied, is granted hereby under any intellectual property rights or other rights of ROHM or any third parties with respect to the information contained in this document.

Other Precaution

1. This document may not be reprinted or reproduced, in whole or in part, without prior written consent of ROHM.
2. The Products may not be disassembled, converted, modified, reproduced or otherwise changed without prior written consent of ROHM.
3. In no event shall you use in any way whatsoever the Products and the related technical information contained in the Products or this document for any military purposes, including but not limited to, the development of mass-destruction weapons.
4. The proper names of companies or products described in this document are trademarks or registered trademarks of ROHM, its affiliated companies or third parties.

General Precaution

1. Before you use our Products, you are requested to carefully read this document and fully understand its contents. ROHM shall not be in any way responsible or liable for failure, malfunction or accident arising from the use of any ROHM's Products against warning, caution or note contained in this document.
2. All information contained in this document is current as of the issuing date and subject to change without any prior notice. Before purchasing or using ROHM's Products, please confirm the latest information with a ROHM sales representative.
3. The information contained in this document is provided on an "as is" basis and ROHM does not warrant that all information contained in this document is accurate and/or error-free. ROHM shall not be in any way responsible or liable for any damages, expenses or losses incurred by you or third parties resulting from inaccuracy or errors of or concerning such information.