

Description

The device is intended to take 1 or 2 reference clocks, select between them, using a pin or register selection and generate up to 8 outputs that may be the same as the reference frequency or integer-divider versions of it.

The 8P79818 supports two output banks, each with its own divider and power supply. All outputs in one bank would generate the same output frequency, but each output can be individually controlled for output type, output enable or even powered-off.

The device supports a serial port for configuration of the parameters while in operation. The serial port can be selected to use the I²C or SPI protocol. After power-up, all outputs will come up in LVDS mode and may be programmed to other configurations over the serial port. Outputs may be enabled or disabled under control of the OE input pin.

The device can operate over the -40°C to +85°C temperature range.

Features

- Two differential inputs support LVPECL, LVDS, HCSL or LVCMOS reference clocks
 - Accepts input frequencies ranging from 1PPS (1Hz) to 700MHz
- Select which of the two input clocks is to be used as the reference clock for which divider via pin or register selection
 - Switchover will not generate any runt clock pulses on the output
- Generates eight differential outputs or eight LVCMOS outputs, Bank A only
 - Differential outputs selectable as LVPECL, LVDS, CML or HCSL
 - Differential outputs support frequencies from 1PPS to 700MHz
 - LVCMOS outputs support frequencies from 1PPS to 200MHz
 - LVCMOS outputs in the same pair may be inverted or in-phase relative to one another
- Outputs arranged in 2 banks of 4 outputs each
 - Each bank supports a separate power supply of 3.3V, 2.5V or 1.8V
 - 1.5V output voltage is also supported for LVCMOS, Bank A only
 - One divider per output bank, supporting divide ratios of 2...511 or divider bypass
- Output enable control pin
 - Output enable or disable will not cause any runt pulses
- Register programmable via I²C / SPI serial port
 - Individual output enables, output type selection and output power-down control bits supported
 - Input mux selection control bit
- Core voltage supply of 3.3V, 2.5V or 1.8V
- -40°C to +85°C ambient operating temperature
- Lead-free (RoHS 6) packaging

Block Diagram

Figure 1: Block Diagram

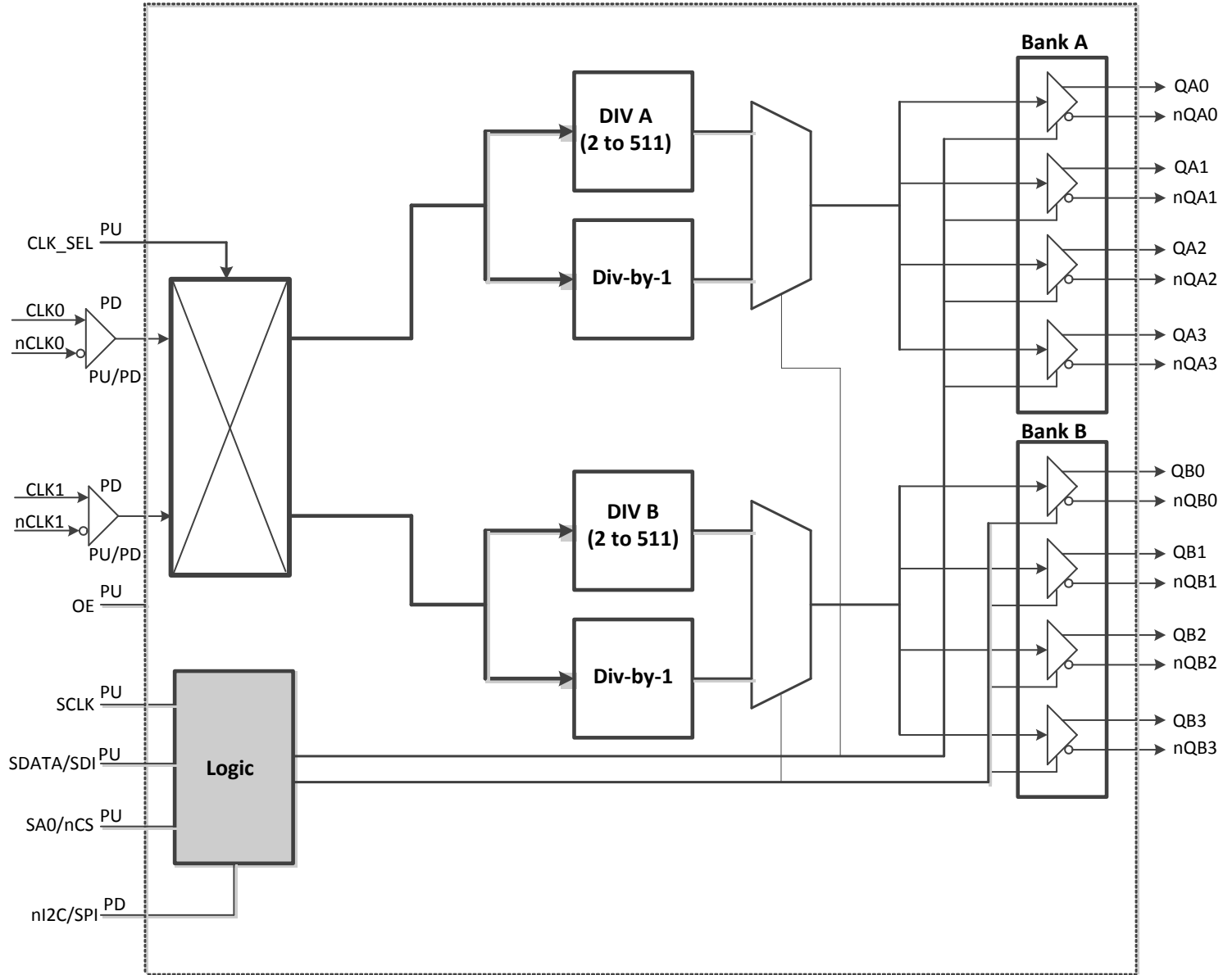

8P79818 transistor count: 33,394

Pin Assignment

Figure 2: Pin Assignments for 5mm x 5mm 32-Lead VFQFN Package (Top View)

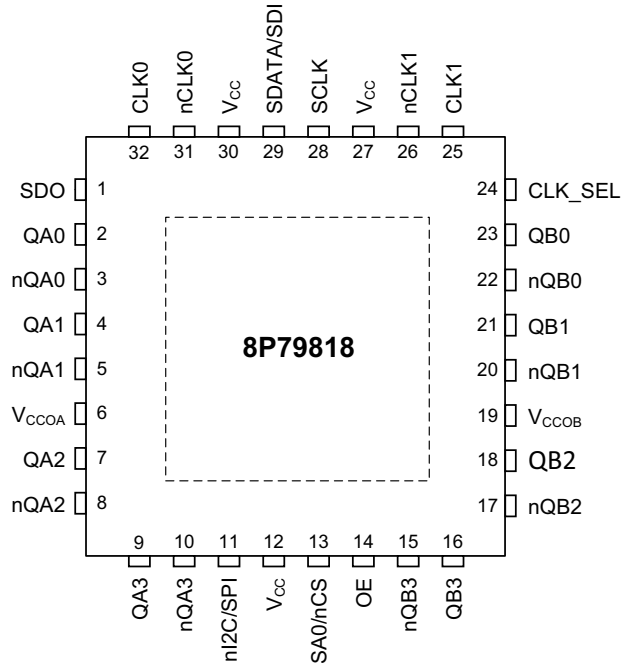

Pin Description and Characteristic Tables

Table 1: Pin Description

Number	Name	Type ^[a]	Description
1	SDO	Output	SPI mode data output signal. Unused in I ² C mode.
2	QA0	Output	Positive differential clock output. Included in Bank A. Refer to Output Drivers section for details.
3	nQA0	Output	Negative differential clock output. Included in Bank A. Refer to Output Drivers section for details.
4	QA1	Output	Positive differential clock output. Included in Bank A. Refer to Output Drivers section for details.
5	nQA1	Output	Negative differential clock output. Included in Bank A. Refer to Output Drivers section for details.
6	V _{CCOA}	Power	Output supply for output Bank A.
7	QA2	Output	Positive differential clock output. Included in Bank A. Refer to Output Drivers section for details.
8	nQA2	Output	Negative differential clock output. Included in Bank A. Refer to Output Drivers section for details.
9	QA3	Output	Positive differential clock output. Included in Bank A. Refer to Output Drivers section for details.
10	nQA3	Output	Negative differential clock output. Included in Bank A. Refer to Output Drivers section for details.
11	nI2C/SPI	Input (PD)	Select protocol for serial port: 0 = I ² C mode 1 = SPI mode
12	V _{CC}	Power	Core logic supply.
13	SA0/nCS	Input (PU)	SPI chip select input (active low) in SPI mode. Base address bit 0 in I ² C mode.

Table 1: Pin Description (Cont.)

14	OE	Input (PU)	Master output enable control 0 = All outputs high-impedance 1 = All outputs enabled or disabled under control of register bits
15	nQB3	Output	Negative differential clock output. Included in Bank B. Refer to Output Drivers section for details.
16	QB3	Output	Positive differential clock output. Included in Bank B. Refer to Output Drivers section for details.
17	nQB2	Output	Negative differential clock output. Included in Bank B. Refer to Output Drivers section for details.
18	QB2	Output	Positive differential clock output. Included in Bank B. Refer to Output Drivers section for details.
19	V _{CCOB}	Power	Output supply for output Bank B.
20	nQB1	Output	Negative differential clock output. Included in Bank B. Refer to Output Drivers section for details.
21	QB1	Output	Positive differential clock output. Included in Bank B. Refer to Output Drivers section for details.
22	nQB0	Output	Negative differential clock output. Included in Bank B. Refer to Output Drivers section for details.
23	QB0	Output	Positive differential clock output. Included in Bank B. Refer to Output Drivers section for details.
24	CLK_SEL	Input (PU)	Input clock selection control pin. This pin may be disabled by register control, but if enabled (default) its function is: 0 = CLK0 is selected 1 = CLK1 is selected
25	CLK1	Input (PD)	Non-inverting differential clock input.
26	nCLK1	Input (PU/ PD)	Inverting differential clock input. V _{CC} /2 when left floating (set by the internal pull-up and pull-down resistors).
27	V _{CC}	Power	Core logic supply.
28	SCLK	Input (PU)	Serial port input clock for either SPI or I ² C mode.
29	SDATA/ SDI	Input/Output (PU) Input (PU)	In I ² C mode, this is the bi-directional data signal for the serial port In SPI mode, this is the data input signal.
30	V _{CC}	Power	Core logic supply.
31	nCLK0	Input (PU/ PD)	Inverting differential clock input. V _{CC} /2 when left floating (set by the internal pull-up and pull-down resistors).
32	CLK0	Input (PD)	Non-inverting differential clock input.
EP	V _{EE}	Ground	Must be connected to ground (GND).

a. Pull-up (PU) and pull-down (PD) resistors are indicated in parentheses. *Pullup* and *Pulldown* refer to internal input resistors. See [Table 10, DC Input/ Output Characteristics](#), for typical values.

Principles of Operation

Input Selection

The 8P79818 supports two input references: CLK0 and CLK1 that may be driven with differential or single-ended clock signals. Either or both may be used as the source frequency for either output divider under control of the CLK_SEL input pin or under register control.

The CLK_SEL pin is the default selection mechanism and selects whether both dividers are driven by the CLK0, nCLK0 input (CLK_SEL = Low) or by the CLK1, nCLK1 input (CLK_SEL = High).

If the user enables register control via the SEL_REG control bit, then there are 4 selection options available as shown in [Table 2](#).

Table 2: Input Selection Register Control (SEL_REG = 1)

CLK_SEL [1:0]		Description
0	0	Divider A & B both driven from CLK0
0	1	Divider A driven from CLK1 & Divider B driven from CLK0
1	0	Divider A driven from CLK0 & Divider B driven from CLK1
1	1	Divider A & B both driven from CLK1

Output Dividers

Each bank of outputs has its own divider. All outputs in the same bank will be driven by that divider and so will all have the same frequency. Divider A supplies the QA output bank and Divider B supplies the QB output bank. Each divider is capable of being driven by the same or a different input frequency. Each divider can pass that input frequency directly to the outputs or to divide it by any integer from 2 up to 511.

Output Drivers

The QA[0:3] and QB[0:3] clock outputs are provided with register-controlled output drivers. By selecting the output drive type in the appropriate register, any of these outputs can support LVCMOS, LVPECL, CML, HCSL or LVDS logic levels.

CML operation supports both a 400mV peak-peak swing and an 800mV peak-peak swing selection.

The operating voltage ranges of each output bank is determined by its independent output power pin (V_{CCOA} or V_{CCOB}). Output voltage levels of 1.8V, 2.5V or 3.3V are supported for differential operation and LVCMOS operation. In addition, LVCMOS output operation supports 1.5V V_{CCO} .

A global OE input pin is provided. If the OE pin is negated (Low), then all outputs will be in a high-impedance state. If the OE pin is asserted (High), then each output will behave as indicated by its individual register enable bit. Using the global OE pin to enable or disable outputs will not result in any 'runt' clock pulses on the outputs.

Each output bank may be enabled or disabled using the SYNC_DISx register bit. Using these bits to enable or disable outputs will not result in any 'runt' clock pulses on the outputs.

Individual outputs within a bank may be enabled or disabled using the DIS_Qxm register bits. These bits however may result in 'runt' pulses on the outputs if the output is otherwise enabled, so it is recommended that the entire bank be disabled via the appropriate SYNC_DISx register bit while an individual output is being enabled using the DIS_Qxm bit to avoid a possible 'runt' pulse on the output. If 'runt' pulses are not a concern, then the DIS_Qxm bits may be used directly.

LVCMOS Operation

When a given output is configured to provide LVCMOS levels, then both the Q and nQ outputs will toggle at the selected output frequency. All the previously described configuration and control apply equally to both outputs. Frequency, voltage levels and enable / disable status apply to both the Q and nQ pins.

When configured as LVCMOS, the Q & nQ outputs can be selected to be phase-aligned with each other or inverted relative to one another. Phase-aligned outputs will have increased simultaneous switching currents which can negatively affect phase noise performance and power consumption. It is recommended that use of this selection be kept to a minimum.

Power-Saving Modes

To allow the device to consume the least power possible for a given application, the following functions are included under register control:

- Any unused output can be individually powered-off.
- If either bank is completely unused, all logic, including the dividers for that bank may be completely powered-off.
- Clock gating on logic that is not being used.

Device Start-up Behavior

The device will power-up with all outputs enabled in LVDS mode and all dividers bypassed.

Serial Control Port Description

Serial Control Port Configuration Description

The device has a serial control port capable of responding as a slave in an I²C or SPI compatible configuration, to allow access to any of the internal registers for device programming or examination of internal status. All registers are configured to have default values. See the specifics for each register for details. Selection of I²C versus SPI protocol will be done via the I²C/SPI input pin.

SPI Mode Operation

SPI mode can be enabled via pin selection from power-up. The following information assumes SPI mode has been selected.

In a read operation (R/W bit is '1'), data on SDO will be clocked out on the falling edge of SCLK.

In a write operation (R/W bit is '0'), data on SDI will be clocked in on the rising edge of SCLK.

Figure 3: SPI Read Sequencing Diagram

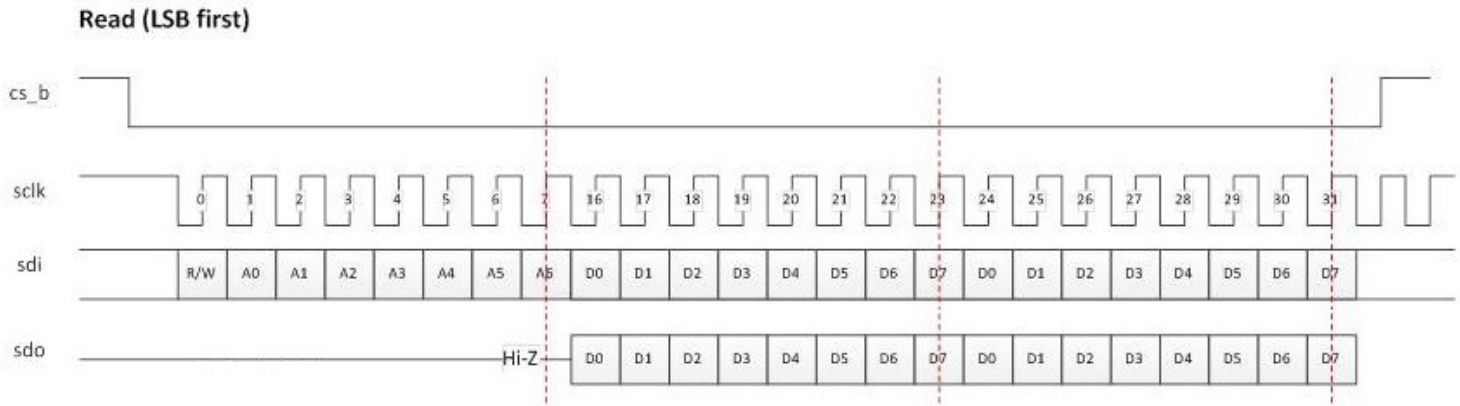

During SPI Write operations, the user may continue to hold nCS low and provide further bytes of data for up to a total of 16 bytes in a single block write. Data is written directly into the appropriate register as it is received.

Figure 4: SPI Write Sequencing Diagram
Write (LSB first)

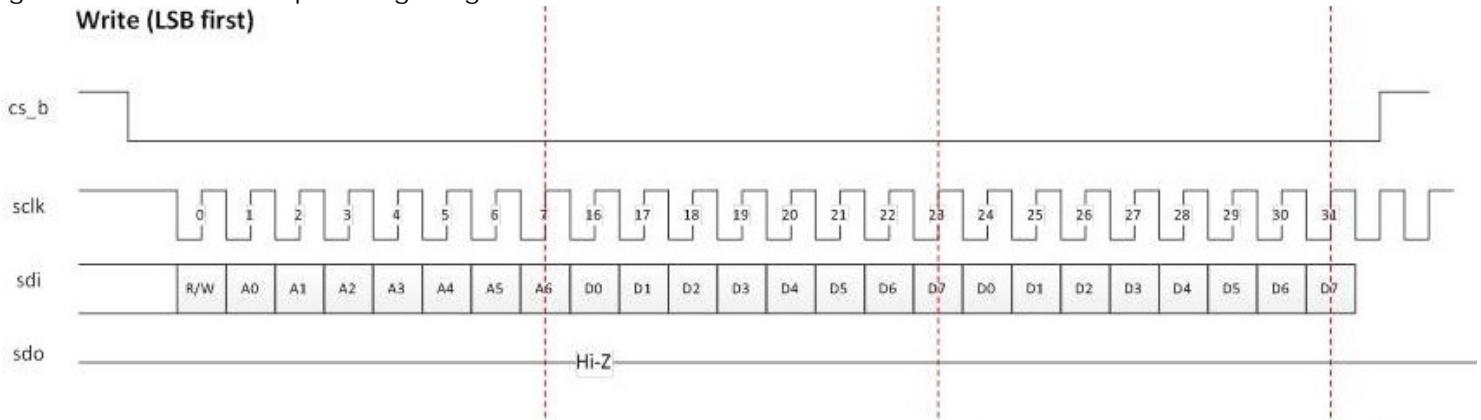

Figure 5: SPI Read/Write Timing Diagram

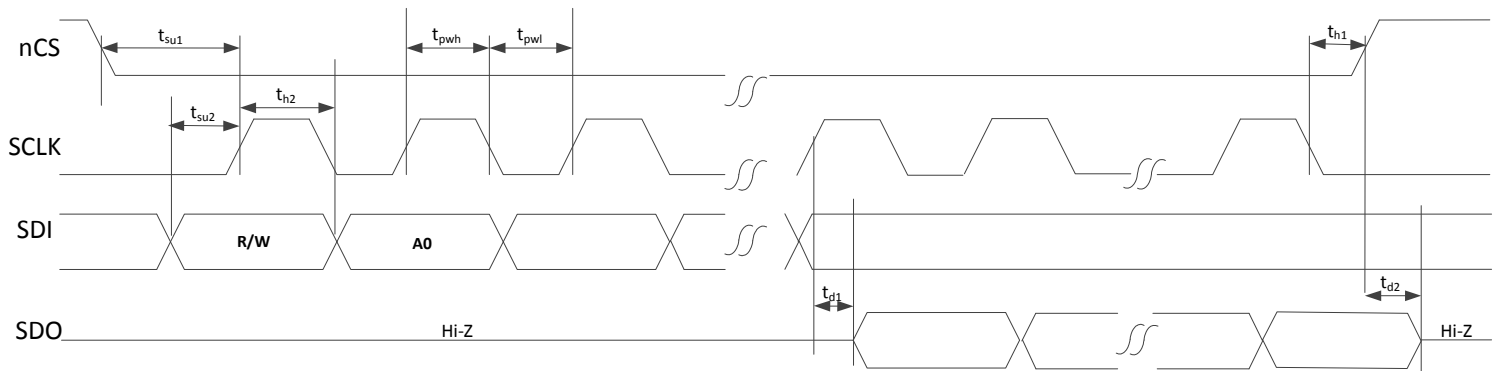

Table 3: Timing Characteristics in SPI Mode^[a]

Symbol	Parameter	Min	Typ	Max	Unit
t_{pw}	SCLK Period	20			ns
t_{pw1}	SCLK Pulse Width Low	8			ns
t_{pw2}	SCLK Pulse Width High	8			ns
t_{su1}	Valid nCS to SCLK Rising Setup Time	10			ns
t_{h1}	Valid nCS After Valid SCLK Hold Time (CLKE = 0/1)	10			ns
t_{su2}	Valid SDI to SCLK Rising Setup Time	5			ns
t_{h2}	Valid SDI after valid SCLK Hold Time	5			ns
t_{d1}	SCLK falling (rising in CLKE = 1 case) to Valid Data Delay Time			5	ns
t_{d2}	nCS rising edge to SDO High Impedance Delay Time			10	ns
t_{csh}	Time between Consecutive Read-Read or Read-Write Accesses (nCS rising edge to nCS falling edge)	20			ns

a. Specifications guaranteed by design and characterization.

I²C Mode Operation

The I²C interface is designed to fully support v1.0 of the I²C specification for *normal* and *fast* mode operation. The device acts as a slave device on the I²C bus at 100kHz or 400kHz using an address of 110110x (binary), where the value of 'x' is set by the SA0/nCS input pin. The interface accepts byte-oriented block write and block read operations. One address byte specifies the register address of the byte position of the first register to write or read. Data bytes (registers) are accessed in sequential order from the lowest to the highest byte (most significant bit first). Read and write block transfers can be stopped after any complete byte transfer. During a write operation, data will be written to the registers directly as each byte is received.

For full electrical I²C compliance, it is recommended to use external pull-up resistors for SDATA and SCLK. The internal pull-up resistors have a size of 51kΩ typical.

Figure 6: Slave Read and Write Cycle Sequencing

Current Read

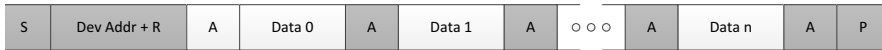

Sequential Read

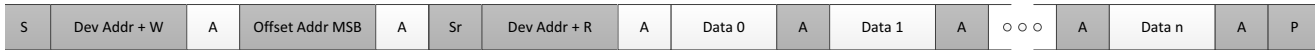

Sequential Write



- from master to slave
- from slave to master

S = start
 Sr = repeated start
 A = acknowledge
 \bar{A} = none acknowledge
 P = stop

Register Descriptions

Table 4: Register Blocks

Register Ranges Offset (Hex)	Register Block Description
0 – 1	Device control
2 – 5	Bank A control
6 – 9	Bank B control
A – B	Reserved
C – F	Divide ratios

Table 5: Device Control Register Bit Field Locations

Address (Hex)	D7	D6	D5	D4	D3	D2	D1	D0
0	CLKMODE	CLK_SEL[1:0]		SEL_REG	Rsvd	Rsvd	Rsvd	DIV_SYNC
1	BKA_Vx	BKB_Vx	SYNC_DISA	SYNC_DISB	PWR_DNA	PWR_DNB	DIS_DIVA	DIS_DIVB

Bit Field Name	Field Type	Default Value	Description
CLKMODE	R/W	0b	Clock switchover mode selection: 0 = Forced clock switch (may result in glitches as clocks switch) 1 = Glitch-less clock switch (may remain on original clock source if that source is no longer toggling)
CLK_SEL[1:0]	R/W	00b	Select which input clock is to be used as the reference clock. These bits are only in effect when SEL_REG = 1: 00 = CLK0, nCLK0 input drives both Divider A & Divider B 01 = CLK1, nCLK1 input drives Divider A & CLK0, nCLK0 drives Divider B 10 = CLK0, nCLK0 input drives Divider A & CLK1, nCLK1 drives Divider B 11 = CLK1, nCLK1 input drives both Divider A & Divider B
SEL_REG	R/W	0b	Determines if input clock selection is to be performed by pin or register: 0 = CLK_SEL input pin controls reference selection mux 1 = CLK_SEL register bits controls reference selection mux
Rsvd	R/W	–	Reserved. Always write '0' to this bit location. Read values are not defined.
DIV_SYNC	R/W	0b	Divider synchronization control: 0 = Dividers running normally 1 = Dividers in reset (output clocks halted) 1→0 transition on this bit will synchronize the Bank A & Bank B output dividers
BKA_Vx	R/W	0b	Bank A voltage setting for optimal performance: 0 = V _{CCOA} is 3.3V 1 = V _{CCOA} is 2.5V, 1.8V, and 1.5V
BKB_Vx	R/W	0b	Bank B voltage setting for optimal performance: 0 = V _{CCOB} is 3.3V 1 = V _{CCOB} is 2.5V, 1.8V
SYNC_DISA	R/W	0b	Glitch-free output enable bit for Bank A outputs: 0 = Outputs in Bank A are enabled glitch-lessly as indicated by their individual DIS_QAm bits 1 = All outputs for Bank A are high-impedance
SYNC_DISB	R/W	0b	Glitch-free output enable bit for Bank B outputs: 0 = Outputs in Bank B are enabled glitch-lessly as indicated by their individual DIS_QBm bits 1 = All outputs for Bank B are high-impedance

Bit Field Name	Field Type	Default Value	Description
PWR_DNA	R/W	0b	Power-down control for Bank A outputs: 0 = All outputs for Bank A are powered (SYNC_DISA should be 1 when powering-up the bank to prevent glitches on the output) 1 = All outputs in Bank A are powered-off
PWR_DNB	R/W	0b	Power-down control for Bank B outputs: 0 = All outputs for Bank B are powered (SYNC_DISB should be 1 when powering-up the bank to prevent glitches on the output) 1 = All outputs in Bank B are powered-off
DIS_DIVA	R/W	0b	Power-down output divider for Bank A (DIVA must be set to 000h to bypass): 0 = Output divider for Bank A is powered 1 = Output divider for Bank A is powered-down
DIS_DIVB	R/W	0b	Power-down output divider for Bank B (DIVB must be set to 000h to bypass): 0 = Output divider for Bank B is powered 1 = Output divider for Bank B is powered-down

Table 6: Bank A Control Register Bit Field Locations

Address (Hex)	D7	D6	D5	D4	D3	D2	D1	D0
2	Rsvd			TERM_A	QA_POL3	QA_POL2	QA_POL1	QA_POL0
3	Rsvd		MODE_QA3[2:0]			MODE_QA2[2:0]		
4	Rsvd		MODE_QA1[2:0]			MODE_QA0[2:0]		
5	DIS_QA3	DIS_QA2	DIS_QA1	DIS_QA0	Rsvd			

Bit Field Name	Field Type	Default Value	Description
TERM_A	R/W	0b	Indicates termination used on Bank A outputs when HCSL mode is selected: 0 = 33Ω/ 50Ω 1 = 50Ω
QA_POLm	R/W	0h	Output polarity selection for output pair nQAm, QAm in LVCMOS mode: 0 = nQAm pin is inverted relative to QAm pin when in LVCMOS mode 1 = nQAm and QAm pins are in-phase when in LVCMOS mode
MODE_QAm[2:0]	R/W	010b	Output driver mode of operation for output pair QAm, nQAm: 000 = high-impedance 001 = LVPECL 010 = LVDS (default) 011 = LVCMOS 100 = HCSL 101 = CML 400mV swing 110 = CML 800mV swing 111 = Reserved
DIS_QAm	R/W	0b	Disable output pair QAm, nQAm: 0 = Output pair QAm, nQAm is enabled (disable output bank using SYNC_DISA to prevent runt pulses when enabling) 1 = Output pair QAm, nQAm is powered-down
Rsvd	R/W	–	Reserved. Always write 0 to this bit location. Read values are not defined.

Table 7: Bank B Control Register Bit Field Locations

Address (Hex)	D7	D6	D5	D4	D3	D2	D1	D0
6	Rsvd			TERM_B	Rsvd	Rsvd	Rsvd	Rsvd
7	Rsvd		MODE_QB3[2:0]			MODE_QB2[2:0]		
8	Rsvd		MODE_QB1[2:0]			MODE_QB0[2:0]		
9	DIS_QB3	DIS_QB2	DIS_QB1	DIS_QB0	Rsvd			

Bit Field Name	Field Type	Default Value	Description
TERM_B	R/W	0b	Indicates termination used on Bank B outputs when HCSL mode is selected: 0 = 33Ω/ 50Ω 1 = 50Ω
MODE_QBm[2:0]	R/W	010b	Output driver mode of operation for output pair QBm, nQBm: 000 = high-impedance 001 = LVPECL 010 = LVDS (default) 011 = Rsvd 100 = HCSL 101 = CML 400mV swing 110 = CML 800mV swing 111 = Reserved
DIS_QBm	R/W	0b	Disable output pair QBm, nQBm: 0 = Output pair QBm, nQBm is enabled (disable output bank using SYNC_DISB to prevent runt pulses when enabling) 1 = Output pair QBm, nQBm is powered-down
Rsvd	R/W	–	Reserved. Always write 0 to this bit location. Read values are not defined.

Table 8: Divide Ratio Register Field Locations

Address (Hex)	D7	D6	D5	D4	D3	D2	D1	D0
C	DIVA[7:0]							
D	DIVB[7:0]							
E	Rsvd						DIVB[8]	DIVA[8]
F	Rsvd							

Bit Field Name	Field Type	Default Value	Description
DIVA[8:0]	R/W	000h	<p>Divider ratio for Bank A outputs:</p> <p>00h – 01h = Bypass divider and pass reference clock directly to the Bank A outputs</p> <p>02h – 1FFh = ratio to be used by the A divider is value written here. For example writing a 4 in this field will results in a divide ratio of 4 being used.</p>
DIVB[8:0]	R/W	000h	<p>Divider ratio for Bank B outputs:</p> <p>00h – 01h = Bypass divider and pass reference clock directly to the Bank B outputs</p> <p>02h – 1FFh = ratio to be used by the B divider is value written here. For example writing a 4 in this field will results in a divide ratio of 4 being used.</p>
Rsvd	R/W	–	Reserved. Always write 0 to this bit location. Read values are not defined.

Absolute Maximum Ratings

The absolute maximum ratings are stress ratings only. Stresses greater than those listed below can cause permanent damage to the device. Functional operation of the 8P79818 at absolute maximum ratings is not implied. Exposure to absolute maximum rating conditions may affect device reliability.

Table 9: Absolute Maximum Ratings

Item	Rating
Supply voltage, V_{CCX} ^[a] to GND	3.6V
Inputs SCLK, SDATA/SDI, SA0/nCS, CLK_SEL, CLK0, nCLK0, CLK1, nCLK1, OE, nI2C/SPI	-0.5V to 3.6V
Outputs, I_O QA[0:3], nQA[0:3], QB[0:3], nQB[0:3] Continuous current Surge current	40mA 60mA
Outputs, V_O QA[0:3], nQA[0:3], QB[0:3], nQB[0:3]	-0.5V to 3.6V
Outputs, V_O SDO, SDATA/SDI	-0.5V to 3.6V
Operating junction temperature	125°C
Storage temperature, T_{STG}	-65°C to 150°C
Lead temperature (Soldering, 10s)	+260°C

a. V_{CCX} denotes V_{CC} , V_{CCOA} , or V_{CCOB} .

DC Characteristics

Table 10: DC Input/ Output Characteristics

Symbol	Parameter		Test Conditions	Minimum	Typical	Maximum	Units	
C_{in}	Input capacitance				0.5		pF	
C_{PD}	Power dissipation capacitance (per output)	LVPECL	QA[0:3], nQA[0:3] QB[0:3], nQB[0:3]	$V_{CCOX}^{[a]} = 3.465V$ or $2.625V$		0.8		pF
		LVDS				1.2		pF
		CML 400mV				0.48		pF
		CML 800mV				0.44		pF
		LVC MOS	Bank A	$V_{CCOA} = 3.465V$ or $2.625V$		2.33		pF
		LVPECL	QA[0:3], nQA[0:3] QB[0:3], nQB[0:3]	$V_{CCOX} = 1.89V$		1.4		pF
		LVDS				1.5		pF
		CML 400mV				0.53		pF
		CML 800mV				0.3		pF
		LVC MOS	Bank A	$V_{CCOA} = 1.89V$ or $1.575V$		2.1		pF
R_{PULLUP}	Input pull-up resistor				51		k Ω	
$R_{PULLDOWN}$	Input pull-down resistor				51		k Ω	
R_{OUT}	Output impedance	QA[3:0], nQA[3:0]	LVC MOS output type selected $V_{CCOA} = 3.3V \pm 5\%$		24		Ω	
			LVC MOS output type selected $V_{CCOA} = 2.5V \pm 5\%$		15		Ω	
			LVC MOS output type selected $V_{CCOA} = 1.8V \pm 5\%$		26		Ω	
			LVC MOS output type selected $V_{CCOA} = 1.5V \pm 5\%$		46		Ω	

a. V_{CCOX} denotes V_{CCOA} and V_{CCOB} .

Supply Voltage Characteristics

Table 11: Power Supply Characteristics, $V_{CC} = 3.3V \pm 5\%$, $V_{EE} = 0V$, $T_A = -40^\circ C$ to $+85^\circ C$ ^{[a], [b], [c]}

Symbol	Parameter	Test Conditions	Minimum	Typical	Maximum	Units
V_{CC}	Core supply voltage		3.135		3.465	V
V_{CCOA} , V_{CCOB}	Output supply voltage		1.71		V_{CC}	V
I_{CC}	Core supply current			23	26	mA
$I_{CCOA} +$ I_{CCOB}	Output supply current	DIV-by-1		157	177	mA
		DIV A = DIV B = 2		125	140	mA
I_{EE}	Power supply current			183	206	mA

- a. Internal dynamic switching current at maximum f_{OUT} is included.
- b. All outputs configured for LVEPCL logic levels and not terminated.
- c. $V_{CC} \geq V_{CCOA}$ and V_{CCOB} .

Table 12: Power Supply Characteristics, $V_{CC} = 2.5V \pm 5\%$, $V_{EE} = 0V$, $T_A = -40^\circ C$ to $+85^\circ C$ ^{[a], [b], [c]}

Symbol	Parameter	Test Conditions	Minimum	Typical	Maximum	Units
V_{CC}	Core supply voltage		2.375		2.625	V
V_{CCOA} , V_{CCOB}	Output supply voltage		1.71		V_{CC}	V
I_{CC}	Core supply current			18	20	mA
$I_{CCOA} +$ I_{CCOB}	Output supply current	DIV-by-1		156	175	mA
		DIV A = DIV B = 2		124	139	mA
I_{EE}	Power supply current			177	199	mA

- a. Internal dynamic switching current at maximum f_{OUT} is included.
- b. All outputs configured for LVEPCL logic levels and not terminated.
- c. $V_{CC} \geq V_{CCOA}$ and V_{CCOB} .

Table 13: Power Supply Characteristics, $V_{CC} = 1.8V \pm 5\%$, $V_{EE} = 0V$, $T_A = -40^\circ C$ to $+85^\circ C$ ^[a], [b], [c]

Symbol	Parameter	Test Conditions	Minimum	Typical	Maximum	Units
V_{CC}	Core supply voltage		1.71		1.89	V
V_{CCOA} , V_{CCOB}	Output supply voltage		1.71		V_{CC}	V
I_{CC}	Core supply current			14	16	mA
$I_{CCOA} + I_{CCOB}$	Output supply current	DIV-by-1		143	160	mA
		DIV A = DIV B = 2		117	132	mA
I_{EE}	Power supply current			161	181	mA

- a. Internal dynamic switching current at maximum f_{OUT} is included.
- b. All outputs configured for LVEPCL logic levels and not terminated.
- c. $V_{CC} \geq V_{CCOA}$ and V_{CCOB} .

 Table 14: Output Supply Current, $V_{CC} = 3.3V$, $2.5V$ or $1.8V$, $V_{EE} = 0V$, $T_A = 25^\circ C$ ^[a], [b]

Symbol	Parameter ^[c]	Test Conditions	$V_{CCOx}^{[d]} = 3.3V$					$V_{CCOx}^{[d]} = 2.5V$					$V_{CCOx}^{[d]} = 1.8V$					Units	
			LVPECL	LVDS	HCSL	LVC MOS	CML	LVPECL	LVDS	HCSL	LVC MOS	CML (400mV)	LVPECL	LVDS	HCSL	LVC MOS	CML (400mV)		LVC MOS
I_{CCOA}	Bank A output supply current	$V_{CC} = 3.3V$, $T_A = 25^\circ C$	76	96	73	119	60	75	96	67	92	58	68	87	66	72	53	60	mA
		$V_{CC} = 3.3V \pm 5\%$, $T_A = 85^\circ C$	88	114	87	149	70	88	113	85	111	67	80	104	78	86	63	71	mA
I_{CCOB}	Bank B output supply current	$V_{CC} = 3.3V$, $T_A = 25^\circ C$	76	96	73	119	60	75	96	67	92	58	68	87	66	72	53	60	mA
		$V_{CC} = 3.3V$, $T_A = 85^\circ C$	88	114	87	149	70	88	113	85	111	67	80	104	78	86	63	71	mA

- a. All outputs not terminated.
- b. $V_{CC} \geq V_{CCOA}$ and V_{CCOB} .
- c. Internal dynamic switching current at maximum f_{OUT} is included.
- d. V_{CCOx} denotes V_{CCOA} and V_{CCOB} .

DC Electrical Characteristics

Table 15: LVCMOS/LVTTL Control / Status Signals DC Characteristics, $V_{EE} = 0V$, $T_A = -40^{\circ}C$ to $+85^{\circ}C$

Symbol	Parameter		Test Conditions	Minimum	Typical	Maximum	Units
V_{IH}	Input high voltage		$V_{CC} = 3.3V$	2.20		$V_{CC} + 0.3$	V
			$V_{CC} = 2.5V$	1.85		$V_{CC} + 0.3$	V
			$V_{CC} = 1.8V$	1.25		$V_{CC} + 0.3$	V
V_{IL}	Input low voltage		$V_{CC} = 3.3V$	-0.3		0.8	V
			$V_{CC} = 2.5V$	-0.3		0.7	V
			$V_{CC} = 1.8V$	-0.3		0.7	V
I_{IH}	Input high current	SA0/nCS, SDATA/SDI, SCLK, CLK_SEL, OE	$V_{CC} = V_{IN} = 3.465V, 2.625V$ or $1.89V$			5	μA
		nI2C/SPI				150	μA
I_{IL}	Input low current	SA0/nCS, SDATA/SDI, SCLK, CLK_SEL, OE	$V_{CC} = 3.465V, 2.625V$ or $1.89V$, $V_{IN} = 0V$	-150			μA
		nI2C/SPI		-5			μA
V_{OH}	Output high voltage	SDATA/SDI, SDO	$V_{CC} = 3.3V \pm 5\%$, $I_{OH} = -5mA$	2.6			V
			$V_{CC} = 2.5V \pm 5\%$, $I_{OH} = -5mA$	1.8			V
			$V_{CC} = 1.8V \pm 5\%$, $I_{OH} = -5mA$				V
V_{OL}	Output low voltage	SDATA/SDI, SDO	$V_{CC} = 3.3V \pm 5\%$ or $2.5V \pm 5\%$ or $1.8V \pm 5\%$, $I_{OL} = 5mA$			0.5	V

Table 16: Differential Input DC Characteristics, $V_{CC} = 3.3V \pm 5\%$, $2.5V \pm 5\%$ or $1.8V \pm 5\%$, $V_{EE} = 0V$, $T_A = -40^{\circ}C$ to $+85^{\circ}C$

Symbol	Parameter		Test Conditions	Minimum	Typical	Maximum	Units
I_{IH}	Input high current	CLKx, nCLKx ^[a]	$V_{CC} = V_{IN} = 3.465V$ or $2.625V$			150	μA
I_{IL}	Input low current	CLKx ^[a]	$V_{CC} = 3.465V$ or $2.625V$, $V_{IN} = 0V$	-5			μA
		nCLKx ^[a]	$V_{CC} = 3.465V$ or $2.625V$, $V_{IN} = 0V$	-150			μA
V_{PP}	Peak-to-peak voltage ^[b]			0.15		1.3	V
V_{CMR}	Common mode input voltage ^{[b], [c]}			0		V_{CC}	V

- a. CLKx denotes CLK0, CLK1. nCLKx denotes nCLK0, nCLK1.
 b. V_{IL} should not be less than $-0.3V$. V_{IH} should not be higher than V_{CC} .
 c. Common mode voltage is defined as the cross-point.

Table 17: LVPECL DC Characteristics, $V_{CC} = 3.3V \pm 5\%$, $2.5V \pm 5\%$ or $1.8V \pm 5\%$, $V_{EE} = 0V$, $T_A = -40^\circ C$ to $+85^\circ C$

Symbol	Parameter		$V_{CCOx}^{[a]} = 3.3V \pm 5\%$			$V_{CCOx}^{[a]} = 2.5V \pm 5\%$			$V_{CCOx}^{[a]} = 1.8V \pm 5\%$			Units
			Min	Typ	Max	Min	Typ	Max	Min	Typ	Max	
V_{OH}	Output high voltage ^[b]	$Qx, nQx^{[c]}$	$V_{CCOx} - 1.30$		$V_{CCOx} - 0.80$	$V_{CCOx} - 1.35$		$V_{CCOx} - 0.80$	$V_{CCOx} - 1.50$		$V_{CCOx} - 0.90$	V
V_{OL}	Output low voltage	$Qx, nQx^{[c]}$	$V_{CCOx} - 2.00$		$V_{CCOx} - 1.75$	$V_{CCOx} - 2.00$		$V_{CCOx} - 1.75$	V_{EE}		0.25	V

a. V_{CCOx} denotes V_{CCOA} and V_{CCOB} .

b. Outputs terminated with 50Ω to $V_{CCOx} - 2V$ when $V_{CCOx} = 3.3V \pm 5\%$ or $2.5V \pm 5\%$. Outputs terminated with 50Ω to ground when $V_{CCOx} = 1.8V \pm 5\%$.

c. Qx denotes QA0, QA1, QA2, QA3, QB0, QB1, QB2, QB3. nQx denotes nQA0, nQA1, nQA2, nQA3, nQB0, nQB1, nQB2, nQB3.

Table 18: LVDS DC Characteristics, $V_{CC} = 3.3V \pm 5\%$, $2.5V \pm 5\%$ or $1.8V \pm 5\%$, $V_{CCOA} = V_{CCOB} = 3.3V \pm 5\%$, $2.5V \pm 5\%$ or $1.8V \pm 5\%$, $T_A = -40^\circ C$ to $+85^\circ C$

Symbol	Parameter		Test Conditions	Minimum	Typical	Maximum	Units
V_{OD}	Differential output voltage	$Qx, nQx^{[a]}$	Terminated 100Ω across Qx and nQx	247		480	mV
ΔV_{OD}	V_{OD} magnitude change	$Qx, nQx^{[a]}$		50			mV
V_{OS}	Offset voltage	$Qx, nQx^{[a]}$		1.125		1.375	V
ΔV_{OS}	V_{OS} magnitude change	$Qx, nQx^{[a]}$				50	mV

a. Qx denotes QA0, QA1, QA2, QA3, QB0, QB1, QB2, QB3. nQx denotes nQA0, nQA1, nQA2, nQA3, nQB0, nQB1, nQB2, nQB3.

Table 19: CML (400mV Swing) DC Characteristics, $V_{CC} = 3.3V \pm 5\%$, $2.5V \pm 5\%$ or $1.8V \pm 5\%$, $V_{CCOA} = V_{CCOB} = 3.3V \pm 5\%$, $2.5V \pm 5\%$ or $1.8V \pm 5\%$, $T_A = -40^\circ C$ to $+85^\circ C$

Symbol	Parameter		Test Conditions	Minimum	Typical	Maximum	Units
V_{OH}	Output high voltage	$Qx, nQx^{[a]}$	Terminated with 50Ω to $V_{CCOx}^{[b]}$	$V_{CCOx}^{[b]} - 0.10$		$V_{CCOx}^{[b]}$	V
V_{OL}	Output low voltage	$Qx, nQx^{[a]}$		$V_{CCOx}^{[b]} - 0.50$		$V_{CCOx}^{[b]} - 0.30$	V
V_{OUT}	Output voltage swing	$Qx, nQx^{[a]}$		300		500	mV

a. Qx denotes QA0, QA1, QA2, QA3, QB0, QB1, QB2, QB3. nQx denotes nQA0, nQA1, nQA2, nQA3, nQB0, nQB1, nQB2, nQB3.

b. V_{CCOx} denotes V_{CCOA} and V_{CCOB} .

Table 20: CML (800mV Swing) DC Characteristics, $V_{CC} = 3.3V \pm 5\%$, $2.5V \pm 5\%$ or $1.8V \pm 5\%$, $V_{CCOA} = V_{CCOB} = 3.3V \pm 5\%$, $2.5V \pm 5\%$ or $1.8V \pm 5\%$, $T_A = -40^\circ C$ to $+85^\circ C$

Symbol	Parameter		Test Conditions	Minimum	Typical	Maximum	Units
V_{OH}	Output high voltage	$Qx, nQx^{[a]}$	Terminated with 50Ω to $V_{CCOx}^{[b]}$	$V_{CCOx}^{[b]} - 0.10$		V_{CCOx}	V
V_{OL}	Output low voltage	$Qx, nQx^{[a]}$		$V_{CCOx}^{[b]} - 0.95$		$V_{CCOx}^{[b]} - 0.70$	V
V_{OUT}	Output voltage swing	$Qx, nQx^{[a]}$		575		1000	mV

a. Qx denotes QA0, QA1, QA2, QA3, QB0, QB1, QB2, QB3. nQx denotes nQA0, nQA1, nQA2, nQA3, nQB0, nQB1, nQB2, nQB3.

b. V_{CCOx} denotes V_{CCOA} and V_{CCOB} .

Table 21: LVCMOS Clock Outputs DC Characteristics, $V_{CC} = 3.3V \pm 5\%$, $2.5V \pm 5\%$ or $1.8V \pm 5\%$, $V_{EE} = 0V$, $T_A = -40^\circ C$ to $+85^\circ C$

Symbol	Parameter	Test Conditions	$V_{CCOA} = 3.3V \pm 5\%$			$V_{CCOA} = 2.5V \pm 5\%$			$V_{CCOA} = 1.8V \pm 5\%$			$V_{CCOA} = 1.5V \pm 5\%$			Units
			Min	Typ	Max	Min	Typ	Max	Min	Typ	Max	Min	Typ	Max	
V_{OH}	Output high voltage QAx, nQAx ^[a]	$I_{OH} = -8mA$	2.6			1.1			1.1			1.1			V
V_{OL}	Output low voltage QAx, nQAx ^[a]	$I_{OL} = 8mA$			0.5			0.5			0.5			0.5	V

a. QAm denotes QA0, QA1, QA2, QA3. nQAm denotes nQA0, nQA1, nQA2, nQA3.

Table 22: Input Frequency Characteristics, $V_{CC} = 3.3V \pm 5\%$, $2.5V \pm 5\%$ or $1.8V \pm 5\%$, $T_A = -40^\circ C$ to $+85^\circ C$

Symbol	Parameter		Test Conditions	Minimum	Typical	Maximum	Units
f_{IN}	Input frequency, CLKx, nCLKx	LVPECL, LVDS, HCSL, CML		1PPS		700MHz	
		LVCMOS		1PPS		200MHz	
idc	Input duty cycle ^[a]				50		%
f_{SCLK}	Serial port clock SCLK	I ² C operation		100		400	kHz
		SPI operation				50	MHz

a. Any deviation from a 50% duty cycle on the input may be reflected in the output duty cycle.

AC Electrical Characteristics

Table 23: AC Characteristics, $V_{CC} = 3.3V \pm 5\%$, $2.5V \pm 5\%$ or $1.8V \pm 5\%$,
 $V_{CCOA} = V_{CCOB} = 3.3V \pm 5\%$, $2.5V \pm 5\%$ or $1.8V \pm 5\%$, $T_A = -40^\circ C$ to $+85^\circ C$

Symbol	Parameter ^[a]		Test Conditions		Minimum	Typical	Maximum	Units
f_{OUT}	Output frequency	LVPECL, LVDS			1PPS		700MHz	
		HCSL, CML ^[b]						
		LVC MOS			1PPS		200MHz	
t_R / t_F	Output rise and fall times	LVPECL	20% to 80%		125		700	ps
		LVDS	$V_{CCOx}^{[c]} = 3.3V$	20% to 80%	125		550	ps
			$V_{CCOx}^{[c]} = 2.5V$	20% to 80%				
			$V_{CCOx}^{[c]} = 1.8V$	20% to 80%	175		550	ps
		CML, 400mV	20% to 80%		100		675	ps
		CML, 800mV	20% to 80%		125		825	ps
		LVC MOS	$V_{CCOA} = 3.3V$	20% to 80%	200		800	ps
			$V_{CCOA} = 2.5V$	20% to 80%				
$V_{CCOA} = 1.8V$	20% to 80%							
$V_{CCOA} = 1.5V$	20% to 80%			650	1300	ps		
$t_{sk}(b)$	Bank skew ^{[d], [e], [f]}	LVPECL				15	50	ps
		LVDS				20	60	ps
		CML				10	35	ps
		HCSL				10	35	ps
		LVC MOS				50	100	ps
odc	Output duty cycle ^[g]	LVPECL, LVDS, HCSL, CML	Even divide ratios		45	50	55	%
		LVPECL, LVDS, HCSL, CML	Odd divide ratios / bypass		43	50	57	%
		LVC MOS	$V_{CCOA} = 3.3V, 2.5V, \text{ or } 1.8V$	Even divide ratios	45	50	55	%
				Odd divide ratios / bypass	40	50	60	%
		LVC MOS	$V_{CCOA} = 1.5V$	Even divide ratios	40	50	60	%
				Odd divide ratios / bypass	38	50	62	%
MUX_{ISOL}	Mux isolation	156.25MHz, $V_{SWING} = 800mV$			61		dB	
	Noise floor	Offset >10MHz from 156.25MHz carrier			-154		dBc/Hz	

- a. Electrical parameters are guaranteed over the specified ambient operating temperature range, which is established when the device is mounted in a test socket with maintained transverse airflow greater than 500lpm. The device will meet specifications after thermal equilibrium has been reached under these conditions.
- b. CML denotes CML 400mV and CML 800mV, unless otherwise stated.
- c. V_{CCOx} denotes V_{CCOA} and V_{CCOB} .

- d. This parameter is guaranteed by characterization. Not tested in production.
- e. This parameter is defined in accordance with JEDEC Standard 65.
- f. Defined as skew within a bank of outputs at the same supply voltage and with equal load conditions.
- g. Measured using 50% duty cycle on input reference.

Table 24: HCSL AC Characteristics, $V_{CC} = 3.3V \pm 5\%$, $2.5V \pm 5\%$ or $1.8V \pm 5\%$,
 $V_{CCOA} = V_{CCOB} = 3.3V \pm 5\%$, $2.5V \pm 5\%$ or $1.8V \pm 5\%$, $T_A = -40^\circ C$ to $+85^\circ C$

Symbol	Parameter ^[a]	Test Conditions ^[b]	Minimum	Typical	Maximum	Units
t_{SLEW}	Rise/ fall edge rate ^[c]	$V_{CCOx} = 3.3V$ or $2.5V$	0.6		4	V/ns
		$V_{CCOx} = 1.8V$	0.45		4	V/ns
V_{MAX}	Absolute max. output voltage ^{[d], [e]}	$V_{CCOx} = 3.3V, 2.5V, 1.8V$			1150	mV
V_{MIN}	Absolute min. output voltage ^{[d], [f]}	$V_{CCOx} = 3.3V, 2.5V, 1.8V$	-150			mV
V_{CROSS}	Absolute crossing voltage ^{[g], [h]}	$V_{CCOx} = 3.3V, 2.5V, 1.8V$			550	mV
ΔV_{CROSS}	Total variation of V_{CROSS} over all edges ^{[g], [i]}	$V_{CCOx} = 3.3V, 2.5V, 1.8V$			140	mV

- a. Electrical parameters are guaranteed over the specified ambient operating temperature range, which is established when the device is mounted in a test socket with maintained transverse airflow greater than 500lfpm. The device will meet specifications after thermal equilibrium has been reached under these conditions.
- b. V_{CCOx} denotes V_{CCOA} and V_{CCOB} .
- c. Measured from $-150mV$ to $+150mV$ on the differential waveform (derived from Qx minus nQx). The signal must be monotonic through the measurement region for rise and fall time. The 300mV measurement window is centered on the differential zero crossing.
- d. Measurement taken from single ended waveform.
- e. Defined as the maximum instantaneous voltage including overshoot.
- f. Defined as the minimum instantaneous voltage including undershoot.
- g. Measured at crossing point where the instantaneous voltage value of the rising edge of Qm equals the falling edge of nQm .
- h. Refers to the total variation from the lowest crossing point to the highest, regardless of which edge is crossing. Refers to all crossing points for this measurement.
- i. Defined as the total variation of all crossing voltages of rising Qm and falling nQm , This is the maximum allowed variance in V_{CROSS} for any particular system.

Table 25: Additive Jitter, $V_{CC} = 3.3V, 2.5V$ or $1.8V$, $V_{CCOA} = V_{CCOB} = 3.3V, 2.5V, 1.8V$ or $1.5V$ (1.5V only supported for LVCMOS outputs), $T_A = 25^\circ C$

Symbol	Parameter		Test Conditions ^[a]		Minimum	Typical	Maximum	Units
$t_{jit}(f)$	RMS additive jitter (random); Integration range: 12kHz – 20MHz	LVPECL	$f_{OUT} = 156.25MHz$	$V_{CCOx}^{[b]} = 3.3V$ or $2.5V$		77	92	fs
				$V_{CCOx}^{[b]} = 1.8V$		90	117	fs
			$f_{OUT} = 625MHz$	$V_{CCOx}^{[b]} = 3.3V$ or $2.5V$		50	60	fs
				$V_{CCOx}^{[b]} = 1.8V$		60	84	fs
		LVDS	$f_{OUT} = 156.25MHz$	$V_{CCOx}^{[b]} = 3.3V$ or $2.5V$		85	104	fs
				$V_{CCOx}^{[b]} = 1.8V$		126	185	fs
			$f_{OUT} = 625MHz$	$V_{CCOx}^{[b]} = 3.3V$ or $2.5V$		48	61	fs
				$V_{CCOx}^{[b]} = 1.8V$		57	84	fs
		HCSL	$f_{OUT} = 156.25MHz$	$V_{CCOx}^{[b]} = 3.3V$ or $2.5V$		92	132	fs
				$V_{CCOx}^{[b]} = 1.8V$		92	133	fs
			$f_{OUT} = 625MHz$	$V_{CCOx}^{[b]} = 3.3V$ or $2.5V$		61	73	fs
				$V_{CCOx}^{[b]} = 1.8V$		67	93	fs
LVCMOS	$f_{OUT} = 156.25MHz$	$V_{CCOA} = 3.3V$ or $2.5V$		98	166	fs		
		$V_{CCOA} = 1.8V$		128	204	fs		
		$V_{CCOA} = 1.5V$		198	314	fs		

a. All outputs configured for the specific output type, as shown in the table.

b. V_{CCOx} denotes V_{CCOA} and V_{CCOB} .

Applications Information

Recommendations for Unused Input and Output Pins

Inputs:

CLK/nCLK Inputs

For applications not requiring the use of the differential input, both CLK and nCLK can be left floating. Though not required, but for additional protection, a 1k Ω resistor can be tied from CLK to ground.

LVC MOS Control Pins

All control pins have internal pullups and pulldowns; additional resistance is not required but can be added for additional protection. A 1k Ω resistor can be used.

Outputs:

LVC MOS Outputs

All unused LVC MOS outputs can be left floating. It is recommended that there is no trace attached.

LVPECL Outputs

All unused LVPECL outputs can be left floating. We recommend that there is no trace attached. Both sides of the differential output pair should either be left floating or terminated.

LVDS Outputs

All unused LVDS output pairs can be either left floating or terminated with 100 Ω across. If they are left floating, there should be no trace attached.

Differential Outputs

All unused Differential outputs can be left floating. It is recommended that there is no trace attached.

Power Dissipation and Thermal Considerations

The 8P79818 is a multi-functional, high speed device that targets a wide variety of clock frequencies and applications. Since this device is highly programmable with a broad range of features and functionality, the power consumption will vary as each of these features and functions is enabled.

The 8P79818 device was designed and characterized to operate within the ambient industrial temperature range of -40°C to +85°C. The ambient temperature represents the temperature around the device, not the junction temperature. When using the device in extreme cases, such as maximum operating frequency and high ambient temperature, external air flow may be required in order to ensure a safe and reliable junction temperature. Extreme care must be taken to avoid exceeding 125°C junction temperature.

The power calculation examples below were generated using a maximum ambient temperature and supply voltage. For many applications, the power consumption will be much lower. Please contact IDT technical support for any concerns on calculating the power dissipation for your own specific configuration.

Power Domains

The 8P79818 device has a number of separate power domains that can be independently enabled and disabled via register accesses (all power supply pins must still be connected to a valid supply voltage). Figure 7 below indicates the individual domains and the associated power pins.

Figure 7: 8P79818 Power Domains

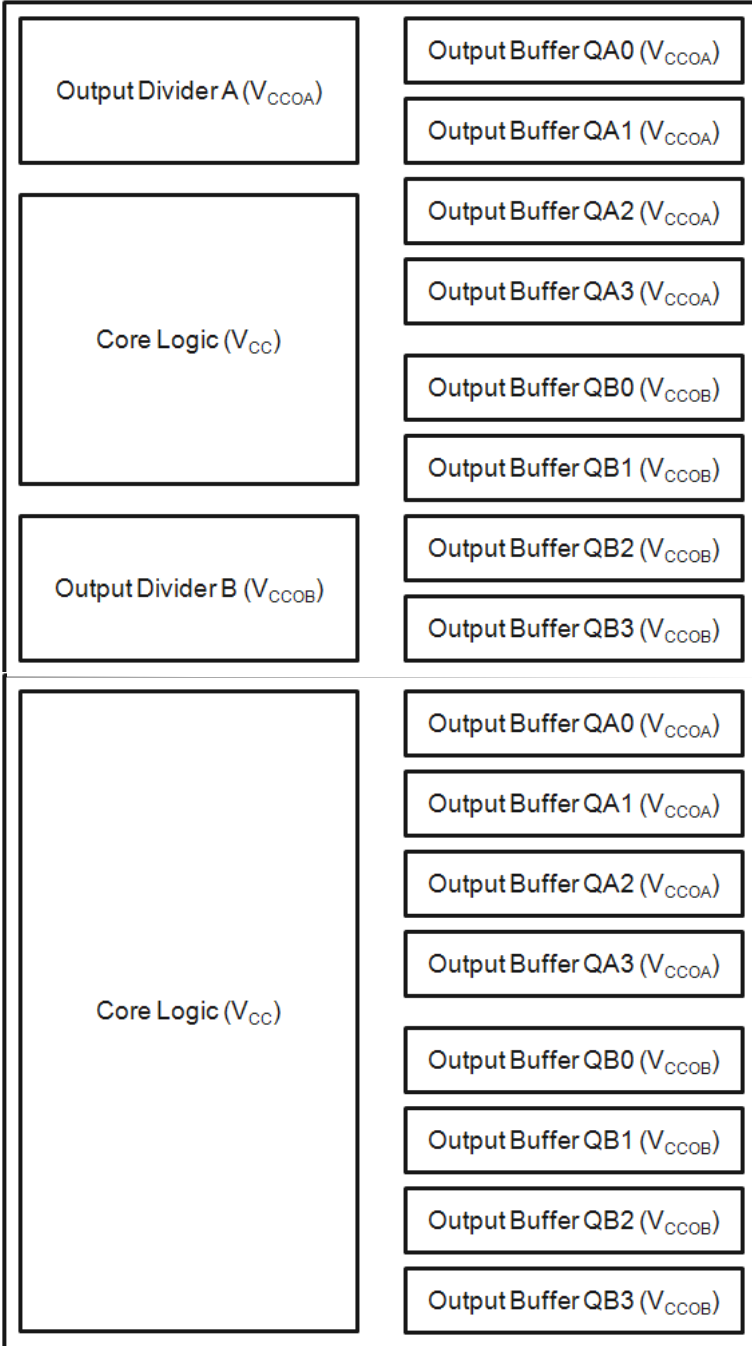

Power Consumption Calculation

Determining total power consumption involves several steps:

1. Determine the power consumption using maximum current values for core voltage from [Table 11](#), [Table 12](#) and [Table 13, Page 18](#) for the appropriate case of how many dividers are enabled.
2. Determine the nominal power consumption of each enabled output path.
 - a. This consists of a base amount of power that is independent of operating frequency, as shown in [Table 27](#) through [Table 43](#) (depending on the chosen output protocol).
 - b. Then there is a variable amount of power that is related to the output frequency. This can be determined by multiplying the output frequency by the FQ_Factor shown in [Table 27](#) through [Table 43](#).
3. All of the above totals are then summed.

Example Calculations

Table 26: Example 1. Common Customer Configuration (3.3V Core Voltage)

Bank	Configuration	Frequency (MHz)	V _{CC0}
Bank A	LVDS	125	3.3V
Bank B	LVDS	125	2.5V

- Core supply current, I_{CC} = 24.7mA (max.)
- Output supply current, Bank A = 0.06 * 125 + 71.615 = 79.115mA
- Output supply current, Bank B = 0.06 * 125 + 71.615 = 79.115mA
- Total device current = 24.7mA + 79.115mA + 79.115mA = 182.93mA
- Total device power = 3.465V * 182.93mA = 633.934mW

With an ambient temperature of 85°C and no airflow, the junction temperature is:

$$T_J = 85^\circ\text{C} + 35.23^\circ\text{C/W} * 0.634\text{W} = 107.3^\circ\text{C}$$

Thermal Considerations

Once the total power consumption has been determined, it is necessary to calculate the maximum operating junction temperature for the device under the environmental conditions it will operate in. Thermal conduction paths, air flow rate and ambient air temperature are factors that can affect this. The thermal conduction path refers to whether heat is to be conducted away via a heat-sink, via airflow or via conduction into the PCB through the device pads (including the ePAD). Thermal conduction data is provided for typical scenarios in [Table 44, Page 30](#). Please contact IDT for assistance in calculating results under other scenarios.

Current Consumption Data and Equations

Table 27: 3.3V LVDS Output Calculation Table

LVDS	FQ_Factor (mA/MHz), per output	Base_Current (mA)
Qx, nQx ^[a]	0.06	71.615

- a. Qx denotes QA0, QA1, QA2, QA3, QB0, QB1, QB2, QB3.
nQx denotes nQA0, nQA1, nQA2, nQA3, nQB0, nQB1, nQB2, nQB3.

Table 28: 2.5V LVDS Output Calculation Table

LVDS	FQ_Factor (mA/MHz), per output	Base_Current (mA)
Qx, nQx ^[a]	0.06	71.544

- a. Qx denotes QA0, QA1, QA2, QA3, QB0, QB1, QB2, QB3.
nQx denotes nQA0, nQA1, nQA2, nQA3, nQB0, nQB1, nQB2, nQB3.

Table 29: 1.8V LVDS Output Calculation Table

LVDS	FQ_Factor (mA/MHz), per output	Base_Current (mA)
Qx, nQx ^[a]	0.1	50.284

- a. Qx denotes QA0, QA1, QA2, QA3, QB0, QB1, QB2, QB3.
nQx denotes nQA0, nQA1, nQA2, nQA3, nQB0, nQB1, nQB2, nQB3.

Table 30: 3.3V LVPECL Output Calculation Table

LVPECL	FQ_Factor (mA/MHz), per output	Base_Current (mA)
Qx, nQx ^[a]	0.05	53.475

- a. Qx denotes QA0, QA1, QA2, QA3, QB0, QB1, QB2, QB3.
nQx denotes nQA0, nQA1, nQA2, nQA3, nQB0, nQB1, nQB2, nQB3.

Table 31: 2.5V LVPECL Output Calculation Table

LVPECL	FQ_Factor (mA/MHz), per output	Base_Current (mA)
Qx, nQx ^[a]	0.04	20.874

- a. Qx denotes QA0, QA1, QA2, QA3, QB0, QB1, QB2, QB3.
nQx denotes nQA0, nQA1, nQA2, nQA3, nQB0, nQB1, nQB2, nQB3.

Table 32: 1.8V LVPECL Output Calculation Table

LVPECL	FQ_Factor (mA/MHz), per output	Base_Current (mA)
Qx, nQx ^[a]	0.04	19.962

- a. Qx denotes QA0, QA1, QA2, QA3, QB0, QB1, QB2, QB3.
nQx denotes nQA0, nQA1, nQA2, nQA3, nQB0, nQB1, nQB2, nQB3.

Table 33: 3.3V HCSL Output Calculation Table

HCSL	FQ_Factor (mA/MHz), per output	Base_Current (mA)
Qx, nQx ^[a]	0.05	54.911

- a. Qx denotes QA0, QA1, QA2, QA3, QB0, QB1, QB2, QB3.
nQx denotes nQA0, nQA1, nQA2, nQA3, nQB0, nQB1, nQB2, nQB3.

Table 34: 3.3V CML Output (400mV) Calculation Table

CML	FQ_Factor (mA/MHz), per output	Base_Current (mA)
Qx, nQx ^[a]	0.03	51.889

- a. Qx denotes QA0, QA1, QA2, QA3, QB0, QB1, QB2, QB3.
nQx denotes nQA0, nQA1, nQA2, nQA3, nQB0, nQB1, nQB2, nQB3.

Table 35: 2.5V CML Output (400mV) Calculation Table

CML	FQ_Factor (mA/MHz), per output	Base_Current (mA)
Qx, nQx ^[a]	0.02	49.220

- a. Qx denotes QA0, QA1, QA2, QA3, QB0, QB1, QB2, QB3.
nQx denotes nQA0, nQA1, nQA2, nQA3, nQB0, nQB1, nQB2, nQB3.

Table 36: 1.8V CML Output (400mV) Calculation Table

CML	FQ_Factor (mA/MHz), per output	Base_Current (mA)
Qx, nQx ^[a]	0.02	47.326

- a. Qx denotes QA0, QA1, QA2, QA3, QB0, QB1, QB2, QB3.
nQx denotes nQA0, nQA1, nQA2, nQA3, nQB0, nQB1, nQB2, nQB3.

Table 37: 3.3V CML Output (800mV) Calculation Table

CML	FQ_Factor (mA/MHz), per output	Base_Current (mA)
Qx, nQx ^[a]	0.02	51.474

- a. Qx denotes QA0, QA1, QA2, QA3, QB0, QB1, QB2, QB3.
nQx denotes nQA0, nQA1, nQA2, nQA3, nQB0, nQB1, nQB2, nQB3.

Table 38: 2.5V CML Output (800mV) Calculation Table

CML	FQ_Factor (mA/MHz), per output	Base_Current (mA)
Qx, nQx ^[a]	0.02	48.906

- a. Qx denotes QA0, QA1, QA2, QA3, QB0, QB1, QB2, QB3.
nQx denotes nQA0, nQA1, nQA2, nQA3, nQB0, nQB1, nQB2, nQB3.

Table 39: 1.8V CML Output (800mV) Calculation Table

CML	FQ_Factor (mA/MHz), per output	Base_Current (mA)
Qx, nQx ^[a]	0.02	47.334

- a. Qx denotes QA0, QA1, QA2, QA3, QB0, QB1, QB2, QB3.
nQx denotes nQA0, nQA1, nQA2, nQA3, nQB0, nQB1, nQB2, nQB3.

Table 40: 3.3V LVCMOS Output Calculation Table

LVCMOS	Base_Current (mA)
Qx, nQx ^[a]	62.289

- a. Qx denotes QA0, QA1, QA2, QA3, QB0, QB1, QB2, QB3.
nQx denotes nQA0, nQA1, nQA2, nQA3, nQB0, nQB1, nQB2, nQB3.

Table 41: 2.5V LVCMOS Output Calculation Table

LVCMOS	Base_Current (mA)
Qx, nQx ^[a]	51.097

- a. Qx denotes QA0, QA1, QA2, QA3, QB0, QB1, QB2, QB3.
nQx denotes nQA0, nQA1, nQA2, nQA3, nQB0, nQB1, nQB2, nQB3.

Table 42: 1.8V LVCMOS Output Calculation Table

LVCMOS	Base_Current (mA)
Qx, nQx ^[a]	47.745

- a. Qx denotes QA0, QA1, QA2, QA3, QB0, QB1, QB2, QB3.
nQx denotes nQA0, nQA1, nQA2, nQA3, nQB0, nQB1, nQB2, nQB3.

Table 43: 1.5V LVCMOS Output Calculation Table

LVCMOS	Base_Current (mA)
Qx, nQx ^[a]	41.485

- a. Qx denotes QA0, QA1, QA2, QA3, QB0, QB1, QB2, QB3.
nQx denotes nQA0, nQA1, nQA2, nQA3, nQB0, nQB1, nQB2, nQB3.

Applying the values to the following equation will yield output current by frequency: (mA) = FQ_Factor * Frequency (MHz) + Base_Current
 where:

Qx Current is the specific output current according to output type and frequency

FQ_Factor is used for calculating current increase due to output frequency

Base_Current is the base current for each output path independent of output frequency

The second step is to multiply the power dissipated by the thermal impedance to determine the maximum power gradient, using the following equation:

$$T_J = T_A + (\theta_{JA} * Pd_{total})$$

where:

T_J is the junction temperature (°C)

T_A is the ambient temperature (°C)

θ_{JA} is the thermal resistance value from [Table 44, Page 30](#), dependent on ambient airflow (°C/W)

Pd_{total} is the total power dissipation of the 8P79818 under usage conditions, including power dissipated due to loading (W)

Note that for LVPECL outputs the power dissipation through the load is assumed to be 27.95mW. When selecting LVCMOS outputs, power dissipation through the load will vary based on a variety of factors including termination type and trace length. For these examples, power dissipation through loading will be calculated using C_{PD} (found in [Table 10, Page 16](#)) and output frequency:

$$Pd_{OUT} = C_{PD} * f_{OUT} * V_{CCO}^2$$

where:

Pd_{out} is the power dissipation of the output (W)

C_{PD} is the power dissipation capacitance (pF)

f_{OUT} is the output frequency of the selected output (MHz)

V_{CCO} is the voltage supplied to the appropriate output (V)

Table 44: θ_{JA} vs. Air Flow Table for a 32-lead 5mm x 5mm VFQFN

θ_{JA} vs. Air Flow			
Meters per Second	0	1	2
Multi-Layer PCB, JEDEC Standard Test Boards	35.23°C/W	31.6°C/W	30.0°C/W

Figure 9: Package Drawings (Continued)

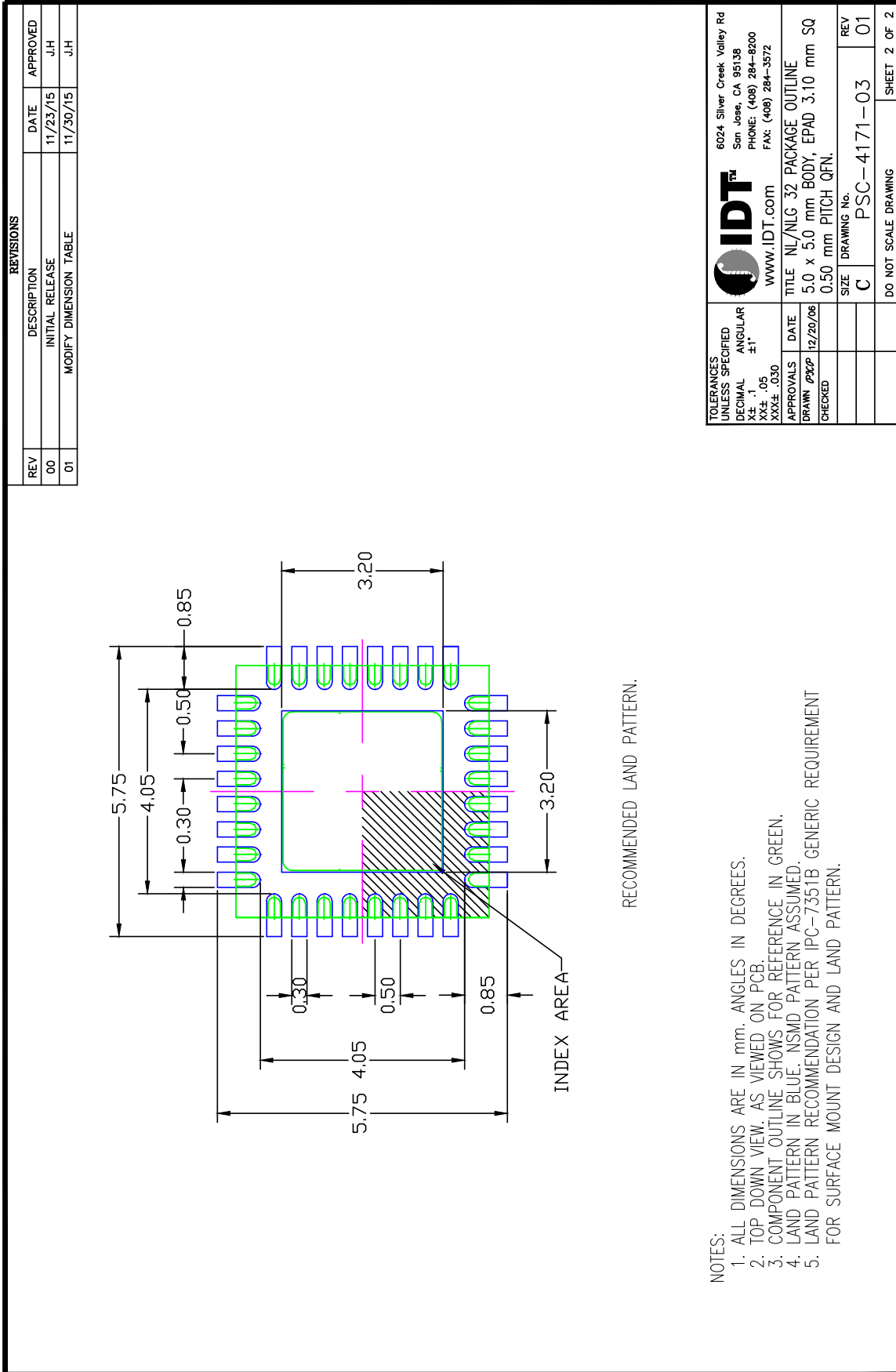

Marking Diagram

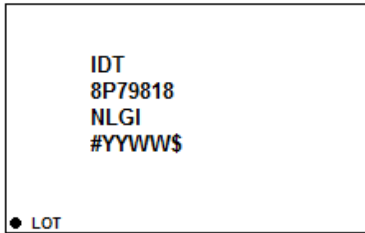

1. Line 1 is the prefix of the part number.
2. Line 2 and Line 3 is the part number.
3. Line 4 "YYWW\$"
 - a. "YY" are the last digits of the year and "WW" is the work week that the part was assembled.
 - b. "\$" denotes mark code.

Ordering Information

Table 45: Ordering Information

Part/Order Number	Marking	Package	Shipping Packaging	Temperature
8P79818NLGI	IDT8P79818NLGI	32-lead VFQFN, Lead Free	Tray	-40°C to +85°C
8P79818NLGI8	IDT8P79818NLGI	32-lead VFQFN, Lead Free	Tape & Reel	-40°C to +85°C
8P79818NLGI/W	IDT8P79818NLGI	32-lead VFQFN, Lead Free	Tape & Reel	-40°C to +85°C

Table 46: Pin 1 Orientation in Tape and Reel Packaging

Part Number Suffix	Pin 1 Orientation	Illustration
NLGI8	Quadrant 1 (EIA-481-C)	
NLGI/W	Quadrant 2 (EIA-481-D)	

Revision History

Revision Date	Description of Change
December 19, 2016	Initial datasheet.

IMPORTANT NOTICE AND DISCLAIMER

RENESAS ELECTRONICS CORPORATION AND ITS SUBSIDIARIES (“RENESAS”) PROVIDES TECHNICAL SPECIFICATIONS AND RELIABILITY DATA (INCLUDING DATASHEETS), DESIGN RESOURCES (INCLUDING REFERENCE DESIGNS), APPLICATION OR OTHER DESIGN ADVICE, WEB TOOLS, SAFETY INFORMATION, AND OTHER RESOURCES “AS IS” AND WITH ALL FAULTS, AND DISCLAIMS ALL WARRANTIES, EXPRESS OR IMPLIED, INCLUDING, WITHOUT LIMITATION, ANY IMPLIED WARRANTIES OF MERCHANTABILITY, FITNESS FOR A PARTICULAR PURPOSE, OR NON-INFRINGEMENT OF THIRD PARTY INTELLECTUAL PROPERTY RIGHTS.

These resources are intended for developers skilled in the art designing with Renesas products. You are solely responsible for (1) selecting the appropriate products for your application, (2) designing, validating, and testing your application, and (3) ensuring your application meets applicable standards, and any other safety, security, or other requirements. These resources are subject to change without notice. Renesas grants you permission to use these resources only for development of an application that uses Renesas products. Other reproduction or use of these resources is strictly prohibited. No license is granted to any other Renesas intellectual property or to any third party intellectual property. Renesas disclaims responsibility for, and you will fully indemnify Renesas and its representatives against, any claims, damages, costs, losses, or liabilities arising out of your use of these resources. Renesas' products are provided only subject to Renesas' Terms and Conditions of Sale or other applicable terms agreed to in writing. No use of any Renesas resources expands or otherwise alters any applicable warranties or warranty disclaimers for these products.

(Rev.1.0 Mar 2020)

Corporate Headquarters

TOYOSU FORESIA, 3-2-24 Toyosu,
Koto-ku, Tokyo 135-0061, Japan
www.renesas.com

Contact Information

For further information on a product, technology, the most up-to-date version of a document, or your nearest sales office, please visit:
www.renesas.com/contact/

Trademarks

Renesas and the Renesas logo are trademarks of Renesas Electronics Corporation. All trademarks and registered trademarks are the property of their respective owners.