

ZMM55-B2V4 SERIES

SURFACE MOUNT ZENER DIODES

VOLTAGE 2.4 to 100 Volts

POWER 500 mWatts

MINI-MELF / LL34

Unit : inch(mm)

FEATURES

- Planar Die construction
- 500mW Power Dissipation
- Ideally Suited for Automated Assembly Processes
- Lead free in comply with EU RoHS 2011/65/EU directives

MECHANICAL DATA

- Case: Molded Glass MINI-MELF
- Terminals: Solderable per MIL-STD-750, Method 2026
- Polarity: See Diagram Below
- Approx. Weight: 0.03 grams
- Mounting Position: Any
- Packing information

T/R - 2.5K per 7" plastic Reel

T/R - 10K per 13" plastic Reel

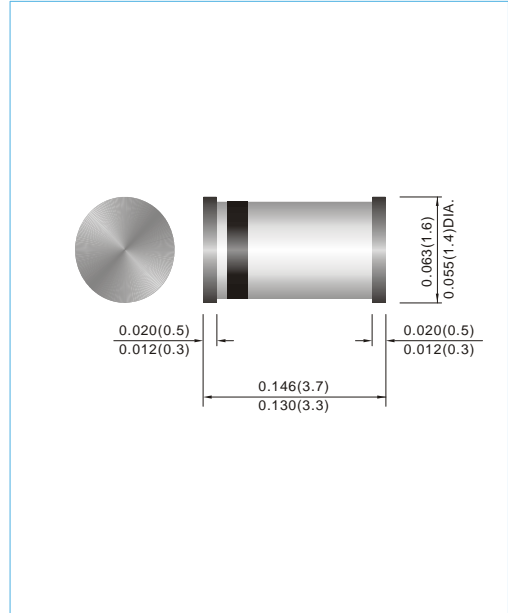
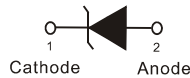
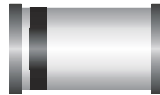

MAXIMUM RATINGS AND ELECTRICAL CHARACTERISTICS

Parameter	Symbol	Value	Units
Power Dissipation at Tamb = 25 °C	P _{TOT}	500	mW
Junction Temperature	T _J	175	°C
Storage Temperature Range	T _S	-65 to +175	°C

Valid provided that leads at a distance of 8mm from case are kept at ambient temperature.

Parameter	Symbol	Min.	Typ.	Max.	Units
Thermal Resistance Junction to Ambient Air	R _{θJA}	--	--	0.3	K/mW
Forward Voltage at I _F = 200mA	V _F	--	--	1.5	V

ZMM55-B2V4 SERIES

Part Number	Nominal Zener Voltage			Max. Zener Impedance				Max Reverse Leakage Current		Marking code
	V _Z @ I _{ZT}			Z _{ZT} @ I _{ZT}		Z _{ZK} @ I _{ZK}		I _R @ V _R		
	Nom. V	Min. V	Max. V	Ω	mA	Ω	mA	μA	V	
ZMM55-B2V4	2.4	2.35	2.45	85	5	600	1	50	1	B2V4
ZMM55-B2V7	2.7	2.65	2.75	85	5	600	1	10	1	B2V7
ZMM55-B3V0	3	2.94	3.06	85	5	600	1	4	1	B3V0
ZMM55-B3V3	3.3	3.23	3.37	85	5	600	1	2	1	B3V3
ZMM55-B3V6	3.6	3.53	3.67	85	5	600	1	2	1	B3V6
ZMM55-B3V9	3.9	3.82	3.98	85	5	600	1	2	1	B3V9
ZMM55-B4V3	4.3	4.21	4.39	75	5	600	1	1	1	B4V3
ZMM55-B4V7	4.7	4.61	4.79	60	5	600	1	0.5	1	B4V7
ZMM55-B5V1	5.1	5	5.2	35	5	550	1	0.1	1	B5V1
ZMM55-B5V6	5.6	5.49	5.71	25	5	450	1	0.1	1	B5V6
ZMM55-B6V2	6.2	6.08	6.32	10	5	200	1	0.1	2	B6V2
ZMM55-B6V8	6.8	6.66	6.94	8	5	150	1	0.1	3	B6V8
ZMM55-B7V5	7.5	7.35	7.65	7	5	50	1	0.1	5	B7V5
ZMM55-B8V2	8.2	8.04	8.36	7	5	50	1	0.1	6	B8V2
ZMM55-B9V1	9.1	8.92	9.28	10	5	50	1	0.1	7	B9V1
ZMM55-B10	10	9.8	10.2	15	5	70	1	0.1	7.5	B10V
ZMM55-B11	11	10.78	11.22	20	5	70	1	0.1	8.5	B11V
ZMM55-B12	12	11.76	12.24	20	5	90	1	0.1	9	B12V
ZMM55-B13	13	12.74	13.26	26	5	110	1	0.1	10	B13V
ZMM55-B15	15	14.7	15.3	30	5	110	1	0.1	11	B15V
ZMM55-B16	16	15.68	16.32	40	5	170	1	0.1	12	B16V
ZMM55-B18	18	17.64	18.36	50	5	170	1	0.1	14	B18V
ZMM55-B20	20	19.6	20.4	55	5	220	1	0.1	15	B20V
ZMM55-B22	22	21.56	22.44	55	5	220	1	0.1	17	B22V
ZMM55-B24	24	23.52	24.48	80	5	220	1	0.1	18	B24V
ZMM55-B27	27	26.46	27.54	80	5	220	1	0.1	20	B27V
ZMM55-B30	30	29.4	30.6	80	5	220	1	0.1	22	B30V
ZMM55-B33	33	32.34	33.66	80	5	220	1	0.1	24	B33V
ZMM55-B36	36	35.28	36.72	80	5	220	1	0.1	27	B36V
ZMM55-B39	39	38.22	39.78	90	2.5	500	1	0.1	30	B39V
ZMM55-B43	43	42.14	43.86	90	2.5	600	1	0.1	33	B43V
ZMM55-B47	47	46.06	47.94	110	2.5	700	1	0.1	36	B47V
ZMM55-B51	51	49.98	52.02	125	2.5	700	0.5	0.1	39	B51V
ZMM55-B56	56	54.88	57.12	135	2.5	1000	0.5	0.1	43	B56V
ZMM55-B62	62	60.76	63.24	150	2.5	1000	0.5	0.1	47	B62V
ZMM55-B68	68	65.66	68.34	200	2.5	1000	0.5	0.1	51	B68V
ZMM55-B75	75	73.5	76.5	250	2.5	1500	0.5	0.1	56	B75V
ZMM55-B82	82	80.36	83.64	300	2.5	2000	0.5	0.1	62	B82V
ZMM55-B91	91	89.18	92.82	450	1	5000	0.1	0.1	68	B91V
ZMM55-B100	100	98	102	450	1	5000	0.1	0.1	75	B100

Notes.

- STANDARD VOLTAGE TOLERANCE IS + 5% AND :
- SUFFIX "A" FOR + 1%
- SUFFIX "B" FOR + 2%
- SUFFIX "C" FOR + 5%
- SUFFIX "D" FOR + 20%

ZMM55-B2V4 SERIES

Typical Characteristics ($T_{amb} = 25\text{ }^{\circ}\text{C}$ unless otherwise specified)

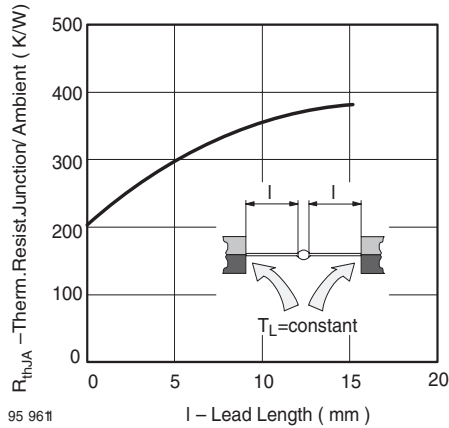

Fig. 1 Thermal Resistance vs. Lead Length

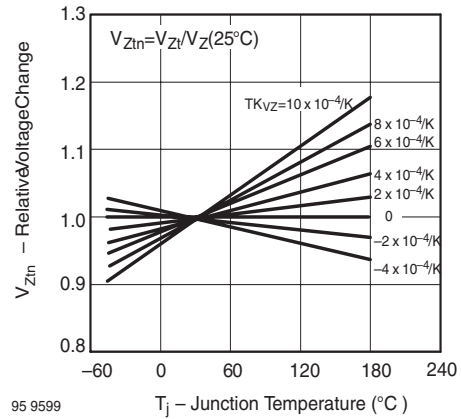

Fig. 4 Typical Change of Working Voltage vs. Junction Temperature

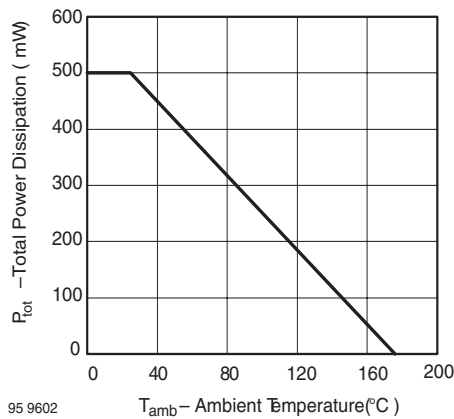

Fig. 2 Total Power Dissipation vs. Ambient Temperature

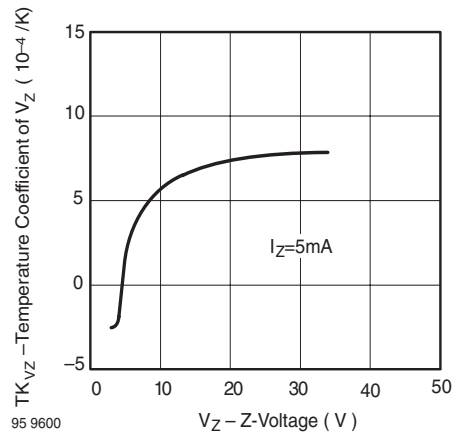

Fig. 5 Temperature Coefficient of V_Z vs. Z-Voltage

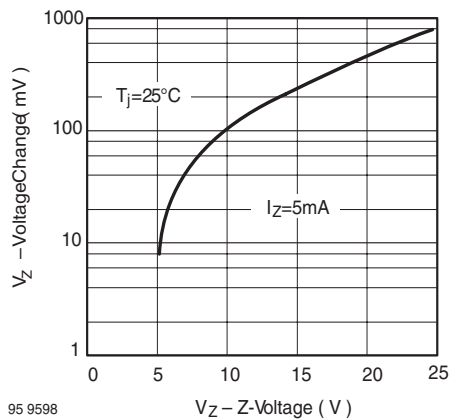

Fig. 3 Typical Change of Working Voltage under Operating Conditions at $T_{amb} = 25\text{ }^{\circ}\text{C}$

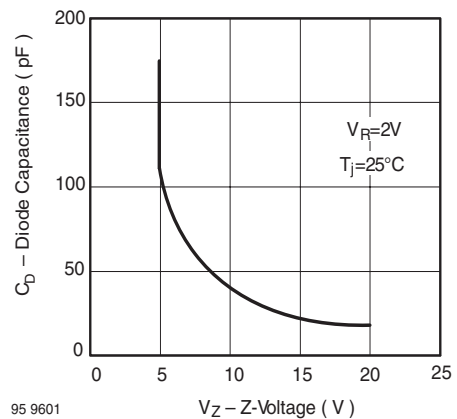

Fig. 6 Diode Capacitance vs. Z-Voltage

ZMM55-B2V4 SERIES

Typical Characteristics ($T_{amb} = 25^\circ\text{C}$ unless otherwise specified)

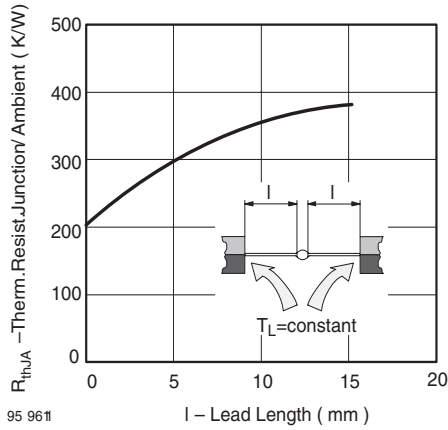

Fig. 1 Thermal Resistance vs. Lead Length

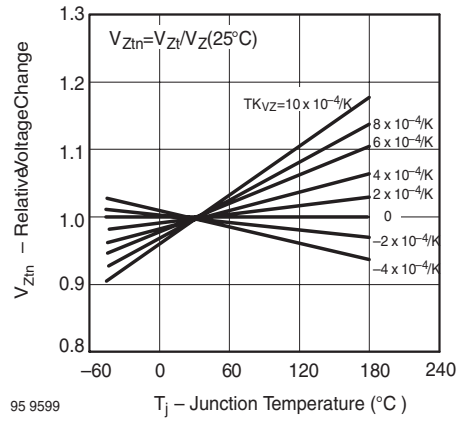

Fig. 4 Typical Change of Working Voltage vs. Junction Temperature

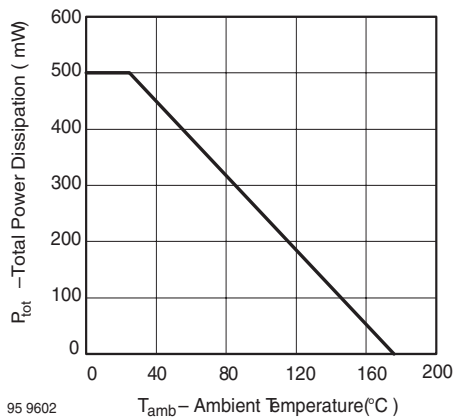

Fig. 2 Total Power Dissipation vs. Ambient Temperature

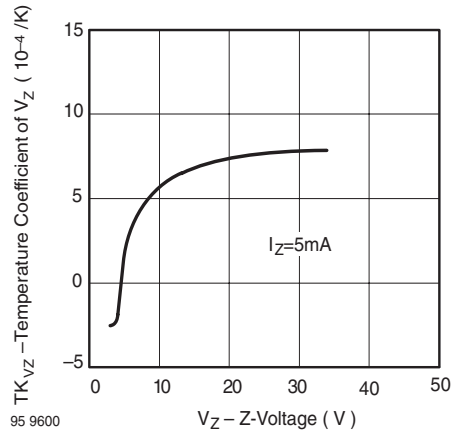

Fig. 5 Temperature Coefficient of Vz vs. Z-Voltage

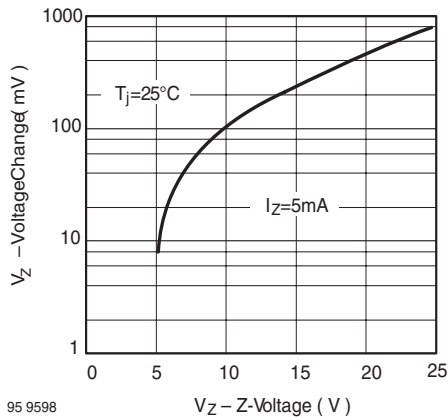

Fig. 3 Typical Change of Working Voltage under Operating Conditions at $T_{amb}=25^\circ\text{C}$

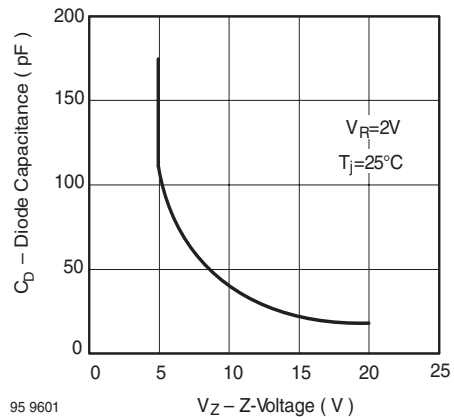

Fig. 6 Diode Capacitance vs. Z-Voltage

ZMM55-B2V4 SERIES

Part No_packing code_Version

ZMM55-B2V4_R1_10001

ZMM55-B2V4_R2_10001

For example :

RB500V-40_R2_00001



Packing Code XX				Version Code XXXXX		
Packing type	1 st Code	Packing size code	2 nd Code	HF or RoHS	1 st Code	2 nd ~5 th Code
Tape and Ammunition Box (T/B)	A	N/A	0	HF	0	serial number
Tape and Reel (T/R)	R	7"	1	RoHS	1	serial number
Bulk Packing (B/P)	B	13"	2			
Tube Packing (T/P)	T	26mm	X			
Tape and Reel (Right Oriented) (TRR)	S	52mm	Y			
Tape and Reel (Left Oriented) (TRL)	L	PANASERT T/B CATHODE UP (PBCU)	U			
FORMING	F	PANASERT T/B CATHODE DOWN (PBCD)	D			

ZMM55-B2V4 SERIES

Disclaimer

- Reproducing and modifying information of the document is prohibited without permission from Panjit International Inc..
- Panjit International Inc. reserves the rights to make changes of the content herein the document anytime without notification. Please refer to our website for the latest document.
- Panjit International Inc. disclaims any and all liability arising out of the application or use of any product including damages incidentally and consequentially occurred.
- Panjit International Inc. does not assume any and all implied warranties, including warranties of fitness for particular purpose, non-infringement and merchantability.
- Applications shown on the herein document are examples of standard use and operation. Customers are responsible in comprehending the suitable use in particular applications. Panjit International Inc. makes no representation or warranty that such applications will be suitable for the specified use without further testing or modification.
- The products shown herein are not designed and authorized for equipments requiring high level of reliability or relating to human life and for any applications concerning life-saving or life-sustaining, such as medical instruments, transportation equipment, aerospace machinery et cetera. Customers using or selling these products for use in such applications do so at their own risk and agree to fully indemnify Panjit International Inc. for any damages resulting from such improper use or sale.
- Since Panjit uses lot number as the tracking base, please provide the lot number for tracking when complaining.