

Nuvoton

**Adjustable Current-Limited,
Power-Distribution Switch**

NCT3527U

NCT3527U-A

-Table of Content-

1.	GENERAL DESCRIPTION	1
2.	FEATURES	1
3.	BLOCK DIAGRAM	2
4.	PIN CONFIGURATION AND TYPICAL APPLICATION CIRCUIT.....	2
5.	PIN DESCRIPTION.....	3
6.	FUNCTIONAL DESCRIPTION.....	3
7.	ELECTRICAL CHARACTERISTIC	6
8.	SWITCHING CHARACTERISTICS	9
9.	PACKAGE DIMENSION	13
10.	ORDERING INFORMATION.....	14
11.	TOP MARKING SPECIFICATION	14
12.	DATA SHEET REVISION HISTORY	15

1. GENERAL DESCRIPTION

The NCT3527U/NCT3527U-A is a high-side adjustable current-limited switch optimized for general purpose power distribution. The device incorporates a 70-mΩ N-channel MOSFET power switch.

The NCT3527U/NCT3527U-A also supports output discharge function via external resistor that provides a controlled discharge of the output voltage stored on the output capacitor. The output current is limited when the output load reaches the current-limit threshold and a guaranteed deglitching time of 3-ms ensures that the transient voltage settles down. If after this blanking time the load current is greater than the current limit, the NCT3527U enters a latch-off state and the NCT3527U-A enters an auto-retry state. In latch-off state, the switch is turned off and FLAG# is issued to the host. The switch can be turned on again by cycling the power. In auto-retry state, the switch would be turned off for 24ms then turn-on again. The NCT3527U/NCT3527U-A provides up to 2.5A load current.

When continuous heavy overloads or short-circuit causes the junction temperature to rise, an over-temperature protection mechanism (OTP) will be activated to shut the switch off to prevent catastrophic failure. Recovery from the OTP is automatic when the junction temperature returns in a reasonable range. The under-voltage lockout (UVLO) can ensure the switch is in off state unless there is a valid input voltage. The NCT3527U/NCT3527U-A is in a TSOT23-6 package.

2. FEATURES

- 70-mΩ High-Side MOSFET Switch
- Maximum 2.5A Load Current
- Adjustable Current Limit Trip Threshold
- Reverse Current Flow Blocking (no body diode)
- Adjustable Output Discharge Function
- Reverse Voltage Protection
- FLAG# Function
- Built in Soft Start
- Thermal Protection
- VIN Under Voltage Lockout
- Fast Current Limit Response Time
- Provides TSOT23-6 Green Package (Pb-free ROHS Compliance and Halogen Free)

APPLICATIONS

- High-Side Power Protection Switch
- Notebook, PC Computers
- Hot Plug-in Power Supplies

3. BLOCK DIAGRAM

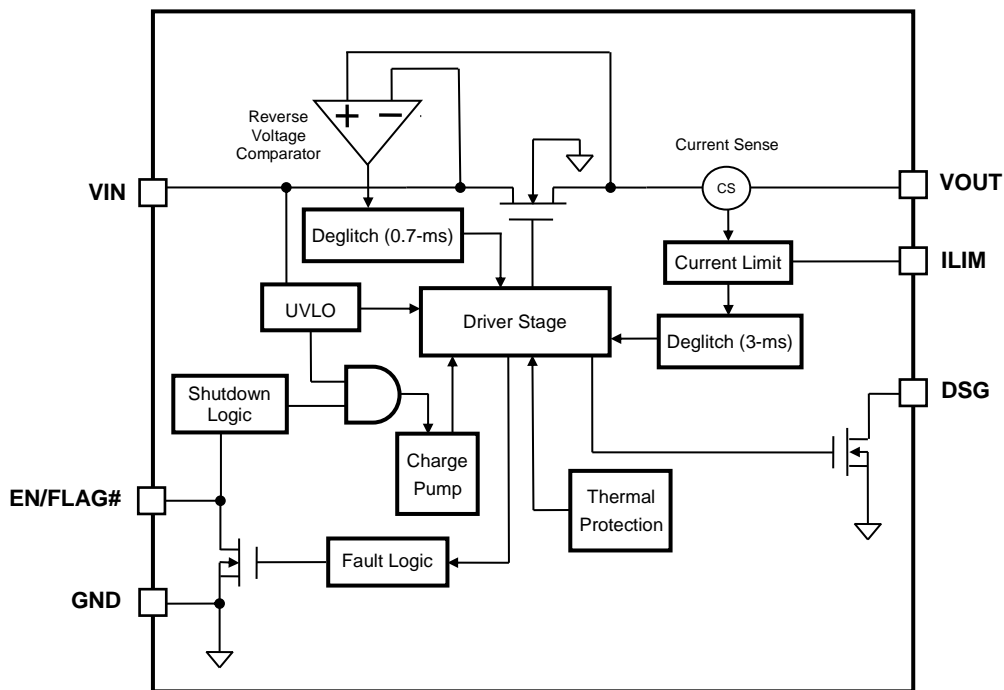

4. PIN CONFIGURATION AND TYPICAL APPLICATION CIRCUIT

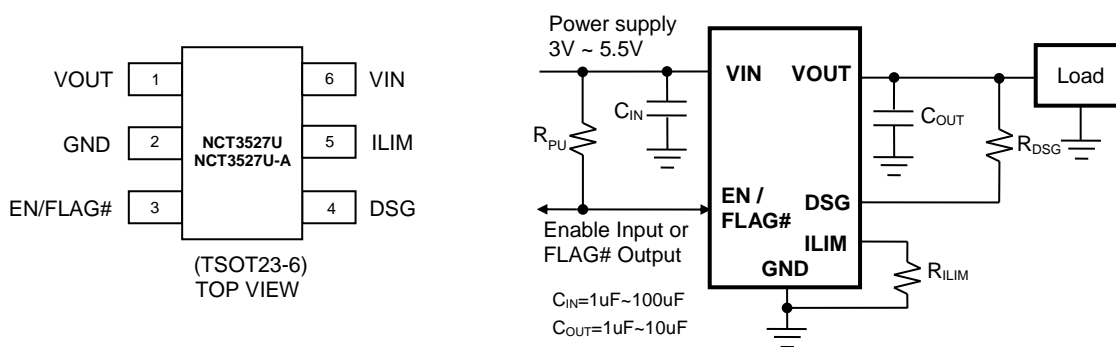

Figure 1 Typical Application Circuit

5. PIN DESCRIPTION

PIN	NAME	I/O	DESCRIPTION
1	VOUT	O	Voltage output pin
2	GND	Ground	Power ground
3	EN/FLAG#	I/O	This is a bi-directional interface pin. As an input pin, pulling up this pin to enable chip and pulling down to disable chip. As an output pin, this pin goes low during fault event(s) occurs.
4	DSG	I	External resistor used to set output discharge current.
5	ILIM	O	External resistor used to set current limit threshold. This pin cannot be left floating.
6	VIN	Power	Supply voltage input pin.

6. FUNCTIONAL DESCRIPTION

Power Switch

The internal power switch is a high-side N-channel MOSFET with low on-state resistance. The device incorporates an internal charge pump and gate driver circuitry to drive the N-channel MOSFET. The charge pump supplies power to the driver circuit and provides necessary voltage to pull the gate of the MOSFET above the source. The charge pump operates from input voltages as low as 3V and requires little supply current. The driver controls the gate voltage to limit the power switch. The driver incorporates circuitry that controls the rise and fall times of the output voltage to limit large current and voltage surges and provides built-in soft start functionality.

EN/FLAG#

This pin serves as both an input and an output. As an output, a logic level fault flag issues to host. As an input, if kept inactive (low) by the host, shuts down the power switch. An external pull up resistor is required.

The FLAG# signal indicates when any of the following conditions occur:

- Over-current fault persists beyond the 3-ms deglitch timeout.
- The chip temperature exceeds the thermal shut down temperature limit of 150°C.
- VIN is below UVLO threshold.

The device features deglitch timeout to blank FLAG# assertion when an over-current condition occurs. Once the deglitching time has elapsed, this output remains asserted (active low) until cycling the VIN below the UVLO to reset the switch. Blanking allows momentary over-current to be ignored, for example, current surges caused by hot-plugging into a capacitive load or when the device is powering up, thus prevent fault alarm from being relayed to the host system. The internal over-current deglitch eliminates the need for external components to remove unwanted

pulses. This FLAG# is not deglitched when the switch is turned off due to an over-temperature shutdown or UVLO condition.

Under-voltage Lockout (UVLO)

An under-voltage lockout prevents the power switch from turning on until input voltage exceeds approximately 2V. If the input voltage drops below approximately 2V, UVLO turns off the power switch.

Current Limit and Short Circuit Protection

The current limit circuitry prevents damage to the power switch and the hub downstream port but can deliver load current through power switch up to the current limit threshold. When a heavy load or short circuit is applied to an enabled switch, a large transient current may flow until the current limit circuitry responds. Once this current is exceeded the over current threshold, the deglitching timer is counting. The timer resets if the over current condition removes before the deglitching time (3-ms, typically) has elapsed.

In latch-off mode (NCT3527U), the switch is turned off if the over current condition continues up to the end of the deglitching time. By cycling the VIN below the UVLO could reset the switch.

In auto-retry mode (NCT3527U-A), the switch is turned off for 24-ms if the over current condition continues up to the end of the deglitching time. Then the switch would be turned on again. The auto-retry function saves system power in case of an overcurrent or short circuit condition.

Current Limit Threshold Setting

The over current threshold is setting via external resistor. The NCT3527U/ NCT3527U-A uses an internal regulation loop to provide a regulated voltage on the ILIM pin. The current limit threshold is proportional to the current sourced out of ILIM pin. Many applications requires that the minimum current limit is above a certain current level or that the maximum current is below a certain current level so it is important to consider the tolerance of the over current threshold when selecting a value for R_{ILIM}. The traces routing the R_{ILIM} resistor to the NCT3527U/ NCT3527U-A should be as short as possible to reduce parasitic effects on the current limit accuracy.

Short-circuit Current vs. R_{ILIM} Values

R _{ILIM} (Ω)	Min. (mA)	Typ. (mA)	Max. (mA)
7.68k	2430	2700	2970
8.25k	2250	2500	2750
9.53k	1980	2200	2420
10.5k	1800	2000	2200
11.5k	1620	1800	1980
14.3k	1350	1500	1650
17.4k	1080	1200	1320
21k	900	1000	1100
34.8k	500	600	700

Reverse Voltage Protection

The reverse-voltage protection turns off the N-channel MOSFET whenever the output voltage exceeds the input voltage 55 mV (typical) for 0.7-ms. It prevents damage to devices on the input side by preventing significant current from sinking into the input capacitance. The N-channel MOSFET is allowed to turn-on once the output voltage goes below the input voltage for the

same 0.7-ms deglitch time. The comparator will active to disable N-channel power MOSFET when $OUT - VIN$ is over 55 mV for delay 0.7-ms.

Discharge Function

When the device is disabled, EN is de-asserted or during power up when VIN is below UVLO threshold, the discharge function is active. By connecting a resistor between DSG pin and VOUT pin, the discharge function offers a discharge path for the external storage capacitor. This is suitable only to discharge filter capacitors for limited time and cannot dissipate steady state current greater than 150mA.

Thermal Shut Down

The device implements a Thermal Sense to monitor the chip temperature. When the chip temperature exceeds 150°C for any reasons, the Thermal Shutdown function turns off the power switch. A Hysteresis of 50°C prevents the switch turning back on until the temperature drops below 100°C.

Input and Output Capacitor

Place a 1~100uF bypass capacitor between VIN to GND, close to the device, is recommended to reduce power-supply transients that may cause ringing on the input. Furthermore, without the bypass capacitor, an output short may cause the input ringing (due to the inductance from power supply to VIN) to destroy the internal control circuitry. Additionally, bypassing the output with a 1~10uF capacitor improves the immunity of the device to short-circuit transients.

Placing a high value capacitor on the output pin is recommended when large currents are expected on the output.

Layout Consideration

It is important to keep all traces as short as possible to reduce the effect of undesirable parasitic inductance and the switch response time to output short circuit condition. Place input and output capacitors as close as possible to the device.

**7. ELECTRICAL CHARACTERISTIC
ABSOLUTE MAXIMUM RATINGS**

ITEM		RATING	UNIT
Input voltage, VIN		-0.3 ~ 6	V
Output voltage, VOUT		-0.3 ~ 6	V
Continuous output current		Internally Limited	A
Peak Discharge Current, DSG		200	mA
Junction temperature		-40 ~ 150	°C
Storage temperature		-50 ~ 150	°C
Soldering temperature		Refer to IPC/JEDEC J-STD-020 Specification	
Electrostatic discharge protection	Human Body Mode	2	kV
	Machine Mode	200	V
Electrostatic discharge protection, Latch-Up		±100	mA

NOTE : Stresses beyond those listed under “absolute maximum ratings” may cause permanent damage to the device .These are stress ratings only And functional operation of the device at these or any other conditions beyond those indicated under “recommended operating condition” is not implied. Exposure to absolute-maximum-rated conditions for extended periods may affect device reliability.

THERMAL INFORMATION

PARAMETER		RATING	UNIT
Power dissipation, P _D @ T _A =25°C	TSOT23-6	0.5	W
Package thermal resistance	TSOT23-6, θ _{JA}	220	°C/W
	TSOT23-6, θ _{JC}	90	°C/W

RECOMMENDED OPERATING CONDITIONS

PARAMETER	VALUE	UNIT
Input voltage, VIN	3.0 ~ 5.5	V
Voltage on EN/FLAG# and DSG	-0.3 ~ VIN+0.3	V
EN/FLAG# pull up resistance	1 ~ 10	kΩ
DSG discharge current	0 ~ 150	mA
Continuous output current	0 ~ 2.5	A
Current limit threshold resistor range for ILIM to GND	25 ~ 100	kΩ
VIN capacitance	1 ~ 100	uF
VOUT capacitance	1 ~ 10	uF
T _A , Operating temperature	-40 ~ 85	°C

DC ELECTRICAL CHARACTERISTICS

VIN=5V, TA=-40°C to 85°C, Typical Values are at TA=25°C. Unless otherwise specified.

PARAMETER		TEST CONDITIONS	MIN	TYP	MAX	UNIT	
Power Switch							
R _{DS(on)}	Static drain-source on-state resistance	I _{OUT} = 1A, T _A =25°C		70	110	mΩ	
R _{DIS}	Output Discharge Resistance	I _{DIS} = 1mA, EN=0V, T _A =25°C		15	30	Ω	
Current Limit							
I _{OS}	$I_{OS} = \frac{21000}{R_{LIM}}$	R _{LIM} = 34.8 kΩ, T _A =25°C	0.5	0.6	0.7	A	
		R _{LIM} = 21 kΩ, T _A =25°C	0.9	1.0	1.1	A	
		R _{LIM} = 10.5 kΩ, T _A =25°C	1.82	2.0	2.22	A	
		R _{LIM} = 7.68 kΩ, T _A =25°C	2.43	2.7	2.97	A	
I _{OC}	Over-current Trip Threshold	VIN=5V, Current Ramp (0.001 A/us) on VOUT	R _{LIM} = 34.8 kΩ	0.57	0.69	0.81	A
			R _{LIM} = 21 kΩ	1.04	1.15	1.27	A
			R _{LIM} = 10.5 kΩ	2.07	2.3	2.53	A
			R _{LIM} = 7.68 kΩ	2.79	3.1	3.42	A
		VIN=5V, Continuous Current on VOUT	R _{LIM} = 34.8 kΩ	0.55	0.65	0.75	A
			R _{LIM} = 21 kΩ	0.99	1.1	1.21	A
			R _{LIM} = 10.5 kΩ	1.98	2.2	2.42	A
			R _{LIM} = 7.68 kΩ	2.67	2.97	3.27	A
t _{IOS}	Response time to short circuit	VIN=5V, T _A =25°C		5		us	
t _{IOC}	Over current blanking time	VIN=5V, T _A =25°C	2	3	4	ms	
t _{OCRT}	Retry time		10	24	35	ms	
Operating Current							
I _{CC}	Supply current	EN=5V, No Load, not including I _{RLIM}		150	200	uA	
I _{SD}	Shutdown current	EN=0V		45	65	uA	
I _{OUT_LEAK}	VOUT leakage current	EN=0V			1	uA	
I _{REV}	Reverse leakage current to VIN	VOUT=5V, VIN=0V			1	uA	
EN/FLAG#							
V _{IH}	Input logic High level	T _A =-40°C ~ 85°C	1.2			V	
V _{IL}	Input logic Low level	T _A =-40°C ~ 85°C			0.8	V	
	Hysteresis			0.2		V	
I _{EN_LEAK}	Leakage current	EN=5.5V or GND			1	uA	
I _{SINK}	Sink current	EN=0.4V		2		mA	
Under-Voltage Lockout							
UVLO	Low level input voltage	VIN Rising	2		2.6	V	
	Hysteresis	T _A =25°C		200		mV	
Reverse Voltage Protection							

VOUT-VIN	Reverse voltage protection threshold		30	55	80	mV
	Reverse voltage blanking time		0.5	0.7	1	ms
Timing						
t_r	Rise time	$C_L=10\mu\text{F}, R_L=5\Omega, T_A=25^\circ\text{C}$	2	3		ms
t_f	Fall time	$C_L=10\mu\text{F}, R_L=5\Omega, R_{\text{DSG}}=33\Omega, T_A=25^\circ\text{C}$	0.2	1		ms
t_{on}	Turn on time	$C_L=10\mu\text{F}, R_L=5\Omega, T_A=25^\circ\text{C}$	2.5	3.5		ms
t_{off}	Turn off time	$C_L=10\mu\text{F}, R_L=5\Omega, R_{\text{DSG}}=33\Omega, T_A=25^\circ\text{C}$	0.4	1.2		ms
Thermal shutdown						
T_{SD}	Thermal shutdown threshold	Design guarantee	125	150		$^\circ\text{C}$
	Hysteresis			50		$^\circ\text{C}$

● **PARAMETER MEASURE INFORMATION**

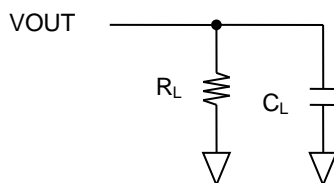

Test Circuit

● **TIMING DIAGRAM**

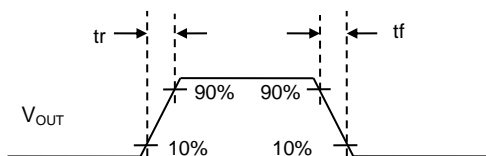

Output Rise and Fall time

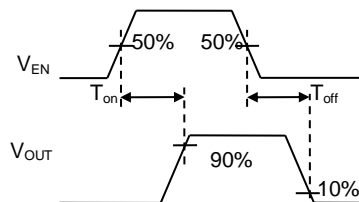

Turn-on Time and Turn-off Time

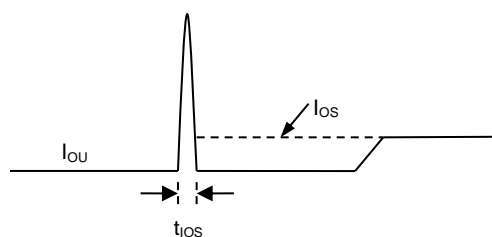

Response time to short circuit waveform

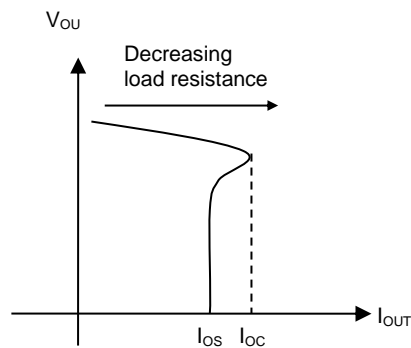

VOUT vs. Current limit threshold

8. SWITCHING CHARACTERISTICS

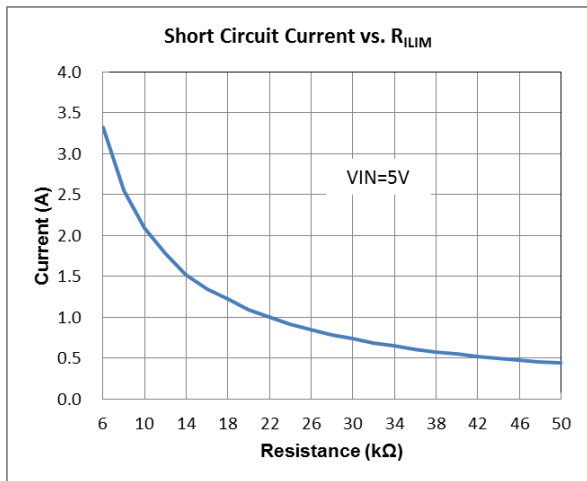
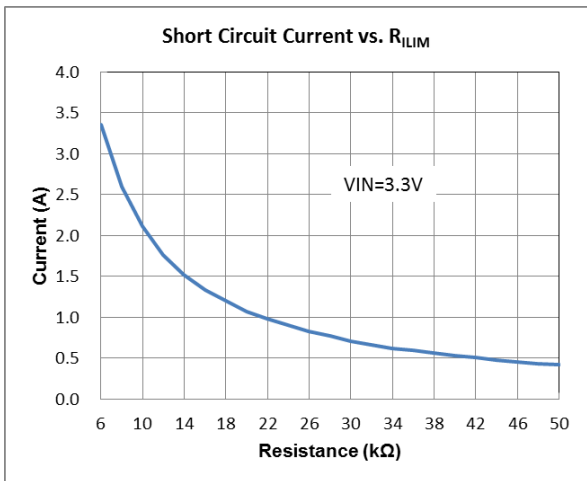
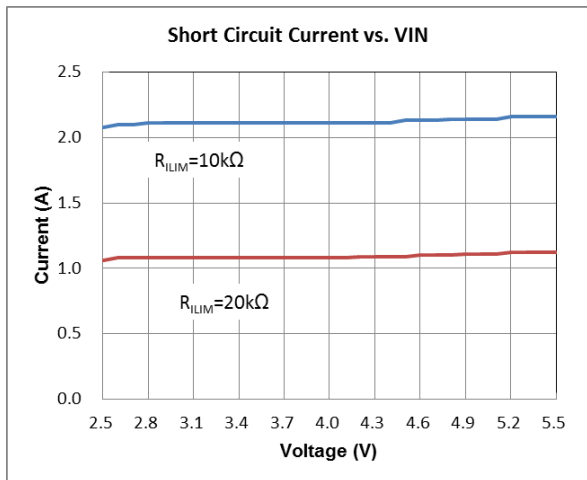
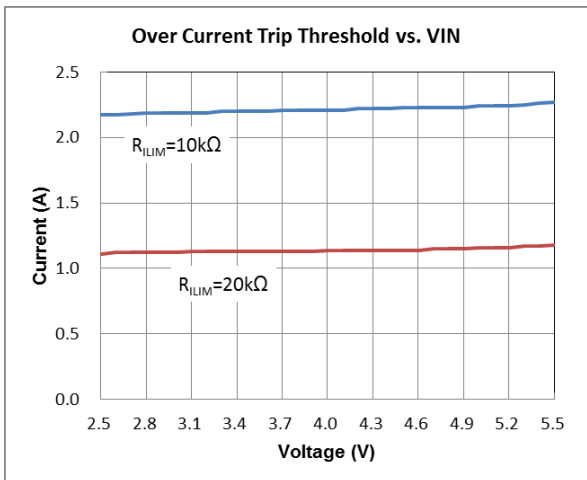
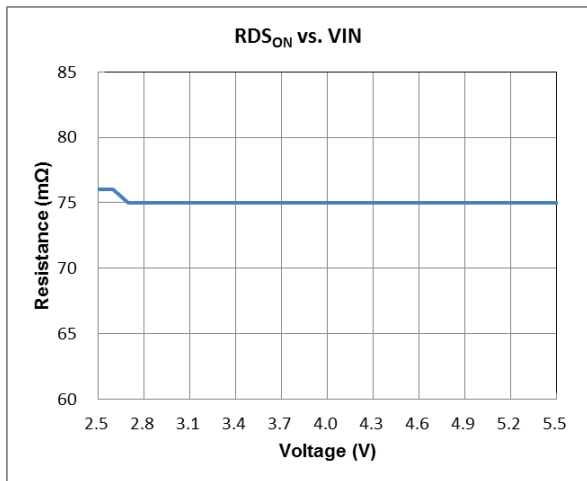
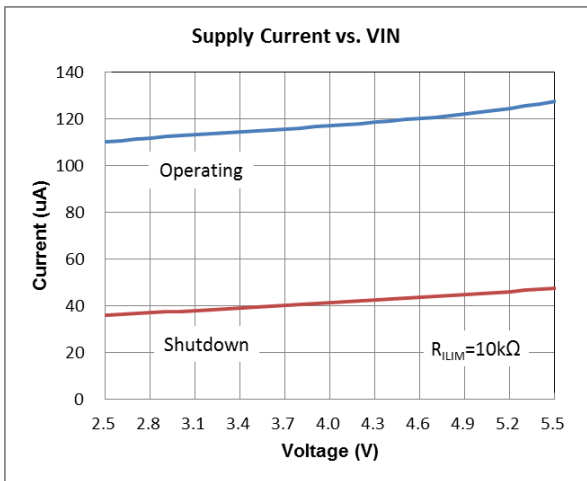

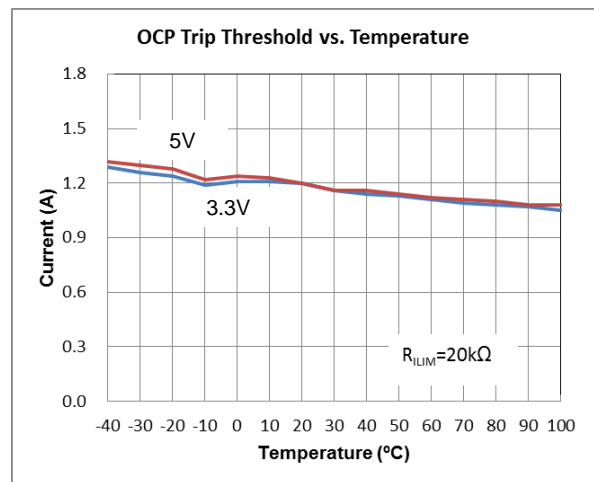
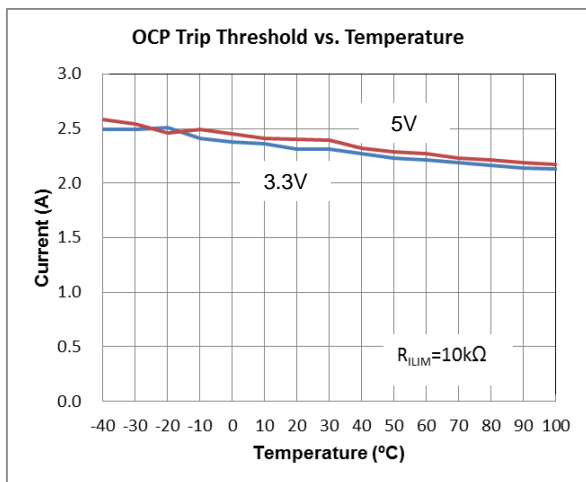
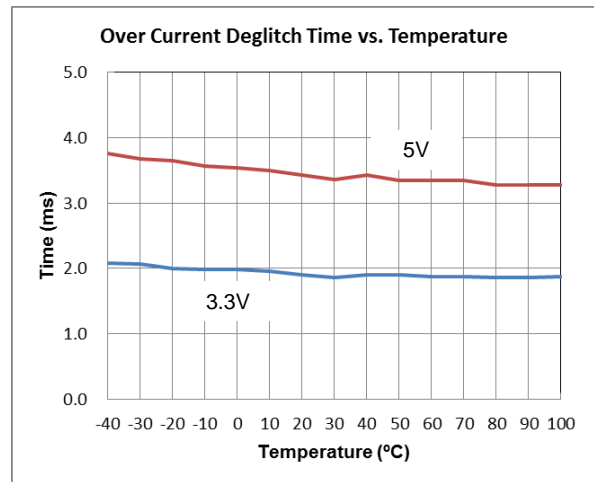
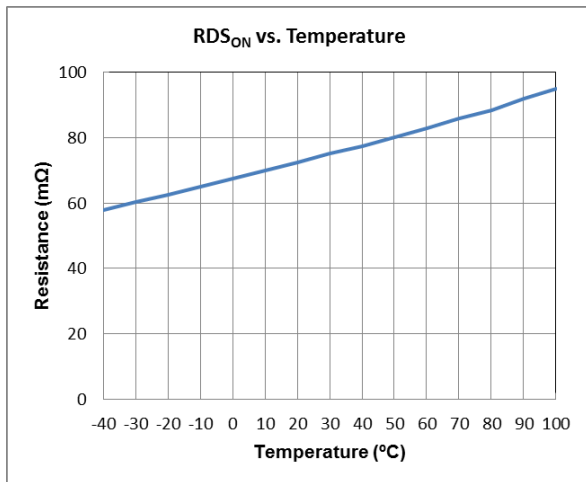
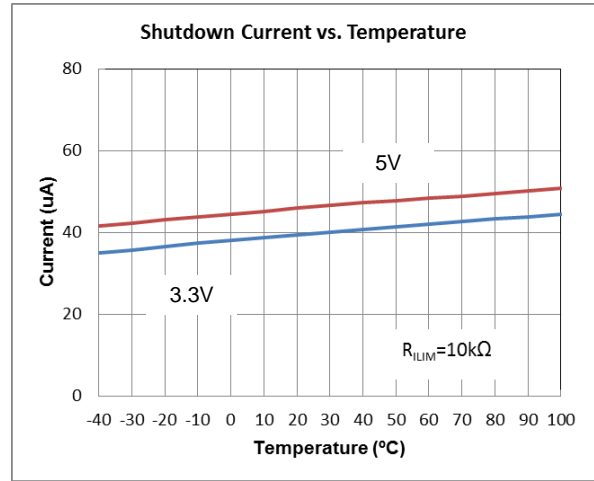
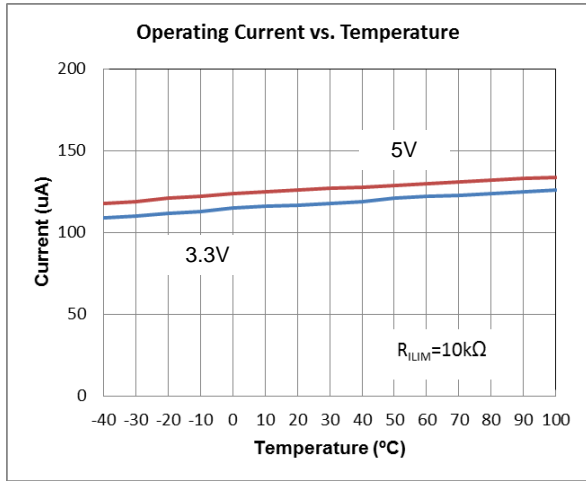

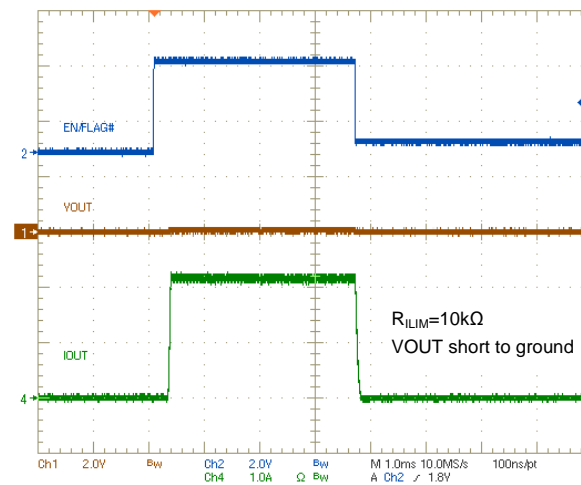
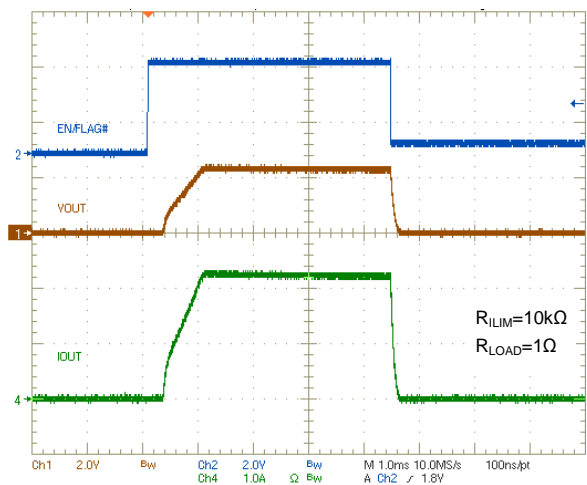
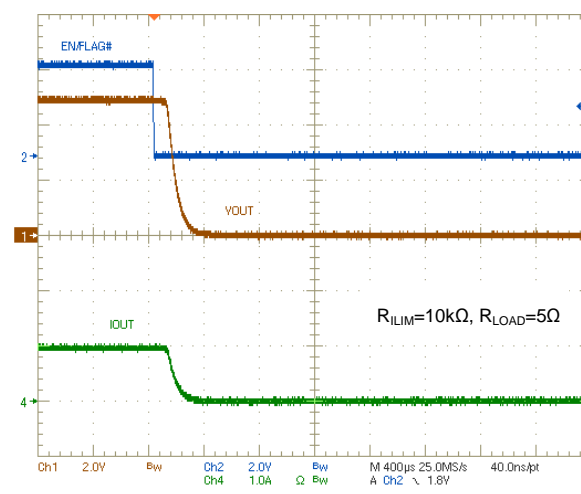
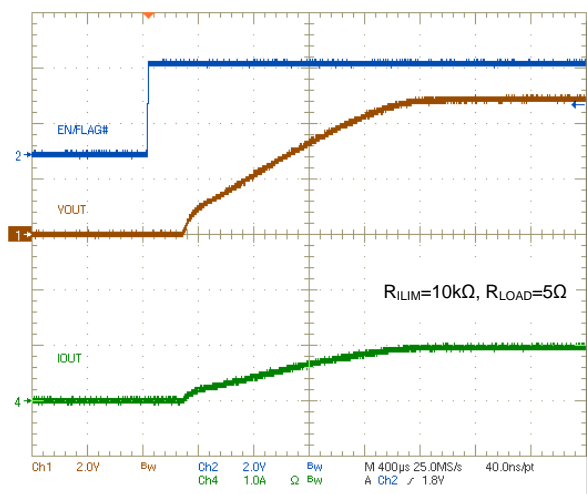
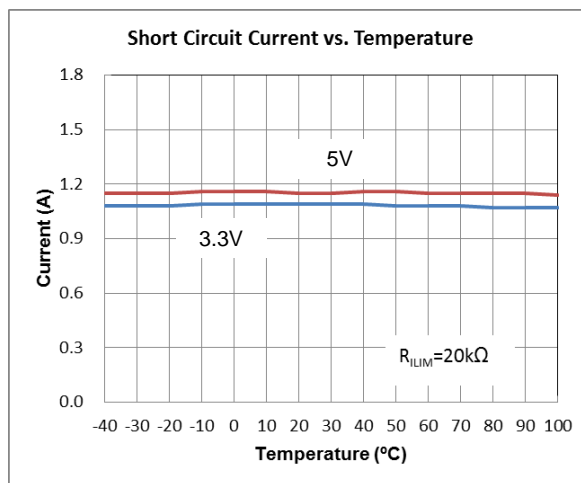
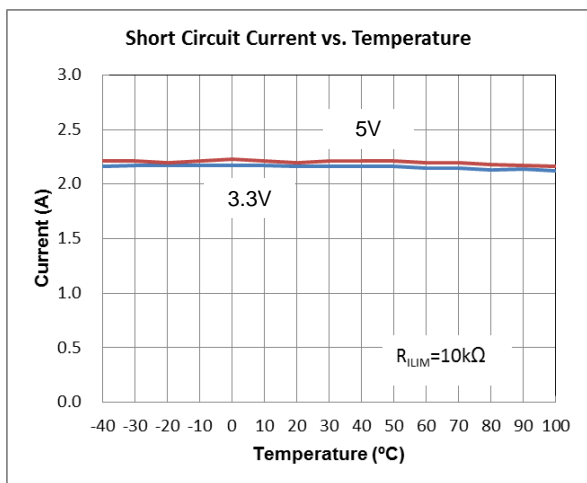

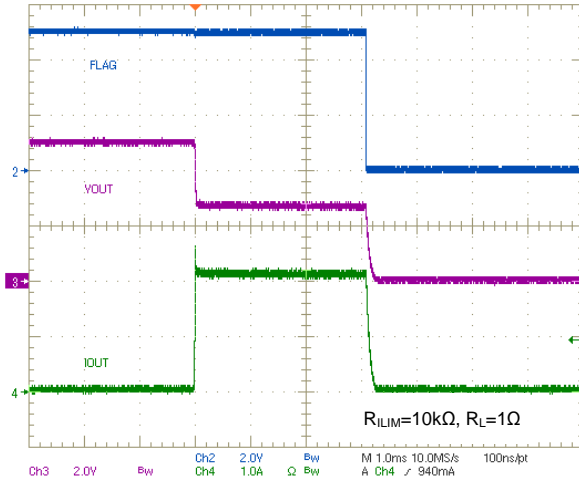

Over current protection: Latch off Mode

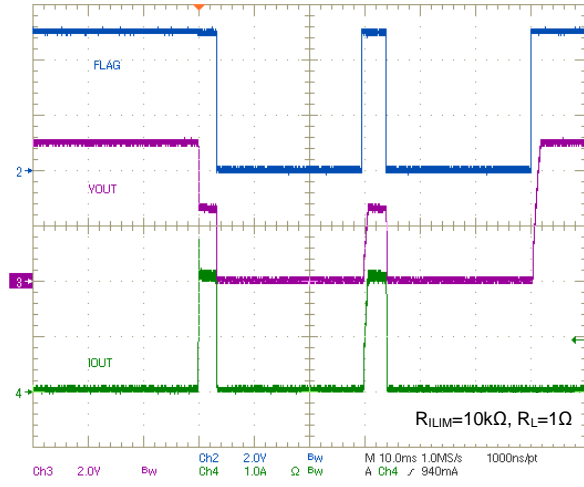

Over current protection: Auto-retry Mode

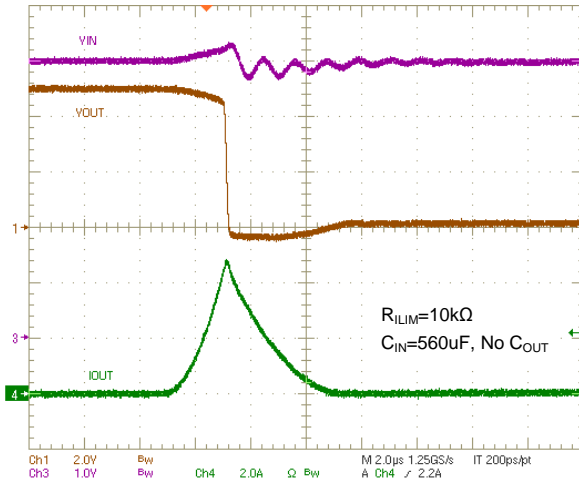

Short circuit response

9. PACKAGE DIMENSION

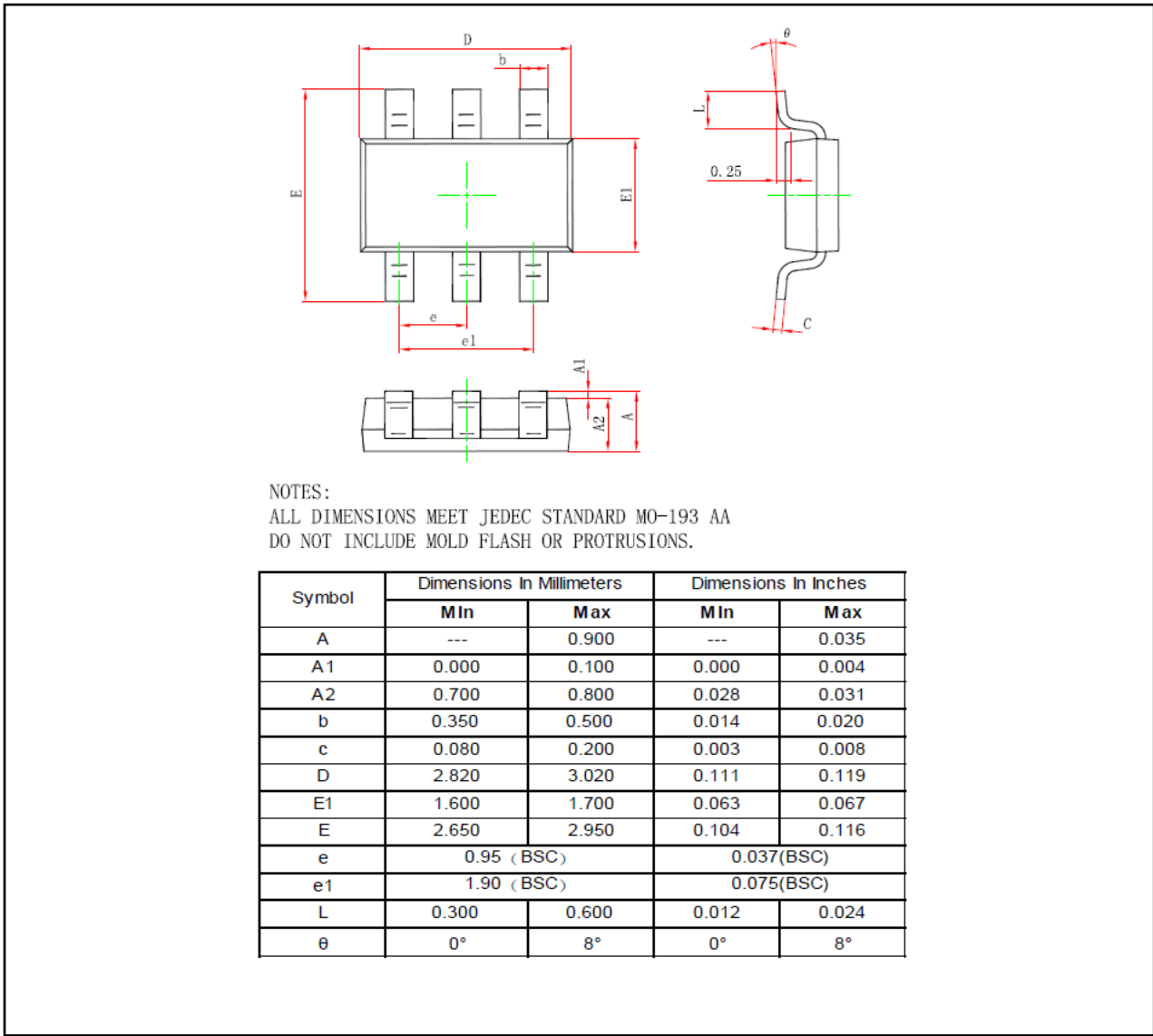

● Taping Specification

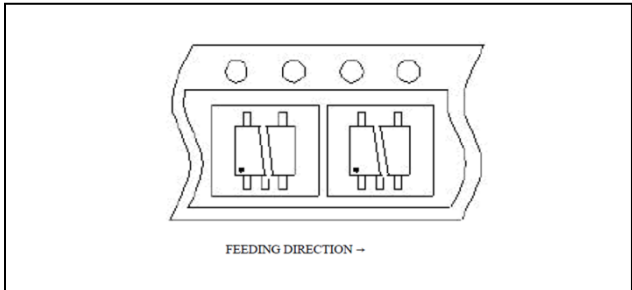

10. ORDERING INFORMATION

PART NUMBER	CURRENT LIMIT	SUPPLIED AS	PACKAGE TYPE	OPERATING TEMPERATURE RANGE
NCT3527U	Latch-off	T Shape: 3,000 units/T&R	6 PIN TSOT23 (Green package)	Commercial, -40°C to 85°C
NCT3527U-A	Auto-retry	T Shape: 3,000 units/T&R	6 PIN TSOT23 (Green package)	Commercial, -40°C to 85°C

11. TOP MARKING SPECIFICATION

27XYM

1st Line: **27** (NCT3527U/NCT3527U-A)

- X: A for NCT3527U, B for NCT3527U-A
- YM: The last character of calendar year (Y) + month (M)
(1: Jan., 2: Feb., 3: Mar., 4: Apr., 5: May, 6: Jul., 7:Jul., 8: Aug., 9: Sep., A: Oct., B: Nov., C: Dec.)

12. DATA SHEET REVISION HISTORY

VERSION	DATE	PAGE	DESCRIPTION
A0	Jul.,2014	All	First Release

Important Notice

Nuvoton Products are neither intended nor warranted for usage in systems or equipment, any malfunction or failure of which may cause loss of human life, bodily injury or severe property damage. Such applications are deemed, "Insecure Usage".

Insecure usage includes, but is not limited to: equipment for surgical implementation, atomic energy control instruments, airplane or spaceship instruments, the control or operation of dynamic, brake or safety systems designed for vehicular use, traffic signal instruments, all types of safety devices, and other applications intended to support or sustain life.

All Insecure Usage shall be made at customer's risk, and in the event that third parties lay claims to Nuvoton as a result of customer's Insecure Usage, customer shall indemnify the damages and liabilities thus incurred by Nuvoton.

*Please note that all data and specifications are subject to change without notice.
All the trademarks of products and companies mentioned in this datasheet belong to their respective owners.*