

74LVC244A-Q100; 74LVCH244A-Q100

Octal buffer/line driver; 3-state

Rev. 5 — 8 April 2020

Product data sheet

1. General description

The 74LVC244A-Q100; 74LVCH244A-Q100 is an octal non-inverting buffer/line driver with 3-state outputs. The 3-state outputs are controlled by the output enable inputs $1\overline{OE}$ and $2\overline{OE}$. A HIGH on $n\overline{OE}$ causes the outputs to assume a high-impedance OFF-state. Schmitt-trigger action at all inputs makes the circuit highly tolerant for slower input rise and fall times.

Inputs can be driven from either 3.3 V or 5.0 V devices. In 3-state operation, outputs can handle 5 V. These features allow the use of these devices as translators in a mixed 3.3 V and 5 V environment.

The 74LVCH244A-Q100 bus hold on data inputs eliminates the need for external pull-up resistors to hold unused inputs.

This product has been qualified to the Automotive Electronics Council (AEC) standard Q100 (Grade 1) and is suitable for use in automotive applications.

2. Features and benefits

- Automotive product qualification in accordance with AEC-Q100 (Grade 1)
 - Specified from -40 °C to +85 °C and from -40 °C to +125 °C
- 5 V tolerant inputs/outputs for interfacing with 5 V logic
- Wide supply voltage range from 1.2 V to 3.6 V
- CMOS low-power consumption
- Direct interface with TTL levels
- Inputs accept voltages up to 5.5 V
- High-impedance when $V_{CC} = 0$ V
- Bus hold on all data inputs (74LVCH244A-Q100 only)
- Complies with JEDEC standard:
 - JESD8-7A (1.65 V to 1.95 V)
 - JESD8-5A (2.3 V to 2.7 V)
 - JESD8-C/JESD36 (2.7 V to 3.6 V)
- ESD protection:
 - MIL-STD-883, method 3015 exceeds 2000 V
 - HBM JESD22-A114F exceeds 2000 V
 - MM JESD22-A115-A exceeds 200 V (C = 200 pF, R = 0 Ω)
- Multiple package options
- DHVQFN package with Side-Wettable Flanks enabling Automatic Optical Inspection (AOI) of solder joints

3. Ordering information

Table 1. Ordering information

Type number	Package			Version
	Temperature range	Name	Description	
74LVC244AD-Q100	-40 °C to +125 °C	SO20	plastic small outline package; 20 leads; body width 7.5 mm	SOT163-1
74LVCH244AD-Q100				
74LVCH244ADB-Q100	-40 °C to +125 °C	SSOP20	plastic shrink small outline package; 20 leads; body width 5.3 mm	SOT339-1
74LVC244APW-Q100	-40 °C to +125 °C	TSSOP20	plastic thin shrink small outline package; 20 leads; body width 4.4 mm	SOT360-1
74LVCH244APW-Q100				
74LVC244ABQ-Q100	-40 °C to +125 °C	DHVQFN20	plastic dual in-line compatible thermal enhanced very thin quad flat package; no leads; 20 terminals; body 2.5 × 4.5 × 0.85 mm	SOT764-1
74LVCH244ABQ-Q100				

4. Functional diagram

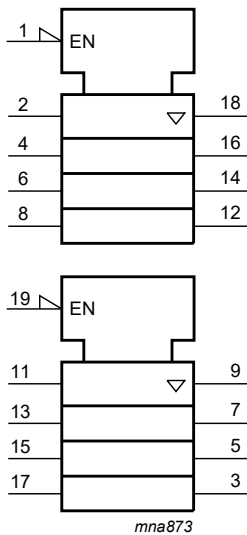

Fig. 1. IEC logic diagram

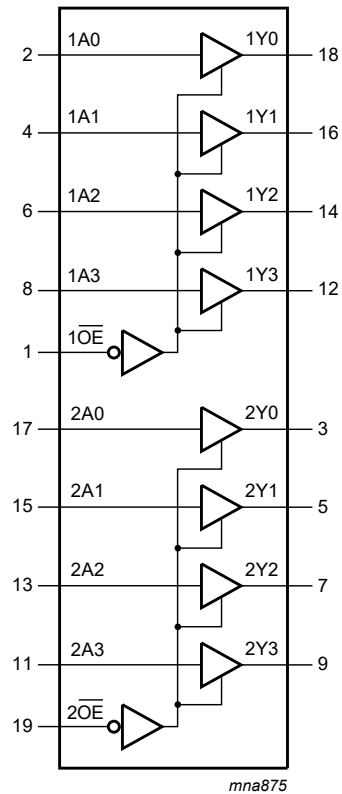

Fig. 2. Functional diagram

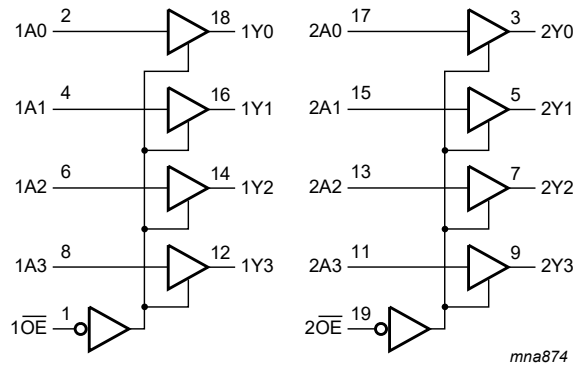

Fig. 3. Logic symbol

5. Pinning information

5.1. Pinning

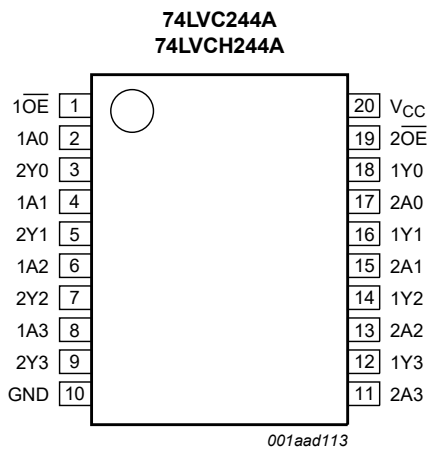

Fig. 4. Pin configuration SOT163-1 (SO20), SOT339-1 (SSOP20) and SOT360-1 (TSSOP20)



(1) This is not a ground pin. There is no electrical or mechanical requirement to solder the pad. In case soldered, the solder land should remain floating or connected to GND.

Fig. 5. Pin configuration SOT764-1 (DHVQFN20)

5.2. Pin description

Table 2. Pin description

Symbol	Pin	Description
$1\overline{OE}$, $2\overline{OE}$	1, 19	output enable input (active low)
1A0, 1A1, 1A2, 1A3	2, 4, 6, 8	data input
2Y0, 2Y1, 2Y2, 2Y3	3, 5, 7, 9	data output
GND	10	ground (0 V)
2A0, 2A1, 2A2, 2A3	17, 15, 13, 11	data input
1Y0, 1Y1, 1Y2, 1Y3,	18, 16, 14, 12	data output
V_{CC}	20	supply voltage

6. Functional description

Table 3. Function table

H = HIGH voltage level; L = LOW voltage level; X = don't care; Z = high-impedance OFF-state.

Control	Input	Output
$n\overline{OE}$	nAn	nYn
L	L	L
L	H	H
H	X	Z

7. Limiting values

Table 4. Limiting values

In accordance with the Absolute Maximum Rating System (IEC 60134). Voltages are referenced to GND (ground = 0 V).

Symbol	Parameter	Conditions	Min	Max	Unit
V_{CC}	supply voltage		-0.5	+6.5	V
I_{IK}	input clamping current	$V_I < 0$ V	-50	-	mA
V_I	input voltage		[1] -0.5	+6.5	V
I_{OK}	output clamping current	$V_O > V_{CC}$ or $V_O < 0$ V	-	± 50	mA
V_O	output voltage	output HIGH or LOW	[2] -0.5	$V_{CC} + 0.5$	V
		output 3-state	[2] -0.5	+6.5	V
I_O	output current	$V_O = 0$ V to V_{CC}	-	± 50	mA
I_{CC}	supply current		-	100	mA
I_{GND}	ground current		-100	-	mA
T_{stg}	storage temperature		-65	+150	°C
P_{tot}	total power dissipation	$T_{amb} = -40$ °C to +125 °C	[3] -	500	mW

[1] The minimum input voltage ratings may be exceeded if the input current ratings are observed.

[2] The output voltage ratings may be exceeded if the output current ratings are observed.

[3] For SOT163-1 (SO20) package: P_{tot} derates linearly with 12.3 mW/K above 109 °C.

For SOT339-1 (SSOP20) package: P_{tot} derates linearly with 10.0 mW/K above 100 °C.

For SOT360-1 (TSSOP20) package: P_{tot} derates linearly with 10.0 mW/K above 100 °C.

For SOT764-1 (DHVQFN20) package: P_{tot} derates linearly with 12.9 mW/K above 111 °C.

8. Recommended operating conditions

Table 5. Recommended operating conditions

Symbol	Parameter	Conditions	Min	Typ	Max	Unit
V _{CC}	supply voltage		1.65	-	3.6	V
		functional	1.2	-	3.6	V
V _I	input voltage		0	-	5.5	V
V _O	output voltage	output HIGH or LOW	0	-	V _{CC}	V
		output 3-state	0	-	5.5	V
T _{amb}	ambient temperature	in free air	-40	-	+125	°C
Δt/ΔV	input transition rise and fall rate	V _{CC} = 1.2 V to 2.7 V	0	-	20	ns/V
		V _{CC} = 2.7 V to 3.6 V	0	-	10	ns/V

9. Static characteristics

Table 6. Static characteristics

At recommended operating conditions. Voltages are referenced to GND (ground = 0 V).

Symbol	Parameter	Conditions	-40 °C to +85 °C			-40 °C to +125 °C		Unit
			Min	Typ [1]	Max	Min	Max	
V _{IH}	HIGH-level input voltage	V _{CC} = 1.2 V	1.08	-	-	1.08	-	V
		V _{CC} = 1.65 V to 1.95 V	0.65V _{CC}	-	-	0.65V _{CC}	-	V
		V _{CC} = 2.3 V to 2.7 V	1.7	-	-	1.7	-	V
		V _{CC} = 2.7 V to 3.6 V	2.0	-	-	2.0	-	V
V _{IL}	LOW-level input voltage	V _{CC} = 1.2 V	-	-	0.12	-	0.12	V
		V _{CC} = 1.65 V to 1.95 V	-	-	0.35V _{CC}	-	0.35V _{CC}	V
		V _{CC} = 2.3 V to 2.7 V	-	-	0.7	-	0.7	V
		V _{CC} = 2.7 V to 3.6 V	-	-	0.8	-	0.8	V
V _{OH}	HIGH-level output voltage	V _I = V _{IH} or V _{IL}						
		I _O = -100 μA; V _{CC} = 1.65 V to 3.6 V	V _{CC} - 0.2	-	-	V _{CC} - 0.3	-	V
		I _O = -4 mA; V _{CC} = 1.65 V	1.2	-	-	1.05	-	V
		I _O = -8 mA; V _{CC} = 2.3 V	1.8	-	-	1.65	-	V
		I _O = -12 mA; V _{CC} = 2.7 V	2.2	-	-	2.05	-	V
		I _O = -18 mA; V _{CC} = 3.0 V	2.4	-	-	2.25	-	V
V _{OL}	LOW-level output voltage	V _I = V _{IH} or V _{IL}						
		I _O = 100 μA; V _{CC} = 1.65 V to 3.6 V	-	-	0.2	-	0.3	V
		I _O = 4 mA; V _{CC} = 1.65 V	-	-	0.45	-	0.65	V
		I _O = 8 mA; V _{CC} = 2.3 V	-	-	0.6	-	0.8	V
		I _O = 12 mA; V _{CC} = 2.7 V	-	-	0.4	-	0.6	V
		I _O = 24 mA; V _{CC} = 3.0 V	-	-	0.55	-	0.8	V

Symbol	Parameter	Conditions	-40 °C to +85 °C			-40 °C to +125 °C		Unit
			Min	Typ [1]	Max	Min	Max	
I_I	input leakage current	$V_I = 5.5 \text{ V}$ or GND; $V_{CC} = 3.6 \text{ V}$ [2]	-	± 0.1	± 5	-	± 20	μA
I_{OZ}	OFF-state output current	$V_I = V_{IH}$ or V_{IL} ; $V_O = 5.5 \text{ V}$ or GND; $V_{CC} = 3.6 \text{ V}$ [2]	-	± 0.1	± 5	-	± 20	μA
I_{OFF}	power-off leakage current	V_I or $V_O = 5.5 \text{ V}$; $V_{CC} = 0.0 \text{ V}$	-	± 0.1	± 10	-	± 20	μA
I_{CC}	supply current	$V_I = V_{CC}$ or GND; $I_O = 0 \text{ A}$; $V_{CC} = 3.6 \text{ V}$	-	0.1	10	-	40	μA
ΔI_{CC}	additional supply current	per input pin; $V_I = V_{CC} - 0.6 \text{ V}$; $I_O = 0 \text{ A}$; $V_{CC} = 2.7 \text{ V}$ to 3.6 V	-	5	500	-	5000	μA
C_I	input capacitance		-	4.0	-	-	-	pF
I_{BHL}	bus hold LOW current	$V_{CC} = 1.65 \text{ V}$; $V_I = 0.58 \text{ V}$ [3][4]	10	-	-	10	-	μA
		$V_{CC} = 2.3 \text{ V}$; $V_I = 0.7 \text{ V}$	30	-	-	25	-	μA
		$V_{CC} = 3.0 \text{ V}$; $V_I = 0.8 \text{ V}$	75	-	-	60	-	μA
I_{BHH}	bus hold HIGH current	$V_{CC} = 1.65 \text{ V}$; $V_I = 1.07 \text{ V}$ [3][4]	-10	-	-	-10	-	μA
		$V_{CC} = 2.3 \text{ V}$; $V_I = 1.7 \text{ V}$	-30	-	-	-25	-	μA
		$V_{CC} = 3.0 \text{ V}$; $V_I = 2.0 \text{ V}$	-75	-	-	-60	-	μA
I_{BHLO}	bus hold LOW overdrive current	$V_{CC} = 1.95 \text{ V}$ [3][5]	200	-	-	200	-	μA
		$V_{CC} = 2.7 \text{ V}$	300	-	-	300	-	μA
		$V_{CC} = 3.6 \text{ V}$	500	-	-	500	-	μA
I_{BHHO}	bus hold HIGH overdrive current	$V_{CC} = 1.95 \text{ V}$ [3][5]	-200	-	-	-200	-	μA
		$V_{CC} = 2.7 \text{ V}$	-300	-	-	-300	-	μA
		$V_{CC} = 3.6 \text{ V}$	-500	-	-	-500	-	μA

[1] All typical values are measured at $V_{CC} = 3.3 \text{ V}$ (unless stated otherwise) and $T_{amb} = 25 \text{ }^\circ\text{C}$.

[2] The bus hold circuit is switched off when $V_I > V_{CC}$ allowing 5.5 V on the input terminal.

[3] Valid for data inputs of bus hold parts only (74LVCH244A-Q100). Note that control inputs do not have a bus hold circuit.

[4] The specified sustaining current at the data input holds the input below the specified V_I level.

[5] The specified overdrive current at the data input forces the data input to the opposite input state.

10. Dynamic characteristics

Table 7. Dynamic characteristics

Voltages are referenced to GND (ground = 0 V). For test circuit see Fig. 8.

Symbol	Parameter	Conditions	-40 °C to +85 °C			-40 °C to +125 °C		Unit
			Min	Typ [1]	Max	Min	Max	
t _{pd}	propagation delay	nAn to nYn; see Fig. 6 [2]						
		V _{CC} = 1.2 V	-	17.0	-	-	-	ns
		V _{CC} = 1.65 V to 1.95 V	1.5	6.4	13.7	1.5	15.8	ns
		V _{CC} = 2.3 V to 2.7 V	1.0	3.4	7.1	1.0	8.2	ns
		V _{CC} = 2.7 V	1.5	3.4	6.9	1.5	9.0	ns
t _{en}	enable time	nOE to nYn; see Fig. 7 [2]						
		V _{CC} = 1.2 V	-	24.0	-	-	-	ns
		V _{CC} = 1.65 V to 1.95 V	1.5	7.0	17.3	1.5	20.0	ns
		V _{CC} = 2.3 V to 2.7 V	1.5	3.9	9.5	1.5	11.0	ns
		V _{CC} = 2.7 V	1.5	4.1	8.6	1.5	11.0	ns
t _{dis}	disable time	nOE to nYn; see Fig. 7 [2]						
		V _{CC} = 1.2 V	-	9.0	-	-	-	ns
		V _{CC} = 1.65 V to 1.95 V	2.2	4.5	9.8	2.2	11.3	ns
		V _{CC} = 2.3 V to 2.7 V	0.5	3.6	5.5	0.5	6.4	ns
		V _{CC} = 2.7 V	1.5	3.3	6.8	1.5	8.5	ns
t _{sk(o)}	output skew time	[3]	-	-	1.0	-	1.5	ns
C _{PD}	power dissipation capacitance	per input; V _I = GND to V _{CC} [4]						
		V _{CC} = 1.65 V to 1.95 V	-	6.4	-	-	-	pF
		V _{CC} = 2.3 V to 2.7 V	-	9.6	-	-	-	pF
		V _{CC} = 3.0 V to 3.6 V	-	12.5	-	-	-	pF

[1] Typical values are measured at T_{amb} = 25 °C and V_{CC} = 1.2 V, 1.8 V, 2.5 V, 2.7 V, and 3.3 V respectively.

[2] t_{pd} is the same as t_{PLH} and t_{PHL}.

t_{en} is the same as t_{PZL} and t_{PZH}.

t_{dis} is the same as t_{PLZ} and t_{PHZ}.

[3] Skew between any two outputs of the same package switching in the same direction. This parameter is guaranteed by design.

[4] C_{PD} is used to determine the dynamic power dissipation (P_D in μW).

$P_D = C_{PD} \times V_{CC}^2 \times f_i \times N + \Sigma(C_L \times V_{CC}^2 \times f_o)$ where:

f_i = input frequency in MHz; f_o = output frequency in MHz

C_L = output load capacitance in pF

V_{CC} = supply voltage in Volts

N = number of inputs switching

$\Sigma(C_L \times V_{CC}^2 \times f_o)$ = sum of the outputs.

10.1. Waveforms and test circuit



Measurement points are given in [Table 8](#).

Logic levels: V_{OL} and V_{OH} are typical output voltage levels that occur with the output load.

Fig. 6. The input (nAn) to output (nYn) propagation delays

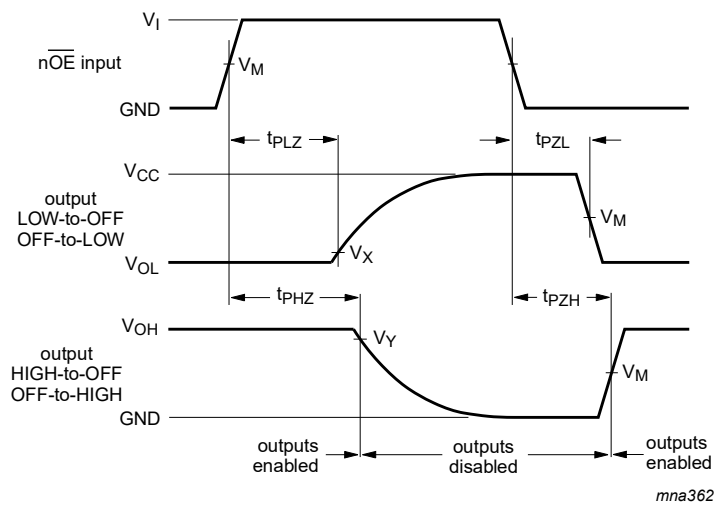

Measurement points are given in [Table 8](#).

Logic levels: V_{OL} and V_{OH} are typical output voltage levels that occur with the output load.

Fig. 7. 3-state enable and disable times

Table 8. Measurement points

Supply voltage	Input		Output		
V_{CC}	V_I	V_M	V_M	V_X	V_Y
1.2 V	V_{CC}	$0.5 \times V_{CC}$	$0.5 \times V_{CC}$	$V_{OL} + 0.15 \text{ V}$	$V_{OH} - 0.15 \text{ V}$
1.65 V to 1.95 V	V_{CC}	$0.5 \times V_{CC}$	$0.5 \times V_{CC}$	$V_{OL} + 0.15 \text{ V}$	$V_{OH} - 0.15 \text{ V}$
2.3 V to 2.7 V	V_{CC}	$0.5 \times V_{CC}$	$0.5 \times V_{CC}$	$V_{OL} + 0.15 \text{ V}$	$V_{OH} - 0.15 \text{ V}$
2.7 V	2.7 V	1.5 V	1.5 V	$V_{OL} + 0.3 \text{ V}$	$V_{OH} - 0.3 \text{ V}$
3.0 V to 3.6 V	2.7 V	1.5 V	1.5 V	$V_{OL} + 0.3 \text{ V}$	$V_{OH} - 0.3 \text{ V}$

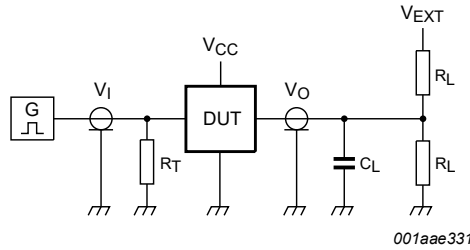
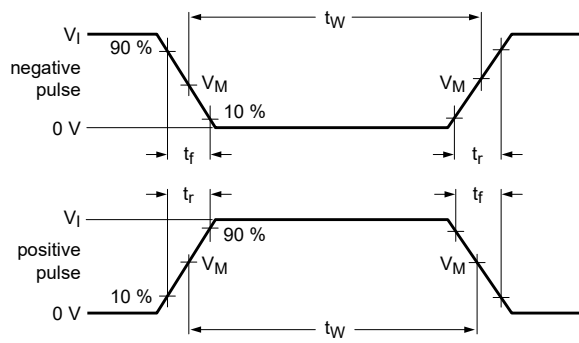

Test data is given in [Table 9](#).

Definitions for test circuit:

R_L = Load resistance.

C_L = Load capacitance including jig and probe capacitance.

R_T = Termination resistance should be equal to output impedance Z_o of the pulse generator.

V_{EXT} = External voltage for measuring switching times.

Fig. 8. Test circuit for measuring switching times

Table 9. Test data

Supply voltage	Input		Load		V_{EXT}		
	V_I	t_r, t_f	C_L	R_L	t_{PLH}, t_{PHL}	t_{PLZ}, t_{PZL}	t_{PHZ}, t_{PZH}
1.2 V	V_{CC}	≤ 2 ns	30 pF	1 k Ω	open	$2 \times V_{CC}$	GND
1.65 V to 1.95 V	V_{CC}	≤ 2 ns	30 pF	1 k Ω	open	$2 \times V_{CC}$	GND
2.3 V to 2.7 V	V_{CC}	≤ 2 ns	30 pF	500 Ω	open	$2 \times V_{CC}$	GND
2.7 V	2.7 V	≤ 2.5 ns	50 pF	500 Ω	open	$2 \times V_{CC}$	GND
3.0 V to 3.6 V	2.7 V	≤ 2.5 ns	50 pF	500 Ω	open	$2 \times V_{CC}$	GND

11. Package outline

SO20: plastic small outline package; 20 leads; body width 7.5 mm

SOT163-1



Fig. 9. Package outline SOT163-1 (SO20)

SSOP20: plastic shrink small outline package; 20 leads; body width 5.3 mm

SOT339-1

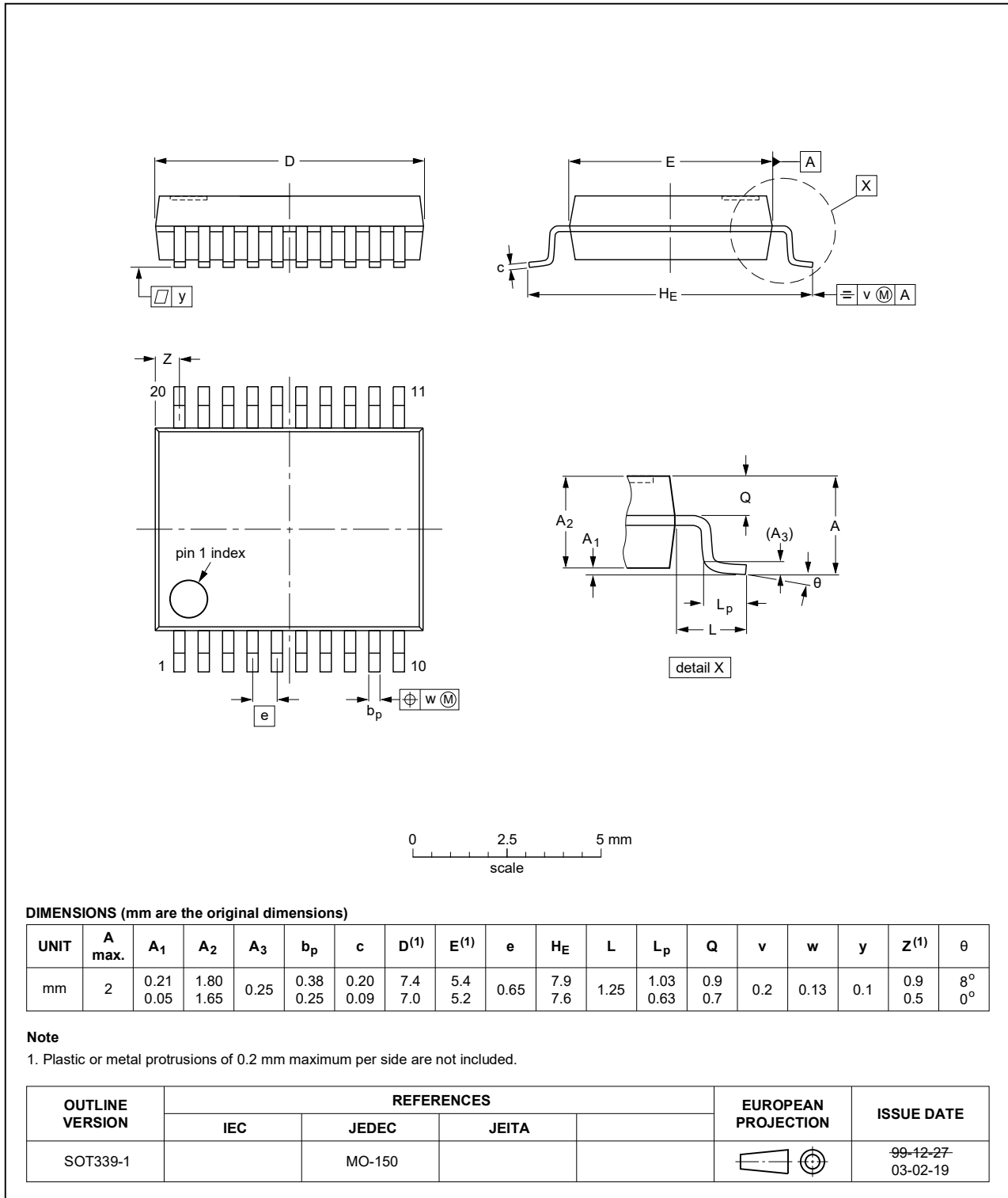

Fig. 10. Package outline SOT339-1 (SSOP20)

TSSOP20: plastic thin shrink small outline package; 20 leads; body width 4.4 mm

SOT360-1



Fig. 11. Package outline SOT360-1 (TSSOP20)

DHVQFN20: plastic dual in-line compatible thermal enhanced very thin quad flat package; no leads; 20 terminals; body 2.5 x 4.5 x 0.85 mm

SOT764-1



Fig. 12. Package outline SOT764-1 (DHVQFN20)

12. Abbreviations

Table 10. Abbreviations

Acronym	Description
CMOS	Complementary Metal-Oxide Semiconductor
DUT	Device Under Test
ESD	ElectroStatic Discharge
HBM	Human Body Model
MIL	Military
MM	Machine Model
TTL	Transistor-Transistor Logic

13. Revision history

Table 11. Revision history

Document ID	Release date	Data sheet status	Change notice	Supersedes
74LVC_LVCH244A_Q100 v.5	20200408	Product data sheet	-	74LVC_LVCH244A_Q100 v.4
Modifications:	<ul style="list-style-type: none"> Section 2 updated. 			
74LVC_LVCH244A_Q100 v.4	20190722	Product data sheet	-	74LVC_LVCH244A_Q100 v.3
Modifications:	<ul style="list-style-type: none"> Type number 74LVCH244AD-Q100 (SOT163-1) added. Type number 74LVCH244ADB-Q100 (SOT339-1) added. Type number 74LVCH244ABQ-Q100 (SOT764-1) added. Table 4: Derating values for P_{tot} total power dissipation have changed. 			
74LVC_LVCH244A_Q100 v.3	20180813	Product data sheet	-	74LVC_LVCH244A_Q100 v.2
Modifications:	<ul style="list-style-type: none"> The format of this data sheet has been redesigned to comply with the identity guidelines of Nexperia. Legal texts have been adapted to the new company name where appropriate. Type number 74LVCH244AD-Q100 (SOT163-1) removed. Type numbers 74LVC244ADB-Q100 and 74LVCH244ADB-Q100 (SOT339-1) removed. Type number 74LVCH244ABQ-Q100 (SOT764-1) removed. 			
74LVC_LVCH244A_Q100 v.2	20130813	Product data sheet	-	74LVC_LVCH244A_Q100 v.1
Modifications:	<ul style="list-style-type: none"> 74LVC244ADB-Q100 and 74LVCH244DB-Q100 added. 			
74LVC_LVCH244A_Q100 v.1	20120823	Product data sheet	-	-

14. Legal information

Data sheet status

Document status [1][2]	Product status [3]	Definition
Objective [short] data sheet	Development	This document contains data from the objective specification for product development.
Preliminary [short] data sheet	Qualification	This document contains data from the preliminary specification.
Product [short] data sheet	Production	This document contains the product specification.

- [1] Please consult the most recently issued document before initiating or completing a design.
- [2] The term 'short data sheet' is explained in section "Definitions".
- [3] The product status of device(s) described in this document may have changed since this document was published and may differ in case of multiple devices. The latest product status information is available on the internet at <https://www.nexperia.com>.

Definitions

Draft — The document is a draft version only. The content is still under internal review and subject to formal approval, which may result in modifications or additions. Nexperia does not give any representations or warranties as to the accuracy or completeness of information included herein and shall have no liability for the consequences of use of such information.

Short data sheet — A short data sheet is an extract from a full data sheet with the same product type number(s) and title. A short data sheet is intended for quick reference only and should not be relied upon to contain detailed and full information. For detailed and full information see the relevant full data sheet, which is available on request via the local Nexperia sales office. In case of any inconsistency or conflict with the short data sheet, the full data sheet shall prevail.

Product specification — The information and data provided in a Product data sheet shall define the specification of the product as agreed between Nexperia and its customer, unless Nexperia and customer have explicitly agreed otherwise in writing. In no event however, shall an agreement be valid in which the Nexperia product is deemed to offer functions and qualities beyond those described in the Product data sheet.

Disclaimers

Limited warranty and liability — Information in this document is believed to be accurate and reliable. However, Nexperia does not give any representations or warranties, expressed or implied, as to the accuracy or completeness of such information and shall have no liability for the consequences of use of such information. Nexperia takes no responsibility for the content in this document if provided by an information source outside of Nexperia.

In no event shall Nexperia be liable for any indirect, incidental, punitive, special or consequential damages (including - without limitation - lost profits, lost savings, business interruption, costs related to the removal or replacement of any products or rework charges) whether or not such damages are based on tort (including negligence), warranty, breach of contract or any other legal theory.

Notwithstanding any damages that customer might incur for any reason whatsoever, Nexperia's aggregate and cumulative liability towards customer for the products described herein shall be limited in accordance with the Terms and conditions of commercial sale of Nexperia.

Right to make changes — Nexperia reserves the right to make changes to information published in this document, including without limitation specifications and product descriptions, at any time and without notice. This document supersedes and replaces all information supplied prior to the publication hereof.

Suitability for use in automotive applications — This Nexperia product has been qualified for use in automotive applications. Unless otherwise agreed in writing, the product is not designed, authorized or warranted to be suitable for use in life support, life-critical or safety-critical systems or

equipment, nor in applications where failure or malfunction of an Nexperia product can reasonably be expected to result in personal injury, death or severe property or environmental damage. Nexperia and its suppliers accept no liability for inclusion and/or use of Nexperia products in such equipment or applications and therefore such inclusion and/or use is at the customer's own risk.

Quick reference data — The Quick reference data is an extract of the product data given in the Limiting values and Characteristics sections of this document, and as such is not complete, exhaustive or legally binding.

Applications — Applications that are described herein for any of these products are for illustrative purposes only. Nexperia makes no representation or warranty that such applications will be suitable for the specified use without further testing or modification.

Customers are responsible for the design and operation of their applications and products using Nexperia products, and Nexperia accepts no liability for any assistance with applications or customer product design. It is customer's sole responsibility to determine whether the Nexperia product is suitable and fit for the customer's applications and products planned, as well as for the planned application and use of customer's third party customer(s). Customers should provide appropriate design and operating safeguards to minimize the risks associated with their applications and products.

Nexperia does not accept any liability related to any default, damage, costs or problem which is based on any weakness or default in the customer's applications or products, or the application or use by customer's third party customer(s). Customer is responsible for doing all necessary testing for the customer's applications and products using Nexperia products in order to avoid a default of the applications and the products or of the application or use by customer's third party customer(s). Nexperia does not accept any liability in this respect.

Limiting values — Stress above one or more limiting values (as defined in the Absolute Maximum Ratings System of IEC 60134) will cause permanent damage to the device. Limiting values are stress ratings only and (proper) operation of the device at these or any other conditions above those given in the Recommended operating conditions section (if present) or the Characteristics sections of this document is not warranted. Constant or repeated exposure to limiting values will permanently and irreversibly affect the quality and reliability of the device.

Terms and conditions of commercial sale — Nexperia products are sold subject to the general terms and conditions of commercial sale, as published at <http://www.nexperia.com/profile/terms>, unless otherwise agreed in a valid written individual agreement. In case an individual agreement is concluded only the terms and conditions of the respective agreement shall apply. Nexperia hereby expressly objects to applying the customer's general terms and conditions with regard to the purchase of Nexperia products by customer.

No offer to sell or license — Nothing in this document may be interpreted or construed as an offer to sell products that is open for acceptance or the grant, conveyance or implication of any license under any copyrights, patents or other industrial or intellectual property rights.

Export control — This document as well as the item(s) described herein may be subject to export control regulations. Export might require a prior authorization from competent authorities.

Translations — A non-English (translated) version of a document is for reference only. The English version shall prevail in case of any discrepancy between the translated and English versions.

Trademarks

Notice: All referenced brands, product names, service names and trademarks are the property of their respective owners.

Contents

1. General description	1
2. Features and benefits	1
3. Ordering information	2
4. Functional diagram	2
5. Pinning information	3
5.1. Pinning.....	3
5.2. Pin description.....	4
6. Functional description	4
7. Limiting values	4
8. Recommended operating conditions	5
9. Static characteristics	5
10. Dynamic characteristics	7
10.1. Waveforms and test circuit.....	8
11. Package outline	10
12. Abbreviations	14
13. Revision history	14
14. Legal information	15

© Nexperia B.V. 2020. All rights reserved

For more information, please visit: <http://www.nexperia.com>

For sales office addresses, please send an email to: salesaddresses@nexperia.com

Date of release: 8 April 2020
