

## Common Mode Noise Filter NFG0QHB□□□HS2□

## Reference Specification

### 1. Scope

This reference specification applies to Common Mode Noise Filter NFG0QHB□□□HS2□ Series for differential signal interface in Electronics.

### 2. Part Numbering

(Ex.)

NF	G	0Q	HB	242	H	S	2	D
Product ID	Type	Dimension (L × W)	Application and characteristic	*Resonant frequency	Performance	Category	Number of line	Packaging D: taping *B: bulk

\*Resonant frequency (MHz)

The first and second figures are significant digits, and the third figure expresses the number of zeros that follow the two figures.

\*B: Bulk packing is also available.

### 3. Part Number and Rating

Operating temperature range	-40°C to +85°C
Storage temperature range	-40°C to +85°C

Customer Part Number	MURATA Part Number	Common Mode Impedance (Ω) at 100MHz Typ.	Rated Voltage (VDC)	Withstanding Voltage (VDC)	Rated Current (mA)	DC Resistance (Ω)	Insulation Resistance (MΩ min.)
	NFG0QHB242HS2D	15	5	12.5	100	2.5±25%	100
	NFG0QHB372HS2D	9	5	12.5	100	1.9±25%	100
	NFG0QHB542HS2D	5	5	12.5	100	1.3±25%	100

MURATA Part Number	Common Mode Insertion Loss Characteristic (dB) Typ.			Cut off Frequency (GHz) Typ.
	2.4 GHz	3.7 GHz	5.4 GHz	
NFG0QHB242HS2D	33	-	-	8
NFG0QHB372HS2D	-	30	-	11
NFG0QHB542HS2D	-	-	27	18

### 4. Testing Conditions

Unless otherwise specified	Temperature: ordinary temperature (15°C to 35°C) Humidity: ordinary humidity [25% to 85% (RH)]
In case of doubt	Temperature: 20°C±2°C Humidity: 60% to 70% (RH) Atmospheric pressure: 86 kPa to 106 kPa

## 5. Style and Dimensions

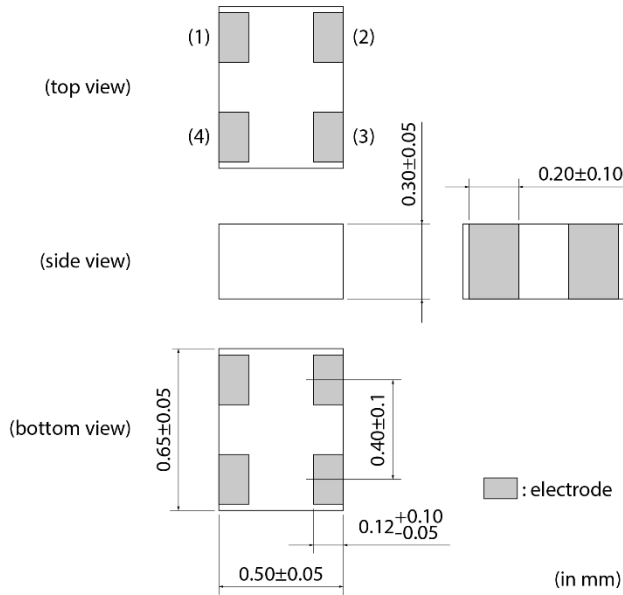

### ■ Equivalent Circuits

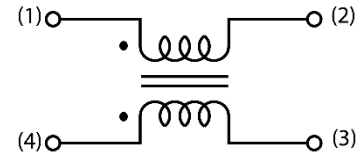

No Polarity.

### ■ Unit Mass(Typical value) 0.0003g

## 6. Marking

No marking.

## 7. Electrical Performance

No.	Item	Specification	Test Method
7.1	Common Mode Impedance	Meet item 3.	Measuring Frequency : $100 \pm 1$ MHz Measuring Equipment : KEYSIGHT4991A or the equivalents (In case of doubt in standard condition, the heat treatment( $200^{\circ}\text{C}$ , about 10 minutes) shall be applied. (ref.item 16.)
7.2	Withstanding Voltage	Products shall not be damaged.	Test Voltage : 2.5 times for Rated Voltage Time : 1 to 5 s Charge Current : 1 mA max. (ref.item 16.)
7.3	DC Resistance	Meet item 3.	Measuring current : 20mA max. (ref.item 16.)
7.4	Insulation Resistance	Meet item 3.	Measuring voltage : Rated Voltage Measuring time : 3 s max. (ref.item 16.)

# Reference Only

Spec No. JEFL243D-0012-01

P3/11

## 8. Mechanical Performance

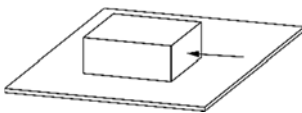
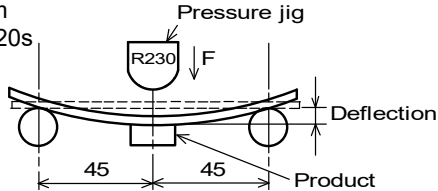
No.	Item	Specification	Test Method
8.1	Bonding Strength	Products shall not be damaged after tested as test method.	It shall be soldered on the 6 Layer substrate (t0.8mm). Applying Force: 2N Applying Time : 5s 
8.2	Bending Strength	Products shall not be damaged after tested as test method.	It shall be soldered on the 6 Layer substrate (t0.8mm). Test substrate: glass-epoxy substrate (100 mm × 40 mm × 0.8 mm) Speed of Applying Force : 1.0mm/s Deflection : 2mm Keeping Time : 20s 
8.3	Vibration	Appearance: No damage	It shall be soldered on the 6 Layer substrate (t0.8mm). Oscillation Frequency : 10Hz to 2000Hz to 10Hz for 20min Total amplitude 3.0mm or Acceleration amplitude 196 m/s <sup>2</sup> whichever is smaller. Testing Time : A period of 2h in each of 3 mutually perpendicular directions.(Total 6h)
8.4	Solderability	The electrodes shall be at least 95% covered with new solder coating.	Flux : Ethanol solution of rosin,25(wt)% Pre-Heating : 150°C, 60s Solder : Sn-3.0Ag-0.5Cu Solder Temperature : 245°C±3°C Immersion Time : 3s

## 9. Environmental Performance

It shall be soldered on the 6 Layer substrate (t0.8mm).

Test shall be done using P.C.B., Flux, Solder and Soldering condition which are specified in item 12 except the case of being specified special condition.

No.	Item	Specification	Test Method								
9.1	Heat Life	Meet Table 1. <u>Table 1</u>	Temperature : 85°C±2°C Applying Current : Rated Current Time : 1000h(+48h,-0h) Then measured after exposure in the room condition for 4 to 48 h. (ref.item 16.)								
9.2	Cold Resistance	<table border="1" style="width: 100%;"> <tr> <td>Appearance</td> <td>No damaged</td> </tr> <tr> <td>Common Mode Impedance Change</td> <td>Within ± 20%</td> </tr> <tr> <td>I.R.</td> <td>100MΩ min.</td> </tr> <tr> <td>DC Resistance Change</td> <td>Within ± 30%</td> </tr> </table>	Appearance	No damaged	Common Mode Impedance Change	Within ± 20%	I.R.	100MΩ min.	DC Resistance Change	Within ± 30%	Temperature : -40°C±2°C Time : 1000h(+48h,-0h) Then measured after exposure in the room condition for 4 to 48 h.
Appearance	No damaged										
Common Mode Impedance Change	Within ± 20%										
I.R.	100MΩ min.										
DC Resistance Change	Within ± 30%										
9.3	Humidity		Temperature : 40°C±2°C Humidity : 90%(RH) to 95%(RH) Time : 1000h(+48h,-0h) Then measured after exposure in the room condition for 4 to 48 h.								
9.4	Temperature Cycle		1 cycle : 1 step : -40 °C(+0 °C,-3 °C) /30min(+3min,-0min) 2 step : Ordinary temp. / 3 min max. 3 step : +85 °C(+3 °C,-0 °C) / 30min(+3min,-0min) 4 step : Ordinary temp. / 3 min max. Total of 100 cycles Then measured after exposure in the room condition for 4 to 48 h.								

## 10. Specification of Packaging

### 10.1 Appearance and Dimensions ( 8mm-wide, 2mm pitch paper tape)

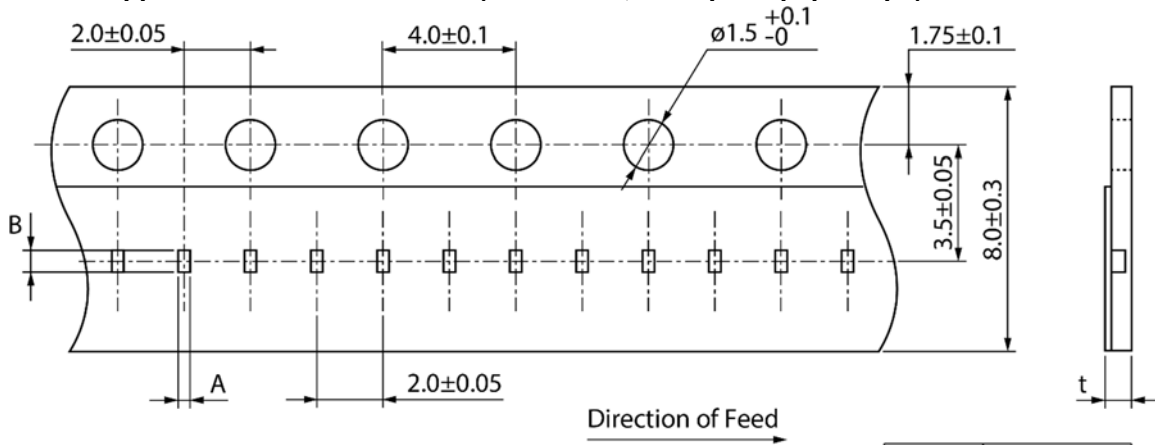

■ Top view

A	(0.60)
B	(0.73)
t	0.55 max.

(in mm)

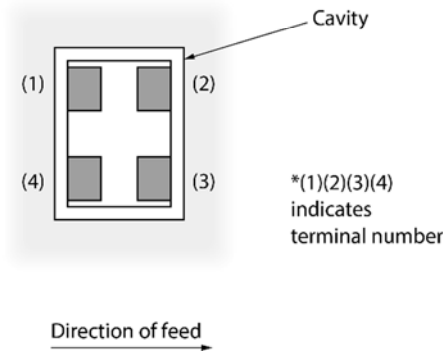

### 10.2 Taping specifications

Packing quantity (Standard quantity)	15000 pcs/reel
Packing method	The products are placed in embossed cavities of a base tape and sealed by a cover tape.
Feed hole position	The feed holes on the base tape are on the right side when the cover tape is pulled toward the user.
Joint	The base tape and the cover tape are seamless.
Number of missing products	Number of missing products within 0.1% of the number per reel or 1 pc., whichever is greater, and are not continuous. The specified quantity per reel is kept.

### 10.3 Break down force of tape

Break down force of cover tape	5 N min.
--------------------------------	----------

### 10.4 Peeling off force of cover tape

Speed of peeling off	300 mm/min
Peeling off force	0.1 N to 0.7 N (The lower limit is for typical value.)

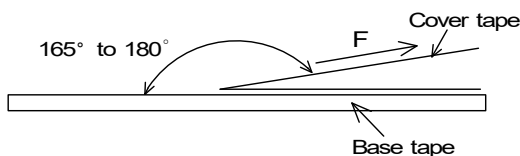

# Reference Only

Spec No. JEFL243D-0012-01

P5/11

## 10.5 Dimensions of leader section, trailer section and reel

A vacant section is provided in the leader (start) section and trailer (end) section of the tape for the product. The leader section is further provided with an area consisting only of the cover tape. (See the diagram below.)

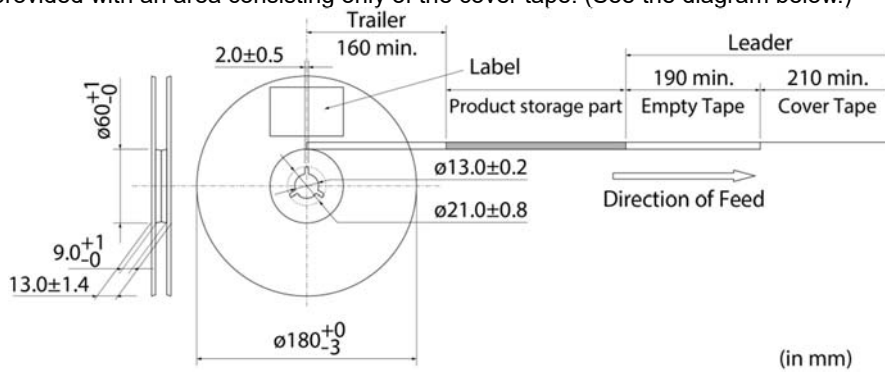

## 10.6 Marking for reel

Customer part number, Murata part number, inspection number (\*1), RoHS marking (\*2), quantity, etc.

<p>*1 Expression of inspection No.:</p> <table style="width: 100%; border-collapse: collapse;"> <tr> <td style="text-align: center; border: 1px solid black;">□□</td> <td style="text-align: center; border: 1px solid black;">○○○○</td> <td style="text-align: center; border: 1px solid black;">◇◇◇◇</td> </tr> <tr> <td style="text-align: center;">(1)</td> <td style="text-align: center;">(2)</td> <td style="text-align: center;">(3)</td> </tr> </table>	□□	○○○○	◇◇◇◇	(1)	(2)	(3)	<p>(1) Factory code (2) Date First digit: year/last digit of year Second digit: month/Jan. to Sep. → 1 to 9, Oct. to Dec. → O, N, D Third, Fourth digit: day (3) Serial No.</p>
□□	○○○○	◇◇◇◇					
(1)	(2)	(3)					
<p>*2 Expression of RoHS marking:</p> <table style="width: 100%; border-collapse: collapse;"> <tr> <td style="text-align: center; border: 1px solid black;">ROHS- Y</td> <td style="text-align: center; border: 1px solid black;">(△)</td> </tr> <tr> <td style="text-align: center;">(1)</td> <td style="text-align: center;">(2)</td> </tr> </table>	ROHS- Y	(△)	(1)	(2)	<p>(1) RoHS regulation conformity (2) Murata classification number</p>		
ROHS- Y	(△)						
(1)	(2)						

## 10.7 Marking on outer box (corrugated box)

Customer name, purchasing order number, customer part number, Murata part number, RoHS marking (\*2), quantity, etc.

## 10.8 Specification of outer box

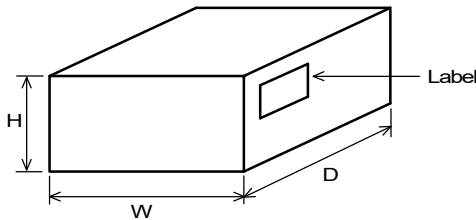

Dimensions of outer box (mm)			Standard reel quantity in outer box (reel)
W	D	H	
186	186	93	5
* Above outer box size is typical. It depends on a quantity of an order.			

## 11. ⚠Caution

### 11.1 Restricted applications

Please contact us before using our products for the applications listed below which require especially high reliability for the prevention of defects which might directly cause damage to the third party's life, body or property.

- |                                   |   |
|-----------------------------------|---|
| (1) Aircraft equipment            | (6) Transportation equipment (vehicles, trains, ships, etc.)  |
| (2) Aerospace equipment           | (7) Traffic signal equipment  |
| (3) Undersea equipment            | (8) Disaster/crime prevention equipment   |
| (4) Power plant control equipment | (9) Data-processing equipment   |
| (5) Medical equipment             | (10) Applications of similar complexity and/or reliability requirements to the applications listed in the above |

### 11.2 Precautions on rating

Do not use over the rated temperature range, rated voltage, or rated current.  
If used beyond the rating, serious defects such as wire breakage and burnout may occur.

### 11.3 Mounting Direction

Mount products in right direction.

Wrong direction which is 90° rotated from right direction causes not only open or short circuit but also flames or other serious trouble.

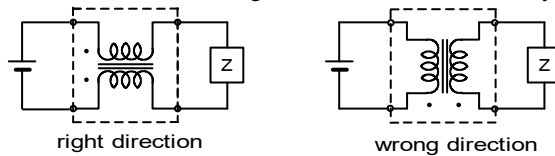

## 12. Precautions for Use

This product is designed for solder mounting. (reflow soldering only)

Please consult us in advance for applying other mounting method such as conductive adhesive.

### 12.1 Land dimensions

The following diagram shows the recommended land dimensions for reflow soldering.

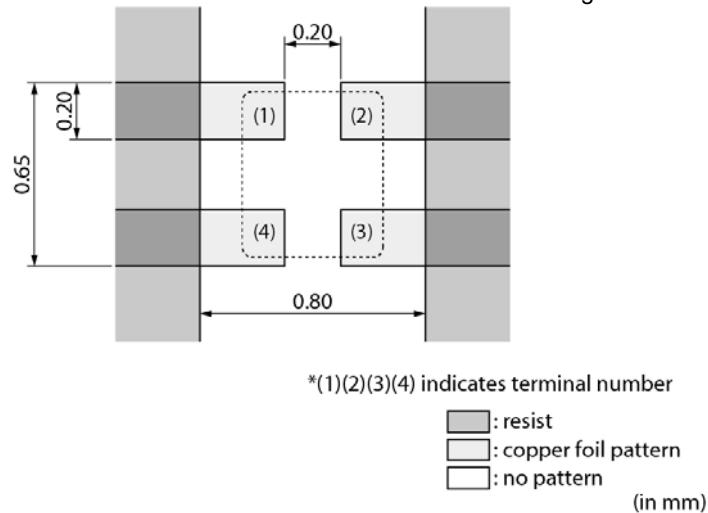

### 12.2 Flux and solder used

Flux	<ul style="list-style-type: none"> <li>• Use a rosin-based flux.</li> <li>• Do not use a highly acidic flux with a halide content exceeding 0.2(wt)% (chlorine conversion value).</li> <li>• Do not use a water-soluble flux.</li> </ul>
Solder	<ul style="list-style-type: none"> <li>• Use Sn-3.0Ag-0.5Cu solder.</li> <li>• Standard thickness of solder paste: 80 μm</li> </ul>

If you want to use a flux other than the above, please consult our technical department.

### 12.3 Soldering conditions (reflow)

- Pre-heating should be in such a way that the temperature difference between solder and product surface is limited to

100°C max.

Cooling into solvent after soldering also should be in such a way that the temperature difference is limited to 100°C max.

Insufficient pre-heating may cause cracks on the product, resulting in the deterioration of product quality.

- Standard soldering profile and the limit soldering profile is as follows.

The excessive limit soldering conditions may cause leaching of the electrode and/or resulting in the deterioration of product quality.

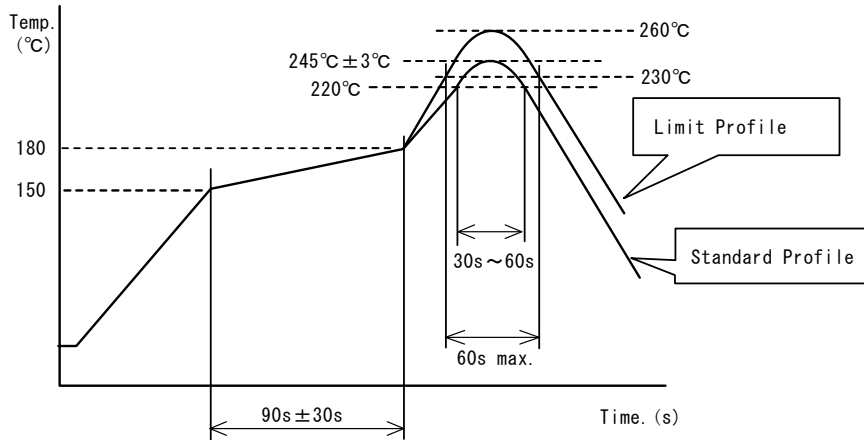

	Standard profile	Limit profile
Pre-heating	150°C to 180°C/90 s±30 s	150°C to 180°C/90 s±30 s
Heating	Above 220°C/30 s to 60 s	Above 230°C/60 s max.
Peak temperature	245°C±3°C	260°C/10 s
Number of reflow cycles	2 times	2 times

### 12.4 Reworking with soldering iron

The following requirements must be met to rework a soldered product using a soldering iron.

Item	Requirement
Pre-heating	150°C/approx. 1 min
Tip temperature of soldering iron	380°C max.
Power consumption of soldering iron	30 W max.
Tip diameter of soldering iron	ø3 mm max.
Soldering time	3 s (+1 s, -0 s)
Number of reworking operations	2 times max.
* Avoid a direct contact of the tip of the soldering iron with the product. Such a direction contact may cause cracks in the ceramic body due to thermal shock.	

### 12.5 Solder volume

Solder shall be used not to be exceeded the upper limits as shown below.

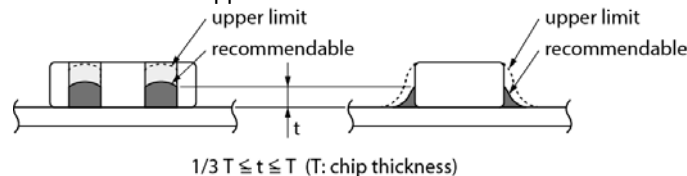

An increased solder volume increases mechanical stress on the product. Exceeding solder volume may cause the failure of mechanical or electrical performance.

### 12.6 Product's location

The following shall be considered when designing and laying out PCBs.

- (1) PCB shall be designed so that products are not subject to mechanical stress due to warping the board.

[Products direction]

Products shall be located in the sideways direction (length:  $a < b$ ) to the mechanical stress.

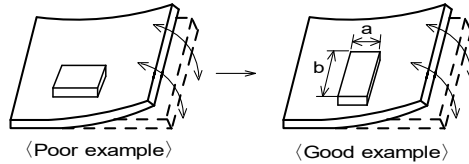

(2) Components location on PCB separation

It is effective to implement the following measures, to reduce stress in separating the board.

It is best to implement all of the following three measures; however, implement as many measures as possible to reduce stress.

Contents of measures	Stress level
(1) Turn the mounting direction of the component parallel to the board separation surface.	$A > D^{*1}$
(2) Add slits in the board separation part.	$A > B$
(3) Keep the mounting position of the component away from the board separation surface.	$A > C$
*1 $A > D$ is valid when stress is added vertically to the perforation as with hand separation. If a cutting disc is used, stress will be diagonal to the PCB, therefore $A > D$ is invalid.	

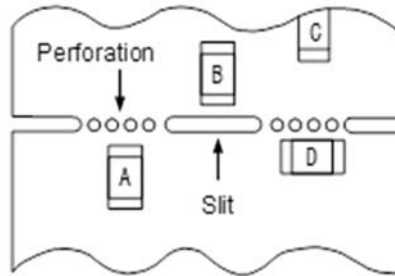

(3) Mounting components near screw holes

When a component is mounted near a screw hole, it may be affected by the board deflection that occurs during the tightening of the screw.

Mount the component in a position as far away from the screw holes as possible.

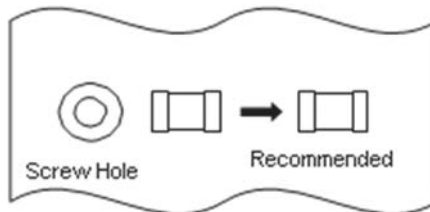

**12.7 Handling of substrate**

After mounting products on a substrate, do not apply any stress to the product caused by bending or twisting to the substrate when cropping the substrate, inserting and removing a connector from the substrate or tightening screw to the substrate.

Excessive mechanical stress may cause cracking in the product.

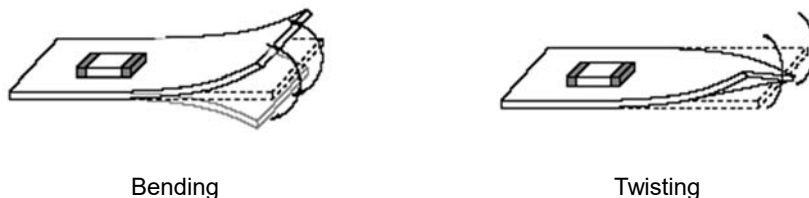

**12.8 Cleaning**

When cleaning this product, observe the following conditions:

- (1) The cleaning temperature shall be 60°C max. If isopropyl alcohol (IPA) is used, the cleaning temperature shall be



40°C max.

(2) During ultrasonic cleaning, under some cleaning conditions, the resonation of PCB should be caused by its vibration. Be sure to do the test cleaning with actual cleaning equipment before production and confirm that product does not be damaged by cleaning.

(3) Cleaner

Alcohol-based cleaner: IPA

Aqueous agent: PINE ALPHA ST-100S

(4) There shall be no residual flux or residual cleaner. When using aqueous agent, rinse the product with deionized water adequately and completely dry it so that no cleaner is left.

\* For other cleaning, consult our technical department.

## 12.9 Storage and transportation

Storage period	Use the product within 6 months after delivery. If you do not use the product for more than 6 months, check solderability before using it.
Storage conditions	<ul style="list-style-type: none"> <li>• The products shall be stored in a room not subject to rapid changes in temperature and humidity. The recommended temperature range is -10°C to +40°C. The recommended relative humidity range is 15% to 85%. Keeping the product in corrosive gases, such as sulfur, chlorine gas or acid may cause the poor solderability.</li> <li>• Do not place the products directly on the floor; they should be placed on a palette so that they are not affected by humidity or dust.</li> <li>• Avoid keeping the products in a place exposed to direct sunlight, heat or vibration.</li> <li>• Do not keep products in bulk packaging. Doing so may cause collision between the products or between the products and other products, resulting in chipping or wire breakage.</li> <li>• Avoid storing the product by itself bare (i.e. exposed directly to air).</li> </ul>
Transportation	Excessive vibration and impact reduces the reliability of the products. Exercise caution when handling the products.

## 12.10 Resin coating (including moistureproof coating)

Coating/molding the product with resin may change electrical characteristics.

A wire breakage issue may occur by mechanical stress caused by the resin, amount/cured shape of resin, or operating condition etc. Some resin contains some impurities or chloride possible to generate chlorine by hydrolysis under some operating condition may cause corrosion of conductor, leading to wire breakage.

Prior to use the coating resin, please make sure no reliability issue is observed by evaluating products mounted on your board.

## 12.11 Mounting Conditions

- Please check the mounting condition before using.
- Using mounting conditions (nozzles, equipment conditions, etc.) that are not suitable for products may lead to pick up errors, misalignment, or damage to the product.

## 12.12 Operating Environment

Do not use this product under the following environmental conditions, on deterioration of the performance, such as insulation resistance may result from the use.

- (1) in the corrodible atmosphere such as acidic gases, alkaline gases, chlorine, sulfur gases, organic gases and etc.  
(the sea breeze, Cl<sub>2</sub>, H<sub>2</sub>S, NH<sub>3</sub>, SO<sub>2</sub>, NO<sub>2</sub>, etc)
- (2) in the atmosphere where liquid such as organic solvent, may splash on the products.

### 13. Note

- (1) Please make sure that your product has been evaluated in view of your specifications with our product being mounted to your product.
- (2) You are requested not to use our product deviating from the agreed specifications.
- (3) The contents of this reference specification are subject to change without advance notice. Please approve our product specifications or transact the approval sheet for product specifications before ordering.

## 14. Appendix

<Measurement method>

### ■ Terminal to be Tested.

When measuring and supplying the voltage(or the current),the following terminal is applied.

No.	Item	Terminal to be Tested
7.1	Common Mode Impedance (Measurement Terminal)	
7.2	Withstanding Voltage (Supply Terminal)	
7.3	DC Resistance (Measurement Terminal)	
7.4	Insulation Resistance (Measurement Terminal)	
9.1	Heat Life (Supply Terminal)	

### ■ Measuring method for common mode impedance.

Measured common mode impedance may be included measurement error due to stray capacitance, residual inductance of test fixture.

To correct this error, the common mode impedance should be calculate as follows;

- (1) Measure admittance of the fixture(opened),  $G_o \quad B_o$ .
- (2) Measure impedance of the fixture(shorted),  $R_s \quad X_s$ .
- (3) Measure admittance of the specimen,  $G_m \quad B_m$ .
- (4) Calculate corrected impedance  $|Z|$  using the formula below.

$$|Z| = (R_x^2 + X_x^2)^{1/2}$$

Where

$$R_x = \frac{G_m - G_o}{(G_m - G_o)^2 + (B_m - B_o)^2} - R_s$$

$$X_x = \frac{-(B_m - B_o)}{(G_m - G_o)^2 + (B_m - B_o)^2} - X_s$$