

# Chip Multilayer Ceramic Capacitors for Automotive



2019



### **EU RoHS Compliant**

- All the products in this catalog comply with EU RoHS.
- EU RoHS is "the European Directive 2011/65/EU on the Restriction of the Use of Certain Hazardous Substances in Electrical and Electronic Equipment."
- For more details, please refer to our web page, "Murata's Approach for EU RoHS" (<https://www.murata.com/en-eu/support/compliance/rohs>).

# Contents

Product specifications are as of October 2019.

Explanation of Symbols in This Catalog .....	p2	
Selection Guide for Capacitors .....	p3	
Catalog Information .....	p4	
Part Numbering .....	p5	
Capacitance Table .....	p8	<small>Cap. Table</small>
<hr/>		
AEC-Q200 Compliant Chip Multilayer Ceramic Capacitors for Infotainment		
GRT Series .....	p29	p9
<hr/>		
Chip Multilayer Ceramic Capacitors for Automotive		
GCM Series .....	p36	p15
<hr/>		
High Effective Capacitance & High Ripple Current Chip Multilayer Ceramic Capacitors for Automotive		
GC3 Series .....	p43	p19
<hr/>		
Soft Termination Chip Multilayer Ceramic Capacitors for Automotive		
GCJ Series .....	p45	p20
<hr/>		
High Q Chip Multilayer Ceramic Capacitors for Automotive		
GCQ Series .....	p50	p23
<hr/>		
MLSC Design Chip Multilayer Ceramic Capacitors for Automotive		
GCD Series .....	p56	p23
<hr/>		
Soft Termination MLSC Design Chip Multilayer Ceramic Capacitors for Automotive		
GCE Series .....	p58	p24
<hr/>		
Very Large Current 3 Terminals Low ESL Chip Multilayer Ceramic Capacitors for Automotive		
NFM Series .....	p60	p24
<hr/>		
Metal Terminal Type Multilayer Ceramic Capacitors for Automotive		
KCM Series .....	p63	p24
<hr/>		
High Effective Capacitance & High Allowable Ripple Current Metal Terminal Type Multilayer Ceramic Capacitors for Automotive		
KC3 Series .....	p67	p25
<hr/>		
Safety Standard Certified Metal Terminal Type Multilayer Ceramic Capacitors for Automotive		
KCA Series .....	p70	p25
<hr/>		
AgPd Termination Conductive Glue Mounting Chip Multilayer Ceramic Capacitors for Automotive		
GCG Series .....	p73	p25
<hr/>		
⚠Caution/Notice .....	p77	
Web page SimSurfing .....	p99	
Introduction .....	p100	

Please check the MURATA website (<https://www.murata.com/>) if you cannot find a part number in this catalog.

# Explanation of Symbols in This Catalog



Links are provided to the latest information from the PDF version of the catalog, which is available on the web.

<b>General</b>	For applications that do not require the particular reliability such as the general equipment
<b>Info-tainment</b>	Infotainment for Automotive The product for entertainment equipment like car navigations, car audios, and body control equipment like wipers, power windows.
<b>Power-train</b>	Powertrain/Safety for Automotive Product used for applications (running, turning, stopping and safety devices) which particularly concern human life, such as in devices for automobiles.
<b>Medical Device</b>	Medical-grade products for Implanted Medical Devices These products are intended for use in implanted medical devices such as cardiac pacemakers, cochlear implants, insulin pumps and gastric electrostimulators. They are suitable for use in non-critical circuits. *1 *1 Non-critical circuits This term refers to circuits in implanted medical devices that are not directly linked to life support, i.e. circuits that will not directly endanger the life of the patient should the functionality of the device be reduced or halted by failure of the circuit.
<b>AEC-Q200</b>	AEC-Q200 compliant product
<b>Safety standard</b>	Safety Standard Certified Product Products that acquired safety standard certification IEC60384-14 and products based on the Electrical Appliance and Material Safety Law of Japan.
<b>High Q</b>	Low dissipation for high frequency By devising ceramic materials and electrode materials, low dissipation is achieved in frequency bands of VHF, UHF and microwave or beyond.
<b>Low ESL</b>	Low inductance This capacitor is designed so that the parasitic inductance component (ESL) that the capacitor has on the high frequency side becomes lower.
<b>Fail safe</b>	Fail safe product This capacitor is designed to prevent failures as much as possible by short mode.
<b>Deflecting crack</b>	Product resistant to deflection cracking This capacitor is designed to prevent failures as much as possible by short mode caused by cracking when there is board deflection.
<b>Soldering crack</b>	Product with solder cracking suppression This capacitor is configured with metal terminals and leads connected to the chip. The metal terminals and leads relieve the stress from expansion and contraction of the solder, to suppress solder cracking.
<b>Anti-noise</b>	Product suitable for acoustic noise reduction and low distortion This product suppresses acoustic noise, which occurs when a ceramic capacitor is used, by devising the materials and configuration.
<b>Effective Cap</b>	No DC bias characteristics Polymer capacitor is no capacitance change with DC bias due to aluminum oxidized film for dielectric.
<b>EMI Filter</b>	Low-inductance product suitable for noise suppression. This product has extremely low ESL and is suitable for suppression of noise, including high frequencies. This product can also be used as a low-ESL, high-performance bypass capacitor.
<b>Limited to conductive glue mounting</b>	Limited to Conductive Glue Mounting Since silver palladium is used for the external electrodes, the capacitor can be mounted by conductive adhesive.

## Derating 1

This product is suitable when a voltage continuously applied to a capacitor in an operating circuit, is used below (derated) the rated voltage of the capacitor. This model guarantees the test conditions in the endurance test, at a rated voltage x 100% at the maximum operating temperature. A reliability assurance level equivalent to a common product can be secured, by using this product within the voltage and temperature derated conditions recommended in the figure below.

**D1**  
 Derating 1

Recommended Conditions of the Derating Operating Voltage and Temperature

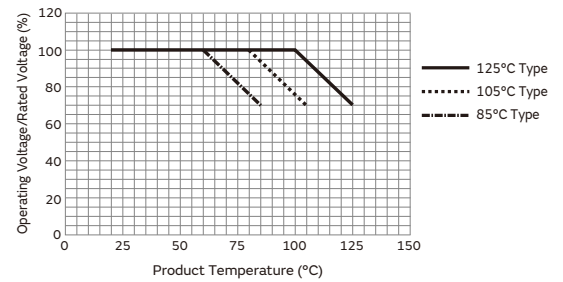

## Derating 2

When the product temperature exceeds 105°C, please use this product within the voltage and temperature derated conditions in the figure below.

**D2**  
 Derating 2

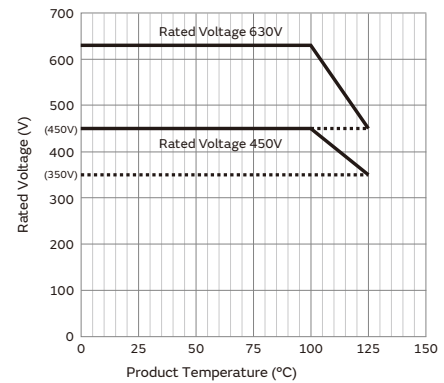

**D3**  
 Derating 3

Derating 3  
 Please apply the derating curve according to the operating temperature.  
 Please refer to detailed specifications sheet for details.

**D4**  
 Derating 4

## Derating 4

When the product temperature exceeds 125°C, please use this product within the voltage and temperature derated conditions in the figure below.

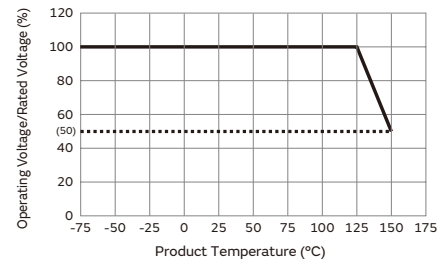

**D5**  
 Derating 5

## Derating 5

Derating 5  
 Please apply the rated voltage derating over 150°C. Please refer to detailed specifications sheet for details.

# Selection Guide for Capacitors

Infotainment for automotive	
Info-entertainment AEC-Q200	SMD Solder mounting Chip type GRT p29

Powertrain/Safety for automotive																																																																																																	
Powertrain AEC-Q200	SMD Solder mounting Chip type <table border="1"> <tr><td>GCM</td><td></td><td></td><td></td><td></td><td>p36</td></tr> <tr><td>GC3</td><td>Anti-noise</td><td></td><td></td><td></td><td>High effective capacitance &amp; high ripple current p43</td></tr> <tr><td>GCJ</td><td>Fail safe</td><td>Deflecting crack</td><td></td><td></td><td>Soft termination p45</td></tr> <tr><td>GCQ</td><td>High Q</td><td></td><td></td><td></td><td>p50</td></tr> <tr><td>GCD</td><td>Fail safe</td><td>Deflecting crack</td><td></td><td></td><td>MLSC design p56</td></tr> <tr><td>GCE</td><td>Fail safe</td><td>Deflecting crack</td><td></td><td></td><td>Soft termination MLSC design p58</td></tr> <tr><td>NFM</td><td>Low ESL</td><td>EMI Filter</td><td></td><td></td><td>3 terminals p60</td></tr> </table> Metal terminal type <table border="1"> <tr><td>KCM</td><td>Anti-noise</td><td>Deflecting crack</td><td>Soldering crack</td><td></td><td>p63</td></tr> <tr><td>KC3</td><td>Anti-noise</td><td>Deflecting crack</td><td>Soldering crack</td><td></td><td>High effective capacitance &amp; high ripple current p67</td></tr> <tr><td>KCA</td><td>Safety standard</td><td>Anti-noise</td><td>Deflecting crack</td><td>Soldering crack</td><td>p70</td></tr> </table> Limited to Conductive Glue Mounting Chip type <table border="1"> <tr><td>GCB</td><td>Deflecting crack</td><td>Soldering crack</td><td></td><td></td><td>Ni plating + Pd plating termination conductive glue mounting WEB</td></tr> <tr><td>GCG</td><td>Deflecting crack</td><td>Soldering crack</td><td></td><td></td><td>AgPd termination conductive glue mounting p73</td></tr> </table> Lead type Solder mounting <table border="1"> <tr><td>RCE</td><td>Anti-noise</td><td>Deflecting crack</td><td>Soldering crack</td><td></td><td>WEB</td></tr> <tr><td>RHE</td><td>Anti-noise</td><td>Deflecting crack</td><td>Soldering crack</td><td></td><td>150°C operation leaded WEB</td></tr> <tr><td>RHS</td><td>Anti-noise</td><td>Deflecting crack</td><td>Soldering crack</td><td></td><td>200°C operation leaded WEB</td></tr> <tr><td>DE6</td><td>Safety standard</td><td></td><td></td><td></td><td>WEB</td></tr> </table>	GCM					p36	GC3	Anti-noise				High effective capacitance & high ripple current p43	GCJ	Fail safe	Deflecting crack			Soft termination p45	GCQ	High Q				p50	GCD	Fail safe	Deflecting crack			MLSC design p56	GCE	Fail safe	Deflecting crack			Soft termination MLSC design p58	NFM	Low ESL	EMI Filter			3 terminals p60	KCM	Anti-noise	Deflecting crack	Soldering crack		p63	KC3	Anti-noise	Deflecting crack	Soldering crack		High effective capacitance & high ripple current p67	KCA	Safety standard	Anti-noise	Deflecting crack	Soldering crack	p70	GCB	Deflecting crack	Soldering crack			Ni plating + Pd plating termination conductive glue mounting WEB	GCG	Deflecting crack	Soldering crack			AgPd termination conductive glue mounting p73	RCE	Anti-noise	Deflecting crack	Soldering crack		WEB	RHE	Anti-noise	Deflecting crack	Soldering crack		150°C operation leaded WEB	RHS	Anti-noise	Deflecting crack	Soldering crack		200°C operation leaded WEB	DE6	Safety standard				WEB
GCM					p36																																																																																												
GC3	Anti-noise				High effective capacitance & high ripple current p43																																																																																												
GCJ	Fail safe	Deflecting crack			Soft termination p45																																																																																												
GCQ	High Q				p50																																																																																												
GCD	Fail safe	Deflecting crack			MLSC design p56																																																																																												
GCE	Fail safe	Deflecting crack			Soft termination MLSC design p58																																																																																												
NFM	Low ESL	EMI Filter			3 terminals p60																																																																																												
KCM	Anti-noise	Deflecting crack	Soldering crack		p63																																																																																												
KC3	Anti-noise	Deflecting crack	Soldering crack		High effective capacitance & high ripple current p67																																																																																												
KCA	Safety standard	Anti-noise	Deflecting crack	Soldering crack	p70																																																																																												
GCB	Deflecting crack	Soldering crack			Ni plating + Pd plating termination conductive glue mounting WEB																																																																																												
GCG	Deflecting crack	Soldering crack			AgPd termination conductive glue mounting p73																																																																																												
RCE	Anti-noise	Deflecting crack	Soldering crack		WEB																																																																																												
RHE	Anti-noise	Deflecting crack	Soldering crack		150°C operation leaded WEB																																																																																												
RHS	Anti-noise	Deflecting crack	Soldering crack		200°C operation leaded WEB																																																																																												
DE6	Safety standard				WEB																																																																																												

Medical-grade products for implanted medical devices	
Medical Device	SMD Solder mounting Chip type GCH WEB

For general																																																																																																																																																																									
General	SMD Solder mounting Chip type <table border="1"> <tr><td>GRM</td><td></td><td></td><td></td><td></td><td>WEB</td></tr> <tr><td>GRM</td><td></td><td></td><td></td><td></td><td>For LCD backlight inverter circuit only WEB</td></tr> <tr><td>GR3</td><td>Anti-noise</td><td></td><td></td><td></td><td>High effective capacitance &amp; high ripple current WEB</td></tr> <tr><td>GRJ</td><td>Deflecting crack</td><td></td><td></td><td></td><td>Soft termination WEB</td></tr> <tr><td>GR4</td><td></td><td></td><td></td><td></td><td>For information devices only WEB</td></tr> <tr><td>GR7</td><td></td><td></td><td></td><td></td><td>For camera flash circuit only WEB</td></tr> <tr><td>GJM</td><td>High Q</td><td></td><td></td><td></td><td>WEB</td></tr> <tr><td>GQM</td><td>High Q</td><td></td><td></td><td></td><td>High power WEB</td></tr> <tr><td>GA2</td><td>Japanese Safety Low</td><td></td><td></td><td></td><td>Based on the Electrical Appliance and Material Safety Law of Japan WEB</td></tr> <tr><td>GA3</td><td>Safety standard</td><td></td><td></td><td></td><td>WEB</td></tr> <tr><td>LLL</td><td>Low ESL</td><td></td><td></td><td></td><td>LW reversed WEB</td></tr> <tr><td>LLA</td><td>Low ESL</td><td></td><td></td><td></td><td>8 terminals WEB</td></tr> <tr><td>LLM</td><td>Low ESL</td><td></td><td></td><td></td><td>10 terminals WEB</td></tr> <tr><td>LLR</td><td>Low ESL</td><td></td><td></td><td></td><td>LW reversed controlled ESR WEB</td></tr> <tr><td>NFM</td><td>Low ESL</td><td>EMI Filter</td><td></td><td></td><td>3 terminals WEB</td></tr> <tr><td>GJ4</td><td>Anti-noise</td><td></td><td></td><td></td><td>Low distortion WEB</td></tr> </table> On interposer board <table border="1"> <tr><td>ZRA</td><td>Anti-noise</td><td></td><td></td><td></td><td>WEB</td></tr> <tr><td>ZRB</td><td>Anti-noise</td><td></td><td></td><td></td><td>WEB</td></tr> </table> Metal terminal type <table border="1"> <tr><td>KRM</td><td>Anti-noise</td><td>Deflecting crack</td><td>Soldering crack</td><td></td><td>WEB</td></tr> <tr><td>KR3</td><td>Anti-noise</td><td>Deflecting crack</td><td>Soldering crack</td><td></td><td>High effective capacitance &amp; high ripple current WEB</td></tr> </table> Resin molding SMD type <table border="1"> <tr><td>DK1</td><td>Safety standard</td><td></td><td></td><td></td><td>WEB</td></tr> </table> Polymer Aluminum Electrolytic Capacitors <table border="1"> <tr><td>ECAS</td><td>Anti-noise</td><td>Deflecting crack</td><td>Effective Cap</td><td></td><td>WEB</td></tr> <tr><td>ECNS</td><td>Anti-noise</td><td>Deflecting crack</td><td>Effective Cap</td><td></td><td>WEB</td></tr> </table> Wire bonding mounting Bonding Chip type <table border="1"> <tr><td>GMA</td><td></td><td></td><td></td><td></td><td>Microchip WEB</td></tr> <tr><td>GMD</td><td></td><td></td><td></td><td></td><td>WEB</td></tr> </table> Lead type Solder mounting <table border="1"> <tr><td>RDE</td><td>Anti-noise</td><td>Deflecting crack</td><td>Soldering crack</td><td></td><td>WEB</td></tr> <tr><td>DE1</td><td>Safety standard</td><td></td><td></td><td></td><td>X1/Y1 Class certified product WEB</td></tr> <tr><td>DE2</td><td>Safety standard</td><td></td><td></td><td></td><td>X1/Y2 Class certified product WEB</td></tr> </table>	GRM					WEB	GRM					For LCD backlight inverter circuit only WEB	GR3	Anti-noise				High effective capacitance & high ripple current WEB	GRJ	Deflecting crack				Soft termination WEB	GR4					For information devices only WEB	GR7					For camera flash circuit only WEB	GJM	High Q				WEB	GQM	High Q				High power WEB	GA2	Japanese Safety Low				Based on the Electrical Appliance and Material Safety Law of Japan WEB	GA3	Safety standard				WEB	LLL	Low ESL				LW reversed WEB	LLA	Low ESL				8 terminals WEB	LLM	Low ESL				10 terminals WEB	LLR	Low ESL				LW reversed controlled ESR WEB	NFM	Low ESL	EMI Filter			3 terminals WEB	GJ4	Anti-noise				Low distortion WEB	ZRA	Anti-noise				WEB	ZRB	Anti-noise				WEB	KRM	Anti-noise	Deflecting crack	Soldering crack		WEB	KR3	Anti-noise	Deflecting crack	Soldering crack		High effective capacitance & high ripple current WEB	DK1	Safety standard				WEB	ECAS	Anti-noise	Deflecting crack	Effective Cap		WEB	ECNS	Anti-noise	Deflecting crack	Effective Cap		WEB	GMA					Microchip WEB	GMD					WEB	RDE	Anti-noise	Deflecting crack	Soldering crack		WEB	DE1	Safety standard				X1/Y1 Class certified product WEB	DE2	Safety standard				X1/Y2 Class certified product WEB
GRM					WEB																																																																																																																																																																				
GRM					For LCD backlight inverter circuit only WEB																																																																																																																																																																				
GR3	Anti-noise				High effective capacitance & high ripple current WEB																																																																																																																																																																				
GRJ	Deflecting crack				Soft termination WEB																																																																																																																																																																				
GR4					For information devices only WEB																																																																																																																																																																				
GR7					For camera flash circuit only WEB																																																																																																																																																																				
GJM	High Q				WEB																																																																																																																																																																				
GQM	High Q				High power WEB																																																																																																																																																																				
GA2	Japanese Safety Low				Based on the Electrical Appliance and Material Safety Law of Japan WEB																																																																																																																																																																				
GA3	Safety standard				WEB																																																																																																																																																																				
LLL	Low ESL				LW reversed WEB																																																																																																																																																																				
LLA	Low ESL				8 terminals WEB																																																																																																																																																																				
LLM	Low ESL				10 terminals WEB																																																																																																																																																																				
LLR	Low ESL				LW reversed controlled ESR WEB																																																																																																																																																																				
NFM	Low ESL	EMI Filter			3 terminals WEB																																																																																																																																																																				
GJ4	Anti-noise				Low distortion WEB																																																																																																																																																																				
ZRA	Anti-noise				WEB																																																																																																																																																																				
ZRB	Anti-noise				WEB																																																																																																																																																																				
KRM	Anti-noise	Deflecting crack	Soldering crack		WEB																																																																																																																																																																				
KR3	Anti-noise	Deflecting crack	Soldering crack		High effective capacitance & high ripple current WEB																																																																																																																																																																				
DK1	Safety standard				WEB																																																																																																																																																																				
ECAS	Anti-noise	Deflecting crack	Effective Cap		WEB																																																																																																																																																																				
ECNS	Anti-noise	Deflecting crack	Effective Cap		WEB																																																																																																																																																																				
GMA					Microchip WEB																																																																																																																																																																				
GMD					WEB																																																																																																																																																																				
RDE	Anti-noise	Deflecting crack	Soldering crack		WEB																																																																																																																																																																				
DE1	Safety standard				X1/Y1 Class certified product WEB																																																																																																																																																																				
DE2	Safety standard				X1/Y2 Class certified product WEB																																																																																																																																																																				

# Catalog Information

Catalog relates to a multilayer ceramic capacitor is below.

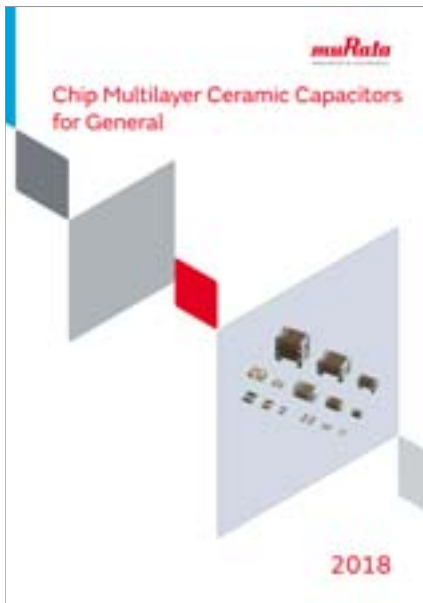

**Chip Multilayer Ceramic Capacitors for General**  
Cat No. C02E-21

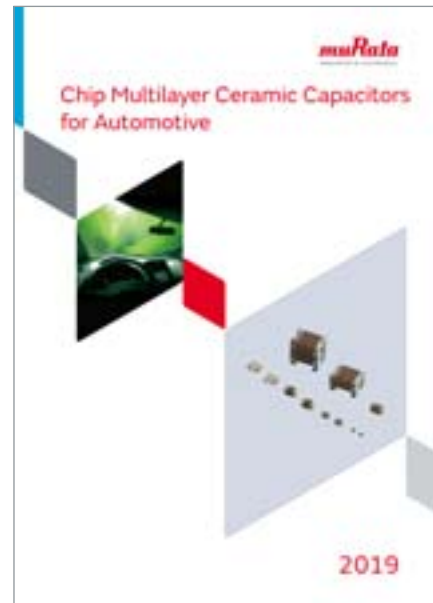

**Chip Multilayer Ceramic Capacitors for Automotive**  
Cat No. C03E-10



**Lead Type Disc Ceramic Capacitors (Safety Standard Certified)**  
**Resin Molding SMD Type Ceramic Capacitors (Safety Standard Certified)**  
Cat No. C85E-7

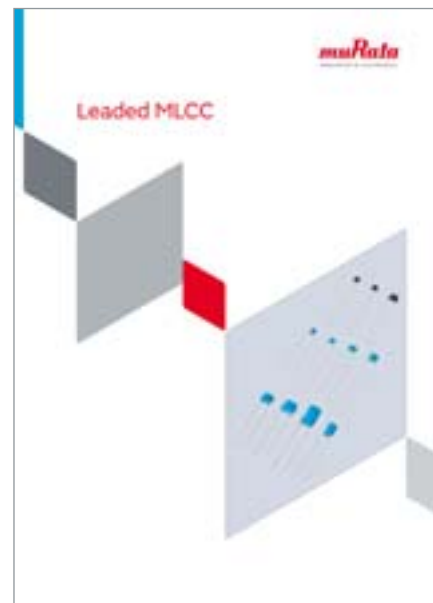

**Ledded MLCC**  
Cat No. C49E-24

● Part Numbering

Chip Multilayer Ceramic Capacitors for Automotive



(Part Number)

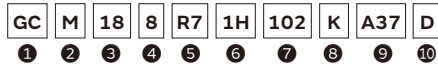

① Product ID

② Series

Product ID	Code	Series
GC	3	High effective capacitance & High allowable ripple current
	D	Specially designed product to reduce shorts
	E	Specially designed product to reduce shorts & resin electrode product
	G	Limited to conductive glue mounting
	J	Soft termination type
	M	For automotive
	Q	High Q Chip Multilayer Ceramic Capacitors for Automotive
GR	T	Meet AEC-Q200 for infotainment
KC	3	Metal terminal type/High effective capacitance & High allowable ripple current
	A	Metel terminal type/ Safety standard certified product
	M	Metal terminal type

③ Chip Dimension (L x W)

Code	Dimension (L x W)	EIA
03	0.6 x 0.3mm	0201
15	1.0 x 0.5mm	0402
18	1.6 x 0.8mm	0603
21	2.0 x 1.25mm	0805
31	3.2 x 1.6mm	1206
32	3.2 x 2.5mm	1210
43	4.5 x 3.2mm	1812
55	5.7 x 5.0mm	2220

⑤ Temperature Characteristics

Temperature Characteristic Codes			Temperature Characteristics			Operating Temperature Range	Capacitance Change Each Temperature (%)					
Code	Public STD Code	Reference Temperature	Temperature Range	Capacitance Change or Temperature Coefficient	-55°C		*4		-10°C			
					Max.		Min.	Max.	Min.	Max.	Min.	
5C	COG	EIA	25°C	25 to 125°C	0±30ppm/°C	-55 to 125°C	0.58	-0.24	0.4	-0.17	0.25	-0.11
5G	X8G	*2	25°C	25 to 150°C	0±30ppm/°C	-55 to 150°C	0.58	-0.24	0.4	-0.17	0.25	-0.11
7U	U2J	EIA	25°C	25 to 125°C *3	-750±120ppm/°C	-55 to 125°C	8.78	5.04	6.04	3.47	3.84	2.21
9E	ZLM	*2	20°C	-55 to -40°C	-4700+1000/-2500ppm/°C	-55 to 125°C	-	-	-	-	-	-
				-40 to 20°C	-5350±750ppm/°C		-	-	-	-	-	
				20 to 85°C	-4700±500ppm/°C		-	-	-	-	-	
				85 to 125°C	-4700+2000/-1000ppm/°C		-	-	-	-	-	
C7	X7S	EIA	25°C	-55 to 125°C	±22%	-55 to 125°C	-	-	-	-	-	-
C8	X6S	EIA	25°C	-55 to 105°C	±22%	-55 to 105°C	-	-	-	-	-	-
D7	X7T	EIA	25°C	-55 to 125°C	+22%, -33%	-55 to 125°C	-	-	-	-	-	-
L8	X8L	*2	25°C	-55 to 150°C	+15%, -40%	-55 to 150°C	-	-	-	-	-	-
M8	X8M	*2	25°C	-55 to 150°C	+15%, -50%	-55 to 150°C	-	-	-	-	-	-
R6	X5R	EIA	25°C	-55 to 85°C	±15%	-55 to 85°C	-	-	-	-	-	-
R7	X7R	EIA	25°C	-55 to 125°C	±15%	-55 to 125°C	-	-	-	-	-	-
R9	X8R	EIA	25°C	-55 to 150°C	±15%	-55 to 150°C	-	-	-	-	-	-

\*1 Capacitance change is specified with 50% rated voltage applied.

\*2 Murata Temperature Characteristic Code.

\*3 Rated Voltage 100Vdc max: 25 to 85°C

\*4 -25°C (Reference Temperature 20°C) / -30°C (Reference Temperature 25°C)

④ Height Dimension (T) (Except KC□)

Code	Dimension (T)
3	0.3mm
5	0.5mm
6	0.6mm
8	0.8mm
9	0.85mm
A	1.0mm
B	1.25mm
C	1.6mm
D	2.0mm
E	2.5mm
M	1.15mm
N	1.35mm
Q	1.5mm
X	Depends on individual standards.

④ Height Dimension (T) (KC□ Only)

Code	Dimension (T)
L	2.8mm
R	3.6mm
Q	3.7mm
T	4.8mm
V	6.2mm
W	6.4mm

Continued on the following page. ↗

(Part Number)

GC	M	18	8	R7	1H	102	K	A37	D
1	2	3	4	5	6	7	8	9	10

Continued from the preceding page. ↘

⑥ Rated Voltage

Code		Rated Voltage
Standard Product	Voltage Derated Product	
0E	-	DC2.5V
0G	-	DC4V
0J	EC	DC6.3V
1A	ED	DC10V
1C	EE	DC16V
1E	EF	DC25V
YA	EG	DC35V
1H	EH	DC50V
1J	-	DC63V
1K	-	DC80V
2A	EL	DC100V
2E	-	DC250V
2W	LP	DC450V
2J	LQ	DC630V
3A	-	DC1kV
MF	-	X1/Y2: AC250V (Safety Standard Certified Type MF)

⑦ Capacitance

Expressed by three-digit alphanumerics. The unit is pico-farad (pF). The first and second figures are significant digits, and the third figure expresses the number of zeros that follow the two numbers.

If there is a decimal point, it is expressed by the capital letter "R."  
 In this case, all figures are significant digits.

If any letter, other than "R" is included, this indicates the specific part number is a non-standard part.

Ex.)

Code	Capacitance
R50	0.50pF
1R0	1.0pF
100	10pF
103	10000pF

⑧ Capacitance Tolerance

Code	Capacitance Tolerance
B	±0.1pF
C	±0.25pF
D	±0.5pF (Less than 10pF)
	±0.5% (10pF and over)
F	±1%
G	±2%
J	±5%
K	±10%
M	±20%
W	±0.05pF

⑨ Individual Specification Code

Expressed by three figures.

⑩ Package

Code	Package
L	ø180mm Embossed Taping
D/W	ø180mm Paper Taping
K	ø330mm Embossed Taping
J	ø330mm Paper Taping

Please contact us if you find any part number not provided in this table.



### 3 Terminal Low ESL Multilayer Ceramic Capacitors



(Part Number)

NF	M	3D	CC	102	R	1H	3	L
①	②	③	④	⑤	⑥	⑦	⑧	⑨

#### ① Product ID ② Series

Product ID	Series
NFM	3 Terminal Low ESL Type

#### ③ Dimensions (LxW)

Code	Dimensions (LxW)	EIA
18	1.6x0.8mm	0603
21	2.0x1.25mm	0805
31	3.2x1.6mm	1206

#### ④ Features

Code	Features	
HC	Powertrain/Safety for Automotive	For Signal Lines / For Large Current
HK		For Very Large Current

#### ⑤ Capacitance

Expressed by three figures. The unit is in pico-farad (pF). The first and second figures are significant digits, and the third figure expresses the number of zeros that follow the two figures.

#### ⑥ Characteristics

Code	Capacitance Temperature Characteristics
C	±22%
R	±15%, +15/-18%

#### ⑦ Rated Voltage

Code	Rated Voltage
0J	6.3V
1A	10V
1C	16V
1H	50V
2A	100V

#### ⑧ Electrode

Code	Electrode
3	Sn Plating

#### ⑨ Packaging

Code	Packaging
L	Embossed Taping (ø180mm Reel)
D	Paper Taping (ø180mm Reel)

Please contact us if you find any part number not provided in this table.

# Capacitance Table

## How to read the Capacitance Table

L×W (mm)	0.6×0.3			1.0×	
T max. (mm)	0.33			0.5	
Rated Voltage (Vdc)	100	50	25	100	50
Cap. / TC Code	COG	COG	COG	COG	CO
1.0pF	p30	p30	p30	p30	p3
2.0pF	p30	p30	p30	p30	p3
3.0pF	p30	p30	p30	p30	p3
4.0pF	p30	p30	p30	p30	p3
5.0pF	p30	p30	p30	p30	p3

→ The values can be narrowed down in the order of size, rated voltage, and temperature characteristics.

→ Refers to the page of the part number list.  
 Check the part number list for the applicable product number.

## Temperature Characteristics Table

The Table is colored by temperature characteristic codes. Refer to the following Table for the meaning of each code.

Temperature Characteristic Codes		Temperature Characteristics			Operating Temperature Range	Capacitance Change Each Temperature (%)					
		Reference Temperature	Temperature Range	Capacitance Change or Temperature Coefficient		-55°C		*3		-10°C	
						Max.	Min.	Max.	Min.	Max.	Min.
COG	EIA	25°C	25 to 125°C	0±30ppm/°C	-55 to 125°C	0.58	-0.24	0.4	-0.17	0.25	-0.11
X8G	*1	25°C	25 to 150°C	0±30ppm/°C	-55 to 150°C	0.58	-0.24	0.4	-0.17	0.25	-0.11
U2J	EIA	25°C	25 to 125°C *2	-750±120ppm/°C	-55 to 125°C	8.78	5.04	6.04	3.47	3.84	2.21
ZLM	*1	20°C	-55 to -40°C	-4700+1000/-2500ppm/°C	-55 to 125°C	-	-	-	-	-	-
			-40 to 20°C	-5350±750ppm/°C		-	-	-	-	-	-
			20 to 85°C	-4700±500ppm/°C		-	-	-	-	-	-
			85 to 125°C	-4700+2000/-1000ppm/°C		-	-	-	-	-	-
X7S	EIA	25°C	-55 to 125°C	±22%	-55 to 125°C	-	-	-	-	-	-
X6S	EIA	25°C	-55 to 105°C	±22%	-55 to 105°C	-	-	-	-	-	-
X7T	EIA	25°C	-55 to 125°C	+22%, -33%	-55 to 125°C	-	-	-	-	-	-
X8L	*1	25°C	-55 to 150°C	+15%, -40%	-55 to 150°C	-	-	-	-	-	-
X8M	*1	25°C	-55 to 150°C	+15%, -50%	-55 to 150°C	-	-	-	-	-	-
X5R	EIA	25°C	-55 to 85°C	±15%	-55 to 85°C	-	-	-	-	-	-
X7R	EIA	25°C	-55 to 125°C	±15%	-55 to 125°C	-	-	-	-	-	-
X8R	EIA	25°C	-55 to 150°C	±15%	-55 to 150°C	-	-	-	-	-	-

\*1 Murata Temperature Characteristic Code.

\*2 Rated Voltage 100Vdc max: 25 to 85°C

\*3 -25°C (Reference Temperature 20°C) / -30°C (Reference Temperature 25°C)

# Capacitance Table

p00 Each number in the Part Number List refers to the page number printed at the bottom of the page.

## GRT Series Temperature Compensating Type

p00 ← Part Number List      EIA: COG

L×W (mm)	0.6×0.3			1.0×0.5			1.6×0.8			2.0×1.25			3.2×1.6				
T max. (mm)	0.33			0.55			0.9			0.6	0.7	1.35	0.95	1.8			
Rated Voltage (Vdc)	100	50	25	100	50	25	100	50	25	25	100	50	100	100	50	25	16
Cap. / TC Code	COG	COG	COG	COG	COG	COG	COG	COG	COG	COG	COG	COG	COG	COG	COG	COG	COG
1.0pF	p30	p30	p30	p30	p31												
2.0pF	p30	p30	p30	p30	p31												
3.0pF	p30	p30	p30	p30	p31												
4.0pF	p30	p30	p30	p30	p31												
5.0pF	p30	p30	p30	p30	p31												
6.0pF	p30	p30	p30	p30	p31												
7.0pF	p30	p30	p30	p30	p31												
8.0pF	p30	p30	p30	p30	p31												
9.0pF	p30	p30	p30	p30	p31												
10pF	p30	p30	p30	p30	p31	p31											
12pF	p30	p30	p30	p30	p31	p31											
15pF	p30	p30	p30	p30	p31	p31											
18pF	p30	p30	p30	p30	p31	p31											
22pF	p30	p30	p30	p30	p31	p31											
27pF	p30	p30	p30	p30	p31	p31											
33pF	p30	p30	p30	p30	p31	p31											
39pF	p30	p30	p30	p30	p31	p31											
47pF	p30	p30	p30	p30	p31	p31											
56pF	p30	p30	p30	p30	p31	p31											
68pF	p30	p30	p30	p30	p31	p31											
82pF	p30	p30	p30	p31	p31	p31											
100pF	p30	p30	p30	p31	p31	p31											
120pF		p30			p31	p31	p31										
150pF		p30	p30		p31	p31	p31										
180pF		p30	p30		p31	p31	p31										
220pF		p30	p30		p31	p31	p31										
270pF			p30		p31	p31	p31										
330pF			p30		p31	p31	p31										
390pF			p30		p31	p31	p31										
470pF			p30		p31	p31	p31										
560pF			p30		p31	p31	p31										
680pF			p30		p31	p31	p31										
820pF			p30		p31	p31	p31										
1000pF			p30		p31	p31	p31										
1200pF							p31	p31	p31								
1500pF							p31	p31	p31								
1800pF								p31		p31	p31						
2200pF								p31		p31	p31						
2700pF								p31			p32						
3300pF								p31			p32						
3900pF								p31				p32					
4700pF								p31	p31				p32				
5600pF								p31	p31					p32			
6800pF								p31	p31						p32		
8200pF								p31	p31							p32	
10000pF								p31	p31								p32
18000pF												p32	p32				
22000pF												p32	p32				
56000pF																p32	
68000pF																p32	
82000pF																p32	
0.10μF														p32	p32	p32	
0.12μF																p32	p32

# Capacitance Table

p00 Each number in the Part Number List refers to the page number printed at the bottom of the page.

## GRT Series High Dielectric Constant Type

p00 ← Part Number List    EIA: X6S X7S X5R X7R X7T

L×W (mm)	0.6×0.3																	1.0×0.5								
	0.33																	0.35			0.39			0.55		
T max. (mm)	0.33																	0.35			0.39			0.55		
Rated Voltage (Vdc)	35	25			16			10			6.3			4	6.3	4	10	6.3	2.5	50	35	25				
Cap. / TC Code	X5R	X7R	X6S	X5R	X7S	X6S	X5R	X7R	X7S	X6S	X5R	X7R	X7S	X6S	X5R	X6S	X5R	X6S	X7T	X6S	X7T	X7R	X6S	X5R	X7R	
100pF				p33																						
150pF		p33	p33	p33																						
220pF				p33																					p33	
330pF				p33																					p33	
470pF		p33	p33	p33																					p33	
680pF				p33																					p33	
1000pF		p33	p33	p33																					p33	
1500pF															p33										p33	
2200pF															p33	p33									p33	
3300pF															p33	p33									p33	
4700pF				p33											p33	p33									p33	
6800pF				p33											p33	p33									p33	
10000pF				p33						p33	p33				p33	p33									p33	p34
15000pF										p33					p33										p33	
22000pF										p33					p33										p33	p34
33000pF										p33					p33										p33	p34
47000pF										p33					p33										p33	p34
68000pF										p33					p33										p33	p34
0.10µF	p33		p33	p33	p33	p33	p33		p33	p33				p33	p33	p33								p33	p34	
0.15µF																										
0.22µF											p33				p33	p33	p33							p33	p33	
0.33µF																										
0.47µF																										
0.68µF																										
1.0µF																										
1.5µF																										
2.2µF																										
3.3µF																										
4.7µF																										
6.8µF																										
10µF																										
15µF																										
22µF																										
33µF																										
47µF																										
100µF																										

Continued on the following page. ↗

# Capacitance Table

p00 Each number in the Part Number List refers to the page number printed at the bottom of the page.

(→ GRT Series High Dielectric Constant Type)

p00 ← Part Number List    EIA: X6S X7S X5R X7R X7T

L×W (mm)	1.0×0.5																													
	0.55												0.6						0.65		0.7									
T max. (mm)	0.55												0.6						0.65		0.7									
Rated Voltage (Vdc)	25			16			10			6.3			4			35	25	16	10	6.3	4	10	6.3	25	16	10	6.3			
Cap. / TC Code	X6S	X5R	X7R	X6S	X5R	X7R	X6S	X5R	X7R	X6S	X5R	X7R	X6S	X5R	X7R	X5R	X6S	X6S	X7S	X5R	X5R	X5R	X6S	X5R	X6S	X5R	X7S	X6S	X7S	
100pF																														
150pF																														
220pF																														
330pF																														
470pF																														
680pF																														
1000pF																														
1500pF																														
2200pF																														
3300pF																														
4700pF																														
6800pF																														
10000pF			p34																											
15000pF																														
22000pF			p34									p34																		
33000pF			p34																											
47000pF			p34																											
68000pF			p34																											
0.10μF			p34																											
0.15μF																														
0.22μF	p34	p34	p34			p34	p34					p34	p34	p34																
0.33μF																														
0.47μF		p34				p34	p34	p34																						
0.68μF																														
1.0μF		p34																												
1.5μF																														
2.2μF																														
3.3μF																														
4.7μF																														
6.8μF																														
10μF																														
15μF																														
22μF																														
33μF																														
47μF																														
100μF																														

Continued on the following page. ↗

# Capacitance Table

p00 Each number in the Part Number List refers to the page number printed at the bottom of the page.

(→ GRT Series High Dielectric Constant Type)

p00 ← Part Number List      EIA: X6S X7S X5R X7R X7T

L×W (mm)	1.6×0.8																												
	0.9								0.95								1.0												
T max. (mm)	0.7								0.7								0.7												
Rated Voltage (Vdc)	2.5	100	50	35	25	16	6.3	4	25	16	10	2.5	50	35	25	16	10	6.3	4	2.5	100	50	35	25	16	6.3	4		
Cap. / TC Code	X6S	X7R	X5R	X6S	X5R	X7R	X7R	X5R	X6S	X5R	X5R	X6S	X5R	X5R	X5R	X5R	X6S	X5R	X6S	X5R	X6S	X7T	X6S	X5R	X7T	X6S	X5R	X6S	
100pF																													
150pF																													
220pF																													
330pF																													
470pF																													
680pF																													
1000pF																													
1500pF																													
2200pF																													
3300pF		p34																											
4700pF																													
6800pF																													
10000pF		p34																											
15000pF																													
22000pF																													
33000pF																													
47000pF																													
68000pF																													
0.10μF																													
0.15μF																													
0.22μF																													
0.33μF																													
0.47μF																													
0.68μF																													
1.0μF																													
1.5μF																													
2.2μF																													
3.3μF																													
4.7μF																													
6.8μF																													
10μF																													
15μF																													
22μF																													
33μF																													
47μF																													
100μF																													

Continued on the following page. ↗

# Capacitance Table

p00 Each number in the Part Number List refers to the page number printed at the bottom of the page.

(→ GRT Series High Dielectric Constant Type)

p00 ← Part Number List      EIA: X6S X7S X5R X7R X7T

L×W (mm)	2.0×1.25																				3.2×1.6						
T max. (mm)	0.95				1.35				1.4								1.45				1.8						
Rated Voltage (Vdc)	16	10	100	50	16	50	35	25	16	10	6.3	50	25	16	10	6.3	4	50									
Cap. / TC Code	X5R	X6S	X7R	X7R	X7R	X5R	X6S	X7R	X5R	X7R	X6S	X7R	X5R	X5R	X7S	X7S	X5R	X7S	X5R	X7T	X6S	X7T	X5R	X6S	X5R	X6S	
100pF																											
150pF																											
220pF																											
330pF																											
470pF																											
680pF																											
1000pF																											
1500pF																											
2200pF																											
3300pF																											
4700pF																											
6800pF																											
10000pF																											
15000pF																											
22000pF																											
33000pF																											
47000pF			p35																								
68000pF																											
0.10μF																											
0.15μF																											
0.22μF																											
0.33μF																											
0.47μF				p35																							
0.68μF					p35																						
1.0μF						p35																					p35
1.5μF																											
2.2μF							p35																				
3.3μF	p34																										
4.7μF		p35					p35	p35																			
6.8μF																											
10μF																											
15μF																											
22μF																											
33μF																											
47μF																											
100μF																											

Continued on the following page. ↗

# Capacitance Table

p00 Each number in the Part Number List refers to the page number printed at the bottom of the page.

(→ GRT Series High Dielectric Constant Type)

p00 ← Part Number List      EIA: X6S X7S X5R X7R X7T

L×W (mm)	3.2×1.6														3.2×2.5														
	1.8				1.8										1.5	2.2			2.7										
T max. (mm)	25		16		50		35		25		16		10		6.3		25	50		6.3		50		16		10		6.3	
Rated Voltage (Vdc)	X6S	X5R	X6S	X5R	X7R	X6S	X5R	X6S	X5R	X6S	X5R	X6S	X5R	X6S	X5R	X6S	X5R	X6S	X5R	X7R	X6S	X6S	X6S	X7R	X7S	X5R			
Cap. / TC Code	X6S	X5R	X6S	X5R	X7R	X6S	X5R	X6S	X5R	X6S	X5R	X6S	X5R	X6S	X5R	X6S	X5R	X6S	X5R	X7R	X6S	X6S	X6S	X7R	X7S	X5R			
100pF																													
150pF																													
220pF																													
330pF																													
470pF																													
680pF																													
1000pF																													
1500pF																													
2200pF																													
3300pF																													
4700pF																													
6800pF																													
10000pF																													
15000pF																													
22000pF																													
33000pF																													
47000pF																													
68000pF																													
0.10μF																													
0.15μF																													
0.22μF																													
0.33μF																													
0.47μF																													
0.68μF																													
1.0μF																													
1.5μF	p35	p35	p35	p35		p35	p35																						
2.2μF					p35	p35																							
3.3μF												p35							p35	p35									
4.7μF																					p35	p35							
6.8μF			p35	p35																									
10μF																													
15μF																													
22μF																													
33μF																													
47μF																													
100μF																													



# Capacitance Table

p00 Each number in the Part Number List refers to the page number printed at the bottom of the page.

## GCM Series Temperature Compensating Type

p00 ← Part Number List      EIA: C0G U2J      Murata Temperature Characteristic: X8G ZLM

L×W (mm)	0.6×0.3		1.0×0.5		1.6×0.8				2.0×1.25								3.2×1.6									
	T max. (mm)		0.55		0.9				0.7		0.95			1.0		1.4		1.45		0.95		1.0				
Rated Voltage (Vdc)	50	25	50		100	80	50	100	80	100	80	50	630	250	80	50	630	250	100	80	1000					
Cap. / TC Code	C0G	C0G	C0G	X8G	C0G	U2J	C0G	C0G	U2J	C0G	C0G	ZLM	C0G	C0G	C0G	C0G	U2J	C0G	C0G	C0G	C0G	U2J	C0G	C0G	C0G	U2J
1.0pF	p37	p37	p37	p37	p38																					
2.0pF	p37	p37	p37	p37	p38																					
3.0pF	p37	p37	p37	p37	p38																					
4.0pF	p37	p37	p37	p37	p38																					
5.0pF	p37	p37	p37	p37	p38																					
6.0pF	p37	p37	p37		p38																					
7.0pF	p37	p37	p37		p38																					
8.0pF	p37	p37	p37		p38																					
9.0pF	p37	p37	p37		p38																					
10pF	p37	p37	p37		p38									p39	p39									p39	p39	
12pF	p37	p37	p37	p37	p38																					
15pF	p37	p37	p37	p37	p38									p39	p39									p39	p39	
18pF	p37	p37	p37	p37	p38																					
22pF	p37	p37	p37	p37	p38									p39	p39									p39	p39	
27pF	p37	p37	p37	p37	p38																					
33pF	p37	p37	p37	p37	p38									p39	p39									p39	p39	
39pF	p37	p37	p37	p37	p38																					
47pF	p37	p37	p37	p37	p38									p39	p39									p39	p39	
56pF	p37	p37	p37	p37	p38																					
68pF	p37	p37	p37	p37	p38									p39	p39									p39	p39	
82pF	p37	p37	p37	p37	p38																					
100pF	p37	p37	p37	p37	p38									p39	p39	p39								p39	p39	
120pF			p37	p37	p38																					
150pF			p37	p37	p38									p39	p39	p39								p39	p39	
180pF			p37	p37	p38																					
220pF			p37	p37	p38									p39	p39	p39								p39	p39	
270pF			p37	p37	p38																					
330pF			p37	p37	p38									p39	p39	p39								p39	p39	
390pF			p37	p38	p38																					
470pF			p37	p38	p38									p39	p39	p39								p39		
560pF			p37	p38	p38																					
680pF			p37	p38	p38									p39	p39			p39								
820pF			p37	p38	p38																					
1000pF			p37	p38	p38	p38				p38					p39	p39			p39							
1100pF																										
1200pF					p38	p38				p38	p38															
1300pF																										
1500pF					p38	p38				p38	p38															
1800pF						p38	p38	p38	p38	p38																
2200pF						p38	p38	p38	p38	p38																
2700pF						p38	p38	p38	p38	p38																
3300pF						p38		p38	p38	p38													p39	p39		
3900pF						p38	p38	p38																	p39	
4700pF						p38		p38	p38		p38												p39	p39	p39	
5600pF						p38		p38	p38																p39	
6800pF						p38		p38	p38				p39												p39	
8200pF						p38		p38	p38				p39												p39	
10000pF						p38		p38	p38				p39												p39	
12000pF													p39	p39												
15000pF													p39	p39												
18000pF																										
22000pF																										
27000pF																										
33000pF																										
39000pF																										
47000pF																										
68000pF																										
82000pF																										
0.10μF																										

Continued on the following page. ↗

# Capacitance Table

p00 Each number in the Part Number List refers to the page number printed at the bottom of the page.

(→ GCM Series Temperature Compensating Type)

p00 ← Part Number List EIA: COG U2J Murata Temperature Characteristic: X8G ZLM

L×W (mm)	3.2×1.6										3.2×2.5				4.5×3.2		5.7×5.0	
	1.0		1.25		1.8		1.8		1.8		1.0	1.5	2.0	1.5	2.0	1.5	2.0	
T max. (mm)	1.0		1.25		1.8		1.8		1.8		1.0	1.5	2.0	1.5	2.0	1.5	2.0	
Rated Voltage (Vdc)	630		1000		630		250		1000		630		250		100		100	
Cap. / TC Code	COG	U2J	COG	U2J	COG	U2J	U2J	COG	U2J	COG	U2J	COG	U2J	COG	U2J	U2J	COG	U2J
1.0pF																		
2.0pF																		
3.0pF																		
4.0pF																		
5.0pF																		
6.0pF																		
7.0pF																		
8.0pF																		
9.0pF																		
10pF	p39	p39																
12pF																		
15pF	p39	p39																
18pF																		
22pF	p39	p39																
27pF																		
33pF	p39	p40																
39pF																		
47pF	p39	p40																
56pF																		
68pF	p39	p40																
82pF																		
100pF	p39	p40																
120pF																		
150pF	p39	p40																
180pF																		
220pF	p39	p40																
270pF																		
330pF	p39	p40																
390pF																		
470pF	p39	p40	p40															
560pF																		
680pF	p39	p40	p40	p40														
820pF																		
1000pF	p39	p40					p40	p40										
1100pF																		
1200pF																		
1300pF																		
1500pF	p39	p40									p40	p40						
1800pF																		
2200pF	p40			p40							p40		p40					
2700pF																		
3300pF					p40				p40					p40				
3900pF																		
4700pF									p40	p40						p40		
5600pF																		
6800pF						p40						p40					p40	
8200pF																		
10000pF							p40							p40				p40
12000pF																		
15000pF									p40								p40	
18000pF																		
22000pF									p40							p40		
27000pF																		
33000pF																		p40
39000pF																		
47000pF																		p40
68000pF																		
82000pF																		
0.10μF																		

# Capacitance Table

p00 Each number in the Part Number List refers to the page number printed at the bottom of the page.

## GCM Series High Dielectric Constant Type

p00 ← Part Number List    EIA: X7S X7T X7R X8R    Murata Temperature Characteristic: X8L X8M

L×W (mm)	0.6×0.3			1.0×0.5						1.6×0.8						2.0×1.25							
T max. (mm)	0.33			0.55			0.6	0.7	0.9			1.0			0.95			1.4					
Rated Voltage (Vdc)	25	16	10	100	50	25	16	10	10	100	50	25	16	6.3	6.3	4	100	50	25	16	100	50	35
Cap. / TC Code	X7R	X7R	X7R	X7R	X8L	X7R	X8L	X7R	X7S	X7R	X7R	X7R	X7R	X7R	X7T	X7R	X7R	X7R	X7R	X7R	X7R	X8L	X7R
100pF	p41																						
150pF	p41																						
220pF	p41			p41	p41																		
330pF	p41	p41		p41	p41																		
470pF	p41			p41	p41																		
680pF	p41	p41		p41	p41																		
1000pF	p41			p41	p41																		
1500pF	p41			p41	p41																		
2200pF	p41	p41		p41	p41																		
3300pF	p41	p41		p41	p41																		
4700pF			p41	p41	p41																		
6800pF			p41		p41							p41											
10000pF			p41		p41			p41				p41											
15000pF					p41			p41				p41											
22000pF					p41			p41				p41											
33000pF					p41	p41		p41	p41								p41						
47000pF					p41	p41		p41	p41													p41	
68000pF					p41	p41		p41	p41													p41	
0.10μF					p41	p41	p41															p41	
0.15μF								p41															p41
0.22μF								p41				p41	p41										p41
0.33μF														p41					p41				
0.47μF									p41					p41	p41				p41				p41
0.68μF										p41										p41			p41
1.0μF										p41										p41			p41
1.5μF																							p41
2.2μF																							
4.7μF																							p41
10μF																							
22μF																							
47μF																							

Continued on the following page. ↗

# Capacitance Table

p00 Each number in the Part Number List refers to the page number printed at the bottom of the page.

(→ GCM Series High Dielectric Constant Type)

p00 ← Part Number List    EIA: X7S X7T X7R X8R    Murata Temperature Characteristic: X8L X8M

L×W (mm)	2.0×1.25												3.2×1.6											
	1.4						1.45						1.25		1.8									
T max. (mm)	1.4						1.45						1.25		1.8									
Rated Voltage (Vdc)	35	25	16	10	6.3	100	35	25	16	100	25	100	50	25	16	10	6.3							
Cap. / TC Code	X7S	X8L	X7R	X7R	X7S	X7R	X7S	X8L	X7S	X8L	X7S	X8M	X7S	X7R	X8L	X8L	X7S	X8L	X7R	X7S	X8R	X7R	X7R	X7R
100pF																								
150pF																								
220pF																								
330pF																								
470pF																								
680pF																								
1000pF																								
1500pF																								
2200pF																								
3300pF																								
4700pF																								
6800pF																								
10000pF																								
15000pF																								
22000pF																								
33000pF																								
47000pF																								
68000pF																								
0.10μF																								
0.15μF																								
0.22μF																								
0.33μF																								
0.47μF																								
0.68μF																								
1.0μF																								
1.5μF																								
2.2μF																								
4.7μF																								
10μF																								
22μF																								
47μF																								

Continued on the following page. ↗

# Capacitance Table

p00 Each number in the Part Number List refers to the page number printed at the bottom of the page.

## (→ GCM Series High Dielectric Constant Type)

p00 ← Part Number List    EIA: X7S X7T X7R X8R    Murata Temperature Characteristic: X8L X8M

L×W (mm)	3.2×2.5													
	3.2×1.6		2.2		2.7								2.85	
T max. (mm)	1.9													
Rated Voltage (Vdc)	25		100		50		35	25	16	10	6.3	25		
Cap. / TC Code	X7S	X8L	X7S	X8L	X7R	X7S	X7S	X7R	X7R	X7R	X7S	X7R	X8L	X7S
100pF														
150pF														
220pF														
330pF														
470pF														
680pF														
1000pF														
1500pF														
2200pF														
3300pF														
4700pF														
6800pF														
10000pF														
15000pF														
22000pF														
33000pF														
47000pF														
68000pF														
0.10μF														
0.15μF														
0.22μF														
0.33μF														
0.47μF														
0.68μF														
1.0μF														
1.5μF														
2.2μF														
4.7μF			p42	p42		p42								
10μF	p42			p42		p42	p42	p42						
22μF									p42	p42			p42	p42
47μF											p42	p42		

## GC3 Series High Dielectric Constant Type

p00 ← Part Number List    EIA: X7T

L×W (mm)	2.0×1.25		3.2×1.6						3.2×2.5				4.5×3.2				5.7×5.0			
	1.0	1.45	1.0	1.25	1.8	1.5	2.0	1.5	2.0	1.5	2.0	2.0	2.7							
Rated Voltage (Vdc)	250	250	450	250	630	450	250	630	450	250	630	250	630	450	250	630	450	250	630	250
Cap. / TC Code	X7T	X7T	X7T	X7T	X7T	X7T	X7T	X7T	X7T	X7T	X7T	X7T	X7T	X7T	X7T	X7T	X7T	X7T	X7T	X7T
10000pF	p44		p44		p44															
15000pF	p44		p44				p44													
22000pF		p44			p44					p44										
33000pF				p44	p44						p44									
47000pF						p44		p44				p44								
68000pF									p44				p44							
0.10μF										p44				p44						
0.15μF											p44				p44					
0.22μF												p44				p44				
0.33μF													p44				p44			
0.47μF														p44				p44		
0.68μF															p44				p44	
1.0μF																				p44

# Capacitance Table

p00 Each number in the Part Number List refers to the page number printed at the bottom of the page.

## GCJ Series High Dielectric Constant Type

p00 ← Part Number List

EIA: X7S X7R X8R

Murata Temperature Characteristic: X8L X8M

L×W (mm)	1.6×0.8															2.0×1.25														
	0.9															1.0			0.95		1.0	1.45								
	100			50		35		25			16			10			6.3			6.3			100	50	25	16	250	250	100	50
Rated Voltage (Vdc)	X8L	X8R	X7R	X8L	X8R	X7R	X8L	X8L	X8R	X7R	X8L	X7R	X7R	X7R	X8L	X8M	X7S	X7R	X7R	X7R	X7R	X7R	X7R	X7R	X7R	X7R	X7R	X7R	X8L	X7R
Cap. / TC Code	X8L	X8R	X7R	X8L	X8R	X7R	X8L	X8L	X8R	X7R	X8L	X7R	X7R	X7R	X8L	X8M	X7S	X7R	X7R	X7R	X7R	X7R	X7R	X7R	X7R	X7R	X7R	X7R	X7R	
1000pF		p46	p46			p46				p46																p47				
1200pF		p46	p46			p46				p46																p47				
1500pF		p46	p46			p46				p46																p47				
1800pF		p46	p46			p46				p46																p47				
2200pF		p46	p46			p46				p46																p47				
2700pF		p46	p46			p46				p46																p47				
3300pF		p46	p46			p46				p46																p47				
3900pF		p46	p46			p46				p46																p47				
4700pF		p46	p46		p46	p46				p46																p47				
5600pF		p46	p46			p46				p46																p47				
6800pF		p46	p46			p46				p46																p47				
8200pF		p46	p46			p46				p46																				
10000pF		p46	p46		p46	p46				p46																	p47			
12000pF		p46	p46			p46				p46																				
15000pF		p46	p46			p46				p47																	p47			
18000pF		p46	p46			p46				p47																				
22000pF		p46	p46			p46				p47																	p47			
27000pF		p46								p47															p47					
33000pF		p46				p46	p46	p46		p47												p47								
39000pF		p46				p46	p46	p46		p47												p47								
47000pF		p46				p46				p47																		p47		
56000pF		p46				p46	p46	p46		p47																		p47		
68000pF		p46				p46	p46	p46		p47																		p47		
82000pF						p46		p46		p47																	p47	p47		
0.10µF	p46		p46		p46	p46				p47																	p47	p47		
0.12µF					p46					p47																				
0.15µF				p46	p46	p46				p47																				
0.18µF					p46					p47																				
0.22µF				p46	p46	p46				p47	p47	p47	p47																p47	
0.27µF																														
0.33µF									p46														p47	p47						
0.39µF									p46																					
0.47µF									p46																			p47	p47	
0.56µF																														
0.68µF																										p47				
0.82µF																										p47				
1.0µF																										p47			p47	
1.5µF																														
2.2µF																														
3.3µF																														
4.7µF																														
6.8µF																														
10µF																														
22µF																														
47µF																														

Continued on the following page. ↗

# Capacitance Table

p00 Each number in the Part Number List refers to the page number printed at the bottom of the page.

## (→ GCJ Series High Dielectric Constant Type)

p00 ← Part Number List     EIA: X7S X7R X8R     Murata Temperature Characteristic: X8L X8M

L×W (mm)	2.0×1.25										3.2×1.6														
	1.45					1.5	1.25			1.35		1.8			1.9										
T max. (mm)	1.45					1.5	1.25			1.35		1.8			1.9										
Rated Voltage (Vdc)	35	25	16	10	100	1000	630	250	100	50	25	1000	630	250	100	50	35	25	16	10					
Cap. / TC Code	X8L	X8L	X7R	X8L	X7R	X7S	X7R	X7R	X7R	X7R	X7R	X7R	X7R	X7R	X8L	X7R	X7S	X7R	X7S	X8L	X7R	X8L	X7R	X8L	
1000pF							p48	p48																	
1200pF																									
1500pF							p48	p48																	
1800pF																									
2200pF							p48	p48																	
2700pF																									
3300pF							p48	p48																	
3900pF																									
4700pF							p48	p48																	
5600pF																									
6800pF								p48					p48												
8200pF																									
10000pF							p48						p48												
12000pF																									
15000pF								p48					p48												
18000pF																									
22000pF								p48					p48												
27000pF																									
33000pF																									
39000pF																									
47000pF																									
56000pF																									
68000pF								p48																	
82000pF																									
0.10μF																									
0.12μF	p47	p47																							
0.15μF	p47	p47								p48															
0.18μF	p47	p47								p48															
0.22μF	p47	p47								p48															
0.27μF		p47	p47				p47																		
0.33μF	p47	p47					p47																		
0.39μF		p47	p47				p47																		
0.47μF	p47	p47					p47																		
0.56μF			p47	p47	p47						p48													p48	
0.68μF		p47	p47	p47							p48													p48	
0.82μF		p47	p47	p47							p48													p48	
1.0μF		p47	p47	p47	p47			p48				p48				p48	p48							p48	
1.5μF			p47																				p48		
2.2μF			p47				p48	p48					p48					p48	p48						
3.3μF													p48												
4.7μF							p48																	p48	p48
6.8μF																									
10μF							p48																		p48
22μF																									
47μF																									p48

Continued on the following page. ↗

# Capacitance Table

p00 Each number in the Part Number List refers to the page number printed at the bottom of the page.

(→ GCJ Series High Dielectric Constant Type)

p00 ← Part Number List

EIA: X7S X7R X8R

Murata Temperature Characteristic: X8L X8M

L×W (mm)	3.2×1.6				3.2×2.5										4.5×3.2					5.7×5.0					
T max. (mm)	1.9	2.0		1.5	2.0		2.3		2.8				2.85		1.5		2.0			2.0					
Rated Voltage (Vdc)	10	6.3	25		630	250	1000	630	250	100		50	25	16	6.3	25	630	250	1000	630	250	1000	630	250	
Cap. / TC Code	X7R	X7R	X8L	X7S	X7R	X7R	X7R	X7R	X7R	X8L	X7R	X7S	X7R	X7S	X8L	X8R	X7R	X7R	X8L	X7S	X7R	X7R	X7R	X7R	X7R
1000pF																									
1200pF																									
1500pF																									
1800pF																									
2200pF																									
2700pF																									
3300pF																									
3900pF																									
4700pF																									
5600pF																									
6800pF																									
8200pF																									
10000pF																									
12000pF																									
15000pF																									
18000pF																									
22000pF																									
27000pF																									
33000pF																									
39000pF																									
47000pF																									
56000pF																									
68000pF																									
82000pF																									
0.10µF																									
0.12µF																									
0.15µF																									
0.18µF																									
0.22µF																									
0.27µF																									
0.33µF																									
0.39µF																									
0.47µF																									
0.56µF																									
0.68µF																									
0.82µF																									
1.0µF																									
1.5µF																									
2.2µF																									
3.3µF																									
4.7µF																									
6.8µF	p48																								
10µF	p48																								
22µF	p48	p48																							
47µF																									



# Capacitance Table

p00 Each number in the Part Number List refers to the page number printed at the bottom of the page.

## GCQ Series Temperature Compensating Type

p00 ← Part Number List

EIA: C0G

L×W (mm)	1.0× 0.5
T max. (mm)	0.55
Rated Voltage (Vdc)	50
Cap. / TC Code	C0G
0.10pF	p52
0.20pF	p52
0.30pF	p52
0.40pF	p52
0.50pF	p52
0.60pF	p52
0.70pF	p52
0.80pF	p52
0.90pF	p52
1.0pF	p52
1.1pF	p52
1.2pF	p52
1.3pF	p52
1.4pF	p52
1.5pF	p52
1.6pF	p52
1.7pF	p52
1.8pF	p52
1.9pF	p52
2.0pF	p52
2.1pF	p52
2.2pF	p52
2.3pF	p52
2.4pF	p52
2.5pF	p52
2.6pF	p52
2.7pF	p52
2.8pF	p52
2.9pF	p52
3.0pF	p52
3.1pF	p52
3.2pF	p52
3.3pF	p52
3.4pF	p52
3.5pF	p52
3.6pF	p52
3.7pF	p52
3.8pF	p52
3.9pF	p52
4.0pF	p53
4.1pF	p53
4.2pF	p53
4.3pF	p53
4.4pF	p53
4.5pF	p53
4.6pF	p53
4.7pF	p53
4.8pF	p53
4.9pF	p53
5.0pF	p53
5.1pF	p53
5.2pF	p53
5.3pF	p53
5.4pF	p53
5.5pF	p53

L×W (mm)	1.0× 0.5
T max. (mm)	0.55
Rated Voltage (Vdc)	50
Cap. / TC Code	C0G
5.6pF	p53
5.7pF	p53
5.8pF	p53
5.9pF	p53
6.0pF	p53
6.1pF	p53
6.2pF	p53
6.3pF	p53
6.4pF	p53
6.5pF	p53
6.6pF	p53
6.7pF	p53
6.8pF	p53
6.9pF	p53
7.0pF	p54
7.1pF	p54
7.2pF	p54
7.3pF	p54
7.4pF	p54
7.5pF	p54
7.6pF	p54
7.7pF	p54
7.8pF	p54
7.9pF	p54
8.0pF	p54
8.1pF	p54
8.2pF	p54
8.3pF	p54
8.4pF	p54
8.5pF	p54
8.6pF	p54
8.7pF	p54
8.8pF	p54
8.9pF	p54
9.0pF	p54
9.1pF	p54
9.2pF	p54
9.3pF	p54
9.4pF	p54
9.5pF	p54
9.6pF	p54
9.7pF	p55
9.8pF	p55
9.9pF	p55
10pF	p55
11pF	p55
12pF	p55
13pF	p55
15pF	p55
16pF	p55
18pF	p55
20pF	p55
22pF	p55
24pF	p55
27pF	p55

L×W (mm)	1.0× 0.5
T max. (mm)	0.55
Rated Voltage (Vdc)	50
Cap. / TC Code	C0G
30pF	p55
33pF	p55
36pF	p55
39pF	p55
43pF	p55
47pF	p55

## GCD Series High Dielectric Constant Type

p00 ← Part Number List

EIA: X7S X7R

L×W (mm)	1.6×0.8			2.0×1.25		
	T max. (mm)					
	0.9			1.4		
Rated Voltage (Vdc)	100	50	25	100	50	16
Cap. / TC Code	X7R	X7R	X7R	X7R	X7R	X7S
1000pF	p57	p57				
1200pF	p57	p57				
1500pF	p57	p57				
1800pF	p57	p57				
2200pF	p57	p57				
2700pF	p57	p57				
3300pF	p57	p57				
3900pF	p57	p57				
4700pF	p57	p57				
5600pF	p57	p57				
6800pF	p57	p57				
8200pF	p57	p57				
10000pF	p57	p57				
12000pF	p57	p57				
15000pF	p57	p57				
18000pF	p57	p57				
22000pF	p57	p57				
27000pF			p57	p57	p57	
33000pF			p57	p57	p57	
39000pF			p57	p57	p57	
47000pF			p57	p57	p57	
56000pF				p57	p57	
68000pF				p57	p57	
82000pF				p57	p57	
0.10μF				p57	p57	
0.47μF						p57

# Capacitance Table

p00 ← Part Number List      EIA: X7R      Each number in the Part Number List refers to the page number printed at the bottom of the page.

## GCE Series High Dielectric Constant Type

p00 ← Part Number List      EIA: X7R

L×W (mm)	1.6×0.8			2.0×1.25	
T max. (mm)	0.9			1.45	
Rated Voltage (Vdc)	100	50	25	100	50
Cap. / TC Code	X7R	X7R	X7R	X7R	X7R
1000pF	p59	p59			
1200pF	p59	p59			
1500pF	p59	p59			
1800pF	p59	p59			
2200pF	p59	p59			
2700pF	p59	p59			
3300pF	p59	p59			
3900pF	p59	p59			
4700pF	p59	p59			
5600pF	p59	p59			
6800pF	p59	p59			
8200pF	p59	p59			
10000pF	p59	p59			
12000pF	p59	p59			
15000pF	p59	p59			
18000pF	p59	p59			
22000pF	p59	p59			
27000pF			p59	p59	p59
33000pF			p59	p59	p59
39000pF			p59	p59	p59
47000pF			p59	p59	p59
56000pF				p59	p59
68000pF				p59	p59
82000pF				p59	p59
0.10μF				p59	p59

## NFM Series

p00 ← Part Number List

L×W (mm)	1.6×0.8		2.0×1.25		3.2×1.6		
T max. (mm)	0.7		0.95		1.5		
Rated Voltage (Vdc)	16	6.3	50	16	10	100	50
Cap. / TC Code	-	-	-	-	-	-	-
220pF			p62				
470pF			p62				
1000pF			p62				
2200pF			p62				
10000pF						p62	p62
15000pF							p62
22000pF			p62				p62
0.10μF					p62		p62
0.22μF					p62		
0.47μF					p62		
1.0μF	p62	p62		p62			

## KCM Series Temperature Compensating Type

p00 ← Part Number List      EIA: C0G

L×W (mm)	6.1×5.1			
T max. (mm)	3.1	3.9	5.1	6.6
Rated Voltage (Vdc)	630	630	630	630
Cap. / TC Code	C0G	C0G	C0G	C0G
0.015μF	p65			
0.018μF	p65			
0.022μF		p65		
0.027μF		p65		
0.030μF			p65	
0.036μF			p65	
0.044μF				p65
0.054μF				p65

## KCM Series High Dielectric Constant Type

p00 ← Part Number List      EIA: X7S X7R

L×W (mm)	6.1×5.3																	
T max. (mm)	3.0				3.9				5.0		6.7							
Rated Voltage (Vdc)	100	63	50	35	25	100	63	50	35	25	50	35	100	63	50	35	25	
Cap. / TC Code	X7R	X7R	X7R	X7R	X7R	X7R	X7R	X7R	X7R	X7S	X7R	X7R	X7R	X7R	X7R	X7R	X7R	X7S
4.7μF	p66	p66	p66															
6.8μF						p66												
10μF			p66	p66		p66	p66											
15μF				p66	p66								p66					
17μF								p66	p66									
22μF									p66	p66	p66		p66	p66				
33μF										p66					p66			
47μF											p66					p66	p66	
68μF																	p66	
100μF																		p66

# Capacitance Table

p00 Each number in the Part Number List refers to the page number printed at the bottom of the page.

## KC3 Series High Dielectric Constant Type

p00 ← Part Number List EIA: X7T

L×W (mm)	6.1×5.3											
	3.0			3.9			5.0			6.7		
T max. (mm)	630	450	250	630	450	250	630	450	250	630	450	250
Rated Voltage (Vdc)	X7T	X7T	X7T	X7T	X7T	X7T	X7T	X7T	X7T	X7T	X7T	X7T
Cap. / TC Code	X7T	X7T	X7T	X7T	X7T	X7T	X7T	X7T	X7T	X7T	X7T	X7T
0.10μF	p69											
0.15μF	p69											
0.22μF		p69		p69								
0.27μF				p69								
0.33μF	p69	p69										
0.47μF	p69	p69	p69								p69	
0.56μF				p69	p69						p69	
0.68μF		p69	p69				p69	p69				
1.0μF					p69	p69	p69	p69				
1.2μF										p69	p69	
1.5μF								p69	p69			
2.2μF											p69	p69

## KCA Series Temperature Compensating Type

p00 ← Part Number List EIA: U2J

L×W (mm)	6.1×5.3			
	3.0	3.9	5.0	6.7
T max. (mm)	250	250	250	250
Rated Voltage (Vac (r.m.s.))	U2J	U2J	U2J	U2J
Cap. / TC Code	U2J	U2J	U2J	U2J
100pF	p72			
150pF	p72			
220pF	p72			
330pF	p72			
470pF	p72			
680pF	p72			
1000pF	p72			
1500pF	p72			
2200pF	p72			
3300pF	p72			
4700pF		p72		
6800pF			p72	
10000pF				p72

## GCG Series Temperature Compensating Type

p00 ← Part Number List EIA: U2J Murata Temperature Characteristic: X8G

L×W (mm)	1.0×0.5	1.6×0.8		2.0×1.25	
	0.55	0.9		0.7	0.95
T max. (mm)	50	100	50	50	50
Rated Voltage (Vdc)	X8G	X8G	U2J	X8G	X8G
Cap. / TC Code	X8G	X8G	U2J	X8G	X8G
10pF		p74		p74	
12pF		p74		p74	
15pF		p74		p74	
18pF		p74		p74	
22pF		p74		p74	
27pF		p74		p74	
33pF		p74		p74	
39pF		p74		p74	
47pF		p74		p74	
56pF		p74		p74	
68pF		p74		p74	
82pF		p74		p74	
100pF		p74		p74	
120pF	p74	p74		p74	
150pF	p74	p74		p74	
180pF	p74	p74		p74	
220pF	p74	p74		p74	
270pF	p74	p74		p74	
330pF	p74	p74		p74	
390pF	p74	p74		p74	
470pF	p74	p74		p74	
560pF		p74		p74	
680pF		p74		p74	
820pF		p74		p74	
1000pF		p74	p74	p74	p74
1200pF			p74	p74	p74
1500pF			p74	p74	p74
1800pF			p74	p74	p74
2200pF			p74	p74	p74
2700pF			p74		p74
3300pF			p74		p74
3900pF			p74		p74
4700pF			p74		p74
5600pF			p74		p74
6800pF			p74		p74
8200pF			p74		p74
10000pF			p74		p74

# Capacitance Table

p00 Each number in the Part Number List refers to the page number printed at the bottom of the page.

## GCG Series High Dielectric Constant Type

p00 ← Part Number List    EIA: X7S X7R X8R    Murata Temperature Characteristic: X8L

L×W (mm)	1.0×0.5						1.6×0.8						2.0×1.25																
T max. (mm)	0.55						0.9						1.45																
Rated Voltage (Vdc)	50		25		16		100		50		25		16		10		6.3		50		35		25		16		10		
Cap. / TC Code	X8L	X7R	X8L	X7R	X8L	X7R	X8R	X8L	X8R	X7R	X8R	X7R	X8L	X7R	X7R	X7R	X8L	X7R	X8L	X7R	X8L	X8R	X7R	X8L	X7R	X7R	X7R	X7R	
220pF	p75	p75																											
270pF		p75																											
330pF	p75	p75																											
390pF		p75																											
470pF	p75	p75																											
560pF		p75																											
680pF	p75	p75																											
820pF		p75																											
1000pF	p75	p75						p75																					
1200pF		p75						p75	p75																				
1500pF	p75	p75						p75	p75																				
1800pF		p75						p75																					
2200pF	p75	p75						p75	p75																				
2700pF		p75						p75	p75																				
3300pF	p75	p75						p75	p75																				
3900pF		p75						p75	p75																				
4700pF	p75	p75						p75	p75																				
5600pF			p75	p75				p75	p75																				
6800pF			p75	p75				p75	p75																				
8200pF			p75	p75				p75	p75																				
10000pF			p75	p75				p75	p75																				
12000pF								p75																					
15000pF					p75	p75	p75		p75																				
18000pF					p75	p75	p75																						
22000pF					p75	p75	p75		p75																				
27000pF					p75	p75	p75																						
33000pF					p75	p75	p75		p75																				
39000pF					p75	p75	p75																						
47000pF					p75	p75	p75		p75																				
56000pF						p75	p75																						
68000pF						p75	p75																						
82000pF						p75																							
0.10μF						p75	p75		p75																				
0.12μF									p75																				
0.15μF								p75	p75	p75											p76								
0.18μF									p75												p76								
0.22μF								p75	p75	p75											p76								
0.27μF																													
0.33μF											p75										p76						p76	p76	
0.39μF											p75																p76	p76	
0.47μF											p75																p76	p76	
0.56μF																											p76	p76	
0.68μF																					p76	p76				p76	p76	p76	
0.82μF																										p76	p76	p76	
1.0μF																					p76	p76				p76	p76		
1.2μF																													
1.5μF																													
2.2μF																													
3.3μF																													
3.9μF																													
4.7μF																													
6.8μF																													
10μF																													
22μF																													
47μF																													

Continued on the following page. ↗

# Capacitance Table

p00 Each number in the Part Number List refers to the page number printed at the bottom of the page.

(→ GCG Series High Dielectric Constant Type)

p00 ← Part Number List    EIA: X7S X7R X8R    Murata Temperature Characteristic: X8L

L×W (mm)	2.0×1.25			3.2×1.6						3.2×2.5								
T max. (mm)	1.45			1.35		1.9			2.8									
Rated Voltage (Vdc)	6.3		50	25	16	25	16	6.3	50	35	25			16	6.3			
Cap. / TC Code	X8L	X7R	X8R	X7R	X8L	X7R	X8L	X8R	X7R	X8L	X7S	X8L	X7S	X8L	X7R	X7S	X8R	X7R
220pF																		
270pF																		
330pF																		
390pF																		
470pF																		
560pF																		
680pF																		
820pF																		
1000pF																		
1200pF																		
1500pF																		
1800pF																		
2200pF																		
2700pF																		
3300pF																		
3900pF																		
4700pF																		
5600pF																		
6800pF																		
8200pF																		
10000pF																		
12000pF																		
15000pF																		
18000pF																		
22000pF																		
27000pF																		
33000pF																		
39000pF																		
47000pF																		
56000pF																		
68000pF																		
82000pF																		
0.10μF																		
0.12μF																		
0.15μF																		
0.18μF																		
0.22μF			p76															
0.27μF																		
0.33μF			p76															
0.39μF																		
0.47μF																		
0.56μF																		
0.68μF								p76										
0.82μF									p76									
1.0μF					p76													
1.2μF				p76														
1.5μF				p76	p76													
2.2μF				p76														
3.3μF					p76	p76												
3.9μF						p76												
4.7μF						p76	p76											
6.8μF																		p76
10μF	p76	p76								p76	p76	p76	p76		p76			p76
22μF									p76				p76			p76		
47μF																		p76

# Search Capacitors

Specifications and Test Methods, Package, Chart of Characteristic Data, please refer to the search web page.  
<https://www.murata.com/en-global/products/capacitor>

**GRT Series Temperature Compensating**

1.0x0.5mm

T max.	Rated Voltage	TC Code	Cap.	Tol.	Part Number
0.55mm	100Vdc	COG	1.0pF	±0.25pF	GRT1555A1R0CA02#
			2.0pF	±0.25pF	GRT1555A2R0CA02#
			3.0pF	±0.25pF	GRT1555A3R0CA02#
			4.0pF	±0.25pF	GRT1555A4R0CA02#
			5.0pF	±0.25pF	GRT1555C2A5R0CA02#

Links are provided to the product detail pages on the web, and are shown below in the product number table from the PDF version of the catalog which is available on the web.

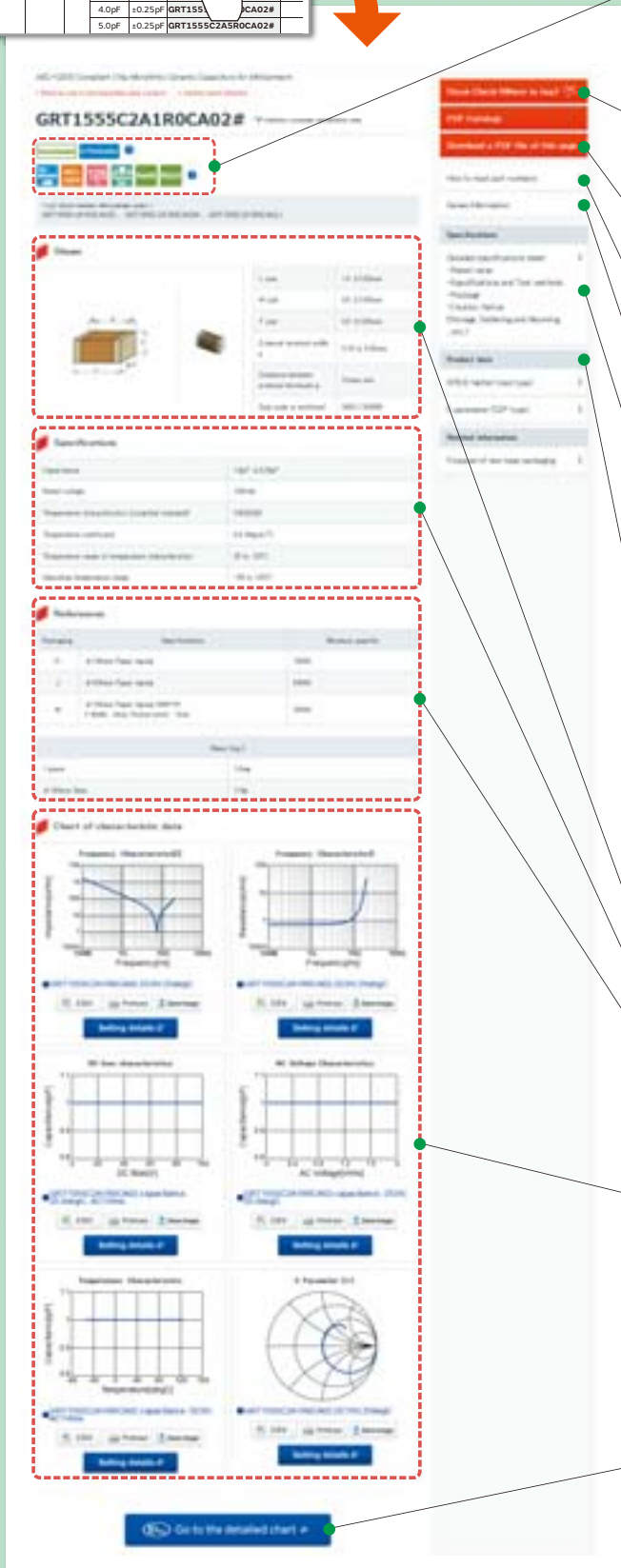

## Status and Features Icons

The status and features of products can be checked at once. When ? is clicked, a description of each icon will be displayed

## Stock Check (Where to buy)

Reference inventory information from agents and web-based companies.

## Data Sheet

The product details page can be output in PDF.

## How to read part numbers

Describes the meaning of the part number

## Series Information

This links to the introduction page of each series.

## Detailed Specifications Sheet

- Rated value
- Specifications and Test Methods
- Package
- Caution, Notice (Storage, Soldering and Mounting, ....etc.)

## Characteristics Data

The following characteristics data of the main products can be acquired.

- SPICE Netlist (mod type)
- S parameter (S2P type)
- Reliability Test Data \*Typical data

- Shape (Dimensions)
- Rated Values

- Specification by Packaging Code/ Minimum Order Quantity
- Weight (1 pc/ø180mm reel)

## Chart of Characteristic Data

The main products published characteristic data.

- Frequency characteristics (ESR, Impedance)
- DC bias characteristics
- AC voltage characteristics
- Capacitance - temperature characteristics
- Calorific property by ripple current

## Design Tools SimSurfing

The SimSurfing design tools are useful for displaying the graph, downloading CSV data and overwriting the product number graph.

AEC-Q200 Compliant Chip Multilayer Ceramic Capacitors for Infotainment

**GRT Series**



Capacitor meet AEC-Q200 (Grade2 or Grade3).

Features

① This product has cleared test conditions meet AEC-Q200.

This series is designed for use in Car Multimedia, Car Interior, Car Comfort application and General Electronic equipment. It is not appropriate for use in applications critical to passenger safety and car driving function (e.g. ABS, AIRBAG, etc.). Please use the GCM series is in critical applications.

	General Purpose GRM Series Maximum operating temperature: <b>125°C</b>	AEC-Q200 metted GRT Series Maximum operating temperature: <b>125°C</b>
Items	Test Method	Test Method
Temperature Cycle	Temperature Cycle: <b>5 cycles</b>	Temperature Cycle: <b>1,000 cycles</b>
Humidity Loading	Test temperature: <b>40±2°C</b> Test humidity: <b>90 to 95%RH</b> Test time: 500 hours	Test temperature: <b>85±2°C</b> Test humidity: <b>80 to 85%RH</b> Test time: 1,000 hours

② Meet AEC-Q200 (Grade2 or Grade3).

105°C product: Grade2.  
 85°C product: Grade3.

③ Sn plating is applied to the external electrodes; excellent solderability.

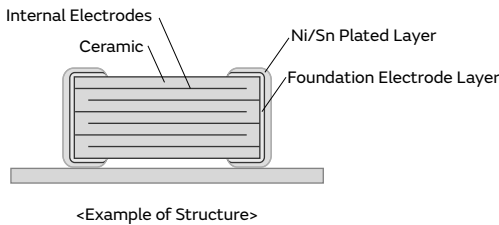

Specifications

Size	0.6×0.3mm to 3.2×2.5mm
Rated Voltage	2.5Vdc to 100Vdc
Capacitance	0.50pF to 100μF
Main Applications	Such as Information and Comfort equipment, car navigation, communication module and entertainment system

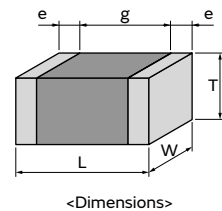

GRT Series  
 GCM Series  
 GC3 Series  
 GCJ Series  
 GCQ Series  
 GCD Series  
 GCE Series  
 NMF Series  
 KCM Series  
 KC3 Series  
 KCA Series  
 GCG Series  
 △Caution /Notice

# GRT Series Temperature Compensating Type Part Number List

## 0.6×0.3mm

T max.	Rated Voltage	TC Code	Cap.	Tol.	Part Number			
0.33mm	100Vdc	COG	1.0pF	±0.25pF	GRT0335C2A1R0CA02#	<b>D1</b>		
			2.0pF	±0.25pF	GRT0335C2A2R0CA02#	<b>D1</b>		
			3.0pF	±0.25pF	GRT0335C2A3R0CA02#	<b>D1</b>		
			4.0pF	±0.25pF	GRT0335C2A4R0CA02#	<b>D1</b>		
			5.0pF	±0.25pF	GRT0335C2A5R0CA02#	<b>D1</b>		
			6.0pF	±0.5pF	GRT0335C2A6R0DA02#	<b>D1</b>		
			7.0pF	±0.5pF	GRT0335C2A7R0DA02#	<b>D1</b>		
			8.0pF	±0.5pF	GRT0335C2A8R0DA02#	<b>D1</b>		
			9.0pF	±0.5pF	GRT0335C2A9R0DA02#	<b>D1</b>		
			10pF	±5%	GRT0335C2A100JA02#	<b>D1</b>		
			12pF	±5%	GRT0335C2A120JA02#	<b>D1</b>		
			15pF	±5%	GRT0335C2A150JA02#	<b>D1</b>		
			18pF	±5%	GRT0335C2A180JA02#	<b>D1</b>		
			22pF	±5%	GRT0335C2A220JA02#	<b>D1</b>		
			27pF	±5%	GRT0335C2A270JA02#	<b>D1</b>		
			33pF	±5%	GRT0335C2A330JA02#	<b>D1</b>		
			39pF	±5%	GRT0335C2A390JA02#	<b>D1</b>		
			47pF	±5%	GRT0335C2A470JA02#	<b>D1</b>		
			56pF	±5%	GRT0335C2A560JA02#	<b>D1</b>		
			68pF	±5%	GRT0335C2A680JA02#	<b>D1</b>		
			82pF	±5%	GRT0335C2A820JA02#	<b>D1</b>		
			100pF	±5%	GRT0335C2A101JA02#	<b>D1</b>		
			50Vdc	COG	1.0pF	±0.25pF	GRT0335C1H1R0CA02#	<b>D1</b>
					2.0pF	±0.25pF	GRT0335C1H2R0CA02#	<b>D1</b>
					3.0pF	±0.25pF	GRT0335C1H3R0CA02#	<b>D1</b>
					4.0pF	±0.25pF	GRT0335C1H4R0CA02#	<b>D1</b>
					5.0pF	±0.25pF	GRT0335C1H5R0CA02#	<b>D1</b>
					6.0pF	±0.5pF	GRT0335C1H6R0DA02#	<b>D1</b>
	7.0pF	±0.5pF			GRT0335C1H7R0DA02#	<b>D1</b>		
	8.0pF	±0.5pF			GRT0335C1H8R0DA02#	<b>D1</b>		
	9.0pF	±0.5pF			GRT0335C1H9R0DA02#	<b>D1</b>		
	10pF	±5%			GRT0335C1H100JA02#	<b>D1</b>		
	12pF	±5%			GRT0335C1H120JA02#	<b>D1</b>		
	15pF	±5%			GRT0335C1H150JA02#	<b>D1</b>		
	18pF	±5%			GRT0335C1H180JA02#	<b>D1</b>		
	22pF	±5%			GRT0335C1H220JA02#	<b>D1</b>		
	27pF	±5%			GRT0335C1H270JA02#	<b>D1</b>		
	33pF	±5%			GRT0335C1H330JA02#	<b>D1</b>		
	39pF	±5%	GRT0335C1H390JA02#	<b>D1</b>				
	47pF	±5%	GRT0335C1H470JA02#	<b>D1</b>				
	56pF	±5%	GRT0335C1H560JA02#	<b>D1</b>				
	68pF	±5%	GRT0335C1H680JA02#	<b>D1</b>				
	82pF	±5%	GRT0335C1H820JA02#	<b>D1</b>				
	100pF	±5%	GRT0335C1H101JA02#	<b>D1</b>				
25Vdc	COG	1.0pF	±0.25pF	GRT0335C1E1R0CA02#	<b>D1</b>			
		2.0pF	±0.25pF	GRT0335C1E2R0CA02#	<b>D1</b>			
		3.0pF	±0.25pF	GRT0335C1E3R0CA02#	<b>D1</b>			
		4.0pF	±0.25pF	GRT0335C1E4R0CA02#	<b>D1</b>			

T max.	Rated Voltage	TC Code	Cap.	Tol.	Part Number	
0.33mm	25Vdc	COG	5.0pF	±0.25pF	GRT0335C1E5R0CA02#	<b>D1</b>
			6.0pF	±0.5pF	GRT0335C1E6R0DA02#	<b>D1</b>
			7.0pF	±0.5pF	GRT0335C1E7R0DA02#	<b>D1</b>
			8.0pF	±0.5pF	GRT0335C1E8R0DA02#	<b>D1</b>
			9.0pF	±0.5pF	GRT0335C1E9R0DA02#	<b>D1</b>
			10pF	±5%	GRT0335C1E100JA02#	<b>D1</b>
			12pF	±5%	GRT0335C1E120JA02#	<b>D1</b>
			15pF	±5%	GRT0335C1E150JA02#	<b>D1</b>
			18pF	±5%	GRT0335C1E180JA02#	<b>D1</b>
			22pF	±5%	GRT0335C1E220JA02#	<b>D1</b>
			27pF	±5%	GRT0335C1E270JA02#	<b>D1</b>
			33pF	±5%	GRT0335C1E330JA02#	<b>D1</b>
			39pF	±5%	GRT0335C1E390JA02#	<b>D1</b>
			47pF	±5%	GRT0335C1E470JA02#	<b>D1</b>
			56pF	±5%	GRT0335C1E560JA02#	<b>D1</b>
			68pF	±5%	GRT0335C1E680JA02#	<b>D1</b>
			82pF	±5%	GRT0335C1E820JA02#	<b>D1</b>
			100pF	±5%	GRT0335C1E101JA02#	<b>D1</b>
			150pF	±5%	GRT0335C1E151JA02#	<b>D1</b>
			180pF	±5%	GRT0335C1E181JA02#	<b>D1</b>
			220pF	±5%	GRT0335C1E221JA02#	<b>D1</b>
			270pF	±5%	GRT0335C1E271JA02#	<b>D1</b>
			330pF	±5%	GRT0335C1E331JA02#	<b>D1</b>
			390pF	±5%	GRT0335C1E391JA02#	<b>D1</b>
			470pF	±5%	GRT0335C1E471JA02#	<b>D1</b>
			560pF	±5%	GRT0335C1E561JA02#	<b>D1</b>
			680pF	±5%	GRT0335C1E681JA02#	<b>D1</b>
			820pF	±5%	GRT0335C1E821JA02#	<b>D1</b>
			1000pF	±5%	GRT0335C1E102JA02#	<b>D1</b>

## 1.0×0.5mm

T max.	Rated Voltage	TC Code	Cap.	Tol.	Part Number	
0.55mm	100Vdc	COG	1.0pF	±0.25pF	GRT1555C2A1R0CA02#	<b>D1</b>
			2.0pF	±0.25pF	GRT1555C2A2R0CA02#	<b>D1</b>
			3.0pF	±0.25pF	GRT1555C2A3R0CA02#	<b>D1</b>
			4.0pF	±0.25pF	GRT1555C2A4R0CA02#	<b>D1</b>
			5.0pF	±0.25pF	GRT1555C2A5R0CA02#	<b>D1</b>
			6.0pF	±0.5pF	GRT1555C2A6R0DA02#	<b>D1</b>
			7.0pF	±0.5pF	GRT1555C2A7R0DA02#	<b>D1</b>
			8.0pF	±0.5pF	GRT1555C2A8R0DA02#	<b>D1</b>
			9.0pF	±0.5pF	GRT1555C2A9R0DA02#	<b>D1</b>
			10pF	±5%	GRT1555C2A100JA02#	<b>D1</b>
			12pF	±5%	GRT1555C2A120JA02#	<b>D1</b>
			15pF	±5%	GRT1555C2A150JA02#	<b>D1</b>
			18pF	±5%	GRT1555C2A180JA02#	<b>D1</b>
			22pF	±5%	GRT1555C2A220JA02#	<b>D1</b>
			27pF	±5%	GRT1555C2A270JA02#	<b>D1</b>
			33pF	±5%	GRT1555C2A330JA02#	<b>D1</b>
			39pF	±5%	GRT1555C2A390JA02#	<b>D1</b>
			47pF	±5%	GRT1555C2A470JA02#	<b>D1</b>
			56pF	±5%	GRT1555C2A560JA02#	<b>D1</b>
			68pF	±5%	GRT1555C2A680JA02#	<b>D1</b>

Part number # indicates the package specification code.

GRT Series  
 GCM Series  
 GC3 Series  
 GCJ Series  
 GCQ Series  
 GCD Series  
 GCE Series  
 NMF Series  
 KCM Series  
 KC3 Series  
 KCA Series  
 GCG Series  
 ⚠Caution/ Notice



# GRT Series Temperature Compensating Type Part Number List

(→ 1.0×0.5mm)

T max.	Rated Voltage	TC Code	Cap.	Tol.	Part Number	
0.55mm	100Vdc	COG	82pF	±5%	GRT1555C2A820JA02#	D1
			100pF	±5%	GRT1555C2A101JA02#	D1
	50Vdc	COG	1.0pF	±0.25pF	GRT1555C1H1R0CA02#	D1
			2.0pF	±0.25pF	GRT1555C1H2R0CA02#	D1
			3.0pF	±0.25pF	GRT1555C1H3R0CA02#	D1
			4.0pF	±0.25pF	GRT1555C1H4R0CA02#	D1
			5.0pF	±0.25pF	GRT1555C1H5R0CA02#	D1
			6.0pF	±0.5pF	GRT1555C1H6R0DA02#	D1
			7.0pF	±0.5pF	GRT1555C1H7R0DA02#	D1
			8.0pF	±0.5pF	GRT1555C1H8R0DA02#	D1
			9.0pF	±0.5pF	GRT1555C1H9R0DA02#	D1
			10pF	±5%	GRT1555C1H100JA02#	D1
			12pF	±5%	GRT1555C1H120JA02#	D1
			15pF	±5%	GRT1555C1H150JA02#	D1
			18pF	±5%	GRT1555C1H180JA02#	D1
			22pF	±5%	GRT1555C1H220JA02#	D1
			27pF	±5%	GRT1555C1H270JA02#	D1
			33pF	±5%	GRT1555C1H330JA02#	D1
			39pF	±5%	GRT1555C1H390JA02#	D1
			47pF	±5%	GRT1555C1H470JA02#	D1
	56pF	±5%	GRT1555C1H560JA02#	D1		
	68pF	±5%	GRT1555C1H680JA02#	D1		
	82pF	±5%	GRT1555C1H820JA02#	D1		
	100pF	±5%	GRT1555C1H101JA02#	D1		
	120pF	±5%	GRT1555C1H121JA02#	D1		
	150pF	±5%	GRT1555C1H151JA02#	D1		
	180pF	±5%	GRT1555C1H181JA02#	D1		
	220pF	±5%	GRT1555C1H221JA02#	D1		
	270pF	±5%	GRT1555C1H271JA02#	D1		
	330pF	±5%	GRT1555C1H331JA02#	D1		
	390pF	±5%	GRT1555C1H391JA02#	D1		
	470pF	±5%	GRT1555C1H471JA02#	D1		
	560pF	±5%	GRT1555C1H561JA02#	D1		
	680pF	±5%	GRT1555C1H681JA02#	D1		
	820pF	±5%	GRT1555C1H821JA02#	D1		
	1000pF	±5%	GRT1555C1H102JA02#	D1		
	25Vdc	COG	10pF	±5%	GRT1555C1E100JA02#	D1
			12pF	±5%	GRT1555C1E120JA02#	D1
			15pF	±5%	GRT1555C1E150JA02#	D1
			18pF	±5%	GRT1555C1E180JA02#	D1
			22pF	±5%	GRT1555C1E220JA02#	D1
			27pF	±5%	GRT1555C1E270JA02#	D1
33pF			±5%	GRT1555C1E330JA02#	D1	
39pF			±5%	GRT1555C1E390JA02#	D1	
47pF			±5%	GRT1555C1E470JA02#	D1	
56pF			±5%	GRT1555C1E560JA02#	D1	
68pF			±5%	GRT1555C1E680JA02#	D1	
82pF			±5%	GRT1555C1E820JA02#	D1	
100pF			±5%	GRT1555C1E101JA02#	D1	
120pF			±5%	GRT1555C1E121JA02#	D1	
150pF			±5%	GRT1555C1E151JA02#	D1	
180pF			±5%	GRT1555C1E181JA02#	D1	
220pF			±5%	GRT1555C1E221JA02#	D1	
270pF			±5%	GRT1555C1E271JA02#	D1	

T max.	Rated Voltage	TC Code	Cap.	Tol.	Part Number	
0.55mm	25Vdc	COG	330pF	±5%	GRT1555C1E331JA02#	D1
			390pF	±5%	GRT1555C1E391JA02#	D1
			470pF	±5%	GRT1555C1E471JA02#	D1
			560pF	±5%	GRT1555C1E561JA02#	D1
			680pF	±5%	GRT1555C1E681JA02#	D1
			820pF	±5%	GRT1555C1E821JA02#	D1
			1000pF	±5%	GRT1555C1E102JA02#	D1

1.6×0.8mm

T max.	Rated Voltage	TC Code	Cap.	Tol.	Part Number	
0.9mm	100Vdc	COG	120pF	±5%	GRT1885C2A121JA02#	D1
			150pF	±5%	GRT1885C2A151JA02#	D1
			180pF	±5%	GRT1885C2A181JA02#	D1
			220pF	±5%	GRT1885C2A221JA02#	D1
			270pF	±5%	GRT1885C2A271JA02#	D1
			330pF	±5%	GRT1885C2A331JA02#	D1
			390pF	±5%	GRT1885C2A391JA02#	D1
			470pF	±5%	GRT1885C2A471JA02#	D1
			560pF	±5%	GRT1885C2A561JA02#	D1
			680pF	±5%	GRT1885C2A681JA02#	D1
			820pF	±5%	GRT1885C2A821JA02#	D1
			1000pF	±5%	GRT1885C2A102JA02#	D1
	50Vdc	COG	1200pF	±5%	GRT1885C1H122JA02#	D1
			1500pF	±5%	GRT1885C1H152JA02#	D1
			1800pF	±5%	GRT1885C1H182JA02#	D1
			2200pF	±5%	GRT1885C1H222JA02#	D1
			2700pF	±5%	GRT1885C1H272JA02#	D1
			3300pF	±5%	GRT1885C1H332JA02#	D1
			3900pF	±5%	GRT1885C1H392JA02#	D1
			4700pF	±5%	GRT1885C1H472JA02#	D1
			5600pF	±5%	GRT1885C1H562JA02#	D1
			6800pF	±5%	GRT1885C1H682JA02#	D1
			8200pF	±5%	GRT1885C1H822JA02#	D1
			10000pF	±5%	GRT1885C1H103JA02#	D1
25Vdc	COG	1200pF	±5%	GRT1885C1E122JA02#	D1	
		1500pF	±5%	GRT1885C1E152JA02#	D1	
		4700pF	±5%	GRT1885C1E472JA02#	D1	
		5600pF	±5%	GRT1885C1E562JA02#	D1	
		6800pF	±5%	GRT1885C1E682JA02#	D1	
		8200pF	±5%	GRT1885C1E822JA02#	D1	
		10000pF	±5%	GRT1885C1E103JA02#	D1	

2.0×1.25mm

T max.	Rated Voltage	TC Code	Cap.	Tol.	Part Number	
0.6mm	25Vdc	COG	1800pF	±5%	GRT2165C1E182JA12#	D1
			2200pF	±5%	GRT2165C1E222JA12#	D1
0.7mm	100Vdc	COG	1800pF	±5%	GRT2165C2A182JA02#	D1
			2200pF	±5%	GRT2165C2A222JA02#	D1

Part number # indicates the package specification code.

GRT Series  
 GCM Series  
 GC3 Series  
 GCJ Series  
 GCQ Series  
 GCD Series  
 GCE Series  
 NMF Series  
 KCM Series  
 KC3 Series  
 KCA Series  
 GCG Series  
 △Caution /Notice

GRT Series

GCM Series

GC3 Series

GCJ Series

GCQ Series

GCD Series

GCE Series

NMF Series

KCM Series

KC3 Series

KCA Series

GCG Series

⚠Caution/  
 Notice

# GRT Series Temperature Compensating Type Part Number List

(→ 2.0×1.25mm)

T max.	Rated Voltage	TC Code	Cap.	Tol.	Part Number	
0.7mm	100Vdc	COG	2700pF	±5%	GRT2165C2A272JA02#	<b>D1</b>
			3300pF	±5%	GRT2165C2A332JA02#	<b>D1</b>
1.35mm	50Vdc	COG	18000pF	±5%	GRT21B5C1H183JA02#	<b>D1</b>
			22000pF	±5%	GRT21B5C1H223JA02#	<b>D1</b>

## 3.2×1.6mm

T max.	Rated Voltage	TC Code	Cap.	Tol.	Part Number			
0.95mm	100Vdc	COG	3900pF	±5%	GRT3195C2A392JA02#	<b>D1</b>		
			4700pF	±5%	GRT3195C2A472JA02#	<b>D1</b>		
			5600pF	±5%	GRT3195C2A562JA02#	<b>D1</b>		
			6800pF	±5%	GRT3195C2A682JA02#	<b>D1</b>		
			8200pF	±5%	GRT3195C2A822JA02#	<b>D1</b>		
			10000pF	±5%	GRT3195C2A103JA02#	<b>D1</b>		
			18000pF	±5%	GRT3195C2A183JA02#	<b>D1</b>		
			22000pF	±5%	GRT3195C2A223JA02#	<b>D1</b>		
1.8mm	100Vdc	COG	0.10μF	±5%	GRT31C5C2A104JA12#	<b>D1</b>		
			50Vdc	COG	56000pF	±5%	GRT31C5C1H563JA02#	<b>D1</b>
					68000pF	±5%	GRT31C5C1H683JA02#	<b>D1</b>
					82000pF	±5%	GRT31C5C1H823JA02#	<b>D1</b>
	0.10μF	±5%			GRT31C5C1H104JA02#	<b>D1</b>		
	25Vdc	COG	0.10μF	±5%	GRT31C5C1E104JA02#	<b>D1</b>		
			0.12μF	±5%	GRT31C5C1E124JA02#	<b>D1</b>		
	16Vdc	COG	0.12μF	±5%	GRT31C5C1C124JA02#	<b>D1</b>		

# GRT Series High Dielectric Constant Type Part Number List

## 0.6×0.3mm

T max.	Rated Voltage	TC Code	Cap.	Tol.	Part Number		
0.33mm	35Vdc	X5R	0.10μF	±10%	GRT033R6YA104KE01#	<b>D1</b>	
							25Vdc
	470pF	±10%	GRT033R71E471KE01#	<b>D1</b>			
	1000pF	±10%	GRT033R71E102KE01#	<b>D1</b>			
	16Vdc	X6S	150pF	±10%	GRT033C81E151KE01#	<b>D1</b>	
			470pF	±10%	GRT033C81E471KE01#	<b>D1</b>	
			1000pF	±10%	GRT033C81E102KE01#	<b>D1</b>	
			0.10μF	±10%	GRT033C81E104KE01#	<b>D1</b>	
		X5R	100pF	±10%	GRT033R61E101KE01#	<b>D1</b>	
			150pF	±10%	GRT033R61E151KE01#	<b>D1</b>	
			220pF	±10%	GRT033R61E221KE01#	<b>D1</b>	
			330pF	±10%	GRT033R61E331KE01#	<b>D1</b>	
			470pF	±10%	GRT033R61E471KE01#	<b>D1</b>	
			680pF	±10%	GRT033R61E681KE01#	<b>D1</b>	
			1000pF	±10%	GRT033R61E102KE01#	<b>D1</b>	
			4700pF	±10%	GRT033R61E472KE01#	<b>D1</b>	
			6800pF	±10%	GRT033R61E682KE01#	<b>D1</b>	
			10000pF	±10%	GRT033R61E103KE01#	<b>D1</b>	
	0.10μF	±10%	GRT033R61E104KE01#	<b>D1</b>			
	10Vdc	X7S	0.10μF	±10%	GRT033C71C104KE01#	<b>D1</b>	
			0.10μF	±10%	GRT033C81C104KE01#	<b>D1</b>	
		X5R	10000pF	±10%	GRT033R61C103KE01#	<b>D1</b>	
			15000pF	±10%	GRT033R61C153KE01#	<b>D1</b>	
			22000pF	±10%	GRT033R61C223KE01#	<b>D1</b>	
			33000pF	±10%	GRT033R61C333KE01#	<b>D1</b>	
			47000pF	±10%	GRT033R61C473KE01#	<b>D1</b>	
			68000pF	±10%	GRT033R61C683KE01#	<b>D1</b>	
			0.10μF	±10%	GRT033R61C104KE01#	<b>D1</b>	
	6.3Vdc	X7R	10000pF	±10%	GRT033R71A103KE01#	<b>D1</b>	
			0.10μF	±10%	GRT033C71A104KE01#	<b>D1</b>	
			0.10μF	±10%	GRT033C81A104KE01#	<b>D1</b>	
			X5R	1500pF	±10%	GRT033R61A152KE01#	<b>D1</b>
				2200pF	±10%	GRT033R61A222KE01#	<b>D1</b>
				3300pF	±10%	GRT033R61A332KE01#	<b>D1</b>
				4700pF	±10%	GRT033R61A472KE01#	<b>D1</b>
				6800pF	±10%	GRT033R61A682KE01#	<b>D1</b>
				10000pF	±10%	GRT033R61A103KE01#	<b>D1</b>
				15000pF	±10%	GRT033R61A153KE01#	<b>D1</b>
		22000pF		±10%	GRT033R61A223KE01#	<b>D1</b>	
		33000pF		±10%	GRT033R61A333KE01#	<b>D1</b>	
		47000pF		±10%	GRT033R61A473KE01#	<b>D1</b>	
		68000pF		±10%	GRT033R61A683KE01#	<b>D1</b>	
		0.10μF		±10%	GRT033R61A104KE01#	<b>D1</b>	
		0.22μF	±10%	GRT033R61A224KE01#	<b>D1</b>		
X7S		2200pF	±10%	GRT033R70J222KE01#	<b>D1</b>		
		3300pF	±10%	GRT033R70J332KE01#	<b>D1</b>		
		4700pF	±10%	GRT033R70J472KE01#	<b>D1</b>		
		6800pF	±10%	GRT033R70J682KE01#	<b>D1</b>		
		10000pF	±10%	GRT033R70J103KE01#	<b>D1</b>		
		X7S	0.10μF	±10%	GRT033C70J104KE01#	<b>D1</b>	
	X6S		2200pF	±10%	GRT033C80J222KE01#	<b>D1</b>	
			3300pF	±10%	GRT033C80J332KE01#	<b>D1</b>	

T max.	Rated Voltage	TC Code	Cap.	Tol.	Part Number				
0.33mm	6.3Vdc	X6S	4700pF	±10%	GRT033C80J472KE01#	<b>D1</b>			
			6800pF	±10%	GRT033C80J682KE01#	<b>D1</b>			
			10000pF	±10%	GRT033C80J103KE01#	<b>D1</b>			
			15000pF	±10%	GRT033C80J153KE01#	<b>D1</b>			
			22000pF	±10%	GRT033C80J223KE01#	<b>D1</b>			
			33000pF	±10%	GRT033C80J333KE01#	<b>D1</b>			
			47000pF	±10%	GRT033C80J473KE01#	<b>D1</b>			
			68000pF	±10%	GRT033C80J683KE01#	<b>D1</b>			
			0.10μF	±10%	GRT033C80J104KE01#	<b>D1</b>			
			0.22μF	±10%	GRT033C80J224KE01#	<b>D1</b>			
			X5R	10000pF	±10%	GRT033R60J103KE01#	<b>D1</b>		
				15000pF	±10%	GRT033R60J153KE01#	<b>D1</b>		
				22000pF	±10%	GRT033R60J223KE01#	<b>D1</b>		
				33000pF	±10%	GRT033R60J333KE01#	<b>D1</b>		
				47000pF	±10%	GRT033R60J473KE01#	<b>D1</b>		
				68000pF	±10%	GRT033R60J683KE01#	<b>D1</b>		
	4Vdc	X6S	68000pF	±10%	GRT033C80G683KE01#	<b>D1</b>			
			0.10μF	±10%	GRT033C80G104KE01#	<b>D1</b>			
			0.22μF	±20%	GRT033C80G224ME01#	<b>D1</b>			
			0.35mm	6.3Vdc	X5R	1.0μF	±20%	GRT033R60J105ME13#	<b>D1</b>
				4Vdc	X5R	1.0μF	±20%	GRT033R60G105ME13#	<b>D1</b>
			0.39mm	10Vdc	X6S	1.0μF	±20%	GRT033C81A105ME13#	<b>D1</b>
6.3Vdc	X7T	1.0μF				±20%	GRT033D70J105ME13#	<b>D1</b>	
	X6S	1.0μF				±20%	GRT033C80J105ME13#	<b>D1</b>	
2.5Vdc	X7T	1.0μF		±20%	GRT033D70E105ME18#	<b>D1</b>			

## 1.0×0.5mm

T max.	Rated Voltage	TC Code	Cap.	Tol.	Part Number		
0.55mm	50Vdc	X7R	220pF	±10%	GRT155R71H221KE01#	<b>D1</b>	
			330pF	±10%	GRT155R71H331KE01#	<b>D1</b>	
			470pF	±10%	GRT155R71H471KE01#	<b>D1</b>	
			680pF	±10%	GRT155R71H681KE01#	<b>D1</b>	
			1000pF	±10%	GRT155R71H102KE01#	<b>D1</b>	
			1500pF	±10%	GRT155R71H152KE01#	<b>D1</b>	
			2200pF	±10%	GRT155R71H222KE01#	<b>D1</b>	
			3300pF	±10%	GRT155R71H332KE01#	<b>D1</b>	
			4700pF	±10%	GRT155R71H472KE01#	<b>D1</b>	
			6800pF	±10%	GRT155R71H682KE01#	<b>D1</b>	
			10000pF	±10%	GRT155R71H103KE01#	<b>D1</b>	
			15000pF	±10%	GRT155R71H153KE01#	<b>D1</b>	
			22000pF	±10%	GRT155R71H223KE01#	<b>D1</b>	
			33000pF	±10%	GRT155R71H333KE01#	<b>D1</b>	
			47000pF	±10%	GRT155R71H473KE01#	<b>D1</b>	
			68000pF	±10%	GRT155R71H683KE01#	<b>D1</b>	
			0.10μF	±10%	GRT155R71H104KE01#	<b>D1</b>	
			35Vdc	X6S	0.22μF	±10%	GRT155C8YA224KE01#
	X5R	0.22μF			±10%	GRT155R6YA224KE01#	<b>D1</b>
		0.47μF			±10%	GRT155R6YA474KE01#	<b>D1</b>

Part number # indicates the package specification code.

# GRT Series High Dielectric Constant Type Part Number List



(→ 1.0×0.5mm)

T max.	Rated Voltage	TC Code	Cap.	Tol.	Part Number						
0.55mm	25Vdc	X7R	1000pF	±10%	GRT155R71E103KE01#	<b>D1</b>					
			2200pF	±10%	GRT155R71E223KE01#	<b>D1</b>					
			3300pF	±10%	GRT155R71E333KE01#	<b>D1</b>					
			4700pF	±10%	GRT155R71E473KE01#	<b>D1</b>					
			0.10μF	±10%	GRT155R71E104KE01#	<b>D1</b>					
	16Vdc	X7R	1000pF	±10%	GRT155R71C103KE01#	<b>D1</b>					
			2200pF	±10%	GRT155R71C223KE01#	<b>D1</b>					
			3300pF	±10%	GRT155R71C333KE01#	<b>D1</b>					
			4700pF	±10%	GRT155R71C473KE01#	<b>D1</b>					
			6800pF	±10%	GRT155R71C683KE01#	<b>D1</b>					
10Vdc	X7R	0.10μF	±10%	GRT155R71C104KE01#	<b>D1</b>						
		0.22μF	±10%	GRT155R71C224KE01#	<b>D1</b>						
		0.47μF	±10%	GRT155R71C474KE01#	<b>D1</b>						
		1.0μF	±10%	GRT155R71C105KE01#	<b>D1</b>						
		6.3Vdc	X7R	0.22μF	±10%	GRT155R71A224KE01#	<b>D1</b>				
0.47μF	±10%			GRT155R71A474KE01#	<b>D1</b>						
1.0μF	±10%			GRT155R71A105KE01#	<b>D1</b>						
0.6mm	X5R			0.22μF	±10%	GRT155R61A224KE01#	<b>D1</b>				
				0.33μF	±10%	GRT155R61A334KE01#	<b>D1</b>				
		0.47μF	±10%	GRT155R61A474KE01#	<b>D1</b>						
		0.68μF	±10%	GRT155R61A684KE01#	<b>D1</b>						
		1.0μF	±10%	GRT155R61A105KE01#	<b>D1</b>						
0.65mm	X5R	2.2μF	±10%	GRT155R61A225KE01#	<b>D1</b>						
		4Vdc	X7R	1.0μF	±10%	GRT155R70J105KE01#	<b>D1</b>				
				35Vdc	X5R	0.22μF	±10%	GRT155C80J224KE01#	<b>D1</b>		
						0.33μF	±10%	GRT155C80J334KE01#	<b>D1</b>		
						0.47μF	±10%	GRT155C80J474KE01#	<b>D1</b>		
0.68μF	±10%					GRT155C80J684KE01#	<b>D1</b>				
1.0μF	±10%	GRT155C80J105KE01#	<b>D1</b>								
0.7mm	X5R	2.2μF	±10%	GRT155C80J225KE01#	<b>D1</b>						
		25Vdc	X5R	0.22μF	±10%	GRT155R60J224KE01#	<b>D1</b>				
				0.33μF	±10%	GRT155R60J334KE01#	<b>D1</b>				
				0.47μF	±10%	GRT155R60J474KE01#	<b>D1</b>				
				0.68μF	±10%	GRT155R60J684KE01#	<b>D1</b>				
1.0μF	±10%			GRT155R60J105KE01#	<b>D1</b>						
0.7mm	X6S	2.2μF	±10%	GRT155C81C225KE13#	<b>D1</b>						
		4Vdc	X5R	1.0μF	±10%	GRT155R70G105KE01#	<b>D1</b>				
				35Vdc	X5R	1.0μF	±10%	GRT155R60Y105KE13#	<b>D1</b>		
						25Vdc	X6S	1.0μF	±10%	GRT155C81E105KE13#	<b>D1</b>
						16Vdc	X6S	1.0μF	±10%	GRT155C81C105KE13#	<b>D1</b>
10Vdc	X7S					1.0μF	±10%	GRT155C71A105KE13#	<b>D1</b>		
6.3Vdc	X5R	4.7μF	±20%			GRT155R60J475ME13#	<b>D1</b>				
0.65mm	X5R	4.7μF	±20%	GRT155R60G475ME13#	<b>D1</b>						
		4Vdc	X5R	4.7μF	±20%	GRT155R60G475ME13#	<b>D1</b>				
				10Vdc	X5R	4.7μF	±20%	GRT155R61A475ME13#	<b>D1</b>		
						6.3Vdc	X6S	4.7μF	±20%	GRT155C80J475ME13#	<b>D1</b>
						25Vdc	X5R	2.2μF	±10%	GRT155R61E225KE13#	<b>D1</b>
16Vdc	X6S					2.2μF	±10%	GRT155C81C225KE13#	<b>D1</b>		

T max.	Rated Voltage	TC Code	Cap.	Tol.	Part Number	
0.7mm	16Vdc	X5R	2.2μF	±10%	GRT155R61C225KE13#	<b>D1</b>
		X7S	2.2μF	±10%	GRT155C71A225KE13#	<b>D1</b>
	10Vdc	X6S	2.2μF	±10%	GRT155C81A225KE13#	<b>D1</b>
		X7S	2.2μF	±10%	GRT155C70J225KE13#	<b>D1</b>
	2.5Vdc	X6S	10μF	±20%	GRT155C80E106ME13#	<b>D1</b>

1.6×0.8mm

T max.	Rated Voltage	TC Code	Cap.	Tol.	Part Number						
0.9mm	100Vdc	X7R	3300pF	±10%	GRT188R72A332KE01#	<b>D1</b>					
			10000pF	±10%	GRT188R72A103KE01#	<b>D1</b>					
		50Vdc	X5R	1.0μF	±10%	GRT188R61H105KE13#	<b>D1</b>				
				35Vdc	X6S	1.0μF	±10%	GRT188C8YA105KE13#	<b>D1</b>		
					X5R	2.2μF	±10%	GRT188R6YA225KE13#	<b>D1</b>		
	25Vdc	X7R	0.15μF	±10%	GRT188R71E154KE01#	<b>D1</b>					
			0.22μF	±10%	GRT188R71E224KE01#	<b>D1</b>					
			0.47μF	±10%	GRT188R71E474KE13#	<b>D1</b>					
			1.0μF	±10%	GRT188R71E105KE13#	<b>D1</b>					
			16Vdc	X7R	0.33μF	±10%	GRT188R71C334KE01#	<b>D1</b>			
0.47μF	±10%	GRT188R71C474KE01#			<b>D1</b>						
1.0μF	±10%	GRT188R71C105KE13#			<b>D1</b>						
6.3Vdc	X5R	10μF			±20%	GRT188R60J106ME13#	<b>D1</b>				
		4Vdc			X6S	1.0μF	±20%	GRT188C80G105ME01#	<b>D1</b>		
			4.7μF	±10%		GRT188C80G475KE01#	<b>D1</b>				
			10μF	±20%		GRT188C80G106ME13#	<b>D1</b>				
			X5R	10μF		±20%	GRT188R60G106ME13#	<b>D1</b>			
0.95mm	25Vdc		X5R	4.7μF		±10%	GRT188R61E475KE13#	<b>D1</b>			
		16Vdc		X6S	4.7μF	±10%	GRT188C81C475KE13#	<b>D1</b>			
					X5R	4.7μF	±10%	GRT188R61C475KE13#	<b>D1</b>		
	10Vdc	X5R	10μF	±10%	GRT188R61A106KE13#	<b>D1</b>					
			2.5Vdc	X5R	22μF	±20%	GRT188R60E226ME13#	<b>D1</b>			
1.0mm	50Vdc	X5R	2.2μF	±10%	GRT188R61H225KE13#	<b>D1</b>					
			35Vdc	X6S	2.2μF	±10%	GRT188C8YA225KE13#	<b>D1</b>			
					X5R	4.7μF	±10%	GRT188R6YA475KE13#	<b>D1</b>		
						25Vdc	X6S	2.2μF	±10%	GRT188C81E225KE13#	<b>D1</b>
								X5R	4.7μF	±10%	GRT188C81E475KE13#
	16Vdc	X6S	10μF	±20%	GRT188R61E106ME13#	<b>D1</b>					
			10Vdc	X7T	10μF	±20%	GRT188D71A106ME13#	<b>D1</b>			
					X6S	10μF	±20%	GRT188C81A106ME13#	<b>D1</b>		
						X5R	22μF	±20%	GRT188R61A226ME13#	<b>D1</b>	
							22μF	±20%	GRT188C80J226ME13#	<b>D1</b>	
6.3Vdc	X7T	10μF			±20%	GRT188D70J106ME13#	<b>D1</b>				
		X6S	10μF	±20%	GRT188C80J106ME13#	<b>D1</b>					
			22μF	±20%	GRT188C80J226ME13#	<b>D1</b>					
				X5R	22μF	±20%	GRT188R60J226ME13#	<b>D1</b>			
					X6S	22μF	±20%	GRT188C80G226ME13#	<b>D1</b>		

2.0×1.25mm

T max.	Rated Voltage	TC Code	Cap.	Tol.	Part Number	
0.95mm	16Vdc	X5R	3.3μF	±10%	GRT219R61C335KE01#	<b>D1</b>

Part number # indicates the package specification code.

## GRT Series High Dielectric Constant Type Info-tainment AEC-Q200 Part Number List

(→ 2.0×1.25mm)

T max.	Rated Voltage	TC Code	Cap.	Tol.	Part Number	
0.95mm	10Vdc	X6S	4.7μF	±10%	GRT219C81A475KE01#	<b>D1</b>
1.35mm	100Vdc	X7R	47000pF	±10%	GRT21BR72A473KE01#	<b>D1</b>
	50Vdc	X7R	0.47μF	±10%	GRT21BR71H474KE01#	<b>D1</b>
			1.0μF	±10%	GRT21BR71H105KE01#	<b>D1</b>
16Vdc	X7R	2.2μF	±10%	GRT21BR71C225KE01#	<b>D1</b>	
1.4mm	50Vdc	X5R	4.7μF	±10%	GRT21BR61H475KE13#	<b>D1</b>
	35Vdc	X6S	4.7μF	±10%	GRT21BC8YA475KE13#	<b>D1</b>
	25Vdc	X7R	2.2μF	±10%	GRT21BR71E225KE13#	<b>D1</b>
		X6S	3.3μF	±10%	GRT21BC81E335KE13#	<b>D1</b>
	16Vdc	X7R	4.7μF	±10%	GRT21BR71C475KE13#	<b>D1</b>
		X6S	3.3μF	±10%	GRT21BC81C335KE13#	<b>D1</b>
	10Vdc	X7R	4.7μF	±10%	GRT21BR71A475KE13#	<b>D1</b>
		X5R	3.3μF	±10%	GRT21BR61A335KE13#	<b>D1</b>
	6.3Vdc	X5R	3.3μF	±10%	GRT21BR60J335KE13#	<b>D1</b>
	1.45mm	50Vdc	X7S	4.7μF	±10%	GRT21BC71H475KE13#
25Vdc		X7S	4.7μF	±10%	GRT21BC71E475KE13#	<b>D1</b>
			10μF	±10%	GRT21BC71E106KE13#	<b>D1</b>
		X5R	22μF	±20%	GRT21BR61E226ME13#	<b>D1</b>
16Vdc		X7S	10μF	±10%	GRT21BC71C106KE13#	<b>D1</b>
		X5R	22μF	±20%	GRT21BR61C226ME13#	<b>D1</b>
10Vdc		X7T	22μF	±20%	GRT21BD71A226ME13#	<b>D1</b>
		X6S	22μF	±20%	GRT21BC81A226ME13#	<b>D1</b>
6.3Vdc		X7T	22μF	±20%	GRT21BD70J226ME13#	<b>D1</b>
		X5R	47μF	±20%	GRT21BR60J476ME13#	<b>D1</b>
4Vdc		X6S	47μF	±20%	GRT21BC80G476ME13#	<b>D1</b>
		X5R	47μF	±20%	GRT21BR60G476ME13#	<b>D1</b>

3.2×2.5mm

T max.	Rated Voltage	TC Code	Cap.	Tol.	Part Number	
1.5mm	25Vdc	X5R	6.8μF	±10%	GRT32NR61E685KE01#	<b>D1</b>
2.2mm	50Vdc	X6S	3.3μF	±10%	GRT32DC81H335KE01#	<b>D1</b>
		X5R	3.3μF	±10%	GRT32DR61H335KE01#	<b>D1</b>
2.7mm	6.3Vdc	X5R	33μF	±20%	GRT32DR60J336ME01#	<b>D1</b>
		X7R	4.7μF	±10%	GRT32ER71H475KE01#	<b>D1</b>
	X6S	4.7μF	±10%	GRT32EC81H475KE01#	<b>D1</b>	
6.3Vdc	16Vdc	X6S	47μF	±10%	GRT32EC81C476KE13#	<b>D1</b>
		X6S	47μF	±10%	GRT32EC81A476KE13#	<b>D1</b>
	10Vdc	X7R	47μF	±10%	GRT32ER70J476KE13#	<b>D1</b>
		X7S	100μF	±20%	GRT32EC70J107ME13#	<b>D1</b>
	X5R	100μF	±20%	GRT32ER60J107ME13#	<b>D1</b>	

3.2×1.6mm

T max.	Rated Voltage	TC Code	Cap.	Tol.	Part Number	
1.25mm	50Vdc	X6S	1.0μF	±10%	GRT31MC81H105KE01#	<b>D1</b>
		X6S	1.5μF	±10%	GRT31MC81E155KE01#	<b>D1</b>
			X5R	1.5μF	±10%	GRT31MR61E155KE01#
	16Vdc	X6S	1.5μF	±10%	GRT31MC81C155KE01#	<b>D1</b>
			6.8μF	±10%	GRT31MC81C685KE01#	<b>D1</b>
		X5R	1.5μF	±10%	GRT31MR61C155KE01#	<b>D1</b>
1.8mm	50Vdc	X7R	2.2μF	±10%	GRT31CR71H225KE13#	<b>D1</b>
			X6S	1.5μF	±10%	GRT31CC81H155KE01#
		X6S	2.2μF	±10%	GRT31CC81H225KE01#	<b>D1</b>
			X5R	1.5μF	±10%	GRT31CR61H155KE01#
		X5R	10μF	±10%	GRT31CR61H106KE01#	<b>D1</b>
			10μF	±10%	GRT31CR61H106KE01#	<b>D1</b>
	35Vdc	X6S	10μF	±10%	GRT31CC8YA106KE01#	<b>D1</b>
		X5R	10μF	±10%	GRT31CR6YA106KE01#	<b>D1</b>
	25Vdc	X6S	10μF	±10%	GRT31CC81E106KE01#	<b>D1</b>
		X5R	3.3μF	±10%	GRT31CR61E335KE01#	<b>D1</b>
	16Vdc	X6S	22μF	±10%	GRT31CC81C226KE01#	<b>D1</b>
	10Vdc	X5R	47μF	±10%	GRT31CR61A476KE13#	<b>D1</b>
	6.3Vdc	X6S	47μF	±10%	GRT31CC80J476KE13#	<b>D1</b>
		X5R	15μF	±10%	GRT31CR60J156KE01#	<b>D1</b>

GRT Series

GCM Series

GC3 Series

GCJ Series

GCQ Series

GCD Series

GCE Series

NMF Series

KCM Series

KC3 Series

KCA Series

GCG Series

⚠Caution/  
 Notice

Chip Multilayer Ceramic Capacitors for Automotive

**GCM Series**



Capacitor for automotive applications such as power train and safety equipment.

Features

① Ideal for powertrains and safety devices in automotive.

This product can be used for safety devices, such as the drive system control for engine ECU, air bags, and ABS. This product has cleared test conditions more severe than that of general products (GRM Series) even in temperature cycle and humidity load tests.

	General Purpose GRM Series Maximum operating temperature: 125°C	GCM Series for Automotive Maximum operating temperature: 150°C
Items	Test Method	Test Method
Temperature Cycle	Temperature Cycle: 5 cycles	Temperature Cycle: 100 cycles (1,000 cycles for AEC-Q200 conforming products)
Humidity Loading	Test temperature: 40±2°C Test humidity: 90 to 95%RH Test time: 500 hours	Test temperature: 85±2°C Test humidity: 80 to 85%RH Test time: 500 hours (1,000 hours for AEC-Q200 conforming products)

② Can be used at 125°C and 150°C temperatures.

We also offer a lineup for 150°C that can be used in the engine room.

③ Sn plating is applied to the external electrodes; excellent solderability.

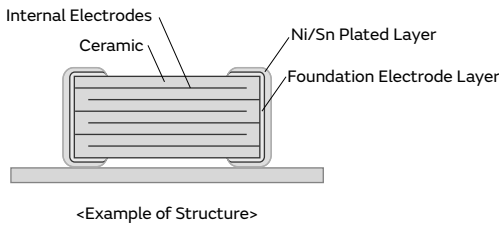

Specifications

Size	0.6×0.3mm to 5.7×5.0mm
Rated Voltage	4Vdc to 1000Vdc
Capacitance	0.10pF to 47μF
Main Applications	Safety equipment, such as drive system control, air bags, and ABS of engine ECU

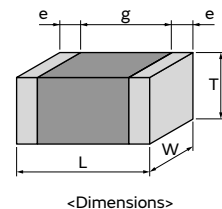

## GCM Series Temperature Compensating Type Power-train AEC-Q200 Part Number List

### 0.6×0.3mm

T max.	Rated Voltage	TC Code	Cap.	Tol.	Part Number			
0.33mm	50Vdc	COG	1.0pF	±0.25pF	GCM0335C1H1R0CA16#			
			2.0pF	±0.25pF	GCM0335C1H2R0CA16#			
			3.0pF	±0.25pF	GCM0335C1H3R0CA16#			
			4.0pF	±0.25pF	GCM0335C1H4R0CA16#			
			5.0pF	±0.25pF	GCM0335C1H5R0CA16#			
			6.0pF	±0.5pF	GCM0335C1H6R0DA16#			
			7.0pF	±0.5pF	GCM0335C1H7R0DA16#			
			8.0pF	±0.5pF	GCM0335C1H8R0DA16#			
			9.0pF	±0.5pF	GCM0335C1H9R0DA16#			
			10pF	±5%	GCM0335C1H100JA16#			
			12pF	±5%	GCM0335C1H120JA16#			
			15pF	±5%	GCM0335C1H150JA16#			
			18pF	±5%	GCM0335C1H180JA16#			
			22pF	±5%	GCM0335C1H220JA16#			
			27pF	±5%	GCM0335C1H270JA16#			
			33pF	±5%	GCM0335C1H330JA16#			
			39pF	±5%	GCM0335C1H390JA16#			
			47pF	±5%	GCM0335C1H470JA16#			
			56pF	±5%	GCM0335C1H560JA16#			
			68pF	±5%	GCM0335C1H680JA16#			
			82pF	±5%	GCM0335C1H820JA16#			
			100pF	±5%	GCM0335C1H101JA16#			
				25Vdc	COG	1.0pF	±0.25pF	GCM0335C1E1R0CA16#
						2.0pF	±0.25pF	GCM0335C1E2R0CA16#
						3.0pF	±0.25pF	GCM0335C1E3R0CA16#
						4.0pF	±0.25pF	GCM0335C1E4R0CA16#
						5.0pF	±0.25pF	GCM0335C1E5R0CA16#
						6.0pF	±0.5pF	GCM0335C1E6R0DA16#
						7.0pF	±0.5pF	GCM0335C1E7R0DA16#
						8.0pF	±0.5pF	GCM0335C1E8R0DA16#
						9.0pF	±0.5pF	GCM0335C1E9R0DA16#
						10pF	±5%	GCM0335C1E100JA16#
						12pF	±5%	GCM0335C1E120JA16#
						15pF	±5%	GCM0335C1E150JA16#
						18pF	±5%	GCM0335C1E180JA16#
						22pF	±5%	GCM0335C1E220JA16#
						27pF	±5%	GCM0335C1E270JA16#
						33pF	±5%	GCM0335C1E330JA16#
39pF	±5%	GCM0335C1E390JA16#						
47pF	±5%	GCM0335C1E470JA16#						
56pF	±5%	GCM0335C1E560JA16#						
68pF	±5%	GCM0335C1E680JA16#						
82pF	±5%	GCM0335C1E820JA16#						
100pF	±5%	GCM0335C1E101JA16#						

### 1.0×0.5mm

T max.	Rated Voltage	TC Code	Cap.	Tol.	Part Number
0.55mm	50Vdc	COG	1.0pF	±0.25pF	GCM1555C1H1R0CA16#
			2.0pF	±0.25pF	GCM1555C1H2R0CA16#
			3.0pF	±0.25pF	GCM1555C1H3R0CA16#

T max.	Rated Voltage	TC Code	Cap.	Tol.	Part Number			
0.55mm	50Vdc	COG	4.0pF	±0.25pF	GCM1555C1H4R0CA16#			
			5.0pF	±0.25pF	GCM1555C1H5R0CA16#			
			6.0pF	±0.5pF	GCM1555C1H6R0DA16#			
			7.0pF	±0.5pF	GCM1555C1H7R0DA16#			
			8.0pF	±0.5pF	GCM1555C1H8R0DA16#			
			9.0pF	±0.5pF	GCM1555C1H9R0DA16#			
			10pF	±5%	GCM1555C1H100JA16#			
			12pF	±5%	GCM1555C1H120JA16#			
			15pF	±5%	GCM1555C1H150JA16#			
			18pF	±5%	GCM1555C1H180JA16#			
			22pF	±5%	GCM1555C1H220JA16#			
			27pF	±5%	GCM1555C1H270JA16#			
			33pF	±5%	GCM1555C1H330JA16#			
			39pF	±5%	GCM1555C1H390JA16#			
			47pF	±5%	GCM1555C1H470JA16#			
			56pF	±5%	GCM1555C1H560JA16#			
			68pF	±5%	GCM1555C1H680JA16#			
			82pF	±5%	GCM1555C1H820JA16#			
			100pF	±5%	GCM1555C1H101JA16#			
			120pF	±5%	GCM1555C1H121JA16#			
			150pF	±5%	GCM1555C1H151JA16#			
			180pF	±5%	GCM1555C1H181JA16#			
			220pF	±5%	GCM1555C1H221JA16#			
			270pF	±5%	GCM1555C1H271JA16#			
			330pF	±5%	GCM1555C1H331JA16#			
			390pF	±5%	GCM1555C1H391JA16#			
			470pF	±5%	GCM1555C1H471JA16#			
			560pF	±5%	GCM1555C1H561JA16#			
			680pF	±5%	GCM1555C1H681JA16#			
			820pF	±5%	GCM1555C1H821JA16#			
			1000pF	±5%	GCM1555C1H102JA16#			
					X8G	1.0pF	±0.25pF	GCM1555G1H1R0CA16#
						2.0pF	±0.25pF	GCM1555G1H2R0CA16#
						3.0pF	±0.25pF	GCM1555G1H3R0CA16#
						4.0pF	±0.25pF	GCM1555G1H4R0CA16#
						5.0pF	±0.25pF	GCM1555G1H5R0CA16#
						12pF	±5%	GCM1555G1H120JA16#
						15pF	±5%	GCM1555G1H150JA16#
						18pF	±5%	GCM1555G1H180JA16#
						22pF	±5%	GCM1555G1H220JA16#
						27pF	±5%	GCM1555G1H270JA16#
						33pF	±5%	GCM1555G1H330JA16#
						39pF	±5%	GCM1555G1H390JA16#
						47pF	±5%	GCM1555G1H470JA16#
						56pF	±5%	GCM1555G1H560JA16#
						68pF	±5%	GCM1555G1H680JA16#
						82pF	±5%	GCM1555G1H820JA16#
						100pF	±5%	GCM1555G1H101JA16#
						120pF	±5%	GCM1555G1H121JA16#
						150pF	±5%	GCM1555G1H151JA16#
						180pF	±5%	GCM1555G1H181JA16#
						220pF	±5%	GCM1555G1H221JA16#
						270pF	±5%	GCM1555G1H271JA16#
			330pF	±5%	GCM1555G1H331JA16#			

Part number # indicates the package specification code.

GRT Series  
 GCM Series  
 GC3 Series  
 GCJ Series  
 GCQ Series  
 GCD Series  
 GCE Series  
 NMF Series  
 KCM Series  
 KC3 Series  
 KCA Series  
 GCG Series  
 ⚠Caution/  
 Notice

# GCM Series Temperature Compensating Type Part Number List

(→ 1.0×0.5mm)

T max.	Rated Voltage	TC Code	Cap.	Tol.	Part Number
0.55mm	50Vdc	X8G	390pF	±5%	GCM1555G1H391JA16#
			470pF	±5%	GCM1555G1H471JA16#
			560pF	±5%	GCM1555G1H561JA16#
			680pF	±5%	GCM1555G1H681JA16#
			820pF	±5%	GCM1555G1H821JA16#
			1000pF	±5%	GCM1555G1H102JA16#

1.6×0.8mm

T max.	Rated Voltage	TC Code	Cap.	Tol.	Part Number			
0.9mm	100Vdc	COG	1.0pF	±0.25pF	GCM1885C2A1R0CA16#			
			2.0pF	±0.25pF	GCM1885C2A2R0CA16#			
			3.0pF	±0.25pF	GCM1885C2A3R0CA16#			
			4.0pF	±0.25pF	GCM1885C2A4R0CA16#			
			5.0pF	±0.25pF	GCM1885C2A5R0CA16#			
			6.0pF	±0.5pF	GCM1885C2A6R0DA16#			
			7.0pF	±0.5pF	GCM1885C2A7R0DA16#			
			8.0pF	±0.5pF	GCM1885C2A8R0DA16#			
			9.0pF	±0.5pF	GCM1885C2A9R0DA16#			
			10pF	±5%	GCM1885C2A100JA16#			
			12pF	±5%	GCM1885C2A120JA16#			
			15pF	±5%	GCM1885C2A150JA16#			
			18pF	±5%	GCM1885C2A180JA16#			
			22pF	±5%	GCM1885C2A220JA16#			
			27pF	±5%	GCM1885C2A270JA16#			
			33pF	±5%	GCM1885C2A330JA16#			
			39pF	±5%	GCM1885C2A390JA16#			
			47pF	±5%	GCM1885C2A470JA16#			
			56pF	±5%	GCM1885C2A560JA16#			
			68pF	±5%	GCM1885C2A680JA16#			
			82pF	±5%	GCM1885C2A820JA16#			
			100pF	±5%	GCM1885C2A101JA16#			
			120pF	±5%	GCM1885C2A121JA16#			
			150pF	±5%	GCM1885C2A151JA16#			
			180pF	±5%	GCM1885C2A181JA16#			
			220pF	±5%	GCM1885C2A221JA16#			
			270pF	±5%	GCM1885C2A271JA16#			
			330pF	±5%	GCM1885C2A331JA16#			
			390pF	±5%	GCM1885C2A391JA16#			
			470pF	±5%	GCM1885C2A471JA16#			
			560pF	±5%	GCM1885C2A561JA16#			
			680pF	±5%	GCM1885C2A681JA16#			
			820pF	±5%	GCM1885C2A821JA16#			
			1000pF	±5%	GCM1885C2A102JA16#			
			1200pF	±5%	GCM1885C2A122JA16#			
			1500pF	±5%	GCM1885C2A152JA16#			
			U2J			1000pF	±5%	GCM1887U2A102JA16#
						1200pF	±5%	GCM1887U2A122JA16#
						1500pF	±5%	GCM1887U2A152JA16#
						1800pF	±5%	GCM1887U2A182JA16#
						2200pF	±5%	GCM1887U2A222JA16#
						2700pF	±5%	GCM1887U2A272JA16#
			3300pF	±5%	GCM1887U2A332JA16#			

T max.	Rated Voltage	TC Code	Cap.	Tol.	Part Number		
0.9mm	100Vdc	U2J	3900pF	±5%	GCM1887U2A392JA16#		
			4700pF	±5%	GCM1887U2A472JA16#		
			5600pF	±5%	GCM1887U2A562JA16#		
			6800pF	±5%	GCM1887U2A682JA16#		
			8200pF	±5%	GCM1887U2A822JA16#		
			10000pF	±5%	GCM1887U2A103JA16#		
			80Vdc	COG	1800pF	±5%	GCM1885C1K182JA16#
					2200pF	±5%	GCM1885C1K222JA16#
					2700pF	±5%	GCM1885C1K272JA16#
					3900pF	±5%	GCM1885C1K392JA16#
	50Vdc	COG			1200pF	±5%	GCM1885C1H122JA16#
					1500pF	±5%	GCM1885C1H152JA16#
			1800pF	±5%	GCM1885C1H182JA16#		
			2200pF	±5%	GCM1885C1H222JA16#		
			2700pF	±5%	GCM1885C1H272JA16#		
			3300pF	±5%	GCM1885C1H332JA16#		
			3900pF	±5%	GCM1885C1H392JA16#		
			4700pF	±5%	GCM1885C1H472JA16#		
			5600pF	±5%	GCM1885C1H562JA16#		
			6800pF	±5%	GCM1885C1H682JA16#		
	8200pF	±5%	GCM1885C1H822JA16#				
	10000pF	±5%	GCM1885C1H103JA16#				
	U2J			1000pF	±5%	GCM1887U1H102JA16#	
				1200pF	±5%	GCM1887U1H122JA16#	
				1500pF	±5%	GCM1887U1H152JA16#	
				1800pF	±5%	GCM1887U1H182JA16#	
				2200pF	±5%	GCM1887U1H222JA16#	
				2700pF	±5%	GCM1887U1H272JA16#	
				3300pF	±5%	GCM1887U1H332JA16#	
				3900pF	±5%	GCM1887U1H392JA16#	
				4700pF	±5%	GCM1887U1H472JA16#	
				5600pF	±5%	GCM1887U1H562JA16#	
	6800pF	±5%	GCM1887U1H682JA16#				
	8200pF	±5%	GCM1887U1H822JA16#				
	10000pF	±5%	GCM1887U1H103JA16#				

2.0×1.25mm

T max.	Rated Voltage	TC Code	Cap.	Tol.	Part Number		
0.7mm	100Vdc	COG	1800pF	±5%	GCM2165C2A182JA16#		
			2200pF	±5%	GCM2165C2A222JA16#		
			2700pF	±5%	GCM2165C2A272JA16#		
			3300pF	±5%	GCM2165C2A332JA16#		
			80Vdc	COG	4700pF	±5%	GCM2165C1K472JA16#
0.95mm	100Vdc	ZLM	1000pF	±10%	GCM2199E2A102KA05#		
				±20%	GCM2199E2A102MA05#		
			1100pF	±10%	GCM2199E2A112KA05#		
				±20%	GCM2199E2A112MA05#		
			1200pF	±10%	GCM2199E2A122KA05#		
				±20%	GCM2199E2A122MA05#		
			1300pF	±10%	GCM2199E2A132KA05#		
				±20%	GCM2199E2A132MA05#		
			1500pF	±10%	GCM2199E2A152KA05#		

Part number # indicates the package specification code.



# GCM Series Temperature Compensating Type Part Number List

(→ 2.0×1.25mm)

T max.	Rated Voltage	TC Code	Cap.	Tol.	Part Number			
0.95mm	100Vdc	ZLM	1500pF	±20%	GCM2199E2A152MA05#			
		COG	6800pF	±5%	GCM2195C1K682JA16#			
			8200pF	±5%	GCM2195C1K822JA16#			
			10000pF	±5%	GCM2195C1K103JA16#			
			12000pF	±5%	GCM2195C1K123JA16#			
	50Vdc	COG	15000pF	±5%	GCM2195C1K153JA16#			
			12000pF	±5%	GCM2195C1H123JA16#			
			15000pF	±5%	GCM2195C1H153JA16#			
			1.0mm	630Vdc	COG	10pF	±5%	GCM21A5C2J100JX01#
						15pF	±5%	GCM21A5C2J150JX01#
22pF	±5%	GCM21A5C2J220JX01#						
33pF	±5%	GCM21A5C2J330JX01#						
47pF	±5%	GCM21A5C2J470JX01#						
68pF	±5%	GCM21A5C2J680JX01#						
100pF	±5%	GCM21A5C2J101JX01#						
150pF	±5%	GCM21A5C2J151JX01#						
220pF	±5%	GCM21A5C2J221JX01#						
330pF	±5%	GCM21A5C2J331JX01#						
250Vdc	COG	470pF	±5%	GCM21A5C2J471JX01#				
		10pF	±5%	GCM21A5C2E100JX01#				
		15pF	±5%	GCM21A5C2E150JX01#				
		22pF	±5%	GCM21A5C2E220JX01#				
		33pF	±5%	GCM21A5C2E330JX01#				
		47pF	±5%	GCM21A5C2E470JX01#				
		68pF	±5%	GCM21A5C2E680JX01#				
		100pF	±5%	GCM21A5C2E101JX01#				
		150pF	±5%	GCM21A5C2E151JX01#				
		220pF	±5%	GCM21A5C2E221JX01#				
		330pF	±5%	GCM21A5C2E331JX01#				
		470pF	±5%	GCM21A5C2E471JX01#				
		680pF	±5%	GCM21A5C2E681JX01#				
		1000pF	±5%	GCM21A5C2E102JX01#				
		1500pF	±5%	GCM21A5C2E152JX01#				
		2200pF	±5%	GCM21A5C2E222JX01#				
		U2J	COG	100pF	±5%	GCM21A7U2E101JX01#		
				150pF	±5%	GCM21A7U2E151JX01#		
				220pF	±5%	GCM21A7U2E221JX01#		
				330pF	±5%	GCM21A7U2E331JX01#		
				470pF	±5%	GCM21A7U2E471JX01#		
				680pF	±5%	GCM21A7U2E681JX01#		
				1000pF	±5%	GCM21A7U2E102JX01#		
				1500pF	±5%	GCM21A7U2E152JX01#		
				2200pF	±5%	GCM21A7U2E222JX01#		
				1.4mm	80Vdc	COG	18000pF	±5%
		22000pF	±5%				GCM21B5C1K223JA16#	
		50Vdc	COG		18000pF	±5%	GCM21B5C1H183JA16#	
					22000pF	±5%	GCM21B5C1H223JA16#	
					1.45mm	630Vdc	COG	680pF
1000pF	±5%							GCM21B5C2J102JX03#
1500pF	±5%	GCM21B5C2J152JX0A#						
2200pF	±5%	GCM21B5C2J222JX0A#						
250Vdc	COG	3300pF	±5%	GCM21B5C2E332JX01#				
		4700pF	±5%	GCM21B5C2E472JX01#				
			6800pF	±5%	GCM21B5C2E682JX0A#			

T max.	Rated Voltage	TC Code	Cap.	Tol.	Part Number
1.45mm	250Vdc	COG	10000pF	±5%	GCM21B5C2E103JX0A#
			3300pF	±5%	GCM21B7U2E332JX03#
		U2J	4700pF	±5%	GCM21B7U2E472JX03#

3.2×1.6mm

T max.	Rated Voltage	TC Code	Cap.	Tol.	Part Number			
0.95mm	100Vdc	COG	3900pF	±5%	GCM3195C2A392JA16#			
			4700pF	±5%	GCM3195C2A472JA16#			
			5600pF	±5%	GCM3195C2A562JA16#			
			6800pF	±5%	GCM3195C2A682JA16#			
			8200pF	±5%	GCM3195C2A822JA16#			
			10000pF	±5%	GCM3195C2A103JA16#			
			80Vdc	COG	27000pF	±5%	GCM3195C1K273JA16#	
					33000pF	±5%	GCM3195C1K333JA16#	
			1.0mm	1000Vdc	COG	10pF	±5%	GCM31A5C3A100JX01#
						15pF	±5%	GCM31A5C3A150JX01#
22pF	±5%	GCM31A5C3A220JX01#						
33pF	±5%	GCM31A5C3A330JX01#						
47pF	±5%	GCM31A5C3A470JX01#						
68pF	±5%	GCM31A5C3A680JX01#						
100pF	±5%	GCM31A5C3A101JX01#						
150pF	±5%	GCM31A5C3A151JX01#						
220pF	±5%	GCM31A5C3A221JX01#						
330pF	±5%	GCM31A5C3A331JX01#						
470pF	±5%	GCM31A5C3A471JX01#						
U2J	COG	10pF				±5%	GCM31A7U3A100JX01#	
		15pF				±5%	GCM31A7U3A150JX01#	
		22pF				±5%	GCM31A7U3A220JX01#	
		33pF				±5%	GCM31A7U3A330JX01#	
		47pF				±5%	GCM31A7U3A470JX01#	
		68pF				±5%	GCM31A7U3A680JX01#	
		100pF				±5%	GCM31A7U3A101JX01#	
		150pF				±5%	GCM31A7U3A151JX01#	
		220pF				±5%	GCM31A7U3A221JX01#	
		330pF				±5%	GCM31A7U3A331JX01#	
630Vdc	COG	10pF				±5%	GCM31A5C2J100JX01#	
		15pF				±5%	GCM31A5C2J150JX01#	
		22pF				±5%	GCM31A5C2J220JX01#	
		33pF				±5%	GCM31A5C2J330JX01#	
		47pF				±5%	GCM31A5C2J470JX01#	
		68pF				±5%	GCM31A5C2J680JX01#	
		100pF				±5%	GCM31A5C2J101JX01#	
		150pF				±5%	GCM31A5C2J151JX01#	
		220pF				±5%	GCM31A5C2J221JX01#	
		330pF	±5%	GCM31A5C2J331JX01#				
U2J	COG	10pF	±5%	GCM31A7U2J100JX01#				
		15pF	±5%	GCM31A7U2J150JX01#				
		22pF	±5%	GCM31A7U2J220JX01#				

Part number # indicates the package specification code.

## GCM Series Temperature Compensating Type Part Number List

(→ 3.2×1.6mm)

T max.	Rated Voltage	TC Code	Cap.	Tol.	Part Number		
1.0mm	630Vdc	U2J	33pF	±5%	GCM31A7U2J330JX01#		
			47pF	±5%	GCM31A7U2J470JX01#		
			68pF	±5%	GCM31A7U2J680JX01#		
			100pF	±5%	GCM31A7U2J101JX01#		
			150pF	±5%	GCM31A7U2J151JX01#		
			220pF	±5%	GCM31A7U2J221JX01#		
			330pF	±5%	GCM31A7U2J331JX01#		
			470pF	±5%	GCM31A7U2J471JX01#		
			680pF	±5%	GCM31A7U2J681JX01#		
			1000pF	±5%	GCM31A7U2J102JX01#		
			1500pF	±5%	GCM31A7U2J152JX01#		
			2200pF	±5%	GCM31A7U2J222JX01#		
			1.25mm	1000Vdc	COG	680pF	±5%
U2J	470pF	±5%				GCM31B7U3A471JX01#	
	680pF	±5%				GCM31B7U3A681JX01#	
630Vdc	COG	2200pF		±5%	GCM31B5C2J222JX01#		
		U2J		3300pF	±5%	GCM31B7U2J332JX01#	
250Vdc	U2J	6800pF		±5%	GCM31B7U2E682JX01#		
		10000pF		±5%	GCM31B7U2E103JX01#		
		1000Vdc		COG	1000pF	±5%	GCM31C5C3A102JX03#
					U2J	1000pF	±5%
630Vdc	COG	3300pF		±5%	GCM31C5C2J332JX03#		
		U2J	4700pF	±5%	GCM31C5C2J472JX03#		
			4700pF	±5%	GCM31C7U2J472JX03#		
250Vdc	COG	15000pF	±5%	GCM31C5C2E153JX03#			
		22000pF	±5%	GCM31C5C2E223JX03#			
		100Vdc	COG	68000pF	±5%	GCM31C5C2A683JE02#	
				82000pF	±5%	GCM31C5C2A823JE02#	
0.10μF	±5%			GCM31C5C2A104JE02#			
50Vdc	COG	68000pF	±5%	GCM31C5C1H683JA16#			
		82000pF	±5%	GCM31C5C1H823JA16#			
		0.10μF	±5%	GCM31C5C1H104JA16#			
				GCM31C5C1H104JA16#			

5.7×5.0mm

T max.	Rated Voltage	TC Code	Cap.	Tol.	Part Number
1.5mm	1000Vdc	U2J	6800pF	±5%	GCM55Q7U3A682JX01#
2.0mm	1000Vdc	U2J	10000pF	±5%	GCM55D7U3A103JX01#
			630Vdc	U2J	33000pF
	47000pF	±5%			GCM55D7U2J473JX01#

3.2×2.5mm

T max.	Rated Voltage	TC Code	Cap.	Tol.	Part Number
1.0mm	630Vdc	U2J	1500pF	±5%	GCM32A7U2J152JX01#
			2200pF	±5%	GCM32A7U2J222JX01#
1.5mm	1000Vdc	U2J	1500pF	±5%	GCM32Q7U3A152JX01#
	630Vdc	U2J	6800pF	±5%	GCM32Q7U2J682JX01#
2.0mm	1000Vdc	U2J	2200pF	±5%	GCM32D7U3A222JX01#
	630Vdc	U2J	10000pF	±5%	GCM32D7U2J103JX01#

4.5×3.2mm

T max.	Rated Voltage	TC Code	Cap.	Tol.	Part Number
1.5mm	1000Vdc	U2J	3300pF	±5%	GCM43Q7U3A332JX01#
2.0mm	1000Vdc	U2J	4700pF	±5%	GCM43D7U3A472JX01#
			630Vdc	U2J	15000pF
	22000pF	±5%			GCM43D7U2J223JX01#

Part number # indicates the package specification code.

# GCM Series High Dielectric Constant Type Part Number List

## 0.6×0.3mm

T max.	Rated Voltage	TC Code	Cap.	Tol.	Part Number
0.33mm	25Vdc	X7R	100pF	±10%	GCM033R71E101KA03#
			150pF	±10%	GCM033R71E151KA03#
			220pF	±10%	GCM033R71E221KA03#
			330pF	±10%	GCM033R71E331KA03#
			470pF	±10%	GCM033R71E471KA03#
			680pF	±10%	GCM033R71E681KA03#
			1000pF	±10%	GCM033R71E102KA03#
			1500pF	±10%	GCM033R71E152KA03#
			2200pF	±10%	GCM033R71E222KE02#
			3300pF	±10%	GCM033R71E332KE02#
	16Vdc	X7R	330pF	±10%	GCM033R71C331KA03#
			680pF	±10%	GCM033R71C681KA03#
			2200pF	±10%	GCM033R71C222KA55#
			3300pF	±10%	GCM033R71C332KA55#
			10Vdc	X7R	4700pF
6800pF	±10%	GCM033R71A682KA03#			
10000pF	±10%	GCM033R71A103KA03#			

## 1.0×0.5mm

T max.	Rated Voltage	TC Code	Cap.	Tol.	Part Number		
0.55mm	100Vdc	X7R	220pF	±10%	GCM155R72A221KA37#		
			330pF	±10%	GCM155R72A331KA37#		
			470pF	±10%	GCM155R72A471KA37#		
			680pF	±10%	GCM155R72A681KA37#		
			1000pF	±10%	GCM155R72A102KA37#		
			1500pF	±10%	GCM155R72A152KA37#		
			2200pF	±10%	GCM155R72A222KA37#		
			3300pF	±10%	GCM155R72A332KA37#		
			4700pF	±10%	GCM155R72A472KA37#		
			50Vdc	X8L	33000pF	±10%	GCM155L8EH333KE07# <b>D4</b>
					47000pF	±10%	GCM155L8EH473KE07# <b>D4</b>
					68000pF	±10%	GCM155L8EH683KE07# <b>D4</b>
					0.10μF	±10%	GCM155L8EH104KE07# <b>D4</b>
					X7R	220pF	±10%
				330pF		±10%	GCM155R71H331KA37#
	470pF	±10%		GCM155R71H471KA37#			
	680pF	±10%		GCM155R71H681KA37#			
	1000pF	±10%		GCM155R71H102KA37#			
	1500pF	±10%		GCM155R71H152KA37#			
	2200pF	±10%	GCM155R71H222KA37#				
	3300pF	±10%	GCM155R71H332KA37#				
	4700pF	±10%	GCM155R71H472KA37#				
	6800pF	±10%	GCM155R71H682KA55#				
	10000pF	±10%	GCM155R71H103KA55#				
	15000pF	±10%	GCM155R71H153KA55#				
22000pF	±10%	GCM155R71H223KA55#					
33000pF	±10%	GCM155R71H333KE02#					
47000pF	±10%	GCM155R71H473KE02#					
68000pF	±10%	GCM155R71H683KE02#					
0.10μF	±10%	GCM155R71H104KE02#					

T max.	Rated Voltage	TC Code	Cap.	Tol.	Part Number	
0.55mm	25Vdc	X8L	0.10μF	±10%	GCM155L81E104KE02#	
			X7R	10000pF	±10%	GCM155R71E103KA37#
				15000pF	±10%	GCM155R71E153KA55#
				22000pF	±10%	GCM155R71E223KA55#
				33000pF	±10%	GCM155R71E333KA55#
	47000pF	±10%		GCM155R71E473KA55#		
	16Vdc	X7R	33000pF	±10%	GCM155R71C333KA37#	
			47000pF	±10%	GCM155R71C473KA37#	
			68000pF	±10%	GCM155R71C683KA55#	
			0.10μF	±10%	GCM155R71C104KA55#	
0.15μF			±10%	GCM155R71C154KE02#		
0.6mm	10Vdc	X7S	0.47μF	±10%	GCM155C71A474KE36#	
			1.0μF	±10%	GCM155C71A105KE38#	
0.7mm	10Vdc	X7S	0.68μF	±10%	GCM155C71A684KE38#	

## 1.6×0.8mm

T max.	Rated Voltage	TC Code	Cap.	Tol.	Part Number
0.9mm	100Vdc	X7R	6800pF	±10%	GCM188R72A682KA37#
			10000pF	±10%	GCM188R72A103KA37#
			15000pF	±10%	GCM188R72A153KA37#
			22000pF	±10%	GCM188R72A223KA37#
	50Vdc	X7R	0.22μF	±10%	GCM188R71H224KA64#
			25Vdc	X7R	0.22μF
	0.47μF	±10%			GCM188R71E474KA64#
	1.0μF	±10%			GCM188R71E105KA64#
	16Vdc	X7R			0.33μF
			0.47μF	±10%	GCM188R71C474KA55#
6.3Vdc	X7R	1.0μF	±10%	GCM188R71C105KA64#	
		2.2μF	±10%	GCM188R70J225KE22#	
1.0mm	6.3Vdc	X7T	10μF	±20%	GCM188D70J106ME36#
			4Vdc	X7T	10μF

## 2.0×1.25mm

T max.	Rated Voltage	TC Code	Cap.	Tol.	Part Number		
0.95mm	100Vdc	X7R	33000pF	±10%	GCM219R72A333KA37#		
			50Vdc	X7R	0.33μF	±10%	GCM219R71H334KA55#
	25Vdc	X7R	0.47μF	±10%	GCM219R71E474KA55#		
			16Vdc	X7R	1.0μF	±10%	GCM219R71C105KA37#
			1.4mm	100Vdc	X7R	47000pF	±10%
68000pF	±10%	GCM21BR72A683KA37#					
0.10μF	±10%	GCM21BR72A104KA37#					
50Vdc	X7R	0.22μF		±10%	GCM21BR71H224KA37#		
		0.47μF		±10%	GCM21BR71H474KA55#		
35Vdc	X8L	2.2μF	±10%	GCM21BL8EG225KE07# <b>D4</b>			
		X7R	0.68μF	±10%	GCM21BR7YA684KA55#		
			1.0μF	±10%	GCM21BR7YA105KA55#		
	1.5μF	±10%	GCM21BR7YA155KA54#				
		X7S	2.2μF	±10%	GCM21BC7YA225KE02#		

Part number # indicates the package specification code.

# GCM Series High Dielectric Constant Type Part Number List

(→ 2.0×1.25mm)

T max.	Rated Voltage	TC Code	Cap.	Tol.	Part Number		
1.4mm	25Vdc	X8L	1.5μF	±10%	GCM21BL8EF155KA07#	<b>D4</b>	
		X7R	0.33μF	±10%	GCM21BR71E334KA37#		
			0.68μF	±10%	GCM21BR71E684KA55#		
			1.0μF	±10%	GCM21BR71E105KA56#		
			1.5μF	±10%	GCM21BR71E155KA54#		
			2.2μF	±10%	GCM21BR71E225KA73#		
	16Vdc	X7R	2.2μF	±10%	GCM21BR71C225KA64#		
			4.7μF	±10%	GCM21BR71C475KA73#		
	10Vdc	X7R	2.2μF	±10%	GCM21BR71A225KA37#		
			10μF	±10%	GCM21BR71A106KE22#		
		X7S	4.7μF	±10%	GCM21BC71A475KA73#		
	6.3Vdc	X7R	10μF	±10%	GCM21BR70J106KE22#		
	1.45mm	100Vdc	X7S	1.0μF	±10%	GCM21BC72A105KE36#	
		35Vdc	X8L	4.7μF	±10%	GCM21BL8EG475KE08#	<b>D4</b>
X7S			4.7μF	±10%	GCM21BC7YA475KE36#		
25Vdc		X8L	4.7μF	±10%	GCM21BL8EF475KE08#	<b>D4</b>	
		X7S	4.7μF	±10%	GCM21BC71E475KE36#		
16Vdc		X8M	10μF	±10%	GCM21BM8EE106KE08#	<b>D4</b>	
	X7S	10μF	±10%	GCM21BC71C106KE36#			

T max.	Rated Voltage	TC Code	Cap.	Tol.	Part Number	
2.85mm	25Vdc	X8L	22μF	±10%	GCM32EL8EF226KE08#	<b>D4</b>
		X7S	22μF	±10%	GCM32EC71E226KE36#	

## 3.2×1.6mm

T max.	Rated Voltage	TC Code	Cap.	Tol.	Part Number	
1.25mm	100Vdc	X7R	0.22μF	±10%	GCM31MR72A224KA37#	
	25Vdc	X8L	1.0μF	±10%	GCM31ML81E105KA37#	
1.8mm	100Vdc	X8L	2.2μF	±10%	GCM31CL8EL225KE07#	<b>D4</b>
		X7S	2.2μF	±10%	GCM31CC72A225KE02#	
	50Vdc	X8L	1.0μF	±10%	GCM31CL81H105KA55#	
		X7R	2.2μF	±10%	GCM31CR71H225KA55#	
		X7S	4.7μF	±10%	GCM31CC71H475KA03#	
	25Vdc	X8R	1.0μF	±10%	GCM31CR91E105KA37#	
		X7R	4.7μF	±10%	GCM31CR71E475KA55#	
	16Vdc	X7R	4.7μF	±10%	GCM31CR71C475KA37#	
			10μF	±10%	GCM31CR71C106KA64#	
	10Vdc	X7R	22μF	±10%	GCM31CR71A226KE02#	
6.3Vdc	X7R	22μF	±20%	GCM31CR70J226ME23#		
1.9mm	25Vdc	X7S	10μF	±10%	GCM31CC71E106KA03#	

## 3.2×2.5mm

T max.	Rated Voltage	TC Code	Cap.	Tol.	Part Number	
2.2mm	100Vdc	X8L	4.7μF	±10%	GCM32DL8EL475KE07#	<b>D4</b>
		X7S	4.7μF	±10%	GCM32DC72A475KE02#	
2.7mm	50Vdc	X8L	10μF	±10%	GCM32EL8EH106KA07#	<b>D4</b>
		X7R	4.7μF	±10%	GCM32ER71H475KA55#	
		X7S	10μF	±10%	GCM32EC71H106KA03#	
	35Vdc	X7S	10μF	±10%	GCM32EC7YA106KA03#	
	25Vdc	X7R	10μF	±10%	GCM32ER71E106KA57#	
	16Vdc	X7R	22μF	±20%	GCM32ER71C226ME19#	
	10Vdc	X7R	22μF	±20%	GCM32ER71A226ME12#	
		X7S	47μF	±10%	GCM32EC71A476KE02#	
	6.3Vdc	X7R	47μF	±20%	GCM32ER70J476ME19#	

Part number # indicates the package specification code.

GRT Series  
 GCM Series  
 GC3 Series  
 GCJ Series  
 GCQ Series  
 GCD Series  
 GCE Series  
 NMF Series  
 KCM Series  
 KC3 Series  
 KCA Series  
 GCG Series  
 ⚠Caution/ Notice

High Effective Capacitance & High Ripple Current Chip Multilayer Ceramic Capacitors for Automotive

**GC3 Series**



This is a high ripple resistance product for automotive excellent in DC bias characteristics.

Features

- ① When a DC bias is applied, a capacitance higher than conventional products (X7R characteristics) can be acquired.

When DC600V is applied, about twice the capacitance can be secured.

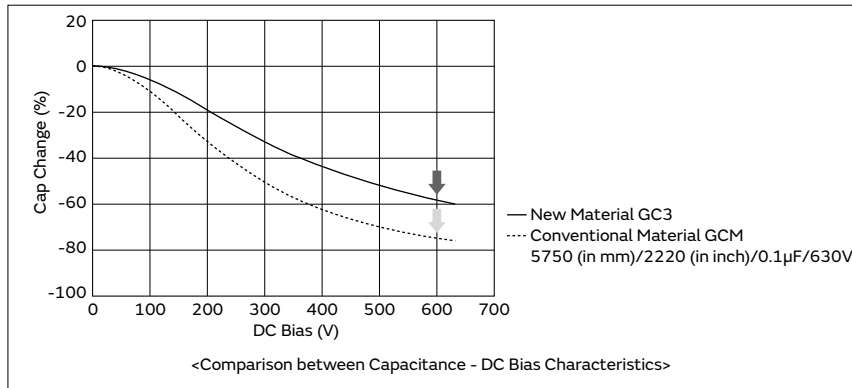

- ② Improved ripple resistance performance compared to conventional products (X7R characteristics).

In the case of a product with a capacitance of 0.1μF, when the exothermic temperature reaches 20°C at frequency f=300kHz, the amount of resistance of a product with conventional material is 1.8Arms; however, the new material is 2.3Arms.

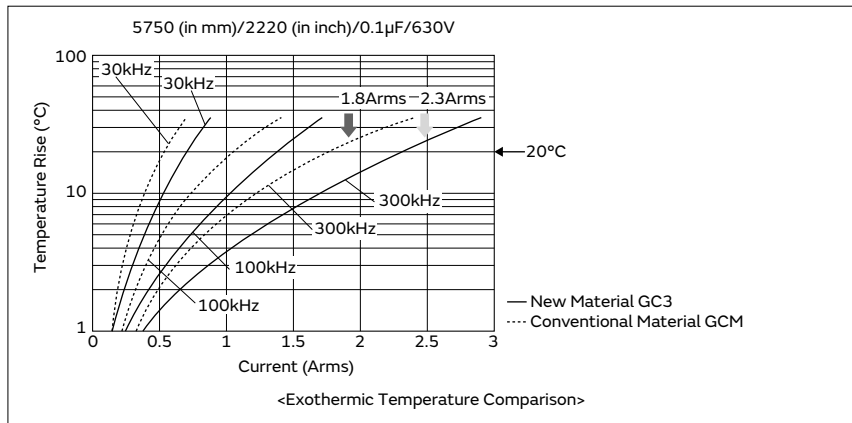

- ③ This product has a noise reduction effect.

Since dielectric materials that enable a reduction of noise are used, this product is more effective for reducing noise compared to the GCM series for automotive.

Specifications

Size	2.0×1.25mm to 5.7×5.0mm
Rated Voltage	250Vdc to 630Vdc
Capacitance	10000pF to 1.0μF
Main Applications	For PFC (Power Factor Correction) Circuits of Power Supplies, EMI Suppression and Smoothing Circuits of automotive

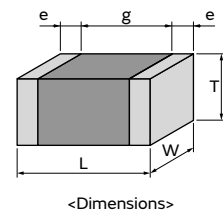

GRT Series  
 GCM Series  
 GC3 Series  
 GCJ Series  
 GCQ Series  
 GCD Series  
 GCE Series  
 NMF Series  
 KCM Series  
 KC3 Series  
 KCA Series  
 GCG Series  
 ⚠Caution /Notice

# GC3 Series High Dielectric Constant Type Part Number List

## 2.0×1.25mm

T max.	Rated Voltage	TC Code	Cap.	Tol.	Part Number
1.0mm	250Vdc	X7T	10000pF	±10%	GC321AD72E103KX01#
			15000pF	±10%	GC321AD72E153KX01#
1.45mm	250Vdc	X7T	22000pF	±10%	GC321BD72E223KX03#

T max.	Rated Voltage	TC Code	Cap.	Tol.	Part Number
2.7mm	250Vdc	X7T	1.0μF	±10%	GC355XD72E105KX05#

## 3.2×1.6mm

T max.	Rated Voltage	TC Code	Cap.	Tol.	Part Number
1.0mm	450Vdc	X7T	10000pF	±10%	GC331AD72W103KX01#
			15000pF	±10%	GC331AD72W153KX01#
	250Vdc	X7T	33000pF	±10%	GC331AD72E333KX01#
1.25mm	630Vdc	X7T	10000pF	±10%	GC331BD72J103KX01#
	450Vdc	X7T	22000pF	±10%	GC331BD72W223KX01#
			33000pF	±10%	GC331BD72W333KX01#
	250Vdc	X7T	47000pF	±10%	GC331BD72E473KX01#
1.8mm	630Vdc	X7T	15000pF	±10%	GC331CD72J153KX03#
	450Vdc	X7T	47000pF	±10%	GC331CD72W473KX03#
	250Vdc	X7T	68000pF	±10%	GC331CD72E683KX03#

## 3.2×2.5mm

T max.	Rated Voltage	TC Code	Cap.	Tol.	Part Number
1.5mm	630Vdc	X7T	22000pF	±10%	GC332QD72J223KX01#
	250Vdc	X7T	0.10μF	±10%	GC332QD72E104KX01#
2.0mm	630Vdc	X7T	33000pF	±10%	GC332DD72J333KX01#
			47000pF	±10%	GC332DD72J473KX01#
	450Vdc	X7T	68000pF	±10%	GC332DD72W683KX01#
			0.10μF	±10%	GC332DD72W104KX01#
	250Vdc	X7T	0.15μF	±10%	GC332DD72E154KX01#

## 4.5×3.2mm

T max.	Rated Voltage	TC Code	Cap.	Tol.	Part Number
1.5mm	250Vdc	X7T	0.22μF	±10%	GC343QD72E224KX01#
2.0mm	630Vdc	X7T	68000pF	±10%	GC343DD72J683KX01#
	450Vdc	X7T	0.15μF	±10%	GC343DD72W154KX01#
	250Vdc	X7T	0.33μF	±10%	GC343DD72E334KX01#

## 5.7×5.0mm

T max.	Rated Voltage	TC Code	Cap.	Tol.	Part Number
2.0mm	630Vdc	X7T	0.10μF	±10%	GC355DD72J104KX01#
			0.15μF	±10%	GC355DD72J154KX01#
	450Vdc	X7T	0.22μF	±10%	GC355DD72W224KX01#
			0.33μF	±10%	GC355DD72W334KX01#
			0.47μF	±10%	GC355DD72W474KX01#
	250Vdc	X7T	0.47μF	±10%	GC355DD72E474KX01#
0.68μF			±10%	GC355DD72E684KX01#	
2.7mm	630Vdc	X7T	0.22μF	±10%	GC355XD72J224KX05#

Part number # indicates the package specification code.

GRT Series  
 GCM Series  
 GC3 Series  
 GCJ Series  
 GCQ Series  
 GCD Series  
 GCE Series  
 NMF Series  
 KCM Series  
 KC3 Series  
 KCA Series  
 GCG Series  
 ⚠Caution/Notice

Soft Termination Chip Multilayer Ceramic Capacitors for Automotive

**GCJ Series**



**Cracking caused by flexing stress after board mounting is minimized due to resin external electrodes!**

Features

① The resin external electrodes suppress cracks by board deflection.

Cracking of the ceramic element is suppressed by the resin of the external electrodes, which releases the stress.

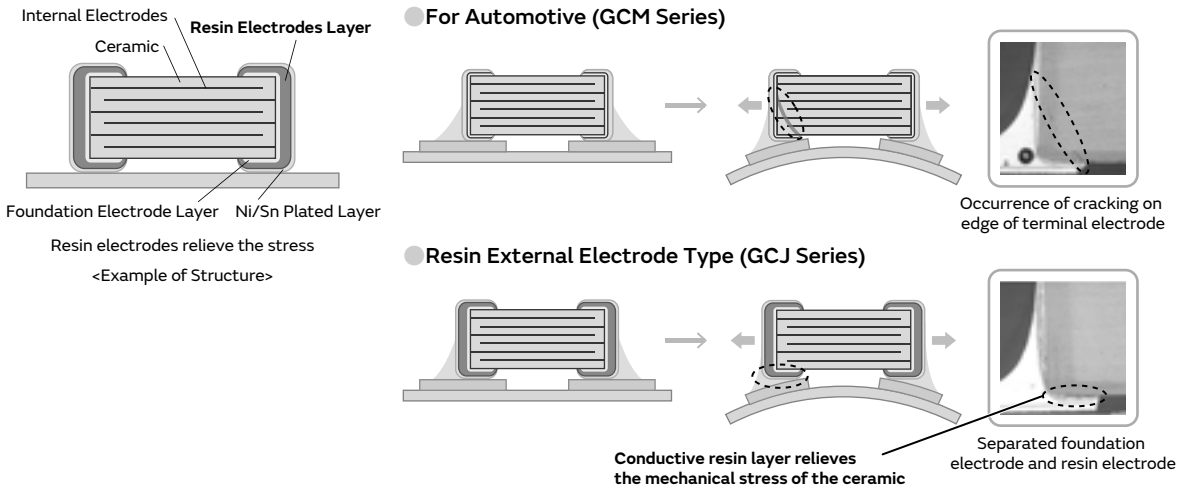

Note: Cracks may occur in the capacitor body if excessive stress beyond the "guaranteed range of board bending strength (\*)" provided in the specifications is applied. Capacitors with cracks in them may cause a drop in insulation resistance, which could lead to a short circuit.  
 (\*) For details on the guaranteed range of board bending strength, check the "Detailed Specification Sheet" on the Product Details Page.

② Suppresses the occurrence of cracking caused by deflection stress at the time of board mounting, etc.

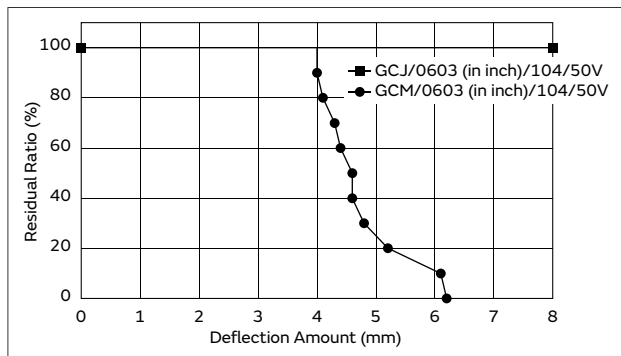

Products shall be judged to be defective if the change in capacitance has exceeded  $\pm 12.5\%$   
 The measurement specification is 8mm max.

③ Ideal for automotive.

The products conforms to the AEC-Q200.

Specifications

Size	1.6×0.8mm to 5.7×5.0mm
Rated Voltage	6.3Vdc to 1000Vdc
Capacitance	220pF to 47μF
Main Applications	Battery Lines and Powertrains for automotive

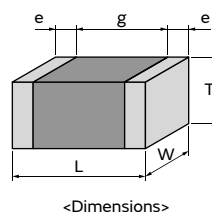

# GCJ Series High Dielectric Constant Type **Power-train** **AEC-Q200** **Fail safe** **Deflecting crack** Part Number List

1.6×0.8mm

T max.	Rated Voltage	TC Code	Cap.	Tol.	Part Number					
0.9mm	100Vdc	X8L	0.10μF	±10%	GCJ188L8EL104KA07#	<b>D4</b>				
			X8R	1000pF	±10%	GCJ188R92A102KA01#				
					1200pF	±10%	GCJ188R92A122KA01#			
					1500pF	±10%	GCJ188R92A152KA01#			
					1800pF	±10%	GCJ188R92A182KA01#			
					2200pF	±10%	GCJ188R92A222KA01#			
					2700pF	±10%	GCJ188R92A272KA01#			
					3300pF	±10%	GCJ188R92A332KA01#			
					3900pF	±10%	GCJ188R92A392KA01#			
					4700pF	±10%	GCJ188R92A472KA01#			
					5600pF	±10%	GCJ188R92A562KA01#			
					6800pF	±10%	GCJ188R92A682KA01#			
					8200pF	±10%	GCJ188R92A822KA01#			
					10000pF	±10%	GCJ188R92A103KA01#			
					12000pF	±10%	GCJ188R92A123KA01#			
					15000pF	±10%	GCJ188R92A153KA01#			
					18000pF	±10%	GCJ188R92A183KA01#			
					22000pF	±10%	GCJ188R92A223KA01#			
					27000pF	±10%	GCJ188R92A273KA01#			
					33000pF	±10%	GCJ188R92A333KA01#			
					39000pF	±10%	GCJ188R92A393KA01#			
					47000pF	±10%	GCJ188R92A473KA01#			
					56000pF	±10%	GCJ188R92A563KA01#			
					68000pF	±10%	GCJ188R92A683KA01#			
				X7R	1000pF	±10%	GCJ188R72A102KA01#			
						1200pF	±10%	GCJ188R72A122KA01#		
						1500pF	±10%	GCJ188R72A152KA01#		
						1800pF	±10%	GCJ188R72A182KA01#		
						2200pF	±10%	GCJ188R72A222KA01#		
						2700pF	±10%	GCJ188R72A272KA01#		
						3300pF	±10%	GCJ188R72A332KA01#		
						3900pF	±10%	GCJ188R72A392KA01#		
						4700pF	±10%	GCJ188R72A472KA01#		
						5600pF	±10%	GCJ188R72A562KA01#		
						6800pF	±10%	GCJ188R72A682KA01#		
						8200pF	±10%	GCJ188R72A822KA01#		
						10000pF	±10%	GCJ188R72A103KA01#		
						12000pF	±10%	GCJ188R72A123KA01#		
						15000pF	±10%	GCJ188R72A153KA01#		
						18000pF	±10%	GCJ188R72A183KA01#		
						22000pF	±10%	GCJ188R72A223KA01#		
						0.10μF	±10%	GCJ188R72A104KA01#		
			50Vdc	X8L	0.15μF	±10%	GCJ188L8EH154KA07#	<b>D4</b>		
					0.22μF	±10%	GCJ188L8EH224KA07#	<b>D4</b>		
					X8R	4700pF	±10%	GCJ188R91H472KA01#		
							10000pF	±10%	GCJ188R91H103KA01#	
							0.10μF	±10%	GCJ188R91H104KA01#	
							0.12μF	±10%	GCJ188R91H124KA01#	
							0.15μF	±10%	GCJ188R91H154KA01#	
							0.18μF	±10%	GCJ188R91H184KA01#	
							0.22μF	±10%	GCJ188R91H224KA01#	
						X7R	1000pF	±10%	GCJ188R71H102KA01#	

T max.	Rated Voltage	TC Code	Cap.	Tol.	Part Number					
0.9mm	50Vdc	X7R	1200pF	±10%	GCJ188R71H122KA01#					
			1500pF	±10%	GCJ188R71H152KA01#					
			1800pF	±10%	GCJ188R71H182KA01#					
			2200pF	±10%	GCJ188R71H222KA01#					
			2700pF	±10%	GCJ188R71H272KA01#					
			3300pF	±10%	GCJ188R71H332KA01#					
			3900pF	±10%	GCJ188R71H392KA01#					
			4700pF	±10%	GCJ188R71H472KA01#					
			5600pF	±10%	GCJ188R71H562KA01#					
			6800pF	±10%	GCJ188R71H682KA01#					
			8200pF	±10%	GCJ188R71H822KA01#					
			10000pF	±10%	GCJ188R71H103KA01#					
			12000pF	±10%	GCJ188R71H123KA01#					
			15000pF	±10%	GCJ188R71H153KA01#					
			18000pF	±10%	GCJ188R71H183KA01#					
			22000pF	±10%	GCJ188R71H223KA01#					
			33000pF	±10%	GCJ188R71H333KA12#					
			39000pF	±10%	GCJ188R71H393KA12#					
			47000pF	±10%	GCJ188R71H473KA12#					
			56000pF	±10%	GCJ188R71H563KA12#					
			68000pF	±10%	GCJ188R71H683KA12#					
			82000pF	±10%	GCJ188R71H823KA12#					
						0.10μF	±10%	GCJ188R71H104KA12#		
						0.15μF	±10%	GCJ188R71H154KA01#		
						0.22μF	±10%	GCJ188R71H224KA01#		
				35Vdc	X8L	33000pF	±10%	GCJ188L8YA333KA01#		
							39000pF	±10%	GCJ188L8YA393KA01#	
							56000pF	±10%	GCJ188L8YA563KA01#	
							68000pF	±10%	GCJ188L8YA683KA01#	
				25Vdc	X8L	33000pF	±10%	GCJ188L81E333KA01#		
							39000pF	±10%	GCJ188L81E393KA01#	
							56000pF	±10%	GCJ188L81E563KA01#	
							68000pF	±10%	GCJ188L81E683KA01#	
							82000pF	±10%	GCJ188L81E823KA01#	
							0.15μF	±10%	GCJ188L81E154KA01#	
							0.18μF	±10%	GCJ188L81E184KA01#	
							0.22μF	±10%	GCJ188L81E224KA01#	
						X8R	0.33μF	±10%	GCJ188R91E334KA01#	
								0.39μF	±10%	GCJ188R91E394KA01#
								0.47μF	±10%	GCJ188R91E474KA01#
						X7R	1000pF	±10%	GCJ188R71E102KA01#	
							1200pF	±10%	GCJ188R71E122KA01#	
							1500pF	±10%	GCJ188R71E152KA01#	
							1800pF	±10%	GCJ188R71E182KA01#	
							2200pF	±10%	GCJ188R71E222KA01#	
							2700pF	±10%	GCJ188R71E272KA01#	
							3300pF	±10%	GCJ188R71E332KA01#	
							3900pF	±10%	GCJ188R71E392KA01#	
			4700pF	±10%	GCJ188R71E472KA01#					
			5600pF	±10%	GCJ188R71E562KA01#					
			6800pF	±10%	GCJ188R71E682KA01#					
			8200pF	±10%	GCJ188R71E822KA01#					
			10000pF	±10%	GCJ188R71E103KA01#					
			12000pF	±10%	GCJ188R71E123KA01#					

Part number # indicates the package specification code.

GRT Series  
 GCM Series  
 GC3 Series  
**GCJ Series**  
 GCQ Series  
 GCD Series  
 GCE Series  
 NMF Series  
 KCM Series  
 KC3 Series  
 KCA Series  
 GCG Series  
 Caution/ Notice



# GCJ Series High Dielectric Constant Type Part Number List

(→ 1.6×0.8mm)

T max.	Rated Voltage	TC Code	Cap.	Tol.	Part Number	
0.9mm	25Vdc	X7R	1500pF	±10%	GCJ188R71E153KA01#	
			1800pF	±10%	GCJ188R71E183KA01#	
			2200pF	±10%	GCJ188R71E223KA01#	
			2700pF	±10%	GCJ188R71E273KA01#	
			3300pF	±10%	GCJ188R71E333KA01#	
			3900pF	±10%	GCJ188R71E393KA01#	
			4700pF	±10%	GCJ188R71E473KA01#	
			5600pF	±10%	GCJ188R71E563KA12#	
			6800pF	±10%	GCJ188R71E683KA12#	
			8200pF	±10%	GCJ188R71E823KA12#	
			0.10μF	±10%	GCJ188R71E104KA12#	
			0.12μF	±10%	GCJ188R71E124KA01#	
			0.15μF	±10%	GCJ188R71E154KA01#	
			0.18μF	±10%	GCJ188R71E184KA12#	
			0.22μF	±10%	GCJ188R71E224KA12#	
			1.0μF	±10%	GCJ188R71E105KA01#	
	16Vdc	X8L	0.22μF	±10%	GCJ188L81C224KA01#	
			2700pF	±10%	GCJ188R71C273KA01#	
		X7R	3300pF	±10%	GCJ188R71C333KA01#	
			3900pF	±10%	GCJ188R71C393KA01#	
			4700pF	±10%	GCJ188R71C473KA01#	
			5600pF	±10%	GCJ188R71C563KA01#	
			6800pF	±10%	GCJ188R71C683KA01#	
			8200pF	±10%	GCJ188R71C823KA01#	
			0.10μF	±10%	GCJ188R71C104KA01#	
			0.12μF	±10%	GCJ188R71C124KA01#	
			0.15μF	±10%	GCJ188R71C154KA01#	
			0.18μF	±10%	GCJ188R71C184KA01#	
			0.22μF	±10%	GCJ188R71C224KA01#	
			0.27μF	±10%	GCJ188R71C274KA01#	
			0.33μF	±10%	GCJ188R71C334KA01#	
			0.39μF	±10%	GCJ188R71C394KA12#	
	0.47μF	±10%	GCJ188R71C474KA12#			
	10Vdc	X7R	0.22μF	±10%	GCJ188R71A224KA01#	
	6.3Vdc	X7R	2.2μF	±10%	GCJ188R70J225KE01#	
	1.0mm	6.3Vdc	X8L	3.3μF	±10%	GCJ188L8EC335KE08#
X8M			4.7μF	±10%	GCJ188M8EC475KE08#	<b>D4</b>
X7S			3.3μF	±10%	GCJ188C70J335KE02#	
			4.7μF	±10%	GCJ188C70J475KE02#	

2.0×1.25mm

T max.	Rated Voltage	TC Code	Cap.	Tol.	Part Number	
0.95mm	100Vdc	X7R	2700pF	±10%	GCJ219R72A273KA01#	
			3300pF	±10%	GCJ219R72A333KA01#	
			3900pF	±10%	GCJ219R72A393KA01#	
	50Vdc	X7R	0.33μF	±10%	GCJ219R71H334KA12#	
	25Vdc	X7R	0.33μF	±10%	GCJ219R71E334KA01#	
			0.47μF	±10%	GCJ219R71E474KA12#	
	16Vdc	X7R	0.68μF	±10%	GCJ219R71C684KA01#	
			0.82μF	±10%	GCJ219R71C824KA01#	
			1.0μF	±10%	GCJ219R71C105KA01#	
	1.0mm	250Vdc	X7R	1000pF	±10%	GCJ21AR72E102KXJ1#

T max.	Rated Voltage	TC Code	Cap.	Tol.	Part Number		
1.0mm	250Vdc	X7R	1500pF	±10%	GCJ21AR72E152KXJ1#		
			2200pF	±10%	GCJ21AR72E222KXJ1#		
			3300pF	±10%	GCJ21AR72E332KXJ1#		
			4700pF	±10%	GCJ21AR72E472KXJ1#		
			6800pF	±10%	GCJ21AR72E682KXJ1#		
			1.45mm	250Vdc	X7R	1000pF	±10%
1500pF	±10%	GCJ21BR72E153KXJ3#					
2200pF	±10%	GCJ21BR72E223KXJ3#					
100Vdc	X7R	4700pF	±10%		GCJ21BR72A473KA01#		
		5600pF	±10%		GCJ21BR72A563KA01#		
		6800pF	±10%		GCJ21BR72A683KA01#		
		8200pF	±10%	GCJ21BR72A823KA01#			
50Vdc	X8L	8200pF	±10%	GCJ21BL81H823KA01#			
		0.10μF	±10%	GCJ21BL81H104KA01#			
	X7R	0.47μF	±10%	GCJ21BL8EH474KA07#	<b>D4</b>		
		0.22μF	±10%	GCJ21BR71H224KA01#			
35Vdc	X8L	0.47μF	±10%	GCJ21BR71H474KA12#			
		1.0μF	±10%	GCJ21BR71H105KA01#			
		0.12μF	±10%	GCJ21BL8YA124KA01#			
		0.15μF	±10%	GCJ21BL8YA154KA01#			
		0.18μF	±10%	GCJ21BL8YA184KA01#			
		0.22μF	±10%	GCJ21BL8YA224KA01#			
		0.33μF	±10%	GCJ21BL8YA334KA01#			
		0.47μF	±10%	GCJ21BL8YA474KA01#			
		25Vdc	X8L	0.12μF	±10%	GCJ21BL81E124KA01#	
				0.15μF	±10%	GCJ21BL81E154KA01#	
0.18μF	±10%			GCJ21BL81E184KA01#			
0.22μF	±10%			GCJ21BL81E224KA01#			
0.27μF	±10%			GCJ21BL81E274KA01#			
0.33μF	±10%			GCJ21BL81E334KA01#			
0.39μF	±10%			GCJ21BL81E394KA01#			
0.47μF	±10%			GCJ21BL81E474KA01#			
0.68μF	±10%			GCJ21BL81E684KA01#			
0.82μF	±10%			GCJ21BL81E824KA01#			
16Vdc	X8L	0.56μF	±10%	GCJ21BL81C564KA01#			
		0.68μF	±10%	GCJ21BL81C684KA01#			
		0.82μF	±10%	GCJ21BL81C824KA01#			
		1.0μF	±10%	GCJ21BL81C105KA01#			
		0.27μF	±10%	GCJ21BR71C274KA01#			
	X7R	0.33μF	±10%	GCJ21BR71C334KA01#			
		0.39μF	±10%	GCJ21BR71C394KA01#			
		0.47μF	±10%	GCJ21BR71C474KA01#			
		0.56μF	±10%	GCJ21BR71C564KA01#			
		1.0μF	±10%	GCJ21BR71C105KA01#			

Part number # indicates the package specification code.

# GCJ Series High Dielectric Constant Type **Powertrain** **AEC-Q200** **Fail safe** **Deflecting crack** Part Number List

(→ 2.0×1.25mm)

T max.	Rated Voltage	TC Code	Cap.	Tol.	Part Number
1.45mm	16Vdc	X7R	2.2µF	±10%	GCJ21BR71C225KA13#
			4.7µF	±10%	GCJ21BR71C475KA01#
	10Vdc	X7R	2.2µF	±10%	GCJ21BR71A225KA01#
			10µF	±10%	GCJ21BR71A106KE01#
1.5mm	100Vdc	X7S	1.0µF	±10%	GCJ21BC72A105KE02#

## 3.2×1.6mm

T max.	Rated Voltage	TC Code	Cap.	Tol.	Part Number
1.25mm	1000Vdc	X7R	1000pF	±10%	GCJ31BR73A102KXJ1#
			1500pF	±10%	GCJ31BR73A152KXJ1#
			2200pF	±10%	GCJ31BR73A222KXJ1#
			3300pF	±10%	GCJ31BR73A332KXJ1#
			4700pF	±10%	GCJ31BR73A472KXJ1#
630Vdc	X7R	1000pF	±10%	GCJ31BR72J102KXJ1#	
		1500pF	±10%	GCJ31BR72J152KXJ1#	
		2200pF	±10%	GCJ31BR72J222KXJ1#	
		3300pF	±10%	GCJ31BR72J332KXJ1#	
		4700pF	±10%	GCJ31BR72J472KXJ1#	
		6800pF	±10%	GCJ31BR72J682KXJ1#	
250Vdc	X7R	15000pF	±10%	GCJ31BR72E153KXJ1#	
		22000pF	±10%	GCJ31BR72E223KXJ1#	
		68000pF	±10%	GCJ31BR72E683KXJ1#	
1.35mm	100Vdc	X7R	0.15µF	±10%	GCJ31MR72A154KA01#
			0.18µF	±10%	GCJ31MR72A184KA01#
			0.22µF	±10%	GCJ31MR72A224KA01#
50Vdc	X7R	0.47µF	±10%	GCJ31MR71H474KA01#	
		0.56µF	±10%	GCJ31MR71H564KA12#	
		0.68µF	±10%	GCJ31MR71H684KA12#	
		0.82µF	±10%	GCJ31MR71H824KA12#	
		1.0µF	±10%	GCJ31MR71H105KA12#	
25Vdc	X7R	2.2µF	±10%	GCJ31MR71E225KA12#	
		3.3µF	±10%	GCJ31MR71E335KA12#	
1.8mm	1000Vdc	X7R	6800pF	±10%	GCJ31CR73A682KXJ3#
			10000pF	±10%	GCJ31CR73A103KXJ3#
	630Vdc	X7R	15000pF	±10%	GCJ31CR72J153KXJ3#
			22000pF	±10%	GCJ31CR72J223KXJ3#
	250Vdc	X7R	33000pF	±10%	GCJ31CR72E333KXJ3#
47000pF			±10%	GCJ31CR72E473KXJ3#	
0.10µF			±10%	GCJ31CR72E104KXJ3#	
1.9mm	100Vdc	X8L	1.0µF	±10%	GCJ31CL8EL105KA07# <b>D4</b>
		X7R	1.0µF	±10%	GCJ31CR72A105KA01#
		X7S	2.2µF	±10%	GCJ31CC72A225KE01#
	50Vdc	X7R	1.5µF	±10%	GCJ31CR71H155KA12#
			2.2µF	±10%	GCJ31CR71H225KA12#
			X7S	4.7µF	±10%
	35Vdc	X8L	0.56µF	±10%	GCJ31CL8YA564KA01#
			0.68µF	±10%	GCJ31CL8YA684KA01#
			0.82µF	±10%	GCJ31CL8YA824KA01#
1.0µF			±10%	GCJ31CL8YA105KA01#	
25Vdc	X7R	4.7µF	±10%	GCJ31CR71E475KA12#	
16Vdc	X8L	3.3µF	±10%	GCJ31CL81C335KA01#	

T max.	Rated Voltage	TC Code	Cap.	Tol.	Part Number
1.9mm	16Vdc	X8L	4.7µF	±10%	GCJ31CL81C475KA01#
			X7R	3.3µF	±10%
		X7R	4.7µF	±10%	GCJ31CR71C475KA01#
			10µF	±10%	GCJ31CR71C106KA15#
	10Vdc	X8L	22µF	±10%	GCJ31CL8ED226KE07# <b>D4</b>
			X7R	6.8µF	±10%
		X7R	10µF	±10%	GCJ31CR71A106KA13#
			22µF	±10%	GCJ31CR71A226KE01#
6.3Vdc	X7R	22µF	±10%	GCJ31CR70J226KE01#	
2.0mm	25Vdc	X8L	10µF	±10%	GCJ31CL8EF106KA08# <b>D4</b>
		X7S	10µF	±10%	GCJ31CC71E106KA15#

## 3.2×2.5mm

T max.	Rated Voltage	TC Code	Cap.	Tol.	Part Number
1.5mm	630Vdc	X7R	6800pF	±10%	GCJ32QR72J682KXJ1#
			10000pF	±10%	GCJ32QR72J103KXJ1#
	250Vdc	X7R	68000pF	±10%	GCJ32QR72E683KXJ1#
2.0mm	1000Vdc	X7R	15000pF	±10%	GCJ32DR73A153KXJ1#
			22000pF	±10%	GCJ32DR73A223KXJ1#
	630Vdc	X7R	15000pF	±10%	GCJ32DR72J153KXJ1#
			22000pF	±10%	GCJ32DR72J223KXJ1#
			33000pF	±10%	GCJ32DR72J333KXJ1#
250Vdc	X7R	47000pF	±10%	GCJ32DR72J473KXJ1#	
		0.10µF	±10%	GCJ32DR72E104KXJ1#	
0.22µF	±10%			GCJ32DR72E224KXJ1#	
2.3mm	100Vdc	X8L	2.2µF	±10%	GCJ32DL8EL225KA07# <b>D4</b>
		X7R	2.2µF	±10%	GCJ32DR72A225KA01#
		X7S	4.7µF	±10%	GCJ32DC72A475KE01#
2.8mm	50Vdc	X7R	4.7µF	±10%	GCJ32ER71H475KA12#
			X7S	10µF	±10%
	25Vdc	X8L	4.7µF	±10%	GCJ32EL81E475KA01#
			X8R	6.8µF	±10%
	16Vdc	X8R	10µF	±10%	GCJ32ER91C106KE01#
6.3Vdc	X7R	22µF	±10%	GCJ32ER71C226KE01#	
		47µF	±10%	GCJ32ER70J476KE01#	
		2.85mm	25Vdc	X8L	22µF
X7S	22µF	±10%	GCJ32EC71E226KE02#		

## 4.5×3.2mm

T max.	Rated Voltage	TC Code	Cap.	Tol.	Part Number
1.5mm	630Vdc	X7R	68000pF	±10%	GCJ43QR72J683KXJ1#
	250Vdc	X7R	0.15µF	±10%	GCJ43QR72E154KXJ1#
2.0mm	1000Vdc	X7R	33000pF	±10%	GCJ43DR73A333KXJ1#
			47000pF	±10%	GCJ43DR73A473KXJ1#
	630Vdc	X7R	33000pF	±10%	GCJ43DR72J333KXJ1#
			47000pF	±10%	GCJ43DR72J473KXJ1#
			0.10µF	±10%	GCJ43DR72J104KXJ1#
	250Vdc	X7R	0.22µF	±10%	GCJ43DR72E224KXJ1#
0.33µF			±10%	GCJ43DR72E334KXJ1#	

Part number # indicates the package specification code.

GRT Series  
 GCM Series  
 GC3 Series  
 GCJ Series  
 GCQ Series  
 GCD Series  
 GCE Series  
 NMF Series  
 KCM Series  
 KC3 Series  
 KCA Series  
 GCG Series  
 ⚠Caution/ Notice

# GCJ Series High Dielectric Constant Type Part Number List

(→ 4.5×3.2mm)

T max.	Rated Voltage	TC Code	Cap.	Tol.	Part Number
2.0mm	250Vdc	X7R	0.47μF	±10%	GCJ43DR72E474KXJ1#

5.7×5.0mm

T max.	Rated Voltage	TC Code	Cap.	Tol.	Part Number
2.0mm	1000Vdc	X7R	68000pF	±10%	GCJ55DR73A683KXJ1#
			0.10μF	±10%	GCJ55DR73A104KXJ1#
	630Vdc	X7R	0.10μF	±10%	GCJ55DR72J104KXJ1#
			0.15μF	±10%	GCJ55DR72J154KXJ1#
			0.22μF	±10%	GCJ55DR72J224KXJ1#
	250Vdc	X7R	0.33μF	±10%	GCJ55DR72E334KXJ1#
			0.47μF	±10%	GCJ55DR72E474KXJ1#
			0.68μF	±10%	GCJ55DR72E684KXJ1#
			1.0μF	±10%	GCJ55DR72E105KXJ1#

GRT Series

GCM Series

GC3 Series

GCJ Series

GCQ Series

GCD Series

GCE Series

NMF Series

KCM Series

KC3 Series

KCA Series

GCG Series

⚠Caution /Notice

GRT Series

GCM Series

GC3 Series

GCJ Series

GCQ Series

GCD Series

GCE Series

NMF Series

KCM Series

KC3 Series

KCA Series

GCG Series

⚠Caution/ Notice

High Q Chip Multilayer Ceramic Capacitors for Automotive

**GCQ Series**



This product improves the high frequency characteristics and contributes to a reduction of power consumption by the High Q and low ESR. Capacitor for automotive applications such as power train and safety equipment.

Features

① High Q and Low ESR were achieved at a "high frequency," which is ideal for matching applications.

High Q and Low ESR were achieved at a high frequency, by adopting a ceramic material with extremely low loss at a high frequency as the dielectric material, and copper for the internal electrodes. This product is ideal for matching applications.



<Example of Structure>

② This is a High Q capacitor for V2X, ADAS, and automotive communication applications which conform to AEC-Q200.

The self-resonant frequency of 5.9 GHz (for 2.2 pF products) is ideal for the DC-CUT in DSRC IEEE821.11p.

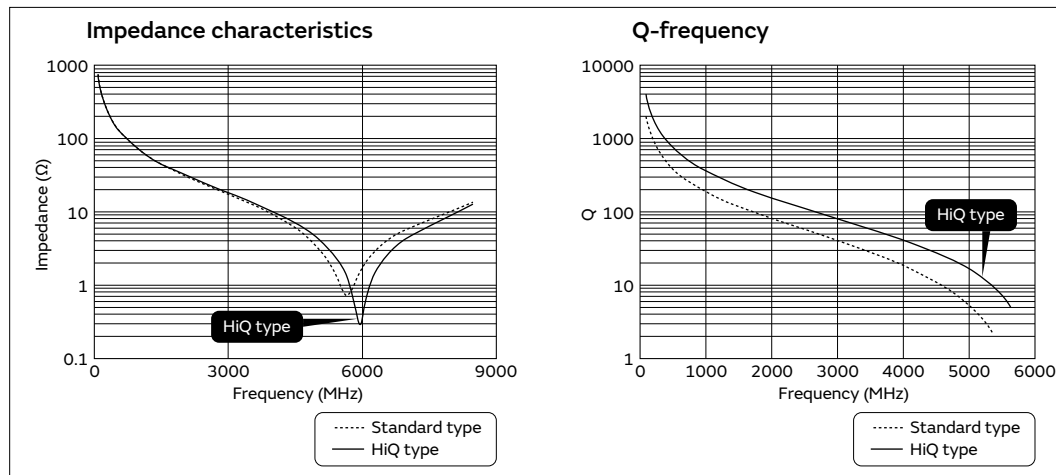

③ Can be used for tight tolerance.

In addition to standard tolerance, the allowable range of this product is also suitable for the following tight tolerance.

Capacitance Range	Standard Capacitance Tolerance (Capacitance Tolerance Symbol)	Narrow Capacitance Tolerance (Capacitance Tolerance Symbol)
to 0.9pF	±0.1pF (B)	±0.05pF (W)
1 to 5pF	±0.25pF (C)	±0.05pF (W), ±0.1pF (B)
5.1 to 9.9pF	±0.5pF (D)	±0.05pF (W), ±0.1pF (B), ±0.25pF (C)
10pF~	±5% (J)	±2% (G)

## Specifications

Size	1.0×0.5mm
Rated Voltage	50Vdc
Capacitance	0.10pF to 47μF
Main Applications	DC cut in the 5.9GHz of V2X applications, and RF matching RF matching in the other automotive communication applications

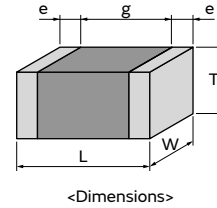

GRT Series

GCM Series

GC3 Series

GCJ Series

GCQ Series

GCD Series

GCE Series

NMF Series

KCM Series

KC3 Series

KCA Series

GCG Series

⚠Caution /Notice

51

# GCQ Series Temperature Compensating Type Part Number List

1.0×0.5mm

T max.	Rated Voltage	TC Code	Cap.	Tol.	Part Number
0.55mm	50Vdc	COG	0.10pF	±0.05pF	GCQ1555C1HR10WB01#
				±0.1pF	GCQ1555C1HR10BB01#
			0.20pF	±0.05pF	GCQ1555C1HR20WB01#
				±0.1pF	GCQ1555C1HR20BB01#
			0.30pF	±0.05pF	GCQ1555C1HR30WB01#
				±0.1pF	GCQ1555C1HR30BB01#
			0.40pF	±0.05pF	GCQ1555C1HR40WB01#
				±0.1pF	GCQ1555C1HR40BB01#
			0.50pF	±0.05pF	GCQ1555C1HR50WB01#
				±0.1pF	GCQ1555C1HR50BB01#
			0.60pF	±0.05pF	GCQ1555C1HR60WB01#
				±0.1pF	GCQ1555C1HR60BB01#
			0.70pF	±0.05pF	GCQ1555C1HR70WB01#
				±0.1pF	GCQ1555C1HR70BB01#
			0.80pF	±0.05pF	GCQ1555C1HR80WB01#
				±0.1pF	GCQ1555C1HR80BB01#
			0.90pF	±0.05pF	GCQ1555C1HR90WB01#
				±0.1pF	GCQ1555C1HR90BB01#
			1.0pF	±0.05pF	GCQ1555C1H1R0WB01#
				±0.1pF	GCQ1555C1H1R0BB01#
				±0.25pF	GCQ1555C1H1R0CB01#
			1.1pF	±0.05pF	GCQ1555C1H1R1WB01#
				±0.1pF	GCQ1555C1H1R1BB01#
				±0.25pF	GCQ1555C1H1R1CB01#
			1.2pF	±0.05pF	GCQ1555C1H1R2WB01#
				±0.1pF	GCQ1555C1H1R2BB01#
				±0.25pF	GCQ1555C1H1R2CB01#
			1.3pF	±0.05pF	GCQ1555C1H1R3WB01#
				±0.1pF	GCQ1555C1H1R3BB01#
				±0.25pF	GCQ1555C1H1R3CB01#
			1.4pF	±0.05pF	GCQ1555C1H1R4WB01#
				±0.1pF	GCQ1555C1H1R4BB01#
				±0.25pF	GCQ1555C1H1R4CB01#
			1.5pF	±0.05pF	GCQ1555C1H1R5WB01#
				±0.1pF	GCQ1555C1H1R5BB01#
				±0.25pF	GCQ1555C1H1R5CB01#
			1.6pF	±0.05pF	GCQ1555C1H1R6WB01#
				±0.1pF	GCQ1555C1H1R6BB01#
				±0.25pF	GCQ1555C1H1R6CB01#
			1.7pF	±0.05pF	GCQ1555C1H1R7WB01#
				±0.1pF	GCQ1555C1H1R7BB01#
				±0.25pF	GCQ1555C1H1R7CB01#
			1.8pF	±0.05pF	GCQ1555C1H1R8WB01#
				±0.1pF	GCQ1555C1H1R8BB01#
				±0.25pF	GCQ1555C1H1R8CB01#
			1.9pF	±0.05pF	GCQ1555C1H1R9WB01#
				±0.1pF	GCQ1555C1H1R9BB01#
				±0.25pF	GCQ1555C1H1R9CB01#
2.0pF	±0.05pF	GCQ1555C1H2R0WB01#			
	±0.1pF	GCQ1555C1H2R0BB01#			
	±0.25pF	GCQ1555C1H2R0CB01#			
2.1pF	±0.05pF	GCQ1555C1H2R1WB01#			

T max.	Rated Voltage	TC Code	Cap.	Tol.	Part Number
0.55mm	50Vdc	COG	2.1pF	±0.1pF	GCQ1555C1H2R1BB01#
				±0.25pF	GCQ1555C1H2R1CB01#
			2.2pF	±0.05pF	GCQ1555C1H2R2WB01#
				±0.1pF	GCQ1555C1H2R2BB01#
				±0.25pF	GCQ1555C1H2R2CB01#
				2.3pF	±0.05pF
			±0.1pF		GCQ1555C1H2R3BB01#
			±0.25pF		GCQ1555C1H2R3CB01#
			2.4pF	±0.05pF	GCQ1555C1H2R4WB01#
				±0.1pF	GCQ1555C1H2R4BB01#
				±0.25pF	GCQ1555C1H2R4CB01#
			2.5pF	±0.05pF	GCQ1555C1H2R5WB01#
				±0.1pF	GCQ1555C1H2R5BB01#
				±0.25pF	GCQ1555C1H2R5CB01#
			2.6pF	±0.05pF	GCQ1555C1H2R6WB01#
				±0.1pF	GCQ1555C1H2R6BB01#
				±0.25pF	GCQ1555C1H2R6CB01#
			2.7pF	±0.05pF	GCQ1555C1H2R7WB01#
				±0.1pF	GCQ1555C1H2R7BB01#
				±0.25pF	GCQ1555C1H2R7CB01#
			2.8pF	±0.05pF	GCQ1555C1H2R8WB01#
				±0.1pF	GCQ1555C1H2R8BB01#
				±0.25pF	GCQ1555C1H2R8CB01#
			2.9pF	±0.05pF	GCQ1555C1H2R9WB01#
				±0.1pF	GCQ1555C1H2R9BB01#
				±0.25pF	GCQ1555C1H2R9CB01#
			3.0pF	±0.05pF	GCQ1555C1H3R0WB01#
				±0.1pF	GCQ1555C1H3R0BB01#
				±0.25pF	GCQ1555C1H3R0CB01#
			3.1pF	±0.05pF	GCQ1555C1H3R1WB01#
				±0.1pF	GCQ1555C1H3R1BB01#
				±0.25pF	GCQ1555C1H3R1CB01#
			3.2pF	±0.05pF	GCQ1555C1H3R2WB01#
				±0.1pF	GCQ1555C1H3R2BB01#
				±0.25pF	GCQ1555C1H3R2CB01#
			3.3pF	±0.05pF	GCQ1555C1H3R3WB01#
				±0.1pF	GCQ1555C1H3R3BB01#
				±0.25pF	GCQ1555C1H3R3CB01#
			3.4pF	±0.05pF	GCQ1555C1H3R4WB01#
				±0.1pF	GCQ1555C1H3R4BB01#
				±0.25pF	GCQ1555C1H3R4CB01#
			3.5pF	±0.05pF	GCQ1555C1H3R5WB01#
				±0.1pF	GCQ1555C1H3R5BB01#
				±0.25pF	GCQ1555C1H3R5CB01#
			3.6pF	±0.05pF	GCQ1555C1H3R6WB01#
				±0.1pF	GCQ1555C1H3R6BB01#
				±0.25pF	GCQ1555C1H3R6CB01#
			3.7pF	±0.05pF	GCQ1555C1H3R7WB01#
±0.1pF	GCQ1555C1H3R7BB01#				
±0.25pF	GCQ1555C1H3R7CB01#				
3.8pF	±0.05pF	GCQ1555C1H3R8WB01#			
	±0.1pF	GCQ1555C1H3R8BB01#			
	±0.25pF	GCQ1555C1H3R8CB01#			
3.9pF	±0.05pF	GCQ1555C1H3R9WB01#			

Part number # indicates the package specification code.

GRT Series  
 GCM Series  
 GC3 Series  
 GCJ Series  
 GCQ Series  
 GCD Series  
 GCE Series  
 NMF Series  
 KCM Series  
 KC3 Series  
 KCA Series  
 GCG Series  
 Caution/Notice

# GCQ Series Temperature Compensating Type Part Number List

(→ 1.0×0.5mm)

T max.	Rated Voltage	TC Code	Cap.	Tol.	Part Number
0.55mm	50Vdc	COG	3.9pF	±0.1pF	GCQ1555C1H3R9BB01#
				±0.25pF	GCQ1555C1H3R9CB01#
			4.0pF	±0.05pF	GCQ1555C1H4R0WB01#
				±0.1pF	GCQ1555C1H4R0BB01#
				±0.25pF	GCQ1555C1H4R0CB01#
				±0.5pF	GCQ1555C1H4R0DB01#
			4.1pF	±0.05pF	GCQ1555C1H4R1WB01#
				±0.1pF	GCQ1555C1H4R1BB01#
				±0.25pF	GCQ1555C1H4R1CB01#
			4.2pF	±0.05pF	GCQ1555C1H4R2WB01#
				±0.1pF	GCQ1555C1H4R2BB01#
				±0.25pF	GCQ1555C1H4R2CB01#
			4.3pF	±0.05pF	GCQ1555C1H4R3WB01#
				±0.1pF	GCQ1555C1H4R3BB01#
				±0.25pF	GCQ1555C1H4R3CB01#
			4.4pF	±0.05pF	GCQ1555C1H4R4WB01#
				±0.1pF	GCQ1555C1H4R4BB01#
				±0.25pF	GCQ1555C1H4R4CB01#
			4.5pF	±0.05pF	GCQ1555C1H4R5WB01#
				±0.1pF	GCQ1555C1H4R5BB01#
				±0.25pF	GCQ1555C1H4R5CB01#
			4.6pF	±0.05pF	GCQ1555C1H4R6WB01#
				±0.1pF	GCQ1555C1H4R6BB01#
				±0.25pF	GCQ1555C1H4R6CB01#
			4.7pF	±0.05pF	GCQ1555C1H4R7WB01#
				±0.1pF	GCQ1555C1H4R7BB01#
				±0.25pF	GCQ1555C1H4R7CB01#
			4.8pF	±0.05pF	GCQ1555C1H4R8WB01#
				±0.1pF	GCQ1555C1H4R8BB01#
				±0.25pF	GCQ1555C1H4R8CB01#
			4.9pF	±0.05pF	GCQ1555C1H4R9WB01#
				±0.1pF	GCQ1555C1H4R9BB01#
				±0.25pF	GCQ1555C1H4R9CB01#
			5.0pF	±0.05pF	GCQ1555C1H5R0WB01#
				±0.1pF	GCQ1555C1H5R0BB01#
				±0.25pF	GCQ1555C1H5R0CB01#
			5.1pF	±0.05pF	GCQ1555C1H5R1WB01#
				±0.1pF	GCQ1555C1H5R1BB01#
				±0.25pF	GCQ1555C1H5R1CB01#
				±0.5pF	GCQ1555C1H5R1DB01#
			5.2pF	±0.05pF	GCQ1555C1H5R2WB01#
				±0.1pF	GCQ1555C1H5R2BB01#
				±0.25pF	GCQ1555C1H5R2CB01#
				±0.5pF	GCQ1555C1H5R2DB01#
			5.3pF	±0.05pF	GCQ1555C1H5R3WB01#
				±0.1pF	GCQ1555C1H5R3BB01#
				±0.25pF	GCQ1555C1H5R3CB01#
				±0.5pF	GCQ1555C1H5R3DB01#
			5.4pF	±0.05pF	GCQ1555C1H5R4WB01#
				±0.1pF	GCQ1555C1H5R4BB01#
				±0.25pF	GCQ1555C1H5R4CB01#
				±0.5pF	GCQ1555C1H5R4DB01#
			5.5pF	±0.05pF	GCQ1555C1H5R5WB01#
				±0.1pF	GCQ1555C1H5R5BB01#
±0.25pF	GCQ1555C1H5R5CB01#				
±0.5pF	GCQ1555C1H5R5DB01#				

T max.	Rated Voltage	TC Code	Cap.	Tol.	Part Number
0.55mm	50Vdc	COG	5.5pF	±0.5pF	GCQ1555C1H5R5DB01#
				±0.05pF	GCQ1555C1H5R6WB01#
			5.6pF	±0.05pF	GCQ1555C1H5R6WB01#
				±0.1pF	GCQ1555C1H5R6BB01#
				±0.25pF	GCQ1555C1H5R6CB01#
				±0.5pF	GCQ1555C1H5R6DB01#
			5.7pF	±0.05pF	GCQ1555C1H5R7WB01#
				±0.1pF	GCQ1555C1H5R7BB01#
				±0.25pF	GCQ1555C1H5R7CB01#
				±0.5pF	GCQ1555C1H5R7DB01#
			5.8pF	±0.05pF	GCQ1555C1H5R8WB01#
				±0.1pF	GCQ1555C1H5R8BB01#
				±0.25pF	GCQ1555C1H5R8CB01#
				±0.5pF	GCQ1555C1H5R8DB01#
			5.9pF	±0.05pF	GCQ1555C1H5R9WB01#
				±0.1pF	GCQ1555C1H5R9BB01#
				±0.25pF	GCQ1555C1H5R9CB01#
				±0.5pF	GCQ1555C1H5R9DB01#
			6.0pF	±0.05pF	GCQ1555C1H6R0WB01#
				±0.1pF	GCQ1555C1H6R0BB01#
				±0.25pF	GCQ1555C1H6R0CB01#
				±0.5pF	GCQ1555C1H6R0DB01#
			6.1pF	±0.05pF	GCQ1555C1H6R1WB01#
				±0.1pF	GCQ1555C1H6R1BB01#
				±0.25pF	GCQ1555C1H6R1CB01#
				±0.5pF	GCQ1555C1H6R1DB01#
			6.2pF	±0.05pF	GCQ1555C1H6R2WB01#
				±0.1pF	GCQ1555C1H6R2BB01#
				±0.25pF	GCQ1555C1H6R2CB01#
				±0.5pF	GCQ1555C1H6R2DB01#
			6.3pF	±0.05pF	GCQ1555C1H6R3WB01#
				±0.1pF	GCQ1555C1H6R3BB01#
				±0.25pF	GCQ1555C1H6R3CB01#
				±0.5pF	GCQ1555C1H6R3DB01#
			6.4pF	±0.05pF	GCQ1555C1H6R4WB01#
				±0.1pF	GCQ1555C1H6R4BB01#
				±0.25pF	GCQ1555C1H6R4CB01#
				±0.5pF	GCQ1555C1H6R4DB01#
			6.5pF	±0.05pF	GCQ1555C1H6R5WB01#
				±0.1pF	GCQ1555C1H6R5BB01#
				±0.25pF	GCQ1555C1H6R5CB01#
				±0.5pF	GCQ1555C1H6R5DB01#
			6.6pF	±0.05pF	GCQ1555C1H6R6WB01#
				±0.1pF	GCQ1555C1H6R6BB01#
				±0.25pF	GCQ1555C1H6R6CB01#
				±0.5pF	GCQ1555C1H6R6DB01#
			6.7pF	±0.05pF	GCQ1555C1H6R7WB01#
				±0.1pF	GCQ1555C1H6R7BB01#
				±0.25pF	GCQ1555C1H6R7CB01#
				±0.5pF	GCQ1555C1H6R7DB01#
			6.8pF	±0.05pF	GCQ1555C1H6R8WB01#
				±0.1pF	GCQ1555C1H6R8BB01#
				±0.25pF	GCQ1555C1H6R8CB01#
				±0.5pF	GCQ1555C1H6R8DB01#
6.9pF	±0.05pF	GCQ1555C1H6R9WB01#			
	±0.5pF	GCQ1555C1H6R9DB01#			

GRT Series  
 GCM Series  
 GC3 Series  
 GCJ Series  
 GCQ Series  
 GCD Series  
 GCE Series  
 NMF Series  
 KCM Series  
 KC3 Series  
 KCA Series  
 GCG Series  
 ⚠Caution /Notice

Part number # indicates the package specification code.

# GCQ Series Temperature Compensating Type Part Number List

(→ 1.0×0.5mm)

T max.	Rated Voltage	TC Code	Cap.	Tol.	Part Number	T max.	Rated Voltage	TC Code	Cap.	Tol.	Part Number	
0.55mm	50Vdc	COG	6.9pF	±0.1pF	GCQ1555C1H6R9BB01#	0.55mm	50Vdc	COG	8.2pF	±0.5pF	GCQ1555C1H8R2DB01#	
				±0.25pF	GCQ1555C1H6R9CB01#					8.3pF	±0.05pF	GCQ1555C1H8R3WB01#
				±0.5pF	GCQ1555C1H6R9DB01#						±0.1pF	GCQ1555C1H8R3BB01#
			7.0pF	±0.05pF	GCQ1555C1H7R0WB01#				±0.25pF		GCQ1555C1H8R3CB01#	
				±0.1pF	GCQ1555C1H7R0BB01#				±0.5pF	GCQ1555C1H8R3DB01#		
				±0.25pF	GCQ1555C1H7R0CB01#				8.4pF	±0.05pF	GCQ1555C1H8R4WB01#	
			±0.5pF	GCQ1555C1H7R0DB01#	±0.1pF					GCQ1555C1H8R4BB01#		
			7.1pF	±0.05pF	GCQ1555C1H7R1WB01#					±0.25pF	GCQ1555C1H8R4CB01#	
				±0.1pF	GCQ1555C1H7R1BB01#				±0.5pF	GCQ1555C1H8R4DB01#		
				±0.25pF	GCQ1555C1H7R1CB01#				8.5pF	±0.05pF	GCQ1555C1H8R5WB01#	
			±0.5pF	GCQ1555C1H7R1DB01#	±0.1pF					GCQ1555C1H8R5BB01#		
			7.2pF	±0.05pF	GCQ1555C1H7R2WB01#					±0.25pF	GCQ1555C1H8R5CB01#	
				±0.1pF	GCQ1555C1H7R2BB01#				±0.5pF	GCQ1555C1H8R5DB01#		
				±0.25pF	GCQ1555C1H7R2CB01#				8.6pF	±0.05pF	GCQ1555C1H8R6WB01#	
			±0.5pF	GCQ1555C1H7R2DB01#	±0.1pF					GCQ1555C1H8R6BB01#		
			7.3pF	±0.05pF	GCQ1555C1H7R3WB01#					±0.25pF	GCQ1555C1H8R6CB01#	
				±0.1pF	GCQ1555C1H7R3BB01#				±0.5pF	GCQ1555C1H8R6DB01#		
				±0.25pF	GCQ1555C1H7R3CB01#				8.7pF	±0.05pF	GCQ1555C1H8R7WB01#	
			±0.5pF	GCQ1555C1H7R3DB01#	±0.1pF					GCQ1555C1H8R7BB01#		
			7.4pF	±0.05pF	GCQ1555C1H7R4WB01#					±0.25pF	GCQ1555C1H8R7CB01#	
				±0.1pF	GCQ1555C1H7R4BB01#				±0.5pF	GCQ1555C1H8R7DB01#		
				±0.25pF	GCQ1555C1H7R4CB01#				8.8pF	±0.05pF	GCQ1555C1H8R8WB01#	
			±0.5pF	GCQ1555C1H7R4DB01#	±0.1pF					GCQ1555C1H8R8BB01#		
			7.5pF	±0.05pF	GCQ1555C1H7R5WB01#					±0.25pF	GCQ1555C1H8R8CB01#	
				±0.1pF	GCQ1555C1H7R5BB01#				±0.5pF	GCQ1555C1H8R8DB01#		
				±0.25pF	GCQ1555C1H7R5CB01#				8.9pF	±0.05pF	GCQ1555C1H8R9WB01#	
			±0.5pF	GCQ1555C1H7R5DB01#	±0.1pF					GCQ1555C1H8R9BB01#		
			7.6pF	±0.05pF	GCQ1555C1H7R6WB01#					±0.25pF	GCQ1555C1H8R9CB01#	
				±0.1pF	GCQ1555C1H7R6BB01#				±0.5pF	GCQ1555C1H8R9DB01#		
				±0.25pF	GCQ1555C1H7R6CB01#				9.0pF	±0.05pF	GCQ1555C1H9R0WB01#	
			±0.5pF	GCQ1555C1H7R6DB01#	±0.1pF					GCQ1555C1H9R0BB01#		
			7.7pF	±0.05pF	GCQ1555C1H7R7WB01#					±0.25pF	GCQ1555C1H9R0CB01#	
				±0.1pF	GCQ1555C1H7R7BB01#				±0.5pF	GCQ1555C1H9R0DB01#		
				±0.25pF	GCQ1555C1H7R7CB01#				9.1pF	±0.05pF	GCQ1555C1H9R1WB01#	
			±0.5pF	GCQ1555C1H7R7DB01#	±0.1pF					GCQ1555C1H9R1BB01#		
			7.8pF	±0.05pF	GCQ1555C1H7R8WB01#					±0.25pF	GCQ1555C1H9R1CB01#	
				±0.1pF	GCQ1555C1H7R8BB01#				±0.5pF	GCQ1555C1H9R1DB01#		
				±0.25pF	GCQ1555C1H7R8CB01#				9.2pF	±0.05pF	GCQ1555C1H9R2WB01#	
			±0.5pF	GCQ1555C1H7R8DB01#	±0.1pF					GCQ1555C1H9R2BB01#		
			7.9pF	±0.05pF	GCQ1555C1H7R9WB01#					±0.25pF	GCQ1555C1H9R2CB01#	
				±0.1pF	GCQ1555C1H7R9BB01#				±0.5pF	GCQ1555C1H9R2DB01#		
				±0.25pF	GCQ1555C1H7R9CB01#				9.3pF	±0.05pF	GCQ1555C1H9R3WB01#	
			±0.5pF	GCQ1555C1H7R9DB01#	±0.1pF					GCQ1555C1H9R3BB01#		
			8.0pF	±0.05pF	GCQ1555C1H8R0WB01#					±0.25pF	GCQ1555C1H9R3CB01#	
				±0.1pF	GCQ1555C1H8R0BB01#				±0.5pF	GCQ1555C1H9R3DB01#		
				±0.25pF	GCQ1555C1H8R0CB01#				9.4pF	±0.05pF	GCQ1555C1H9R4WB01#	
			±0.5pF	GCQ1555C1H8R0DB01#	±0.1pF					GCQ1555C1H9R4BB01#		
			8.1pF	±0.05pF	GCQ1555C1H8R1WB01#					±0.25pF	GCQ1555C1H9R4CB01#	
±0.1pF	GCQ1555C1H8R1BB01#	±0.5pF		GCQ1555C1H9R4DB01#								
±0.25pF	GCQ1555C1H8R1CB01#	9.5pF		±0.05pF	GCQ1555C1H9R5WB01#							
±0.5pF	GCQ1555C1H8R1DB01#		±0.1pF	GCQ1555C1H9R5BB01#								
8.2pF	±0.05pF		GCQ1555C1H8R2WB01#	±0.25pF	GCQ1555C1H9R5CB01#							
	±0.1pF	GCQ1555C1H8R2BB01#	±0.5pF	GCQ1555C1H9R5DB01#								
	±0.25pF	GCQ1555C1H8R2CB01#	9.6pF	±0.05pF	GCQ1555C1H9R6WB01#							

Part number # indicates the package specification code.

GRT Series  
 GCM Series  
 GC3 Series  
 GCJ Series  
 GCQ Series  
 GCD Series  
 GCE Series  
 NMF Series  
 KCM Series  
 KC3 Series  
 KCA Series  
 GCG Series  
 Caution/ Notice



# GCQ Series Temperature Compensating Type Part Number List

(→ 1.0×0.5mm)

T max.	Rated Voltage	TC Code	Cap.	Tol.	Part Number
0.55mm	50Vdc	COG	9.6pF	±0.1pF	GCQ1555C1H9R6BB01#
				±0.25pF	GCQ1555C1H9R6CB01#
				±0.5pF	GCQ1555C1H9R6DB01#
			9.7pF	±0.05pF	GCQ1555C1H9R7WB01#
				±0.1pF	GCQ1555C1H9R7BB01#
				±0.25pF	GCQ1555C1H9R7CB01#
			9.8pF	±0.05pF	GCQ1555C1H9R8WB01#
				±0.1pF	GCQ1555C1H9R8BB01#
				±0.25pF	GCQ1555C1H9R8CB01#
			9.9pF	±0.05pF	GCQ1555C1H9R9WB01#
				±0.1pF	GCQ1555C1H9R9BB01#
				±0.25pF	GCQ1555C1H9R9CB01#
			10pF	±2%	GCQ1555C1H100GB01#
				±5%	GCQ1555C1H100JB01#
			11pF	±2%	GCQ1555C1H110GB01#
				±5%	GCQ1555C1H110JB01#
			12pF	±2%	GCQ1555C1H120GB01#
				±5%	GCQ1555C1H120JB01#
			13pF	±2%	GCQ1555C1H130GB01#
				±5%	GCQ1555C1H130JB01#
			15pF	±2%	GCQ1555C1H150GB01#
				±5%	GCQ1555C1H150JB01#
			16pF	±2%	GCQ1555C1H160GB01#
				±5%	GCQ1555C1H160JB01#
			18pF	±2%	GCQ1555C1H180GB01#
				±5%	GCQ1555C1H180JB01#
			20pF	±2%	GCQ1555C1H200GB01#
				±5%	GCQ1555C1H200JB01#
			22pF	±1%	GCQ1555C1H220FB01#
				±2%	GCQ1555C1H220GB01#
				±5%	GCQ1555C1H220JB01#
			24pF	±1%	GCQ1555C1H240FB01#
				±2%	GCQ1555C1H240GB01#
				±5%	GCQ1555C1H240JB01#
			27pF	±1%	GCQ1555C1H270FB01#
				±2%	GCQ1555C1H270GB01#
				±5%	GCQ1555C1H270JB01#
			30pF	±1%	GCQ1555C1H300FB01#
				±2%	GCQ1555C1H300GB01#
				±5%	GCQ1555C1H300JB01#
			33pF	±1%	GCQ1555C1H330FB01#
				±2%	GCQ1555C1H330GB01#
				±5%	GCQ1555C1H330JB01#
			36pF	±1%	GCQ1555C1H360FB01#
				±2%	GCQ1555C1H360GB01#
				±5%	GCQ1555C1H360JB01#
			39pF	±1%	GCQ1555C1H390FB01#
				±2%	GCQ1555C1H390GB01#
				±5%	GCQ1555C1H390JB01#
			43pF	±1%	GCQ1555C1H430FB01#
				±2%	GCQ1555C1H430GB01#

T max.	Rated Voltage	TC Code	Cap.	Tol.	Part Number
0.55mm	50Vdc	COG	43pF	±5%	GCQ1555C1H430JB01#
				±1%	GCQ1555C1H470FB01#
			47pF	±2%	GCQ1555C1H470GB01#
				±5%	GCQ1555C1H470JB01#

GRT Series  
 GCM Series  
 GC3 Series  
 GCJ Series  
 GCQ Series  
 GCD Series  
 GCE Series  
 NMF Series  
 KCM Series  
 KC3 Series  
 KCA Series  
 GCG Series  
 ⚠Caution / Notice

Part number # indicates the package specification code.

GRT Series  
 GCM Series  
 GC3 Series  
 GCJ Series  
 GCQ Series  
 GCD Series  
 GCE Series  
 NMF Series  
 KCM Series  
 KC3 Series  
 KCA Series  
 GCG Series  
 ⚠Caution/  
 Notice

MLSC Design Chip Multilayer Ceramic Capacitors for Automotive

**GCD Series**



**Prevents momentary dielectric breakdown by a 2-element array structure!**

Features

① Prevents momentary dielectric breakdown by a 2-element array structure!

This product consists of 2 elements arranged in 1 capacitor. It is structured so that even when 1 element is shorted, the other capacitor element will not short.

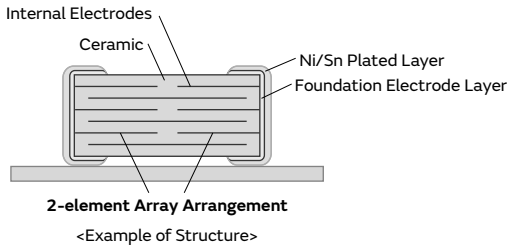

② This AEC-Q200 conforming product is ideal for the battery lines of automotive.

Space can be reduced in battery lines where 2 capacitors are arranged in an array.

Specifications

Size	1.6×0.8mm to 2.0×1.25mm
Rated Voltage	16Vdc to 100Vdc
Capacitance	1000pF to 0.50μF
Main Applications	Battery Lines and Powertrains for automotive

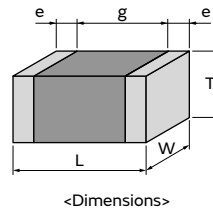

# GCD Series High Dielectric Constant Type Power-train AEC-Q200 Fail safe Deflecting crack Part Number List

## 1.6×0.8mm

T max.	Rated Voltage	TC Code	Cap.	Tol.	Part Number
0.9mm	100Vdc	X7R	1000pF	±10%	GCD188R72A102KA01#
			1200pF	±10%	GCD188R72A122KA01#
			1500pF	±10%	GCD188R72A152KA01#
			1800pF	±10%	GCD188R72A182KA01#
			2200pF	±10%	GCD188R72A222KA01#
			2700pF	±10%	GCD188R72A272KA01#
			3300pF	±10%	GCD188R72A332KA01#
			3900pF	±10%	GCD188R72A392KA01#
			4700pF	±10%	GCD188R72A472KA01#
			5600pF	±10%	GCD188R72A562KA01#
			6800pF	±10%	GCD188R72A682KA01#
			8200pF	±10%	GCD188R72A822KA01#
			10000pF	±10%	GCD188R72A103KA01#
			12000pF	±10%	GCD188R72A123KA01#
			15000pF	±10%	GCD188R72A153KA01#
			18000pF	±10%	GCD188R72A183KA01#
			22000pF	±10%	GCD188R72A223KA01#
			50Vdc	X7R	1000pF
	1200pF	±10%			GCD188R71H122KA01#
	1500pF	±10%			GCD188R71H152KA01#
	1800pF	±10%			GCD188R71H182KA01#
	2200pF	±10%			GCD188R71H222KA01#
	2700pF	±10%			GCD188R71H272KA01#
	3300pF	±10%			GCD188R71H332KA01#
3900pF	±10%	GCD188R71H392KA01#			
4700pF	±10%	GCD188R71H472KA01#			
5600pF	±10%	GCD188R71H562KA01#			
6800pF	±10%	GCD188R71H682KA01#			
8200pF	±10%	GCD188R71H822KA01#			
25Vdc	X7R	27000pF	±10%	GCD188R71E273KA01#	
		33000pF	±10%	GCD188R71E333KA01#	
		39000pF	±10%	GCD188R71E393KA01#	
		47000pF	±10%	GCD188R71E473KA01#	

## 2.0×1.25mm

T max.	Rated Voltage	TC Code	Cap.	Tol.	Part Number		
1.4mm	100Vdc	X7R	27000pF	±10%	GCD21BR72A273KA01#		
			33000pF	±10%	GCD21BR72A333KA01#		
			39000pF	±10%	GCD21BR72A393KA01#		
			47000pF	±10%	GCD21BR72A473KA01#		
			56000pF	±10%	GCD21BR72A563KA01#		
			68000pF	±10%	GCD21BR72A683KA01#		
			82000pF	±10%	GCD21BR72A823KA01#		
			0.10μF	±10%	GCD21BR72A104KA01#		
			50Vdc	X7R	27000pF	±10%	GCD21BR71H273KA01#

T max.	Rated Voltage	TC Code	Cap.	Tol.	Part Number
1.4mm	50Vdc	X7R	33000pF	±10%	GCD21BR71H333KA01#
			39000pF	±10%	GCD21BR71H393KA01#
			47000pF	±10%	GCD21BR71H473KA01#
			56000pF	±10%	GCD21BR71H563KA01#
			68000pF	±10%	GCD21BR71H683KA01#
			82000pF	±10%	GCD21BR71H823KA01#
			0.10μF	±10%	GCD21BR71H104KA01#
16Vdc	X7S	0.47μF	±10%	GCD21BC71C474KE01#	

Part number # indicates the package specification code.

GRT Series  
 GCM Series  
 GC3 Series  
 GCJ Series  
 GCQ Series  
 GCD Series  
 GCE Series  
 NMF Series  
 KCM Series  
 KC3 Series  
 KCA Series  
 GCG Series  
 Caution/Notice

Soft Termination MLSC Design Chip Multilayer Ceramic Capacitors for Automotive

**GCE Series**      

**Further improved safety performance with a combination of a 2-element array structure & resin external electrodes!**

Features

① **Avoid instantaneous dielectric breakdown with the 2-element array structure**

This product is configured with 2 elements arranged in one capacitor. Even if one element short circuits, the other element in the capacitor does not short.

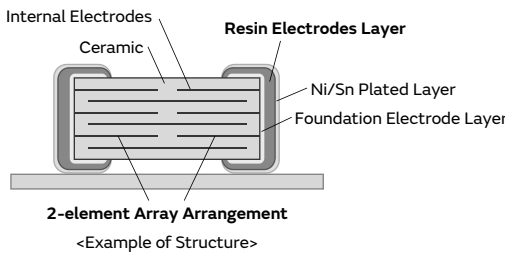

② **Provides additional safety performance in combination with resin electrodes**

Adopting resin electrodes as the external electrodes will suppress the occurrence of cracking in the capacitor by mechanical stress.

● **For Automotive (GCM Series)**

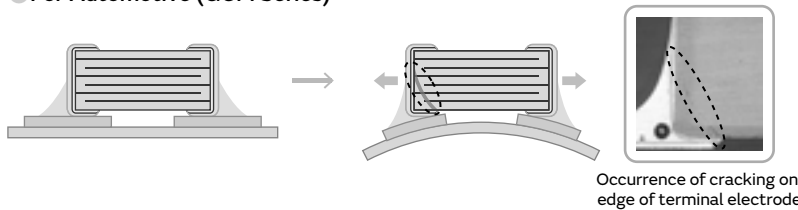

● **Fail Safe Design (GCE Series)**

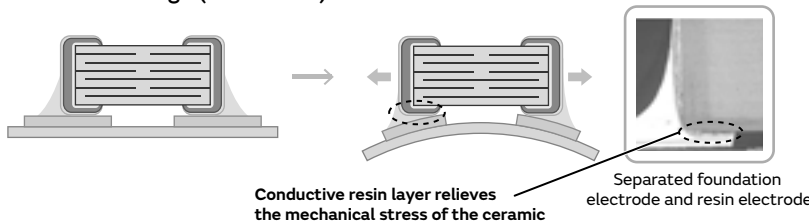

Note: Cracks may occur in the capacitor body if excessive stress beyond the "guaranteed range of board bending strength (\*)" provided in the specifications is applied. Capacitors with cracks in them may cause a drop in insulation resistance, which could lead to a short circuit.  
 (\*) For details on the guaranteed range of board bending strength, check the "Detailed Specification Sheet" on the Product Details Page.

③ **Ideal for battery lines of on-board applications**

Space can be reduced for battery lines, when 2 capacitors are configured in an array.

Specifications

Size	1.6×0.8mm to 2.0×1.25mm
Rated Voltage	25Vdc to 100Vdc
Capacitance	220pF to 0.10μF
Main Applications	For automotive, Battery lines, power trains

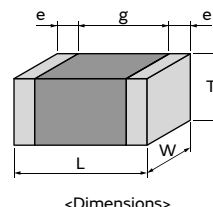

# GCE Series High Dielectric Constant Type Part Number List

## 1.6×0.8mm

T max.	Rated Voltage	TC Code	Cap.	Tol.	Part Number		
0.9mm	100Vdc	X7R	1000pF	±10%	GCE188R72A102KA01#		
			1200pF	±10%	GCE188R72A122KA01#		
			1500pF	±10%	GCE188R72A152KA01#		
			1800pF	±10%	GCE188R72A182KA01#		
			2200pF	±10%	GCE188R72A222KA01#		
			2700pF	±10%	GCE188R72A272KA01#		
			3300pF	±10%	GCE188R72A332KA01#		
			3900pF	±10%	GCE188R72A392KA01#		
			4700pF	±10%	GCE188R72A472KA01#		
			5600pF	±10%	GCE188R72A562KA01#		
			6800pF	±10%	GCE188R72A682KA01#		
			8200pF	±10%	GCE188R72A822KA01#		
			10000pF	±10%	GCE188R72A103KA01#		
			12000pF	±10%	GCE188R72A123KA01#		
			15000pF	±10%	GCE188R72A153KA01#		
			18000pF	±10%	GCE188R72A183KA01#		
			22000pF	±10%	GCE188R72A223KA01#		
			50Vdc	X7R	1000pF	±10%	GCE188R71H102KA01#
					1200pF	±10%	GCE188R71H122KA01#
					1500pF	±10%	GCE188R71H152KA01#
	1800pF	±10%			GCE188R71H182KA01#		
	2200pF	±10%			GCE188R71H222KA01#		
	2700pF	±10%			GCE188R71H272KA01#		
	3300pF	±10%			GCE188R71H332KA01#		
	3900pF	±10%			GCE188R71H392KA01#		
	4700pF	±10%			GCE188R71H472KA01#		
	5600pF	±10%			GCE188R71H562KA01#		
	6800pF	±10%			GCE188R71H682KA01#		
	8200pF	±10%			GCE188R71H822KA01#		
	10000pF	±10%			GCE188R71H103KA01#		
	12000pF	±10%			GCE188R71H123KA01#		
	15000pF	±10%			GCE188R71H153KA01#		
	18000pF	±10%			GCE188R71H183KA01#		
	22000pF	±10%	GCE188R71H223KA01#				
	25Vdc	X7R	27000pF	±10%	GCE188R71E273KA01#		
			33000pF	±10%	GCE188R71E333KA01#		
39000pF			±10%	GCE188R71E393KA01#			
47000pF			±10%	GCE188R71E473KA01#			

T max.	Rated Voltage	TC Code	Cap.	Tol.	Part Number
1.45mm	50Vdc	X7R	33000pF	±10%	GCE21BR71H333KA01#
			39000pF	±10%	GCE21BR71H393KA01#
			47000pF	±10%	GCE21BR71H473KA01#
			56000pF	±10%	GCE21BR71H563KA01#
			68000pF	±10%	GCE21BR71H683KA01#
			82000pF	±10%	GCE21BR71H823KA01#
			0.10μF	±10%	GCE21BR71H104KA01#

## 2.0×1.25mm

T max.	Rated Voltage	TC Code	Cap.	Tol.	Part Number		
1.45mm	100Vdc	X7R	27000pF	±10%	GCE21BR72A273KA01#		
			33000pF	±10%	GCE21BR72A333KA01#		
			39000pF	±10%	GCE21BR72A393KA01#		
			47000pF	±10%	GCE21BR72A473KA01#		
			56000pF	±10%	GCE21BR72A563KA01#		
			68000pF	±10%	GCE21BR72A683KA01#		
			82000pF	±10%	GCE21BR72A823KA01#		
			0.10μF	±10%	GCE21BR72A104KA01#		
			50Vdc	X7R	27000pF	±10%	GCE21BR71H273KA01#

Part number # indicates the package specification code.

GRT Series  
 GCM Series  
 GC3 Series  
 GCJ Series  
 GCQ Series  
 GCD Series  
 GCE Series  
 NMF Series  
 KCM Series  
 KC3 Series  
 KCA Series  
 GCG Series  
 ⚠Caution /Notice

GRT Series

GCM Series

GC3 Series

GCJ Series

GCQ Series

GCD Series

GCE Series

NMF Series

KCM Series

KC3 Series

KCA Series

GCG Series

⚠Caution/  
 Notice

3 Terminals Low ESL Chip Multilayer Ceramic Capacitors for Automotive

**NFM Series**      

This is the most suitable Low ESL capacitors for noise measurement and power decoupling of power train and safety equipment.

Features

① Low ESL

Since the equivalent series inductance (ESL) is low and excellent in high frequency characteristics, this capacitor is suitable for power supply decoupling of high-speed operation electronic equipment.

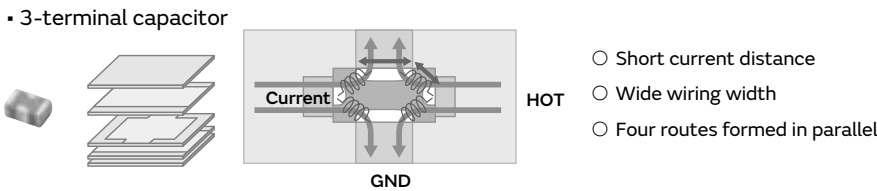
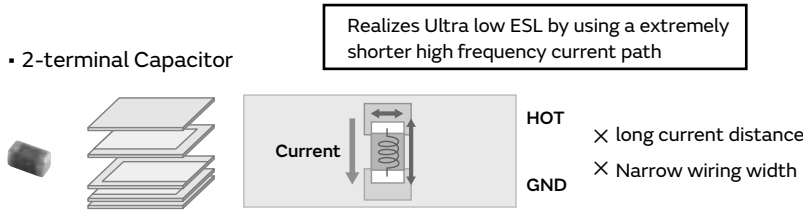

② Contributes to a reduction in the number of components.

The number of components can be reduced by using low ESL capacitors, while maintaining functions equivalent to 2-terminal capacitor.

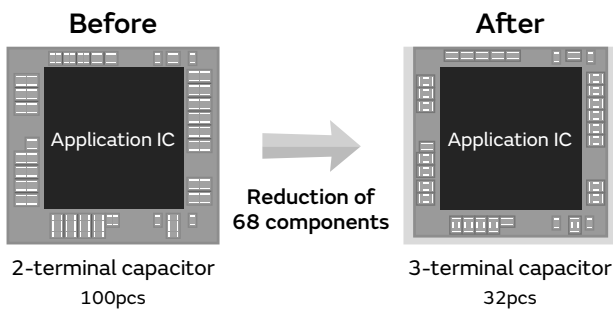

③ Contributes to noise suppression

Example of noise suppression effect 

④ Compliance with AEC-Q200

Use of 3-terminal low-ESL chip multilayer ceramic capacitors to decouple processor power supplies has recently surged in the automotive market due to demand for high performance processors and smaller electronics. This has accompanied the increase in high-functioning multitasking onboard equipment such as advanced driver assistance systems (ADAS), preventative safety systems for automated vehicles, and in-vehicle infotainment (IVI) systems.

## Specifications

Size	1.6×0.8mm to 3.2×1.6mm
Rated Voltage	6.3Vdc to 100Vdc
Capacitance	220pF to 1.0μF
Main Applications	Safety equipment, Drive system control, Information and Comfort equipment

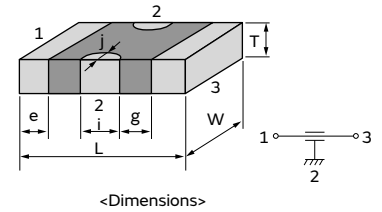

GRT Series

GCM Series

GC3 Series

GCJ Series

GCQ Series

GCD Series

GCE Series

NMF Series

KCM Series

KC3 Series

KCA Series

GCG Series

⚠Caution /Notice

01

**NFM Series**     **Part Number List**

**1.6×0.8mm**

T max.	Rated Voltage	Cap.	Tol.	Part Number	
0.7mm	16Vdc	1.0μF	±20%	<b>NFM18HC105C1C3#</b>	
	6.3Vdc	1.0μF	±20%	<b>NFM18HC105C0J3#</b>	

**2.0×1.25mm**

T max.	Rated Voltage	Cap.	Tol.	Part Number		
0.95mm	50Vdc	220pF	±20%	<b>NFM21HC221R1H3#</b>		
		470pF	±20%	<b>NFM21HC471R1H3#</b>		
		1000pF	±20%	<b>NFM21HC102R1H3#</b>		
		2200pF	±20%	<b>NFM21HC222R1H3#</b>		
		22000pF	±20%	<b>NFM21HC223R1H3#</b>		
	16Vdc	1.0μF	±20%	<b>NFM21HC105R1C3#</b>		
		10Vdc	0.10μF	±20%	<b>NFM21HC104R1A3#</b>	
			0.22μF	±20%	<b>NFM21HC224R1A3#</b>	
			0.47μF	±20%	<b>NFM21HC474R1A3#</b>	

**3.2×1.6mm**

T max.	Rated Voltage	Cap.	Tol.	Part Number	
1.5mm	100Vdc	10000pF	±20%	<b>NFM31HK103R2A3#</b>	<b>D3</b>
	50Vdc	10000pF	±20%	<b>NFM31HK103R1H3#</b>	<b>D3</b>
		15000pF	±20%	<b>NFM31HK153R1H3#</b>	<b>D3</b>
		22000pF	±20%	<b>NFM31HK223R1H3#</b>	<b>D3</b>
		0.10μF	±20%	<b>NFM31HK104R1H3#</b>	

GRT Series  
 GCM Series  
 GC3 Series  
 GCJ Series  
 GCQ Series  
 GCD Series  
 GCE Series  
 NMF Series  
 KCM Series  
 KC3 Series  
 KCA Series  
 GCG Series  
 △Caution/  
 Notice



Metal Terminal Type Multilayer Ceramic Capacitors for Automotive

KCM Series



**Bonding the metal terminals to external electrodes solves design issues by mounting large size MLCC!**

Features

① **Bond metal terminals to the external electrodes of chips.**

The stress applied to the chip is relieved by the elastic action of the metal terminal.

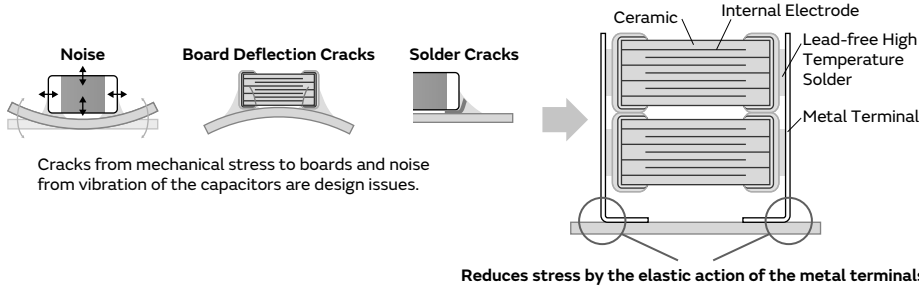

② **Substantially reduces noise, board deflection cracks and soldering cracks.**

This product is not damaged even with a board deflection of 6 mm.  
 Solder cracks do not occur even with 2,000 cycles of heat stress.

● **Comparison of Noise Reduction Effects**

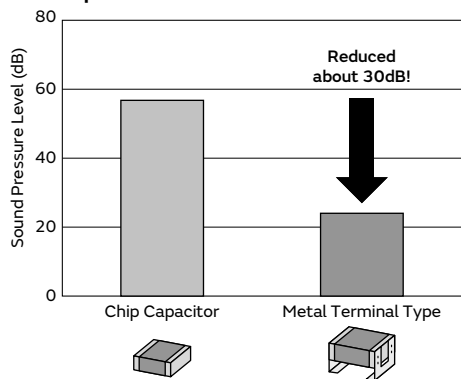

Evaluation Items: 5750 (in mm)/2220 (in inch) size/DC630V/220nF  
 Test Method: DC50V, AC10Vp-p/3kHz  
 Test Board: Glass Epoxy Board (T=1.6mm)  
 Test Quantity: 3pc  
 Distance Between Microphone and Board: 5mm

Note: Results Using Murata's Evaluation Board

● **Reduces Stress Caused by Board Deflection**

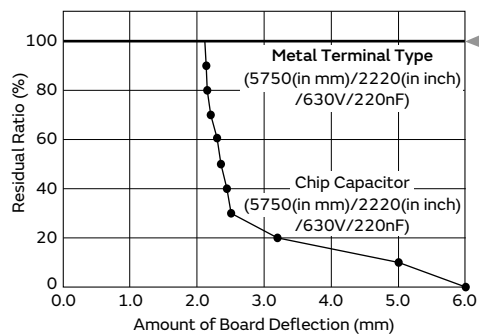

No damage, even with 6 mm board deflection!!

● **Suppresses Solder Cracks Caused by Heat Stress**

Chip Size	Chip Only (5750 (in mm)/2220 (in inch) size)		Metal Terminal Type (5750 (in mm)/2220 (in inch) size)	
1000 Cycles				
2000 Cycles				

Compared with chips only, this product is excellent in solder cracking resistance.

Test Condition: -55 to +125°C, 5min., (Liquid Phase)  
 Board Used: Glass Epoxy Board (FR-4)

GRT Series

GCM Series

GC3 Series

GCJ Series

GCQ Series

GCD Series

GCE Series

NMF Series

KCM Series

KC3 Series

KCA Series

GCG Series

⚠Caution/  
 Notice

③ **2 chips can be stacked.**

Realize large capacity by stacking 2 capacitors.

Specifications

Size	6.1×5.1mm to 6.1×5.3mm
Rated Voltage	25Vdc to 630Vdc
Capacitance	0.015μF to 100μF
Main Applications	For drive system control of engine ECU For other drive system controls and safety devices

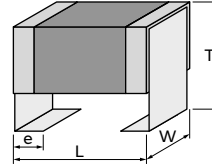

<Dimensions>

# KCM Series Temperature Compensating Type Part Number List

## 6.1×5.1mm

T max.	Rated Voltage	TC Code	Cap.	Tol.	Part Number	
3.1mm	630Vdc	COG	0.015μF	±5%	KCM55L5C2J153JDL1#	
			0.018μF	±5%	KCM55L5C2J183JDL1#	
3.9mm	630Vdc	COG	0.022μF	±5%	KCM55R5C2J223JDL1#	
			0.027μF	±5%	KCM55R5C2J273JDL1#	
5.1mm	630Vdc	COG	0.030μF	±5%	KCM55T5C2J303JDL1#	
			0.036μF	±5%	KCM55T5C2J363JDL1#	
6.6mm	630Vdc	COG	0.044μF	±5%	KCM55V5C2J443JDL2#	
			0.054μF	±5%	KCM55V5C2J543JDL2#	

GRT Series

GCM Series

GC3 Series

GCJ Series

GCQ Series

GCD Series

GCE Series

NMF Series

KCM Series

KC3 Series

KCA Series

GCG Series

△Caution /Notice

Part number # indicates the package specification code.

# KCM Series High Dielectric Constant Type Power-train AEC-Q200 Anti-noise Deflecting crack Soldering crack Part Number List

## 6.1×5.3mm

T max.	Rated Voltage	TC Code	Cap.	Tol.	Part Number
3.0mm	100Vdc	X7R	4.7μF	±10%	KCM55LR72A475KH01#
	63Vdc	X7R	4.7μF	±10%	KCM55LR71J475KH01#
	50Vdc	X7R	4.7μF	±10%	KCM55LR71H475KH01#
			10μF	±10%	KCM55LR71H106KH01#
	35Vdc	X7R	10μF	±10%	KCM55LR7YA106KH01#
			15μF	±10%	KCM55LR7YA156KH01#
25Vdc	X7R	15μF	±10%	KCM55LR71E156KH01#	
3.9mm	100Vdc	X7R	6.8μF	±10%	KCM55QR72A685KH01#
			10μF	±10%	KCM55QR72A106KH01#
	63Vdc	X7R	10μF	±10%	KCM55QR71J106KH01#
	50Vdc	X7R	17μF	±10%	KCM55QR71H176KH01#
	35Vdc	X7R	17μF	±10%	KCM55QR7YA176KH01#
			22μF	±10%	KCM55QR7YA226KH01#
	25Vdc	X7R	22μF	±10%	KCM55QR71E226KH01#
			33μF	±10%	KCM55QR71E336KH01#
X7S			47μF	±10%	KCM55QC71E476KH13#
5.0mm	50Vdc	X7R	22μF	±20%	KCM55TR71H226MH01#
	35Vdc	X7R	33μF	±20%	KCM55TR7YA336MH01#
6.7mm	100Vdc	X7R	15μF	±20%	KCM55WR72A156MH01#
			22μF	±20%	KCM55WR72A226MH01#
	63Vdc	X7R	22μF	±20%	KCM55WR71J226MH01#
	50Vdc	X7R	33μF	±20%	KCM55WR71H336MH01#
	35Vdc	X7R	47μF	±20%	KCM55WR7YA476MH01#
	25Vdc	X7R	47μF	±20%	KCM55WR71E476MH01#
			68μF	±20%	KCM55WR71E686MH01#
X7S	100μF	±20%	KCM55WC71E107MH13#		

GRT Series  
 GCM Series  
 GC3 Series  
 GCJ Series  
 GCQ Series  
 GCD Series  
 GCE Series  
 NMF Series  
 KCM Series  
 KC3 Series  
 KCA Series  
 GCG Series  
 △Caution/ Notice

High Effective Capacitance & High Allowable Ripple Current Metal Terminal Type Multilayer Ceramic Capacitors for Automotive

# KC3 Series



**Bonding the metal terminals to external electrodes solves design issues by mounting large size MLCC!**

## Features

### 1 Bond Metal Terminals to External Electrodes of Chips

This product has high resistance to heat and mechanical impact and greatly reduces acoustic noise of boards by ceramics.

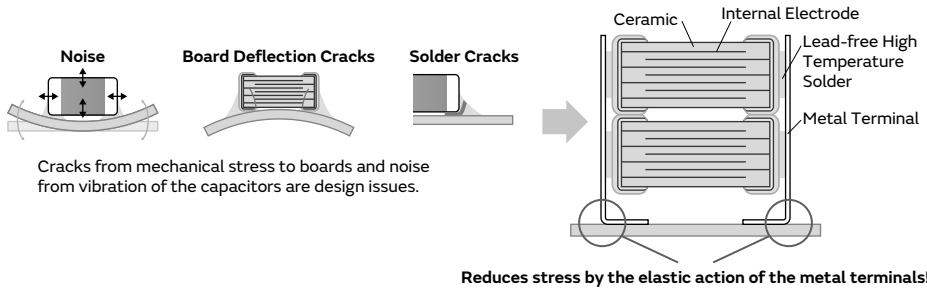

### 2 Stacking of Chips

Achieve high capacity by stacking 2 capacitors.

#### Comparison of Noise Reduction Effects

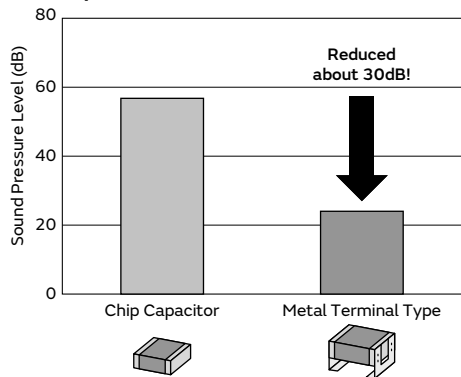

Evaluation Items: 5750 (in mm)/2220 (in inch) size/DC630V/220nF  
 Test Method: DC50V, AC10Vp-p/3kHz  
 Test Board: Glass Epoxy Board (T=1.6mm)  
 Test Quantity: 3pc  
 Distance Between Microphone and Board: 5mm

Note: Results Using Murata's Evaluation Board

#### Reduces Stress Caused by Board Deflection

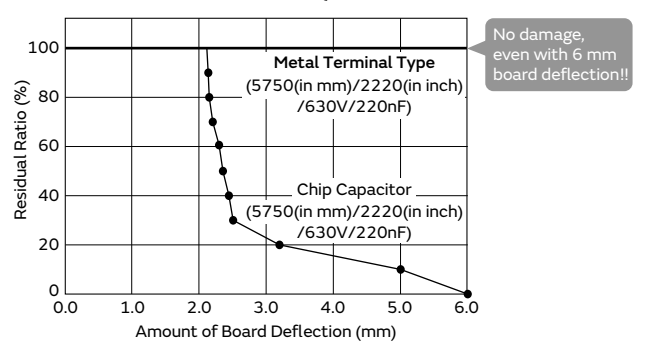

#### Suppresses Solder Cracks Caused by Heat Stress

Chip Size	Chip Only (5750 (in mm)/2220 (in inch) size)		Metal Terminal Type (5750 (in mm)/2220 (in inch) size)	
1000 Cycles				
2000 Cycles				

Compared with chips only, this product is excellent in solder cracking resistance.

Test Condition: -55 to +125°C, 5min., (Liquid Phase)  
 Board Used: Glass Epoxy Board (FR-4)

GRT Series  
 GCM Series  
 GC3 Series  
 GCJ Series  
 GCQ Series  
 GCD Series  
 GCE Series  
 NMF Series  
 KCM Series  
 KC3 Series  
 KCA Series  
 GCG Series  
 ⚠️Caution / Notice

GRT Series

GCM Series

GC3 Series

GCJ Series

GCQ Series

GCD Series

GCE Series

NMF Series

KCM Series

KC3 Series

KCA Series

GCG Series

⚠Caution/  
 Notice

### 3 Adopted Low Dielectric Constant Materials

Improved effective capacity and ripple resistant performance, compared to conventional products (X7R characteristics).

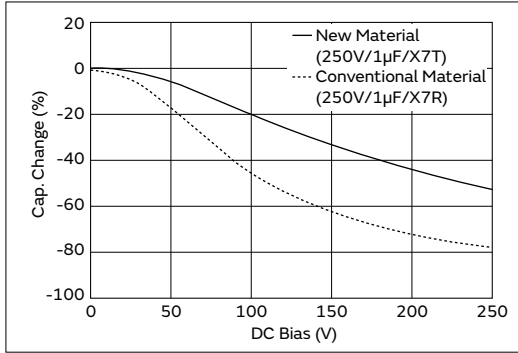

### 4 2 chips can be stacked

Realize large capacity by stacking 2 capacitors.

### Specifications

Size	6.1×5.3mm
Rated Voltage	250Vdc to 630Vdc
Capacitance	0.10µF to 2.2µF
Main Applications	For drive system control of engine ECU For other drive system controls and safety devices

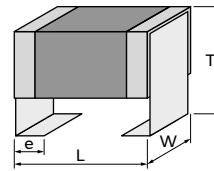

<Dimensions>

# KC3 Series High Dielectric Constant Type Part Number List

## 6.1×5.3mm

T max.	Rated Voltage	TC Code	Cap.	Tol.	Part Number	
3.0mm	630Vdc	X7T	0.10μF	±10%	KC355LD72J104KH01#	
			0.15μF	±10%	KC355LD72J154KH01#	
			0.33μF	±10%	KC355LD7LQ334KV01#	<b>D2</b>
			0.47μF	±10%	KC355LD7LQ474KV01#	<b>D2</b>
	450Vdc	X7T	0.22μF	±10%	KC355LD72W224KH01#	
			0.33μF	±10%	KC355LD72W334KH01#	
			0.47μF	±10%	KC355LD72W474KH01#	
			0.68μF	±10%	KC355LD7LP684KV01#	<b>D2</b>
	250Vdc	X7T	0.47μF	±10%	KC355LD72E474KH01#	
			0.68μF	±10%	KC355LD72E684KH01#	
3.9mm	630Vdc	X7T	0.22μF	±10%	KC355QD72J224KH01#	
			0.27μF	±10%	KC355QD72J274KH01#	
			0.56μF	±10%	KC355QD7LQ564KV01#	<b>D2</b>
	450Vdc	X7T	0.56μF	±10%	KC355QD72W564KH01#	
			1.0μF	±10%	KC355QD7LP105KV01#	<b>D2</b>
	250Vdc	X7T	1.0μF	±10%	KC355QD72E105KH01#	
5.0mm	630Vdc	X7T	0.68μF	±20%	KC355TD7LQ684MV01#	<b>D2</b>
			1.0μF	±20%	KC355TD7LQ105MV01#	<b>D2</b>
	450Vdc	X7T	0.68μF	±20%	KC355TD72W684MH01#	
			1.0μF	±20%	KC355TD72W105MH01#	
			1.5μF	±20%	KC355TD7LP155MV01#	<b>D2</b>
	250Vdc	X7T	1.5μF	±20%	KC355TD72E155MH01#	
6.7mm	630Vdc	X7T	0.47μF	±20%	KC355WD72J474MH01#	
			0.56μF	±20%	KC355WD72J564MH01#	
			1.2μF	±20%	KC355WD7LQ125MV01#	<b>D2</b>
	450Vdc	X7T	1.2μF	±20%	KC355WD72W125MH01#	
			2.2μF	±20%	KC355WD7LP225MV01#	<b>D2</b>
	250Vdc	X7T	2.2μF	±20%	KC355WD72E225MH01#	

GRT Series  
 GCM Series  
 GC3 Series  
 GCJ Series  
 GCQ Series  
 GCD Series  
 GCE Series  
 NMF Series  
 KCM Series  
 KC3 Series  
 KCA Series  
 GCG Series  
 ⚠Caution /Notice

Safety Standard Certified Metal Terminal Type Multilayer Ceramic Capacitors for Automotive

**KCA Series**



**For Automotive IEC60384-14 X1/Y2 Class Certified Product (Basic insulation product)**

**Features**

- 1 **IEC60384-14 certified product: Rated voltage AC250V (r.m.s.).**

Please download Safety Standard Certification (Type MF: X1,Y2) from Web site.

- 2 **Best suitable for class Y2 capacitors.**

AC250V (r.m.s.)-rated voltage, withstand voltage of AC2000V (r.m.s.) guaranteed for 60 seconds.

● **OBC (On Board Charger)**

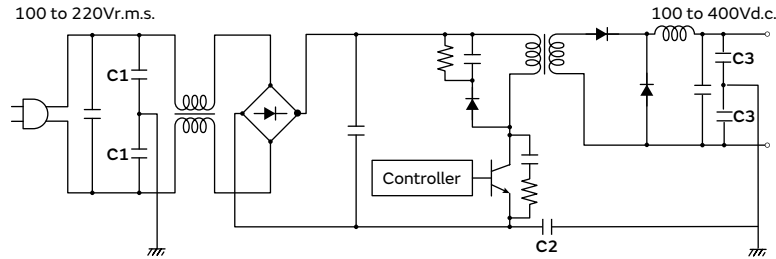

No.	Application
C1	Y Cap (Primary)
C2	Primary-Secondary Coupling
C3	Y Cap (Secondary)

- 3 **Best suitable for DC input common mode noise filters.**

DC630V-rated voltage, withstand voltage of DC2700V guaranteed for 60 seconds.

● **Inverter**

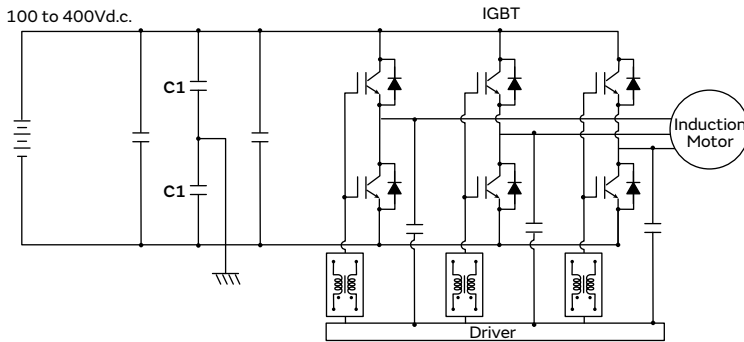

No.	Application
C1	Common mode noise filters

● **DC-DC Converter**

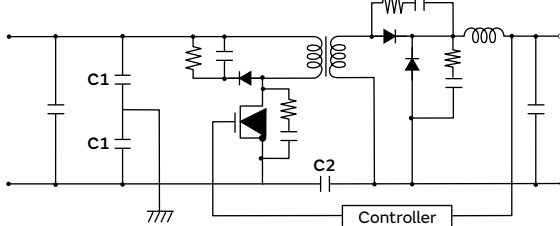

No.	Application
C1	Common mode noise filters
C2	Primary-Secondary Coupling



**4 Bond metal terminals to the external electrodes of chips.**

The stress applied to the chip is relieved by the elastic action of the metal terminal.

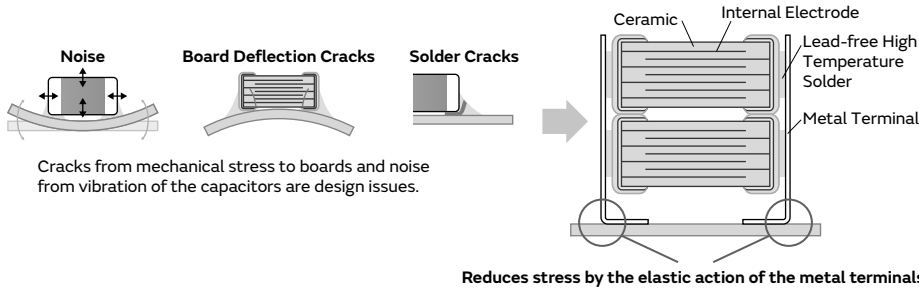

**5 Substantially reduces board deflection cracks and soldering cracks.**

This product is not damaged even with a board deflection of 6 mm. Solder cracks do not occur even with 2,000 cycles of heat stress.

● Reduces Stress Caused by Board Deflection

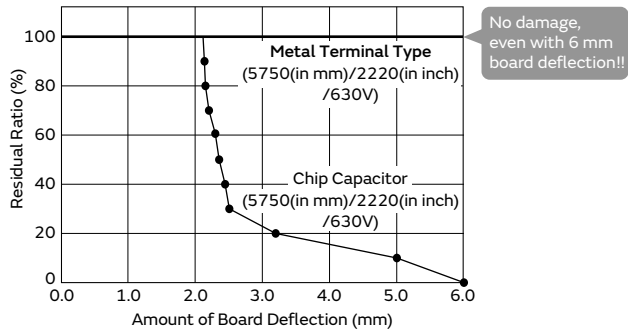

● Suppresses Solder Cracks Caused by Heat Stress

Chip Size	Chip Only (5750 (in mm)/2220 (in inch) size)	Metal Terminal Type (5750 (in mm)/2220 (in inch) size)
1000 Cycles	 ↑ Solder Crack	
2000 Cycles	 ↑ Solder Crack	 Compared with chips only, this product is excellent in solder cracking resistance.

Test Condition: -55 to +125°C, 5min., (Liquid Phase)  
 Board Used: Glass Epoxy Board (FR-4)

**6 2 chips can be stacked.**

Realize large capacity by stacking 2 capacitors.

**Specifications**

Size	6.1×5.1mm
Rated Voltage	250Vac (r.m.s.)
Capacitance	100pF to 10000pF
Main Applications	Battery chargers, Inverter, DC-DC converters

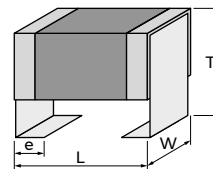

<Dimensions>

**KCA Series Temperature Compensating Type**       **Part Number List**

**6.1×5.1mm**

T max.	Rated Voltage	TC Code	Cap.	Tol.	Part Number
3.0mm	250Vac(r.m.s.)	U2J	100pF	±10%	KCA55L7UMF101KL01#
			150pF	±10%	KCA55L7UMF151KL01#
			220pF	±10%	KCA55L7UMF221KL01#
			330pF	±10%	KCA55L7UMF331KL01#
			470pF	±10%	KCA55L7UMF471KL01#
			680pF	±10%	KCA55L7UMF681KL01#
			1000pF	±10%	KCA55L7UMF102KL01#
			1500pF	±10%	KCA55L7UMF152KL01#
			2200pF	±10%	KCA55L7UMF222KL01#
			3300pF	±10%	KCA55L7UMF332KL01#
3.9mm	250Vac(r.m.s.)	U2J	4700pF	±10%	KCA55Q7UMF472KL01#
5.0mm	250Vac(r.m.s.)	U2J	6800pF	±20%	KCA55T7UMF682ML01#
6.7mm	250Vac(r.m.s.)	U2J	10000pF	±20%	KCA55W7UMF103ML01#

- GRT Series
- GCM Series
- GC3 Series
- GCJ Series
- GCQ Series
- GCD Series
- GCE Series
- NMF Series
- KCM Series
- KC3 Series
- KCA Series
- GCG Series
- ⚠Caution/Notice

AgPd Termination Conductive Glue Mounting Chip Multilayer Ceramic Capacitors for Automotive

**GCG Series**



**Improved mechanical and thermal strength by adopting AgPd external electrodes, which can be mounted with a conductive glue!**

**Features**

**① Limited to Conductive Glue Mounting**

This capacitor can be mounted with a conductive adhesive\* in powertrains and safety devices of automotive.

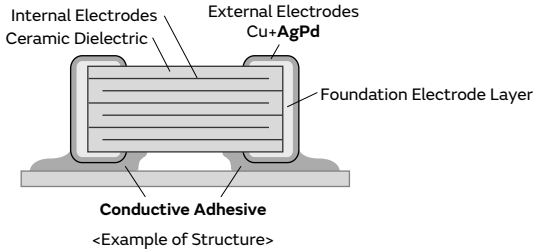

**② Adopted AgPd external electrodes**

Adopted AgPd, which is excellent in bonding strength with a conductive adhesive.

**③ Compatible up to 150°C**

This capacitor lineup with X8L and X8R characteristics can be used in high temperature environments, such as in ABS and transmission control.

\* This product is for use exclusively with conductive glue mounting. It cannot be used with any mounting methods other than conductive glue mounting.

Using solder to mount the product can result in insufficient wetting, insufficient bonding strength, and/or leaching of the Ag/Pd External Electrodes (terminations), which can cause quality problems such as the chip coming loose.

**Specifications**

Size	1.0×0.5mm to 3.2×2.5mm
Rated Voltage	6.3Vdc to 100Vdc
Capacitance	1.0pF to 47μF
Main Applications	For automotive, power trains, sensors

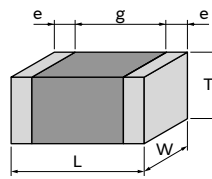

<Dimensions>

GRT Series  
 GCM Series  
 GC3 Series  
 GCJ Series  
 GCQ Series  
 GCD Series  
 GCE Series  
 NMF Series  
 KCM Series  
 KC3 Series  
 KCA Series  
 GCG Series  
 ⚠Caution /Notice

# GCG Series Temperature Compensating Type Part Number List

## 1.0×0.5mm

T max.	Rated Voltage	TC Code	Cap.	Tol.	Part Number
0.55mm	50Vdc	X8G	120pF	±5%	GCG1555G1H121JA01#
			150pF	±5%	GCG1555G1H151JA01#
			180pF	±5%	GCG1555G1H181JA01#
			220pF	±5%	GCG1555G1H221JA01#
			270pF	±5%	GCG1555G1H271JA01#
			330pF	±5%	GCG1555G1H331JA01#
			390pF	±5%	GCG1555G1H391JA01#
			470pF	±5%	GCG1555G1H471JA01#

## 1.6×0.8mm

T max.	Rated Voltage	TC Code	Cap.	Tol.	Part Number	
0.9mm	100Vdc	X8G	10pF	±5%	GCG1885G2A100JA01#	
			12pF	±5%	GCG1885G2A120JA01#	
			15pF	±5%	GCG1885G2A150JA01#	
			18pF	±5%	GCG1885G2A180JA01#	
			22pF	±5%	GCG1885G2A220JA01#	
			27pF	±5%	GCG1885G2A270JA01#	
			33pF	±5%	GCG1885G2A330JA01#	
			39pF	±5%	GCG1885G2A390JA01#	
			47pF	±5%	GCG1885G2A470JA01#	
			56pF	±5%	GCG1885G2A560JA01#	
			68pF	±5%	GCG1885G2A680JA01#	
			82pF	±5%	GCG1885G2A820JA01#	
			100pF	±5%	GCG1885G2A101JA01#	
			120pF	±5%	GCG1885G2A121JA01#	
			150pF	±5%	GCG1885G2A151JA01#	
			180pF	±5%	GCG1885G2A181JA01#	
			220pF	±5%	GCG1885G2A221JA01#	
			270pF	±5%	GCG1885G2A271JA01#	
			330pF	±5%	GCG1885G2A331JA01#	
			390pF	±5%	GCG1885G2A391JA01#	
			470pF	±5%	GCG1885G2A471JA01#	
			560pF	±5%	GCG1885G2A561JA01#	
			680pF	±5%	GCG1885G2A681JA01#	
			820pF	±5%	GCG1885G2A821JA01#	
			1000pF	±5%	GCG1885G2A102JA01#	
			U2J	1000pF	±5%	GCG1887U2A102JA01#
				1200pF	±5%	GCG1887U2A122JA01#
				1500pF	±5%	GCG1887U2A152JA01#
				1800pF	±5%	GCG1887U2A182JA01#
				2200pF	±5%	GCG1887U2A222JA01#
				2700pF	±5%	GCG1887U2A272JA01#
				3300pF	±5%	GCG1887U2A332JA01#
		3900pF		±5%	GCG1887U2A392JA01#	
		50Vdc	X8G	10pF	±5%	GCG1885G1H100JA01#

T max.	Rated Voltage	TC Code	Cap.	Tol.	Part Number
0.9mm	50Vdc	X8G	12pF	±5%	GCG1885G1H120JA01#
			15pF	±5%	GCG1885G1H150JA01#
			18pF	±5%	GCG1885G1H180JA01#
			22pF	±5%	GCG1885G1H220JA01#
			27pF	±5%	GCG1885G1H270JA01#
			33pF	±5%	GCG1885G1H330JA01#
			39pF	±5%	GCG1885G1H390JA01#
			47pF	±5%	GCG1885G1H470JA01#
			56pF	±5%	GCG1885G1H560JA01#
			68pF	±5%	GCG1885G1H680JA01#
			82pF	±5%	GCG1885G1H820JA01#
			100pF	±5%	GCG1885G1H101JA01#
			120pF	±5%	GCG1885G1H121JA01#
			150pF	±5%	GCG1885G1H151JA01#
			180pF	±5%	GCG1885G1H181JA01#
			220pF	±5%	GCG1885G1H221JA01#
			270pF	±5%	GCG1885G1H271JA01#
			330pF	±5%	GCG1885G1H331JA01#
			390pF	±5%	GCG1885G1H391JA01#
			470pF	±5%	GCG1885G1H471JA01#
			560pF	±5%	GCG1885G1H561JA01#
			680pF	±5%	GCG1885G1H681JA01#
			820pF	±5%	GCG1885G1H821JA01#
			1000pF	±5%	GCG1885G1H102JA01#
			1200pF	±5%	GCG1885G1H122JA01#
			1500pF	±5%	GCG1885G1H152JA01#
			1800pF	±5%	GCG1885G1H182JA01#
			2200pF	±5%	GCG1885G1H222JA01#

## 2.0×1.25mm

T max.	Rated Voltage	TC Code	Cap.	Tol.	Part Number			
0.7mm	50Vdc	X8G	1000pF	±5%	GCG2165G1H102JA01#			
			1200pF	±5%	GCG2165G1H122JA01#			
			1500pF	±5%	GCG2165G1H152JA01#			
			1800pF	±5%	GCG2165G1H182JA01#			
			2200pF	±5%	GCG2165G1H222JA01#			
			2700pF	±5%	GCG2165G1H272JA01#			
			3300pF	±5%	GCG2165G1H332JA01#			
			3900pF	±5%	GCG2165G1H392JA01#			
			4700pF	±5%	GCG2165G1H472JA01#			
			0.95mm	50Vdc	X8G	5600pF	±5%	GCG2195G1H562JA01#
						6800pF	±5%	GCG2195G1H682JA01#
						8200pF	±5%	GCG2195G1H822JA01#
						10000pF	±5%	GCG2195G1H103JA01#

Part number # indicates the package specification code.

GRT Series  
 GCM Series  
 GC3 Series  
 GCJ Series  
 GCQ Series  
 GCD Series  
 GCE Series  
 NMF Series  
 KCM Series  
 KC3 Series  
 KCA Series  
 GCG Series  
 ⚠Caution/ Notice

# GCG Series High Dielectric Constant Type Part Number List

## 1.0×0.5mm

T max.	Rated Voltage	TC Code	Cap.	Tol.	Part Number		
0.55mm	50Vdc	X8L	220pF	±10%	GCG155L81H221KA02#		
			330pF	±10%	GCG155L81H331KA02#		
			470pF	±10%	GCG155L81H471KA02#		
			680pF	±10%	GCG155L81H681KA02#		
			1000pF	±10%	GCG155L81H102KA02#		
			1500pF	±10%	GCG155L81H152KA02#		
			2200pF	±10%	GCG155L81H222KA02#		
			3300pF	±10%	GCG155L81H332KA02#		
			4700pF	±10%	GCG155L81H472KA02#		
		X7R	220pF	±10%	GCG155R71H221KA01#		
			270pF	±10%	GCG155R71H271KA01#		
			330pF	±10%	GCG155R71H331KA01#		
			390pF	±10%	GCG155R71H391KA01#		
			470pF	±10%	GCG155R71H471KA01#		
			560pF	±10%	GCG155R71H561KA01#		
			680pF	±10%	GCG155R71H681KA01#		
			820pF	±10%	GCG155R71H821KA01#		
			1000pF	±10%	GCG155R71H102KA01#		
			1200pF	±10%	GCG155R71H122KA01#		
	1500pF		±10%	GCG155R71H152KA01#			
	1800pF		±10%	GCG155R71H182KA01#			
	2200pF		±10%	GCG155R71H222KA01#			
	2700pF		±10%	GCG155R71H272KA01#			
	3300pF		±10%	GCG155R71H332KA01#			
	3900pF		±10%	GCG155R71H392KA01#			
	4700pF		±10%	GCG155R71H472KA01#			
	25Vdc		X8L	5600pF	±10%	GCG155L81E562KA01#	
		6800pF		±10%	GCG155L81E682KA01#		
		8200pF		±10%	GCG155L81E822KA01#		
		10000pF		±10%	GCG155L81E103KA01#		
		X7R	5600pF	±10%	GCG155R71E562KA01#		
			6800pF	±10%	GCG155R71E682KA01#		
			8200pF	±10%	GCG155R71E822KA01#		
			10000pF	±10%	GCG155R71E103KA01#		
			16Vdc	X8L	15000pF	±10%	GCG155L81C153KA01#
					18000pF	±10%	GCG155L81C183KA01#
	22000pF	±10%			GCG155L81C223KA01#		
	27000pF	±10%			GCG155L81C273KA01#		
	33000pF	±10%			GCG155L81C333KA01#		
	39000pF	±10%			GCG155L81C393KA01#		
	47000pF	±10%			GCG155L81C473KA01#		
	X7R	15000pF	±10%	GCG155R71C153KA01#			
		18000pF	±10%	GCG155R71C183KA01#			
		22000pF	±10%	GCG155R71C223KA01#			
		27000pF	±10%	GCG155R71C273KA01#			
		33000pF	±10%	GCG155R71C333KA01#			
		39000pF	±10%	GCG155R71C393KA01#			
47000pF		±10%	GCG155R71C473KA01#				
56000pF		±10%	GCG155R71C563KA01#				
68000pF		±10%	GCG155R71C683KA01#				
82000pF		±10%	GCG155R71C823KA01#				
0.10μF	±10%	GCG155R71C104KA01#					

## 1.6×0.8mm

T max.	Rated Voltage	TC Code	Cap.	Tol.	Part Number			
0.9mm	100Vdc	X8R	1000pF	±10%	GCG188R92A102KA01#			
			1200pF	±10%	GCG188R92A122KA01#			
			1500pF	±10%	GCG188R92A152KA01#			
			1800pF	±10%	GCG188R92A182KA01#			
			2200pF	±10%	GCG188R92A222KA01#			
			2700pF	±10%	GCG188R92A272KA01#			
			3300pF	±10%	GCG188R92A332KA01#			
			3900pF	±10%	GCG188R92A392KA01#			
			4700pF	±10%	GCG188R92A472KA01#			
			5600pF	±10%	GCG188R92A562KA01#			
			6800pF	±10%	GCG188R92A682KA01#			
			8200pF	±10%	GCG188R92A822KA01#			
			10000pF	±10%	GCG188R92A103KA01#			
			12000pF	±10%	GCG188R92A123KA01#			
			15000pF	±10%	GCG188R92A153KA01#			
			18000pF	±10%	GCG188R92A183KA01#			
			22000pF	±10%	GCG188R92A223KA01#			
			27000pF	±10%	GCG188R92A273KA01#			
			33000pF	±10%	GCG188R92A333KA01#			
			39000pF	±10%	GCG188R92A393KA01#			
			47000pF	±10%	GCG188R92A473KA01#			
			56000pF	±10%	GCG188R92A563KA01#			
			68000pF	±10%	GCG188R92A683KA01#			
			0.10μF	±10%	GCG188R92A104KA03#			
			50Vdc	X8L	0.15μF	±10%	GCG188L8EH154KA07#	<b>D4</b>
					0.22μF	±10%	GCG188L8EH224KA07#	<b>D4</b>
				X8R	1200pF	±10%	GCG188R91H122KA03#	
					1500pF	±10%	GCG188R91H152KA03#	
					2200pF	±10%	GCG188R91H222KA03#	
					2700pF	±10%	GCG188R91H272KA03#	
					3300pF	±10%	GCG188R91H332KA03#	
					3900pF	±10%	GCG188R91H392KA03#	
					4700pF	±10%	GCG188R91H472KA03#	
	5600pF	±10%			GCG188R91H562KA03#			
	6800pF	±10%			GCG188R91H682KA03#			
	8200pF	±10%			GCG188R91H822KA03#			
	10000pF	±10%			GCG188R91H103KA03#			
	15000pF	±10%			GCG188R91H153KA03#			
	22000pF	±10%	GCG188R91H223KA03#					
	33000pF	±10%	GCG188R91H333KA03#					
	47000pF	±10%	GCG188R91H473KA03#					
	0.10μF	±10%	GCG188R91H104KA01#					
	0.12μF	±10%	GCG188R91H124KA01#					
	0.15μF	±10%	GCG188R91H154KA01#					
	0.18μF	±10%	GCG188R91H184KA01#					
	0.22μF	±10%	GCG188R91H224KA01#					
	X7R	0.15μF	±10%	GCG188R71H154KA01#				
0.22μF		±10%	GCG188R71H224KA01#					
25Vdc		X8R	0.33μF	±10%	GCG188R91E334KA01#			
			0.39μF	±10%	GCG188R91E394KA01#			
			0.47μF	±10%	GCG188R91E474KA01#			
X7R	0.12μF	±10%	GCG188R71E124KA12#					

Part number # indicates the package specification code.

# GCG Series High Dielectric Constant Type Power-train AEC-Q200 Defecting crack Soldering crack Limited to conductive glue mounting Part Number List

(→ 1.6×0.8mm)

T max.	Rated Voltage	TC Code	Cap.	Tol.	Part Number		
0.9mm	25Vdc	X7R	0.15μF	±10%	GCG188R71E154KA12#		
			0.18μF	±10%	GCG188R71E184KA12#		
			0.22μF	±10%	GCG188R71E224KA12#		
	16Vdc	X8L	0.15μF	±10%	GCG188L81C154KA01#		
			0.22μF	±10%	GCG188L81C224KA01#		
			1.0μF	±10%	GCG188L8EE105KA07#	<b>D4</b>	
			X7R	1.0μF	±10%	GCG188R71C105KA01#	
	10Vdc	X7S	2.2μF	±10%	GCG188C71A225KE01#		
	6.3Vdc	X7R	2.2μF	±10%	GCG188R70J225KE01#		

2.0×1.25mm

T max.	Rated Voltage	TC Code	Cap.	Tol.	Part Number	
1.45mm	50Vdc	X8L	1.0μF	±10%	GCG21BL8EH105KA07#	<b>D4</b>
			X7R	0.15μF	±10%	GCG21BR71H154KA01#
			0.18μF	±10%	GCG21BR71H184KA01#	
			0.22μF	±10%	GCG21BR71H224KA01#	
			0.33μF	±10%	GCG21BR71H334KA01#	
			0.47μF	±10%	GCG21BR71H474KA01#	
			1.0μF	±10%	GCG21BR71H105KA01#	
	35Vdc	X8L	0.68μF	±10%	GCG21BL8EG684KA07#	<b>D4</b>
			1.0μF	±10%	GCG21BL8EG105KA07#	<b>D4</b>
		X7R	0.68μF	±10%	GCG21BR7YA684KA01#	
			1.0μF	±10%	GCG21BR7YA105KA01#	
	25Vdc	X8L	0.33μF	±10%	GCG21BL81E334KA01#	
			X8R	0.68μF	±10%	GCG21BR91E684KE01#
			1.0μF	±10%	GCG21BR91E105KE01#	
		X7R	0.27μF	±10%	GCG21BR71E274KA01#	
			0.33μF	±10%	GCG21BR71E334KA01#	
			0.39μF	±10%	GCG21BR71E394KA01#	
			0.47μF	±10%	GCG21BR71E474KA01#	
			0.56μF	±10%	GCG21BR71E564KA01#	
			0.68μF	±10%	GCG21BR71E684KA01#	
			0.82μF	±10%	GCG21BR71E824KA01#	
	1.0μF		±10%	GCG21BR71E105KA12#		
	16Vdc	X8L	0.33μF	±10%	GCG21BL81C334KA01#	
			0.39μF	±10%	GCG21BL81C394KA01#	
			0.47μF	±10%	GCG21BL81C474KA01#	
			0.56μF	±10%	GCG21BL81C564KA01#	
			0.68μF	±10%	GCG21BL81C684KA01#	
			0.82μF	±10%	GCG21BL81C824KA01#	
		X7R	4.7μF	±10%	GCG21BR71C475KA12#	
		10Vdc	X7R	10μF	±10%	GCG21BR71A106KE01#
	6.3Vdc	X8L	10μF	±10%	GCG21BL8EC106KE07#	<b>D4</b>
			X7R	10μF	±10%	GCG21BR70J106KE01#

3.2×1.6mm

T max.	Rated Voltage	TC Code	Cap.	Tol.	Part Number	
1.35mm	50Vdc	X8R	0.22μF	±10%	GCG31MR91H224KA03#	
			0.33μF	±10%	GCG31MR91H334KA03#	
	25Vdc	X7R	1.2μF	±10%	GCG31MR71E125KA01#	

T max.	Rated Voltage	TC Code	Cap.	Tol.	Part Number	
1.35mm	25Vdc	X7R	1.5μF	±10%	GCG31MR71E155KA01#	
			2.2μF	±10%	GCG31MR71E225KA12#	
	16Vdc	X8L	1.0μF	±10%	GCG31ML81C105KA01#	
			1.5μF	±10%	GCG31ML81C155KA01#	
1.9mm	25Vdc	X7R	3.3μF	±10%	GCG31CR71E335KA01#	
			3.9μF	±10%	GCG31CR71E395KA01#	
			4.7μF	±10%	GCG31CR71E475KA01#	
			16Vdc	X8L	3.3μF	±10%
	4.7μF	±10%	GCG31CL81C475KA01#			
		X8R	0.68μF	±10%	GCG31CR91C684KA01#	
			1.0μF	±10%	GCG31CR91C105KA01#	
	6.3Vdc	X7R	22μF	±10%	GCG31CR70J226KE01#	

3.2×2.5mm

T max.	Rated Voltage	TC Code	Cap.	Tol.	Part Number	
2.8mm	50Vdc	X8L	10μF	±10%	GCG32EL8EH106KA07#	<b>D4</b>
			X7S	10μF	±10%	GCG32EC71H106KA01#
	35Vdc	X8L	10μF	±10%	GCG32EL8EG106KA07#	<b>D4</b>
			X7S	10μF	±10%	GCG32EC7YA106KA01#
	25Vdc	X8L	22μF	±10%	GCG32EL8EF226KE07#	<b>D4</b>
			X7R	10μF	±10%	GCG32ER71E106KA12#
		X7S	22μF	±10%	GCG32EC71E226KE01#	
			16Vdc	X8R	6.8μF	±10%
	10μF	±10%	GCG32ER91C106KE01#			
	6.3Vdc	X7R	47μF	±10%	GCG32ER70J476KE01#	

Part number # indicates the package specification code.

GRT Series  
 GCM Series  
 GC3 Series  
 GCJ Series  
 GCQ Series  
 GCD Series  
 GCE Series  
 NMF Series  
 KCM Series  
 KC3 Series  
 KCA Series  
 GCG Series  
 ⚠Caution/ Notice

## ⚠️Caution/Notice



**Target series: GRT, GCM, GC3, GCJ, GCQ, GCD, GCE, NFM, KCM, KC3, KCA, GCG**

### ⚠️Caution

Storage and Operation Conditions .....	78
Rating .....	78
1. Temperature Dependent Characteristics .....	78
2. Measurement of Capacitance .....	78
3. Applied Voltage and Applied Current .....	79
4. Type of Applied Voltage and Self-heating Temperature .....	79
5. DC Voltage and AC Voltage Characteristics .....	81
6. Capacitance Aging .....	81
7. Vibration and Shock .....	82
Soldering and Mounting .....	82
1. Mounting Position .....	82
2. Information before Mounting .....	83
3. Maintenance of the Mounting (pick and place) Machine .....	83
4-1. Reflow Soldering .....	84
4-2. Flow Soldering .....	85
4-3. Correction of Soldered Portion .....	86
5. Washing .....	87
6. Electrical Test on Printed Circuit Board .....	87
7. Printed Circuit Board Cropping .....	87
8. Assembly .....	90
9. Selection of Conductive Adhesive, Mounting Process, and Bonding Strength .....	91
10. Moisture Proof Process .....	91
11. Application .....	91
Other .....	91
1. Under Operation of Equipment .....	91
2. Other .....	91

### Notice

Rating .....	92
1. Operating Temperature .....	92
2. Atmosphere Surroundings (gaseous and liquid) .....	92
3. Piezo-electric Phenomenon .....	92
Soldering and Mounting .....	92
1. PCB Design .....	92
1. Notice for Pattern Forms .....	92
2. Land Dimensions .....	93
3. Board Design .....	95
2. Item to be confirmed for Flow soldering .....	95
3. Reflow Soldering .....	96
4. Washing .....	97
5. Coating .....	97
Other .....	97
1. Transportation .....	97
2. Characteristics Evaluation in the Actual System .....	97

GRT Series

GCM Series

GC3 Series

GCJ Series

GCQ Series

GCD Series

GCE Series

NFM Series

KCM Series

KC3 Series

KCA Series

GCG Series

⚠️Caution /Notice

GRT Series  
 GCM Series  
 GC3 Series  
 GCJ Series  
 GCQ Series  
 GCD Series  
 GCE Series  
 NMF Series  
 KCM Series  
 KC3 Series  
 KCA Series  
 GCG Series  
 ⚠Caution

**⚠Caution**

**Storage and Operation Conditions**

1. The performance of chip multilayer ceramic capacitors (henceforth just "capacitors") may be affected by the storage conditions.

Please use them promptly after delivery.

- 1-1. Maintain appropriate storage for the capacitors using the following conditions:  
 Room Temperature of +5°C to +40°C and a Relative Humidity of 20% to 70%.  
 High temperature and humidity conditions and/or prolonged storage may cause deterioration of the packaging materials. If more than six months have elapsed since delivery, check packaging, mounting, etc. before use.

In addition, this may cause oxidation of the electrodes. If more than one year has elapsed since delivery, also check the solderability before use.

1-2. Corrosive gas can react with the termination (external) electrodes or lead wires of capacitors, and result in poor solderability. Do not store the capacitors in an atmosphere consisting of corrosive gas (e.g., hydrogen sulfide, sulfur dioxide, chlorine, ammonia gas etc.).

1-3. Due to moisture condensation caused by rapid humidity changes, or the photochemical change caused by direct sunlight on the terminal electrodes and/or the resin/epoxy coatings, the solderability and electrical performance may deteriorate. Do not store capacitors under direct sunlight or in high humidity conditions

**<Applicable to GCG Series>**

1-4. After unpacking, immediately reseal, or store in a desiccator containing a desiccant.

**Rating**

**1. Temperature Dependent Characteristics**

1. The electrical characteristics of a capacitor can change with temperature.

- 1-1. For capacitors having larger temperature dependency, the capacitance may change with temperature changes.  
 The following actions are recommended in order to ensure suitable capacitance values.  
 (1) Select a suitable capacitance for the operating temperature range.

(2) The capacitance may change within the rated temperature.

When you use a high dielectric constant type capacitor in a circuit that needs a tight (narrow) capacitance tolerance (e.g., a time-constant circuit), please carefully consider the temperature characteristics, and carefully confirm the various characteristics in actual use conditions and the actual system.

[Example of Temperature Characteristics X7R(R7)]

Sample: 0.1μF, Rated Voltage 50VDC

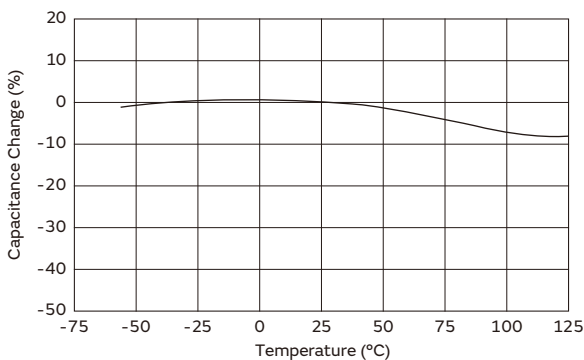

[Example of Temperature Characteristics X5R (R6)]

Sample: 22μF, Rated Voltage 4VDC

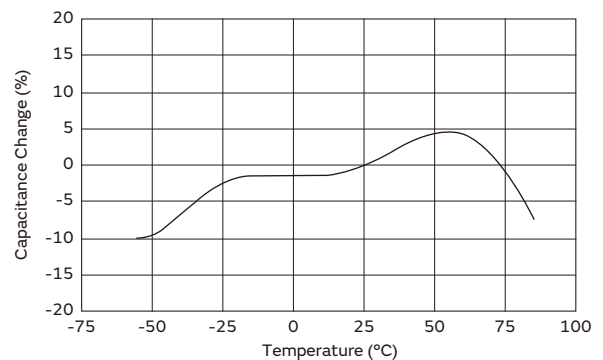

**2. Measurement of Capacitance**

1. Measure capacitance with the voltage and frequency specified in the product specifications.

- 1-1. The output voltage of the measuring equipment may decrease occasionally when capacitance is high. Please confirm whether a prescribed measured voltage is impressed to the capacitor.

1-2. The capacitance values of high dielectric constant type capacitors change depending on the AC voltage applied. Please consider the AC voltage characteristics when selecting a capacitor to be used in an AC circuit.

Continued on the following page. ↗





Continued from the preceding page. ↘

### 3. Applied Voltage and Applied Current

1. Do not apply a voltage to the capacitor that exceeds the rated voltage as called out in the specifications.
  - 1-1. Applied voltage between the terminals of a capacitor shall be less than or equal to the rated voltage.
    - (1) When AC voltage is superimposed on DC voltage, the zero-to-peak voltage shall not exceed the rated DC voltage.  
 When AC voltage or pulse voltage is applied, the peak-to-peak voltage shall not exceed the rated DC voltage.
    - (2) Abnormal voltages (surge voltage, static electricity, pulse voltage, etc.) shall not exceed the rated DC voltage.

Typical Voltage Applied to the DC Capacitor

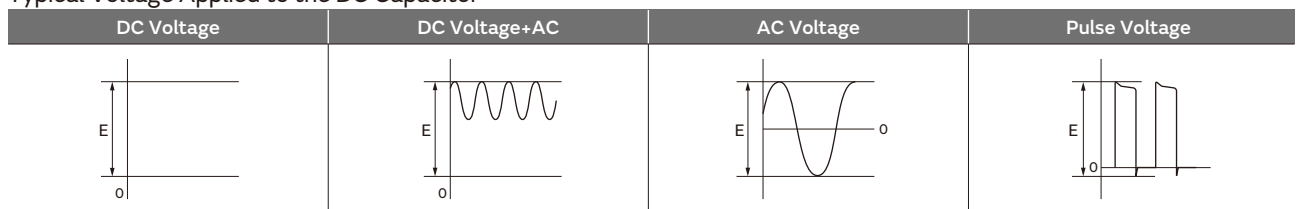

(E: Maximum possible applied voltage.)

- 1-2. Influence of over voltage  
 Over voltage that is applied to the capacitor may result in an electrical short circuit caused by the breakdown of the internal dielectric layers. The time duration until breakdown depends on the applied voltage and the ambient temperature.
2. Use a safety standard certified capacitor in a power supply input circuit (AC filter), as it is also necessary to consider the withstand voltage and impulse withstand voltage defined for each device.

### 4. Type of Applied Voltage and Self-heating Temperature

1. Confirm the operating conditions to make sure that no large current is flowing into the capacitor due to the continuous application of an AC voltage or pulse voltage.  
 When a DC rated voltage product is used in an AC voltage circuit or a pulse voltage circuit, the AC current or pulse current will flow into the capacitor; therefore check the self-heating condition.  
 Please confirm the surface temperature of the capacitor so that the temperature remains within the upper limits of the operating temperature, including the rise in temperature due to self-heating. When the capacitor is used with a high-frequency voltage or pulse voltage, heat may be generated by dielectric loss.  
**<Applicable to Rated Voltage of less than 100VDC>**
  - 1-1. The load should be contained so that the self-heating of the capacitor body remains below 20°C, when measuring at an ambient temperature of 25°C.

<Applicable to NFM Series>

3. The capacitors also have rated currents.  
 The current flowing between the terminals of a capacitor shall be less than or equal to the rated current. Using the capacitor beyond this range could lead to excessive heat.

[Example of Temperature Rise (Heat Generation) in Chip Multilayer Ceramic Capacitors in Contrast to Ripple Current]

Sample: R(R1) characteristics 10μF,  
 Rated voltage: DC10V

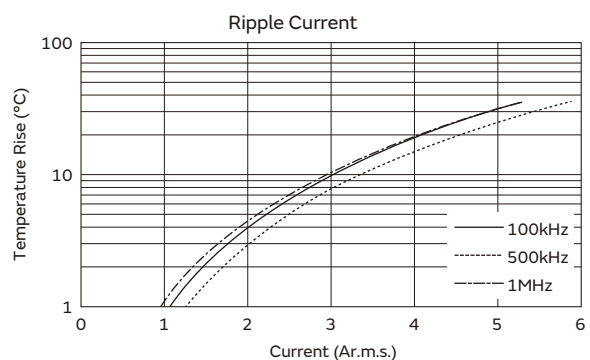

Continued on the following page. ↗

**⚠Caution**

Continued from the preceding page. ↘

**<Applicable to Temperature Characteristics X7R(R7), X7T(D7) beyond Rated Voltage of 250VDC>**

1-2. The load should be contained so that the self-heating of the capacitor body remains below 20°C, when measuring at an ambient temperature of 25°C. In addition, use a K thermocouple of  $\varnothing 0.1\text{mm}$  with less heat capacity when measuring, and measure in a condition where there is no effect from the radiant heat of other components or air flow caused by convection. Excessive generation of heat may cause deterioration of the characteristics and reliability of the capacitor. (Absolutely do not perform measurements while the cooling fan is operating, as an accurate measurement may not be performed.)

**<Applicable to Temperature Characteristics U2J(7U), COG(5C) beyond Rated Voltage of 250VDC>**

1-3. Since the self-heating is low in the low loss series, the allowable power becomes extremely high compared to the common X7R(R7) characteristics. However, when a load with self-heating of 20°C is applied at the rated voltage, the allowable power may be exceeded. When the capacitor is used in a high-frequency voltage circuit of 1kHz or more, the frequency of the applied voltage should be less than 500kHz sine wave (less than 100kHz for a product with rated voltage of DC3.15kV), to limit the voltage load so that the load remains within the derating shown in the following figure. In the case of non-sine wave, high-frequency components exceeding the fundamental frequency may be included. In such a case, please contact Murata. The excessive generation of heat may cause deterioration of the characteristics and reliability of the capacitor. (Absolutely do not perform measurements while the cooling fan is operating, as an accurate measurement may not be performed.)

[Sine-wave frequency VS allowable voltage]

The surface temperature of the capacitor: 125°C or less (including self-heating)

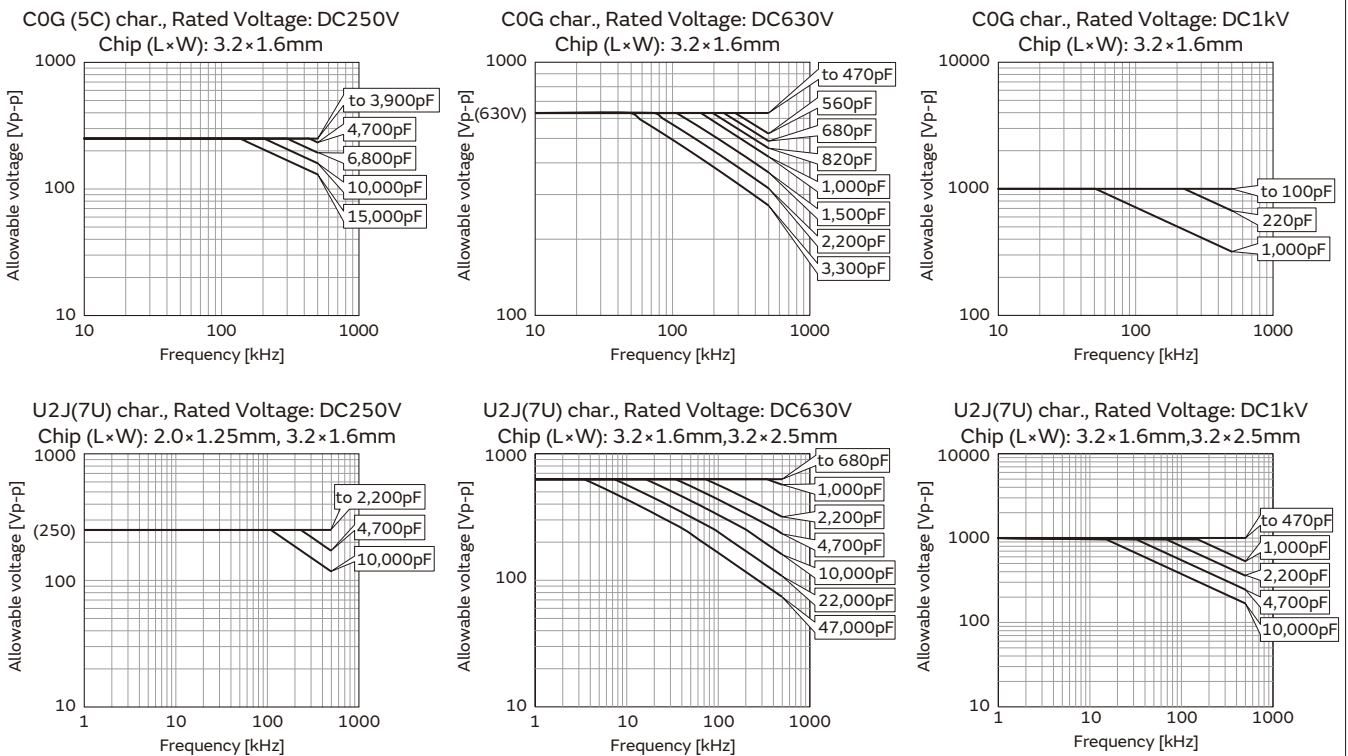

Continued on the following page. ↗



Continued from the preceding page. ↘

## 5. DC Voltage and AC Voltage Characteristics

1. The capacitance value of a high dielectric constant type capacitor changes depending on the DC voltage applied. Please consider the DC voltage characteristics when a capacitor is selected for use in a DC circuit.

1-1. The capacitance of ceramic capacitors may change sharply depending on the applied voltage (see figure). Please confirm the following in order to secure the capacitance.

- (1) Determine whether the capacitance change caused by the applied voltage is within the allowed range.
- (2) In the DC voltage characteristics, the rate of capacitance change becomes larger as voltage increases, even if the applied voltage is below the rated voltage. When a high dielectric constant type capacitor is used in a circuit that requires a tight (narrow) capacitance tolerance (e.g., a time constant circuit), please carefully consider the voltage characteristics, and confirm the various characteristics in the actual operating conditions of the system.

2. The capacitance values of high dielectric constant type capacitors changes depending on the AC voltage applied. Please consider the AC voltage characteristics when selecting a capacitor to be used in an AC circuit.

[Example of DC Voltage Characteristics]

Sample: R(R1) Characteristics 0.1 $\mu$ F,  
 Rated Voltage 50VDC

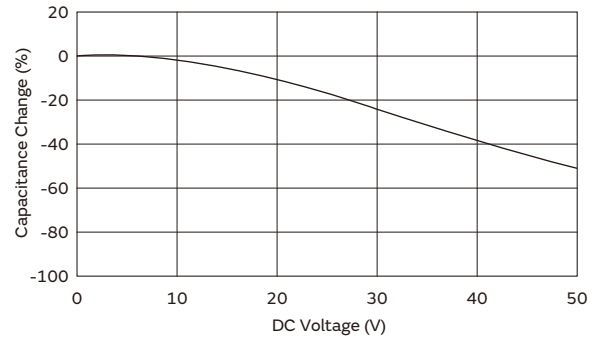

[Example of AC Voltage Characteristics]

Sample: X7R(R7) Characteristics 10 $\mu$ F,  
 Rated Voltage 6.3VDC

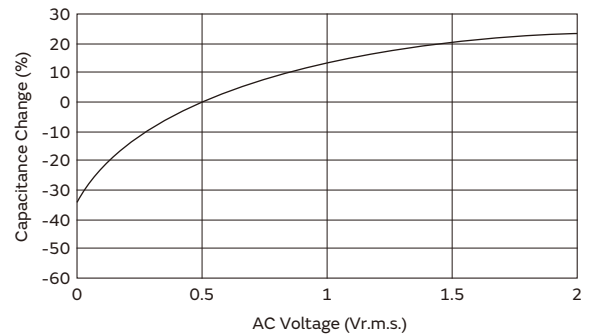

## 6. Capacitance Aging

1. The high dielectric constant type capacitors have the Characteristics in which the capacitance value decreases with the passage of time.

When you use high dielectric constant type capacitors in a circuit that needs a tight (narrow) capacitance tolerance (e.g., a time-constant circuit), please carefully consider the characteristics of these capacitors, such as their aging, voltage, and temperature characteristics. In addition, check capacitors using your actual appliances at the intended environment and operating conditions.

[Example of Change Over Time (Aging Characteristics)]

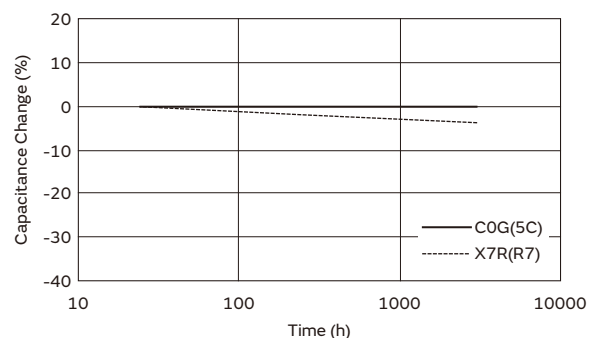

Continued on the following page. ↗

GRT Series

GCM Series

GC3 Series

GCJ Series

GCQ Series

GCD Series

GCE Series

NMF Series

KCM Series

KC3 Series

KCA Series

GCG Series

⚠Caution

GRT Series  
 GCM Series  
 GC3 Series  
 GCJ Series  
 GCQ Series  
 GCD Series  
 GCE Series  
 NMF Series  
 KCM Series  
 KC3 Series  
 KCA Series  
 GCG Series  
 ⚠Caution

**⚠Caution**

Continued from the preceding page. ↘

**7. Vibration and Shock**

1. Please confirm the kind of vibration and/or shock, its condition, and any generation of resonance.  
 Please mount the capacitor so as not to generate resonance, and do not allow any impact on the terminals.
2. Mechanical shock due to being dropped may cause damage or a crack in the dielectric material of the capacitor.  
 Do not use a dropped capacitor because the quality and reliability may be deteriorated.
3. When printed circuit boards are piled up or handled, the corner of another printed circuit board should not be allowed to hit the capacitor, in order to avoid a crack or other damage to the capacitor.

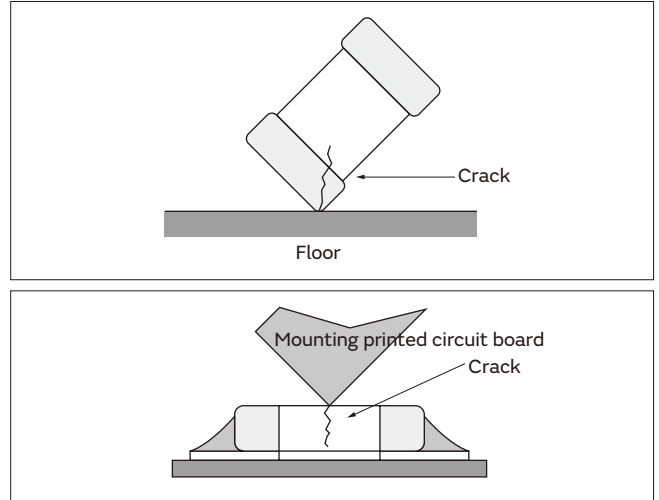

**Soldering and Mounting**

**1. Mounting Position**

1. Confirm the best mounting position and direction that minimizes the stress imposed on the capacitor during flexing or bending the printed circuit board.  
 1-1. Choose a mounting position that minimizes the stress imposed on the chip during flexing or bending of the board.

**<Applicable to NFM Series>**

2. If you mount the capacitor near components that generate heat, take note of the heat from the other components and carefully check the self-heating of the capacitor before using.  
 If there is significant heat radiation from other components, it could lower the insulation resistance of the capacitor or produce excessive heat.

**[Component Direction]**

**[Chip Mounting Close to Board Separation Point]**

It is effective to implement the following measures, to reduce stress in separating the board.  
 It is best to implement all of the following three measures; however, implement as many measures as possible to reduce stress.

Contents of Measures	Stress Level
(1) Turn the mounting direction of the component parallel to the board separation surface.	A > D *1
(2) Add slits in the board separation part.	A > B
(3) Keep the mounting position of the component away from the board separation surface.	A > C

\*1 A > D is valid when stress is added vertically to the perforation as with Hand Separation.  
 If a Cutting Disc is used, stress will be diagonal to the PCB, therefore A > D is invalid.

**[Mounting Capacitors Near Screw Holes]**

When a capacitor is mounted near a screw hole, it may be affected by the board deflection that occurs during the tightening of the screw. Mount the capacitor in a position as far away from the screw holes as possible.

Continued on the following page. ↗



Continued from the preceding page. ↘

## 2. Information before Mounting

1. Do not re-use capacitors that were removed from the equipment.
2. Confirm capacitance characteristics under actual applied voltage.
3. Confirm the mechanical stress under actual process and equipment use.
4. Confirm the rated capacitance, rated voltage and other electrical characteristics before assembly.
5. Prior to use, confirm the solderability of capacitors that were in long-term storage.
6. Prior to measuring capacitance, carry out a heat treatment for capacitors that were in long-term storage.
7. The use of Sn-Zn based solder will deteriorate the reliability of the MLCC.

Please contact our sales representative or product engineers on the use of Sn-Zn based solder in advance.

8. We have also produced a DVD which shows a summary of our recommendations, regarding the precautions for mounting. Please contact our sales representative to request the DVD.

## 3. Maintenance of the Mounting (pick and place) Machine

1. Make sure that the following excessive forces are not applied to the capacitors. Check the mounting in the actual device under actual use conditions ahead of time.

1-1. In mounting the capacitors on the printed circuit board, any bending force against them shall be kept to a minimum to prevent them from any damage or cracking. Please take into account the following precautions and recommendations for use in your process.

- (1) Adjust the lowest position of the pickup nozzle so as not to bend the printed circuit board.

2. Dirt particles and dust accumulated in the suction nozzle and suction mechanism prevent the nozzle from moving smoothly. This creates excessive force on the capacitor during mounting, causing cracked chips. Also, the locating claw, when worn out, imposes uneven forces on the chip when positioning, causing cracked chips. The suction nozzle and the locating claw must be maintained, checked, and replaced periodically.

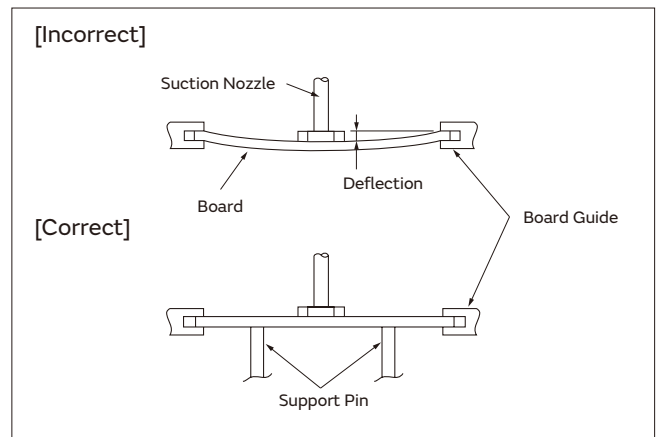

Continued on the following page. ↗

GRT Series  
 GCM Series  
 GC3 Series  
 GCJ Series  
 GCQ Series  
 GCD Series  
 GCE Series  
 NMF Series  
 KCM Series  
 KC3 Series  
 KCA Series  
 GCG Series  
 ⚠Caution

**⚠Caution**

Continued from the preceding page. ↘

**4-1. Reflow Soldering**

- When sudden heat is applied to the components, the mechanical strength of the components will decrease because a sudden temperature change causes deformation inside the components. In order to prevent mechanical damage to the components, preheating is required for both the components and the PCB. Preheating conditions are shown in table 1. It is required to keep the temperature differential between the solder and the components surface ( $\Delta T$ ) as small as possible.
- When components are immersed in solvent after mounting, be sure to maintain the temperature difference ( $\Delta T$ ) between the component and the solvent within the range shown in table 1.

**Table 1**

Series	Chip Dimension Code (L/W)	Temperature Differential
GRT/GCM/GC3/GCD/GCE/GCJ/NFM	03/15/18/21/31	$\Delta T \leq 190^\circ\text{C}$
GRT/GCM/GCJ	32/43/55	$\Delta T \leq 130^\circ\text{C}$
KCM/KC3/KCA	55	

**Recommended Conditions**

	Pb-Sn Solder	Lead Free Solder
Peak Temperature	230 to 250°C	240 to 260°C
Atmosphere	Air	Air or N <sub>2</sub>

Pb-Sn Solder: Sn-37Pb  
 Lead Free Solder: Sn-3.0Ag-0.5Cu

- When a capacitor is mounted at a temperature lower than the peak reflow temperature recommended by the solder manufacturer, the following quality problems can occur. Consider factors such as the placement of peripheral components and the reflow temperature setting to prevent the capacitor's reflow temperature from dropping below the peak temperature specified. Be sure to evaluate the mounting situation beforehand and verify that none of the following problems occur.

- Drop in solder wettability
- Solder voids
- Possible occurrence of whiskering
- Drop in bonding strength
- Drop in self-alignment properties
- Possible occurrence of tombstones and/or shifting on the land patterns of the circuit board

**4. Optimum Solder Amount for Reflow Soldering**

- Overly thick application of solder paste results in a excessive solder fillet height. This makes the chip more susceptible to mechanical and thermal stress on the board and may cause the chips to crack.

**Inverting the PCB**

Make sure not to impose any abnormal mechanical shocks to the PCB.

**[Example of Temperature Conditions for Reflow Soldering]**

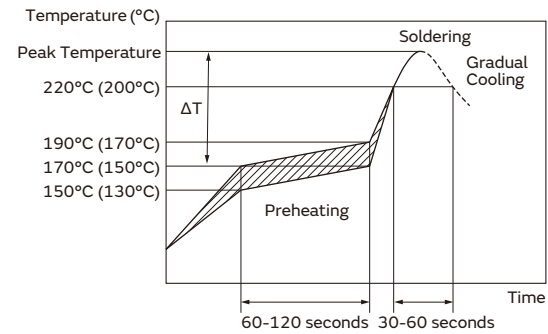

Temperature  
 Incase of Lead Free Solder  
 ( ): In case of Pb-Sn Solder

**[Allowable Reflow Soldering Temperature and Time]**

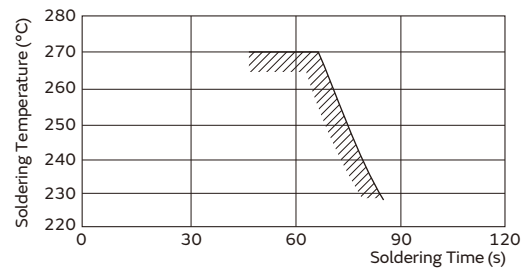

In the case of repeated soldering, the accumulated soldering time must be within the range shown above.

- Too little solder paste results in a lack of adhesive strength on the termination, which may result in chips breaking loose from the PCB.
- Please confirm that solder has been applied smoothly to the termination.

**<Applicable to NFM Series>**

**[Guideline of solder paste thickness]**

100-150μm: NFM21HC/31HK

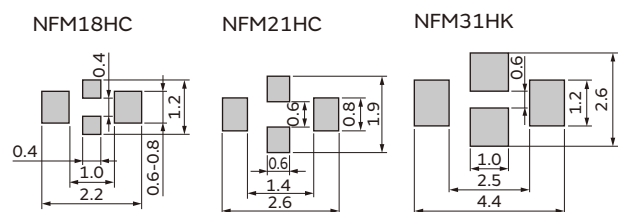



Continued from the preceding page. ↘

## 4-2. Flow Soldering

1. Do not apply flow soldering to chips not listed in table 2.

Table 2

Series	Chip Dimension Code (L/W)	Temperature Differential
<b>GRT/GCM/GC3/GCD</b> (Except for characteristics of X8L(L8), X8G(5G), CHA(0C), X8R(R9))	<b>18/21/31</b>	$\Delta T \leq 150^\circ\text{C}$
<b>GCJ</b> (Rated Voltage 250VDC or more)		
<b>NFM</b>		

- When sudden heat is applied to the components, the mechanical strength of the components will decrease because a sudden temperature change causes deformation inside the components. In order to prevent mechanical damage to the components, preheating is required for both of the components and the PCB. Preheating conditions are shown in table 2. It is required to keep the temperature differential between the solder and the components surface ( $\Delta T$ ) as low as possible.
- Excessively long soldering time or high soldering temperature can result in leaching of the terminations, causing poor adhesion or a reduction in capacitance value due to loss of contact between the inner electrodes and terminations.
- When components are immersed in solvent after mounting, be sure to maintain the temperature differential ( $\Delta T$ ) between the component and solvent within the range shown in the table 2.

### Recommended Conditions

	Pb-Sn Solder	Lead Free Solder
Preheating Peak Temperature	90 to 110°C	100 to 120°C 140 to 160°C (NFM)
Soldering Peak Temperature	240 to 250°C	250 to 260°C
Atmosphere	Air	Air or N <sub>2</sub>

Pb-Sn Solder: Sn-37Pb

Lead Free Solder: Sn-3.0Ag-0.5Cu

### 5. Optimum Solder Amount for Flow Soldering

- The top of the solder fillet should be lower than the thickness of the components. If the solder amount is excessive, the risk of cracking is higher during board bending or any other stressful condition.

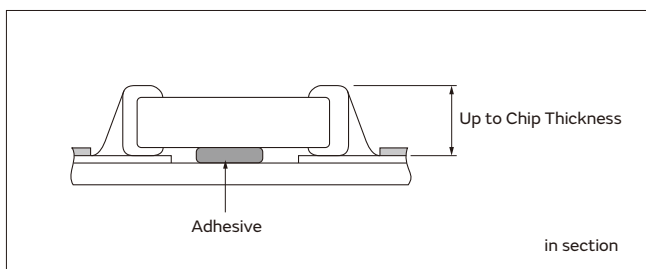

[Example of Temperature Conditions for Flow Soldering]

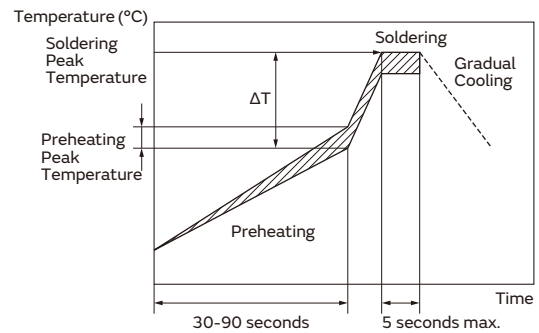

[Allowable Flow Soldering Temperature and Time]

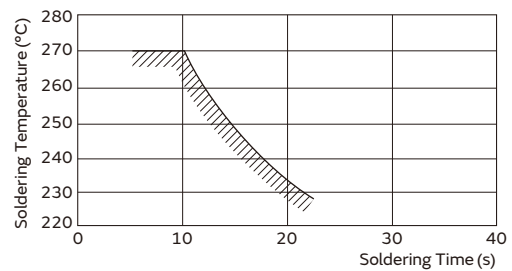

In the case of repeated soldering, the accumulated soldering time must be within the range shown above.

Continued on the following page. ↗

GRT Series

GCM Series

GC3 Series

GCJ Series

GCQ Series

GCD Series

GCE Series

NMF Series

KCM Series

KC3 Series

KCA Series

GCG Series

⚠Caution

GRT Series  
 GCM Series  
 GC3 Series  
 GCJ Series  
 GCQ Series  
 GCD Series  
 GCE Series  
 NMF Series  
 KCM Series  
 KC3 Series  
 KCA Series  
 GCG Series  
 ⚠Caution

**⚠Caution**

Continued from the preceding page. ↘

**4-3. Correction of Soldered Portion**

When sudden heat is applied to the capacitor, distortion caused by the large temperature difference occurs internally, and can be the cause of cracks. Capacitors also tend to be affected by mechanical and thermal stress depending on the board preheating temperature or the soldering fillet shape, and can be the cause of cracks. Please refer to "1. PCB Design" or "3. Optimum solder amount" for the solder amount and the fillet shapes.

**1. Correction with a Soldering Iron**

- 1-1. In order to reduce damage to the capacitor, be sure to preheat the capacitor and the mounting board. Preheat to the temperature range shown in Table 3. A hot plate, hot air type preheater, etc. can be used for preheating.

- 1-2. After soldering, do not allow the component/PCB to cool down rapidly.
- 1-3. Perform the corrections with a soldering iron as quickly as possible. If the soldering iron is applied too long, there is a possibility of causing solder leaching on the terminal electrodes, which will cause deterioration of the adhesive strength and other problems.

**Table 3**

Series	Chip Dimension Code (L/W)	Temperature of Soldering Iron Tip	Preheating Temperature	Temperature Differential (ΔT)	Atmosphere
GRT/GCM/GC3/GCD/GCE/GCJ	03/15/18/21/31	350°C max.	150°C min.	ΔT≤190°C	Air
GRT/GCM/GCJ	32/43/55	280°C max.	150°C min.	ΔT≤130°C	Air
NFM	21/31	350°C max.	150°C min.	ΔT≤190°C	Air

\*Applicable for both Pb-Sn and Lead Free Solder.  
 Pb-Sn Solder: Sn-37Pb  
 Lead Free Solder: Sn-3.0Ag-0.5Cu  
 \*Please manage ΔT in the temperature of soldering iron and the preheating temperature.

**2. Correction with Spot Heater**

Compared to local heating with a soldering iron, hot air heating by a spot heater heats the overall component and board, therefore, it tends to lessen the thermal shock. In the case of a high density mounted board, a spot heater can also prevent concerns of the soldering iron making direct contact with the component.

- 2-1. If the distance from the hot air outlet of the spot heater to the component is too close, cracks may occur due to thermal shock. To prevent this problem, follow the conditions shown in Table 4.

**Table 4**

Distance	5mm or more
Hot Air Application Angle	45° *Figure 1
Hot Air Temperature Nozzle Outlet	400°C max.
Application Time	Less than 10 seconds (1206 (3216M) size or smaller)
	Less than 30 seconds (1210 (3225M) size or larger)

- 2-2. In order to create an appropriate solder fillet shape, it is recommended that hot air be applied at the angle shown in Figure 1.

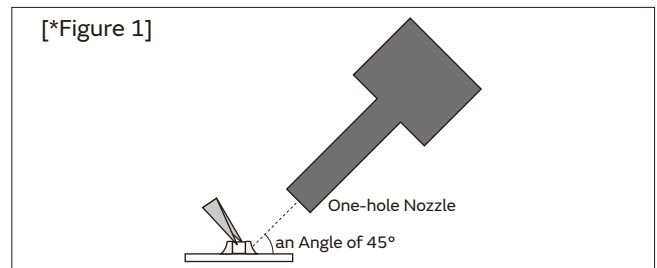

**3. Optimum solder amount when re-working with a soldering iron**

- 3-1. If the solder amount is excessive, the risk of cracking is higher during board bending or any other stressful condition.

Too little solder amount results in a lack of adhesive strength on the outer electrode termination, which may result in chips breaking loose from the PCB. Please confirm that solder has been applied smoothly is and rising to the end surface of the chip.

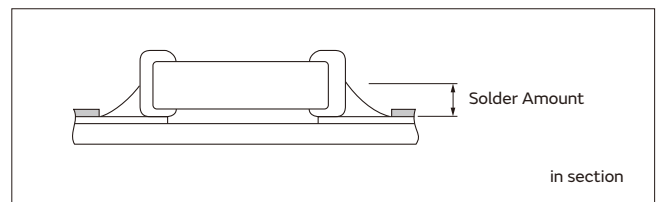

Continued on the following page. ↗





Continued from the preceding page. ↘

- 3-2. A soldering iron with a tip of  $\varnothing 3\text{mm}$  or smaller should be used. It is also necessary to keep the soldering iron from touching the components during the re-work.
- 3-3. Solder wire with  $\varnothing 0.5\text{mm}$  or smaller is required for soldering.

**<Applicable to KCM/KC3/KCA Series>**

4. For the shape of the soldering iron tip, refer to the figure on the right.

Regarding the type of solder, use a wire diameter of  $\varnothing 0.5\text{mm}$  or less (rosin core wire solder).

**4-1. How to Apply the Soldering Iron**

Apply the tip of the soldering iron against the lower end of the metal terminal.

- 1) In order to prevent cracking caused by sudden heating of the ceramic device, do not touch the ceramic base directly.
- 2) In order to prevent deviations and dislocating of the chip, do not touch the junction of the chip and the metal terminal, and the metal portion on the outside directly.

**4-2. Appropriate Amount of Solder**

The amount of solder for corrections by soldering iron, should be lower than the height of the lower side of the chip.

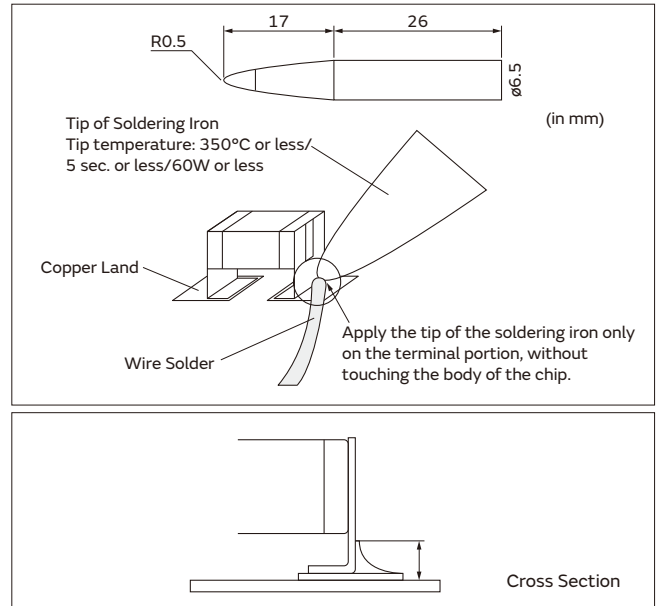

**5. Washing**

Excessive ultrasonic oscillation during cleaning can cause the PCBs to resonate, resulting in cracked chips or broken solder joints. Before starting your production process, test your cleaning equipment/process to insure it does not degrade the capacitors.

**6. Electrical Test on Printed Circuit Board**

1. Confirm position of the support pin or specific jig, when inspecting the electrical performance of a capacitor after mounting on the printed circuit board.

1-1. Avoid bending the printed circuit board by the pressure of a test-probe, etc.

The thrusting force of the test probe can flex the PCB, resulting in cracked chips or open solder joints. Provide support pins on the back side of the PCB to prevent warping or flexing. Install support pins as close to the test-probe as possible.

1-2. Avoid vibration of the board by shock when a test-probe contacts a printed circuit board.

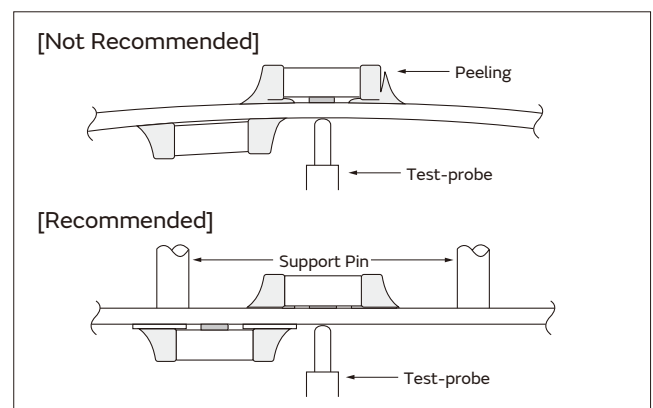

**7. Printed Circuit Board Cropping**

1. After mounting a capacitor on a printed circuit board, do not apply any stress to the capacitor that causes bending or twisting the board.

1-1. In cropping the board, the stress as shown at right may cause the capacitor to crack.

Avoid this type of stress to a capacitor.

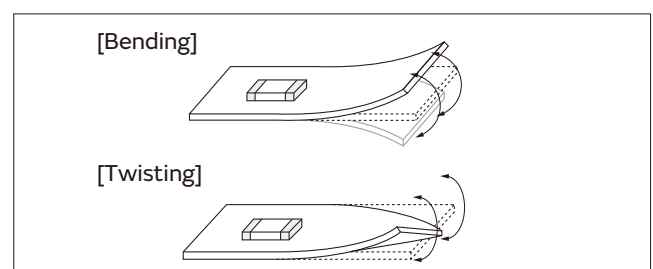

Continued on the following page. ↗

GRT Series  
 GCM Series  
 GC3 Series  
 GCJ Series  
 GCQ Series  
 GCD Series  
 GCE Series  
 NMF Series  
 KCM Series  
 KC3 Series  
 KCA Series  
 GCG Series  
 ⚠Caution

## ⚠Caution

Continued from the preceding page. ↘

### 2. Check the cropping method for the printed circuit board in advance.

2-1. Printed circuit board cropping shall be carried out by using a jig or an apparatus (Disc separator, router type separator, etc.) to prevent the mechanical stress that can occur to the board.

Board Separation Method	Hand Separation Nipper Separation	(1) Board Separation Jig	Board Separation Apparatus	
			(2) Disc Separator	(3) Router Type Separator
Level of stress on board	High	Medium	Medium	Low
Recommended	×	△*	△*	○
Notes	Hand and nipper separation apply a high level of stress. Use another method.	<ul style="list-style-type: none"> <li>Board handling</li> <li>Board bending direction</li> <li>Layout of capacitors</li> </ul>	<ul style="list-style-type: none"> <li>Board handling</li> <li>Layout of slits</li> <li>Design of V groove</li> <li>Arrangement of blades</li> <li>Controlling blade life</li> </ul>	Board handling

\* When a board separation jig or disc separator is used, if the following precautions are not observed, a large board deflection stress will occur and the capacitors may crack. Use router type separator if at all possible.

#### (1) Example of a suitable jig

[In the case of Single-side Mounting]

An outline of the board separation jig is shown as follows. Recommended example: Stress on the component mounting position can be minimized by holding the portion close to the jig, and bend in the direction towards the side where the capacitors are mounted. Not recommended example: The risk of cracks occurring in the capacitors increases due to large stress being applied to the component mounting position, if the portion away from the jig is held and bent in the direction opposite the side where the capacitors are mounted.

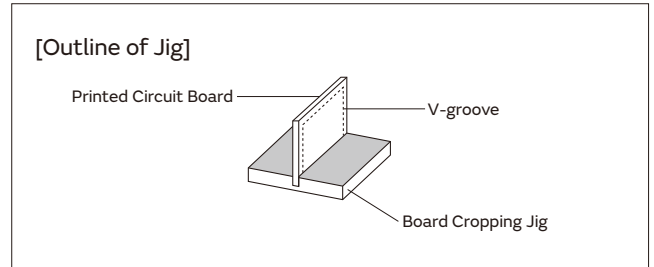

#### Hand Separation

Recommended	Not Recommended

[In the case of Double-sided Mounting]

Since components are mounted on both sides of the board, the risk of cracks occurring can not be avoided with the above method. Therefore, implement the following measures to prevent stress from being applied to the components.

(Measures)

- Consider introducing a router type separator. If it is difficult to introduce a router type separator, implement the following measures. (Refer to item 1. Mounting Position)
- Mount the components parallel to the board separation surface.
- When mounting components near the board separation point, add slits in the separation position near the component.
- Keep the mounting position of the components away from the board separation point.

Continued on the following page. ↗



Continued from the preceding page. ↘

(2) Example of a Disc Separator

An outline of a disc separator is shown as follows. As shown in the Principle of Operation, the top blade and bottom blade are aligned with the V-grooves on the printed circuit board to separate the board.

In the following case, board deflection stress will be applied and cause cracks in the capacitors.

- (1) When the adjustment of the top and bottom blades are misaligned, such as deviating in the top-bottom, left-right or front-rear directions
- (2) The angle of the V groove is too low, depth of the V groove is too shallow, or the V groove is misaligned top-bottom

IF V groove is too deep, it is possible to brake when you handle and carry it. Carefully design depth of the V groove with consideration about strength of material of the printed circuit board.

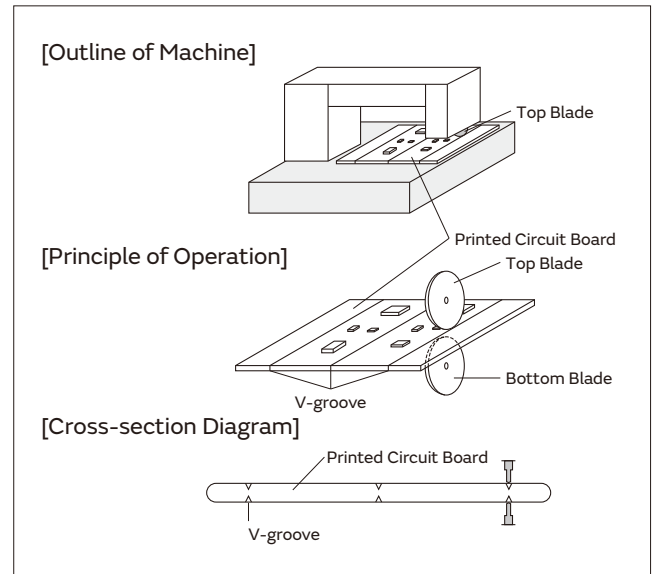

**Disc Separator**

Recommended	Not Recommended		
	Top-bottom Misalignment	Left-right Misalignment	Front-rear Misalignment
<p>Top Blade</p> <p>Bottom Blade</p>	<p>Top Blade</p> <p>Bottom Blade</p>	<p>Top Blade</p> <p>Bottom Blade</p>	<p>Top Blade</p> <p>Bottom Blade</p>

**V-groove Design**

Example of Recommended V-groove Design	Not Recommended			
	Left-right Misalignment	Low-Angle	Depth too Shallow	Depth too Deep

(3) Example of Router Type Separator

The router type separator performs cutting by a router rotating at a high speed. Since the board does not bend in the cutting process, stress on the board can be suppressed during board separation.

When attaching or removing boards to/from the router type separator, carefully handle the boards to prevent bending.

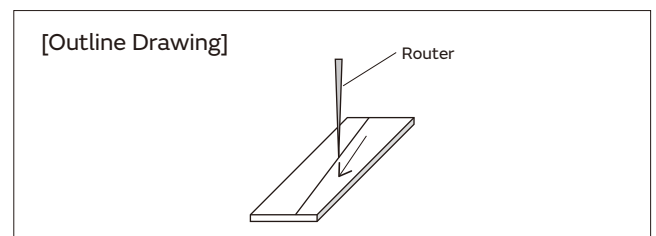

Continued on the following page. ↗

GRT Series  
 GCM Series  
 GC3 Series  
 GCJ Series  
 GCQ Series  
 GCD Series  
 GCE Series  
 NMF Series  
 KCM Series  
 KC3 Series  
 KCA Series  
 GCG Series  
 ⚠Caution

GRT Series  
 GCM Series  
 GC3 Series  
 GCJ Series  
 GCQ Series  
 GCD Series  
 GCE Series  
 NMF Series  
 KCM Series  
 KC3 Series  
 KCA Series  
 GCG Series  
 ⚠Caution

**⚠Caution**

Continued from the preceding page. ↘

**8. Assembly**

**1. Handling**

If a board mounted with capacitors is held with one hand, the board may bend. Firmly hold the edges of the board with both hands when handling.

If a board mounted with capacitors is dropped, cracks may occur in the capacitors.

Do not use dropped boards, as there is a possibility that the quality of the capacitors may be impaired.

**2. Attachment of Other Components**

**2-1. Mounting of Other Components**

Pay attention to the following items, when mounting other components on the back side of the board after capacitors have been mounted on the opposite side. When the bottom dead point of the suction nozzle is set too low, board deflection stress may be applied to the capacitors on the back side (bottom side), and cracks may occur in the capacitors.

- After the board is straightened, set the bottom dead point of the nozzle on the upper surface of the board.
- Periodically check and adjust the bottom dead point.

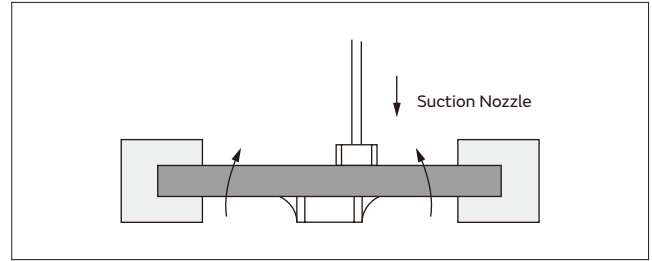

**2-2. Inserting Components with Leads into Boards**

When inserting components (transformers, IC, etc.) into boards, bending the board may cause cracks in the capacitors or cracks in the solder.

Pay attention to the following.

- Increase the size of the holes to insert the leads, to reduce the stress on the board during insertion.
- Fix the board with support pins or a dedicated jig before insertion.
- Support below the board so that the board does not bend. When using support pins on the board, periodically confirm that there is no difference in the height of each support pin.

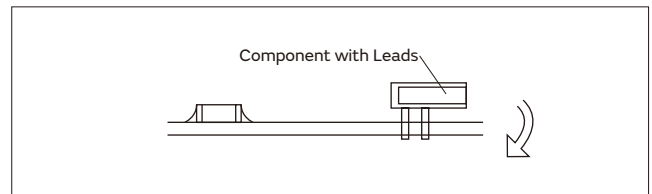

**2-3. Attaching/Removing Sockets and/or Connectors**

Insertion and removal of sockets and connectors, etc., might cause the board to bend. Please insure that the board does not warp during insertion and removal of sockets and connectors, etc., or the bending may damage mounted components on the board.

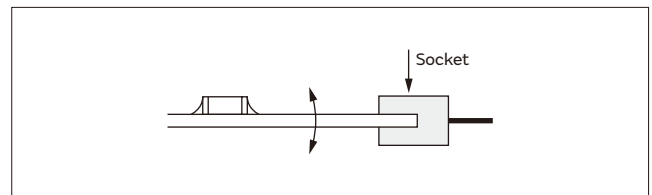

**2-4. Tightening Screws**

The board may be bent, when tightening screws, etc. during the attachment of the board to a shield or chassis.

Pay attention to the following items before performing the work.

- Plan the work to prevent the board from bending.
- Use a torque screwdriver, to prevent over-tightening of the screws.
- The board may bend after mounting by reflow soldering, etc. Please note, as stress may be applied to the chips by forcibly flattening the board when tightening the screws.

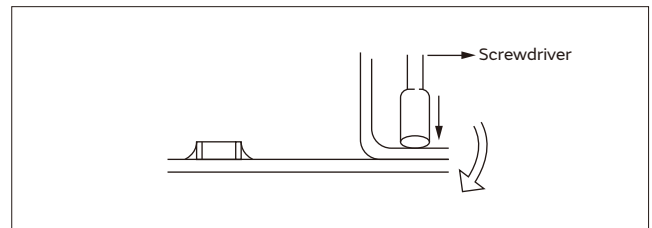

Continued on the following page. ↗



Continued from the preceding page. ↘

<Applicable to GCG Series>

## 9. Selection of Conductive Adhesive, Mounting Process, and Bonding Strength

The acquired bonding strength may change greatly depending on the conductive adhesive to be used.

Be sure to confirm if the desired performance can be acquired in the assumed mounting process with the conductive adhesive to be used.

## Other

### 1. Under Operation of Equipment

- 1-1. Do not touch a capacitor directly with bare hands during operation in order to avoid the danger of an electric shock.
- 1-2. Do not allow the terminals of a capacitor to come in contact with any conductive objects (short-circuit). Do not expose a capacitor to a conductive liquid, including any acid or alkali solutions.
- 1-3. Confirm the environment in which the equipment will operate is under the specified conditions. Do not use the equipment under the following environments.
  - (1) Being splattered with water or oil.
  - (2) Being exposed to direct sunlight.
  - (3) Being exposed to ozone, ultraviolet rays, or radiation.
  - (4) Being exposed to toxic gas (e.g., hydrogen sulfide, sulfur dioxide, chlorine, ammonia gas, etc.)
  - (5) Any vibrations or mechanical shocks exceeding the specified limits.
  - (6) Moisture condensing environments.
- 1-4. Use damp proof countermeasures if using under any conditions that can cause condensation.

### 2. Other

- 2-1. In an Emergency
  - (1) If the equipment should generate smoke, fire, or smell, immediately turn off or unplug the equipment.  
If the equipment is not turned off or unplugged, the hazards may be worsened by supplying continuous power.
  - (2) In this type of situation, do not allow face and hands to come in contact with the capacitor or burns may be caused by the capacitor's high temperature.
- 2-2. Disposal of Waste  
When capacitors are disposed of, they must be burned or buried by an industrial waste vendor with the appropriate licenses.
- 2-3. Circuit Design
  - (1) Addition of Fail Safe Function  
Capacitors that are cracked by dropping or bending of the board may cause deterioration of the insulation resistance, and result in a short.

## 10. Moisture Proof Process

In order to prevent the occurrence of migration, perform a moisture proof process, such as applying a resin coating or enclosing with a dry inert gas.

## 11. Application

This product is limited to conductive glue mounting. When performing solder mounting, contact Murata in advance.

If the circuit being used may cause an electrical shock, smoke or fire when a capacitor is shorted, be sure to install fail-safe functions, such as a fuse, to prevent secondary accidents.

- (2) Capacitors used to prevent electromagnetic interference in the primary AC side circuit, or as a connection/insulation, must be a safety standard certified product, or satisfy the contents stipulated in the Electrical Appliance and Material Safety Law. Install a fuse for each line in case of a short.
- (3) The GC3, GCD, GCE, GCG, GCJ, GCM, KC3, KCM, and NFM series are not safety standard certified products.

### 2-4. Test Condition for AC Withstanding Voltage

- (1) Test Equipment  
Test equipment for AC withstanding voltage should be made with equipment capable of creating a wave similar to a 50/60Hz sine wave.
- (2) Voltage Applied Method

The capacitor's lead or terminal should be firmly connected to the output of the withstanding voltage test equipment, and then the voltage should be raised from near zero to the test voltage.

If the test voltage is applied directly to the capacitor without raising it from near zero, it should be applied with the zero cross. \*At the end of the test time, the test voltage should be reduced to near zero, and then capacitor's lead or terminals should be taken off the output of the withstanding voltage test equipment.

If the test voltage applied directly to the capacitor without raising it from near zero, surge voltage may occur and cause a defect.

\*ZERO CROSS is the point where voltage sine wave passes 0V. - See the figure at right -

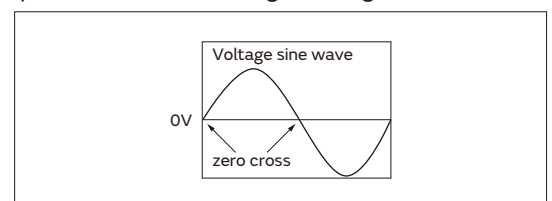

Continued on the following page. ↗

## Notice

Continued from the preceding page. ↘

### 2-5. Remarks

Failure to follow the cautions may result, worst case, in a short circuit and smoking when the product is used.

The above notices are for standard applications and conditions. Contact us when the products are used in special mounting conditions.

Select optimum conditions for operation as they determine the reliability of the product after assembly.

The data herein are given in typical values, not guaranteed ratings.

## Rating

### 1. Operating Temperature

1. The operating temperature limit depends on the capacitor.

1-1. Do not apply temperatures exceeding the upper operating temperature.

It is necessary to select a capacitor with a suitable rated temperature that will cover the operating temperature range.

It is also necessary to consider the temperature distribution in equipment and the seasonal temperature variable factor.

1-2. Consider the self-heating factor of the capacitor.

The surface temperature of the capacitor shall not exceed the maximum operating temperature including self-heating.

1-2. The same phenomenon as the above may occur

when the electrodes or terminals of the capacitor are subject to moisture condensation.

1-3. The deterioration of characteristics and insulation

resistance due to the oxidization or corrosion of terminal electrodes may result in breakdown when the capacitor is exposed to corrosive or volatile gases or solvents for long periods of time.

### 3. Piezo-electric Phenomenon

1. When using high dielectric constant type capacitors in AC or pulse circuits, the capacitor itself vibrates at specific frequencies and noise may be generated.

Moreover, when the mechanical vibration or shock is added to the capacitor, noise may occur.

### 2. Atmosphere Surroundings (gaseous and liquid)

1. Restriction on the operating environment of capacitors.

1-1. Capacitors, when used in the above, unsuitable, operating environments may deteriorate due to the corrosion of the terminations and the penetration of moisture into the capacitor.

## Soldering and Mounting

### 1. PCB Design

1. Notice for Pattern Forms

1-1. Unlike leaded components, chip components are susceptible to flexing stresses since they are mounted directly on the substrate.

They are also more sensitive to mechanical and thermal stresses than leaded components.

Excess solder fillet height can multiply these stresses and cause chip cracking. When designing substrates, take land patterns and dimensions into consideration to eliminate the possibility of excess solder fillet height.

1-2. There is a possibility of chip cracking caused by PCB expansion/contraction with heat, because stress on a chip is different depending on PCB material and structure. When the thermal expansion coefficient greatly differs between the board used for mounting and the chip, it will cause cracking of the chip due to the thermal expansion and contraction. When capacitors are mounted on a fluorine resin printed circuit board or on a single-layered glass epoxy board, it may also cause cracking of the chip for the same reason.

1-3. If you are replacing by smaller capacitors, you should not only consider the Land size change but also consider changing the Wiring Width, Wiring direction, and copper foil thickness because the risk of chip cracking is increased with just a Land size change.

#### <Applicable to NFM Series>

1-4. Because noise is suppressed by shunting unwanted high-frequency components to the ground, when designing a land for the NFM series, design the ground pattern to be as large as possible in order to better bring out this characteristic.



As shown in the figure below, noise countermeasures can be made more effective by using a via to connect the ground pattern on the chip mounting surface to a larger ground pattern on the inner layer.

Continued on the following page. ↗

**Notice**

Continued from the preceding page. ↘

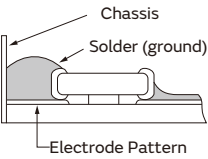
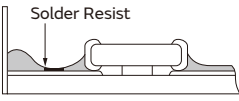
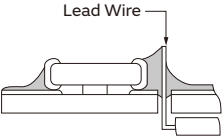
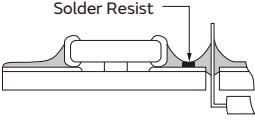
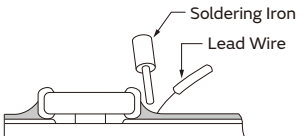
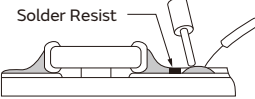
**Pattern Forms**

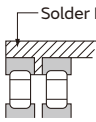
	Prohibited	Correct
Placing Close to Chassis	 in section	 in section
Placing of Chip Components and Leaded Components	 in section	 in section
Placing of Leaded Components after Chip Component	 in section	 in section
Lateral Mounting		

**2. Land Dimensions**

2-1. Please refer to the land dimensions in table 1 for flow soldering, table 2 for reflow soldering.  
 Please confirm the suitable land dimension by evaluating of the actual SET / PCB.

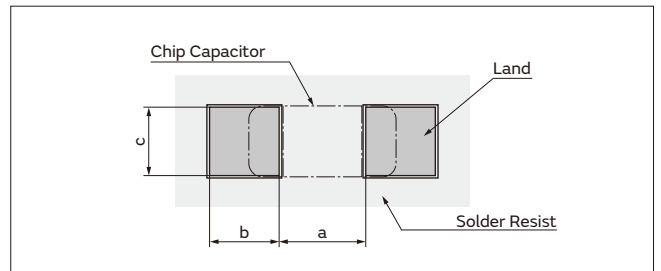

**Table 1 Flow Soldering Method**

Series	Chip Dimension Code (L/W)	Chip (L×W)	a	b	c
GRT/GCM/GC3/GCD/GCJ (Rated Voltage: above 250VDC (for GCJ alone))	18	1.6×0.8	0.6 to 1.0	0.8 to 0.9	0.6 to 0.8
	21	2.0×1.25	1.0 to 1.2	0.9 to 1.0	0.8 to 1.1
	31	3.2×1.6	2.2 to 2.6	1.0 to 1.1	1.0 to 1.4

Flow soldering can only be used for products with a chip size from 1.6×0.8mm to 3.2×1.6mm.

(in mm)

**Table 2 Reflow Soldering Method**

Series	Chip Dimension Code (L/W)	Chip (L×W)	a	b	c
GRT/GCM/GC3/ GCD/GCE/GCJ	03	0.6×0.3	0.2 to 0.3	0.2 to 0.35	0.2 to 0.4
	15	1.0×0.5 (within ±0.10)	0.3 to 0.5	0.35 to 0.45	0.4 to 0.6
		1.0×0.5 (±0.15/±0.20)	0.4 to 0.6	0.4 to 0.5	0.5 to 0.7
	18	1.6×0.8 (within ±0.10)	0.6 to 0.8	0.6 to 0.7	0.6 to 0.8
		1.6×0.8 (±0.15/±0.20)	0.7 to 0.9	0.7 to 0.8	0.8 to 1.0
	21	2.0×1.25 (within ±0.10)	1.2	0.6	1.25
		2.0×1.25 (±0.15)	1.2	0.6 to 0.8	1.2 to 1.4
		2.0×1.25 (±0.20)	1.0 to 1.4	0.6 to 0.8	1.2 to 1.4
	31	3.2×1.6 (within ±0.20)	1.8 to 2.0	0.9 to 1.2	1.5 to 1.7
		3.2×1.6 (±0.30)	1.9 to 2.1	1.0 to 1.3	1.7 to 1.9
	32	3.2×2.5	2.0 to 2.4	1.0 to 1.2	1.8 to 2.3
	43	4.5×3.2	3.0 to 3.5	1.2 to 1.4	2.3 to 3.0
55	5.7×5.0	4.0 to 4.6	1.4 to 1.6	3.5 to 4.8	

(in mm)

Continued on the following page. ↗

## Notice

Continued from the preceding page. ↘

### <Applicable to Part Number KCM/KC3/KCA>

Series	Chip Dimension Code (L×W)	Body Size (L×W)	a	b	c
KCM/KC3 (Except 5C)	55	6.1×5.3	2.6 to 3.2	2.4 to 2.7	5.5 to 5.6
KCM (5C only)	55	6.1×5.1	3.2 to 4.0	2.0 to 2.4	5.5 to 5.7
KCA	55	6.1×5.1	3.2 to 4.0	2.0 to 2.4	5.5 to 5.7

(in mm)

### <Applicable to beyond Rated Voltage of 200VDC>

#### 2-2. Dimensions of Slit (Example)

Preparing the slit helps flux cleaning and resin coating on the back of the capacitor.

However, the length of the slit design should be as short as possible to prevent mechanical damage in the capacitor.

A longer slit design might receive more severe mechanical stress from the PCB.

Recommended slit design is shown in the Table.

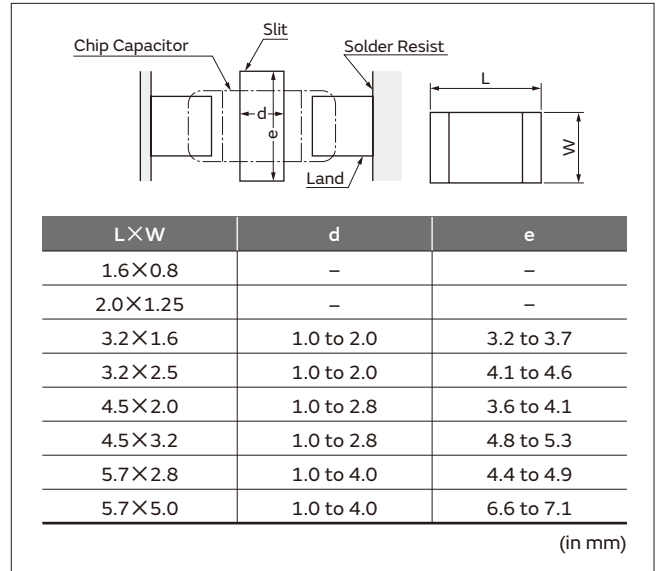

### <Applicable to NFM Series>

Legend: Land Pattern + Solder Resist, Land Pattern, Solder Resist (in mm)

Series	Land Dimensions
NFM21HC	<p>● Reflow Soldering</p> <div style="display: flex; justify-content: space-around;"> <div style="text-align: center;"> <p>NFM18HC</p> <p>Small diameter thru hole <math>\phi 0.2\text{-}\phi 0.3</math></p> </div> <div style="text-align: center;"> <p>NFM21HC</p> <p>Small diameter thru hole <math>\phi 0.4</math></p> </div> </div>
	<div style="display: flex; justify-content: space-between;"> <div style="width: 45%;"> <p>● Reflow Soldering Chip mounting side</p> <p>NFM31HK*1</p> <p>Small diameter thru hole <math>\phi 0.4</math></p> <p>10mm or more (in case of 10A)</p> </div> <div style="width: 45%;"> <p>● Flow Soldering Chip mounting side</p> <p>NFM31HK*1</p> <p>Small diameter thru hole <math>\phi 0.4</math></p> <p>10mm or more (in case of 10A)</p> </div> </div> <p>*1 For large current design, width of signal land pattern should be wider not less than 1mm per 1A (1mm/A). For example, in case of 10A, signal land pattern width should be 10mm or more. (1mm/A*10A=10mm)</p>

Continued on the following page. ↗



Notice

Continued from the preceding page. ↘

3. Board Design

When designing the board, keep in mind that the amount of strain which occurs will increase depending on the size and material of the board.

[Relationship with amount of strain to the board thickness, length, width, etc.]

$$\epsilon = \frac{3PL}{2Ewh^2}$$

Relationship between load and strain

- ε: Strain on center of board (μst)
- L: Distance between supporting points (mm)
- w: Board width (mm)
- h: Board thickness (mm)
- E: Elastic modulus of board (N/m<sup>2</sup>=Pa)
- Y: Deflection (mm)
- P: Load (N)

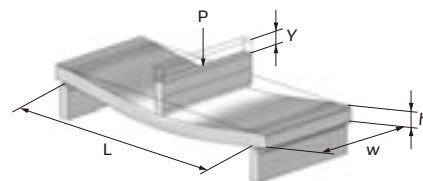

- When the load is constant, the following relationship can be established.
- As the distance between the supporting points (L) increases, the amount of strain also increases.  
→Reduce the distance between the supporting points.
  - As the elastic modulus (E) decreases, the amount of strain increases.  
→Increase the elastic modulus.
  - As the board width (w) decreases, the amount of strain increases.  
→Increase the width of the board.
  - As the board thickness (h) decreases, the amount of strain increases.  
→Increase the thickness of the board.  
Since the board thickness is squared, the effect on the amount of strain becomes even greater.

2. Item to be confirmed for Flow soldering

If you want to temporarily attach the capacitor to the board using an adhesive agent before soldering the capacitor, first be sure that the conditions are appropriate for affixing the capacitor. If the dimensions of the land, the type of adhesive, the amount of coating, the contact surface area, the curing temperature, or other conditions are inappropriate, the characteristics of the capacitor may deteriorate.

1. Selection of Adhesive

- 1-1. Depending on the type of adhesive, there may be a decrease in insulation resistance. In addition, there is a chance that the capacitor might crack from contractile stress due to the difference in the contraction rate of the capacitor and the adhesive.
- 1-2. If there is not enough adhesive, the contact surface area is too small, or the curing temperature or curing time are inadequate, the adhesive strength will be insufficient and the capacitor may loosen or become disconnected during transportation or soldering. If there is too much adhesive, for example if it overflows onto the land, the result could be soldering defects, loss of electrical connection, insufficient curing, or slippage after the capacitor is mounted. Furthermore, if the curing temperature is too high or the curing time is too long, not only will the adhesive

strength be reduced, but solderability may also suffer due to the effects of oxidation on the terminations (outer electrodes) of the capacitor and the land surface on the board.

(1) Selection of Adhesive

Epoxy resins are a typical class of adhesive.

To select the proper adhesive, consider the following points.

- 1) There must be enough adhesive strength to prevent the component from loosening or slipping during the mounting process.
- 2) The adhesive strength must not decrease when exposed to moisture during soldering.
- 3) The adhesive must have good coatability and shape retention properties.
- 4) The adhesive must have a long pot life.
- 5) The curing time must be short.
- 6) The adhesive must not be corrosive to the exterior of the capacitor or the board.
- 7) The adhesive must have good insulation properties.
- 8) The adhesive must not emit toxic gases or otherwise be harmful to health.
- 9) The adhesive must be free of halogenated compounds.

Continued on the following page. ↗

GRT Series  
 GCM Series  
 GC3 Series  
 GCJ Series  
 GCQ Series  
 GCD Series  
 GCE Series  
 NMF Series  
 KCM Series  
 KC3 Series  
 KCA Series  
 GCG Series  
 Notice

## Notice

Continued from the preceding page. ↘

(2) Use the following illustration as a guide to the amount of adhesive to apply.

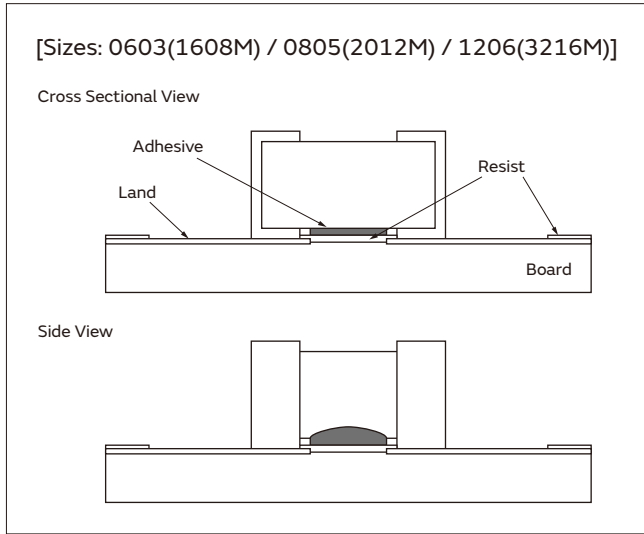

<Applicable to NFM Series>

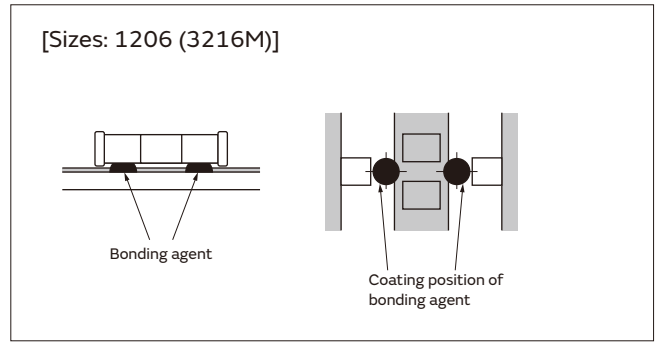

### 2. Flux

- 2-1. An excessive amount of flux generates a large quantity of flux gas, which can cause a deterioration of solderability, so apply flux thinly and evenly throughout. (A foaming system is generally used for flow soldering.)
- 2-2. Flux containing too high a percentage of halide may cause corrosion of the terminations unless there is sufficient cleaning. Use flux with a halide content of 0.1% max.
- 2-3. Strong acidic flux can corrode the capacitor and degrade its performance.  
 Please check the quality of capacitor after mounting.

### 3. Leaching of the terminations

- Set temperature and time to ensure that leaching of the termination does not exceed 25% of the chip end area as a single chip (full length of the edge A-B-C-D shown at right) and 25% of the length A-B shown as mounted on substrate.

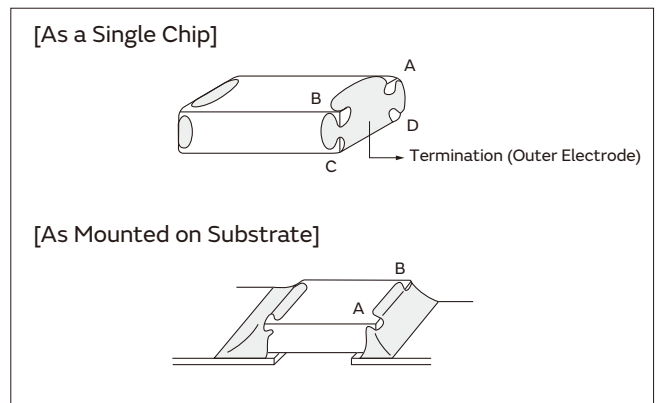

### 3. Reflow Soldering

The flux in the solder paste contains halogen-based substances and organic acids as activators. Strong acidic flux can corrode the capacitor and degrade its performance.  
 Please check the quality of capacitor after mounting.

Continued on the following page. ↗

## Notice

Continued from the preceding page. ↘

### 4. Washing

1. Please evaluate the capacitor using actual cleaning equipment and conditions to confirm the quality, and select the solvent for cleaning.

### 5. Coating

1. A crack may be caused in the capacitor due to the stress of the thermal contraction of the resin during curing process.  
The stress is affected by the amount of resin and curing contraction.  
Select a resin with low curing contraction.  
The difference in the thermal expansion coefficient between a coating resin or a molding resin and the capacitor may cause the destruction and deterioration of the capacitor such as a crack or peeling, and lead to the deterioration of insulation resistance or dielectric breakdown.  
Select a resin for which the thermal expansion coefficient is as close to that of the capacitor as possible.  
A silicone resin can be used as an under-coating to buffer against the stress.

### Other

#### 1. Transportation

1. The performance of a capacitor may be affected by the conditions during transportation.
  - 1-1. The capacitors shall be protected against excessive temperature, humidity, and mechanical force during transportation.
    - (1) Climatic condition
      - low air temperature: -40°C
      - change of temperature air/air: -25°C/+25°C
      - low air pressure: 30 kPa
      - change of air pressure: 6 kPa/min.
    - (2) Mechanical condition  
Transportation shall be done in such a way that the boxes are not deformed and forces are not directly passed on to the inner packaging.
  - 1-2. Do not apply excessive vibration, shock, or pressure to the capacitor.
    - (1) When excessive mechanical shock or pressure is applied to a capacitor, chipping or cracking may occur in the ceramic body of the capacitor.
    - (2) When the sharp edge of an air driver, a soldering iron, tweezers, a chassis, etc. impacts strongly on the surface of the capacitor, the capacitor may crack and short-circuit.
  - 1-3. Do not use a capacitor to which excessive shock was applied by dropping, etc.  
A capacitor dropped accidentally during processing may be damaged.

2. Unsuitable cleaning may leave residual flux or other foreign substances, causing deterioration of electrical characteristics and the reliability of the capacitors.
  2. Select a resin that is less hygroscopic.  
Using hygroscopic resins under high humidity conditions may cause the deterioration of the insulation resistance of a capacitor.  
An epoxy resin can be used as a less hygroscopic resin.
  3. The halogen system substance and organic acid are included in coating material, and a chip corrodes by the kind of Coating material.  
Do not use strong acid type.

#### 2. Characteristics Evaluation in the Actual System

1. Evaluate the capacitor in the actual system, to confirm that there is no problem with the performance and specification values in a finished product before using.
2. Since a voltage dependency and temperature dependency exists in the capacitance of high dielectric type ceramic capacitors, the capacitance may change depending on the operating conditions in the actual system. Therefore, be sure to evaluate the various characteristics, such as the leakage current and noise absorptivity, which will affect the capacitance value of the capacitor.
3. In addition, voltages exceeding the predetermined surge may be applied to the capacitor by the inductance in the actual system. Evaluate the surge resistance in the actual system as required.

#### <Applicable to NFM Series>

4. The effects of noise suppression can vary depending on the usage conditions, including differences in the circuit or IC to be used, the type of noise, the shape of the pattern to be mounted, and the mounting location. Be sure to verify the effect on the actual device in advance.

GRT Series

GCM Series

GC3 Series

GCJ Series

GCQ Series

GCD Series

GCE Series

NMF Series

KCM Series

KC3 Series

KCA Series

GCG Series

Notice



# Design Support Tool "SimSurfing"

<https://www.murata.com/simsurfing/>

This is the latest tool to get the electrical characteristics for Capacitors, Inductors, and EMI Suppression Filters, and to simulate Thermistors' behavior !



**■ Characteristics viewer**  
 You can easily search and download the following data for Multilayer Ceramic Capacitors, Polymer Capacitors, EMI Suppression Filters (Three-terminal Capacitors, Ferrite Beads) and Power/RF Inductors.

**■ Components performance simulator**  
 You can search by the simulation on simple circuits for Thermistors.

**■ Selection tool**  
 You can select Medium voltage Capacitors and Power Inductors according to conditions of use.  
 \* Medium voltage: Rated Voltage 250V and over

**■ Search tool**  
 You can search the Murata timing device (CERALOCK® and crystal units) that is most suitable for your IC and access information about the recommended circuit constant setting.

If you register as a "my Murata" user (<https://my.murata.com/en/web/mymurata/>), you can use Enhanced SimSurfing.

## ■ Usage example of "Multilayer Ceramic Capacitors"

### 1 Select the products

- (1) By performance/type
- (2) By part number

### 2 Show graph

Click each button on each tab of [Basic], [S-parameter] and [Detailed].

### 3 Data download

- Click each purple button in this area.
- Click "CSV output" button.

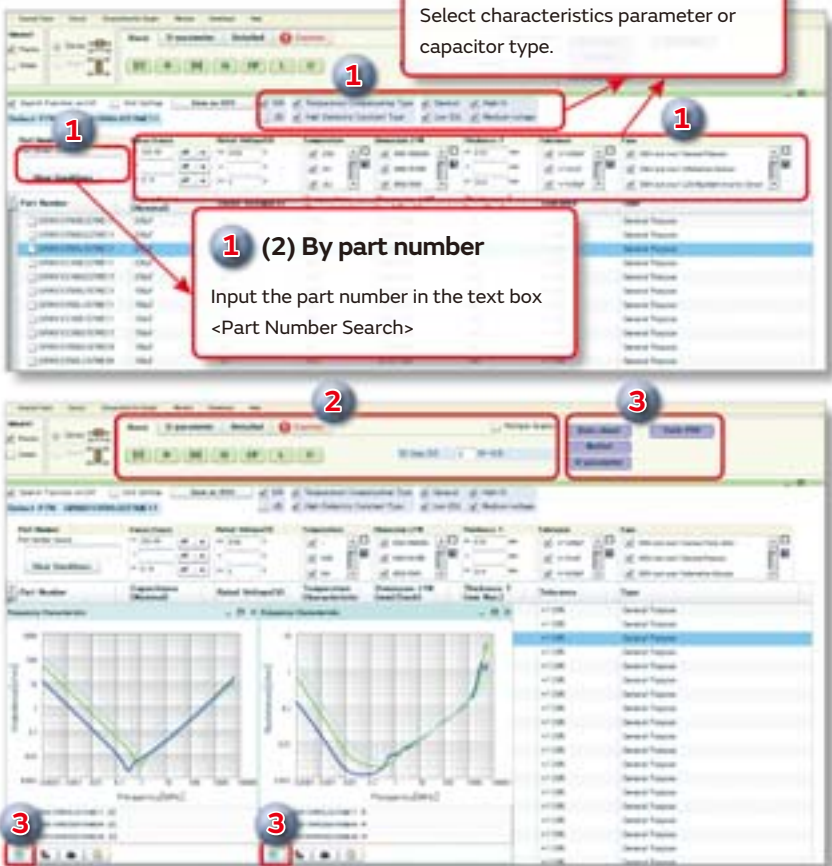

**1 (1) By performance/type**  
 Select characteristics parameter or capacitor type.

**1 (2) By part number**  
 Input the part number in the text box <Part Number Search>

**2**  
 Click each button on each tab of [Basic], [S-parameter] and [Detailed].

**3**  
 Click each purple button in this area. Click "CSV output" button.

\* Images are as of October 2015. Be assured that this software will be updated frequently.

<https://www.murata.com/simsurfing/>

# Web page Introduction

**muRata** Product Search



## 1 Search by Part Number <https://psearch.en.murata.com/capacitor/partnumber/>



You can search for capacitors by specifying the alphanumeric characters in the part number. The packing codes shown contain the substitute character "#". If you enter the official packing code, part numbers that contain that packing code will be matched.

## 2 Search by Specifications <https://psearch.en.murata.com/capacitor/spec/smd/>



You can search for SMD, lead type, or screw termination type capacitors by indicating specifications such as application, capacitance, rated voltage, or temperature characteristics.

You can narrow your search by entering values of ranges, and by specifying product characteristics.

The items for narrowing searches are linked, so specifying one condition causes selectable options for the other items to allow input only of conditions that match the relevant part numbers.



### Search in the Lineups <https://psearch.en.murata.com/capacitor/lineup/>

You can search for capacitors by specifying the series lineup.

You can also confirm items such as characteristics and applications on each series page.

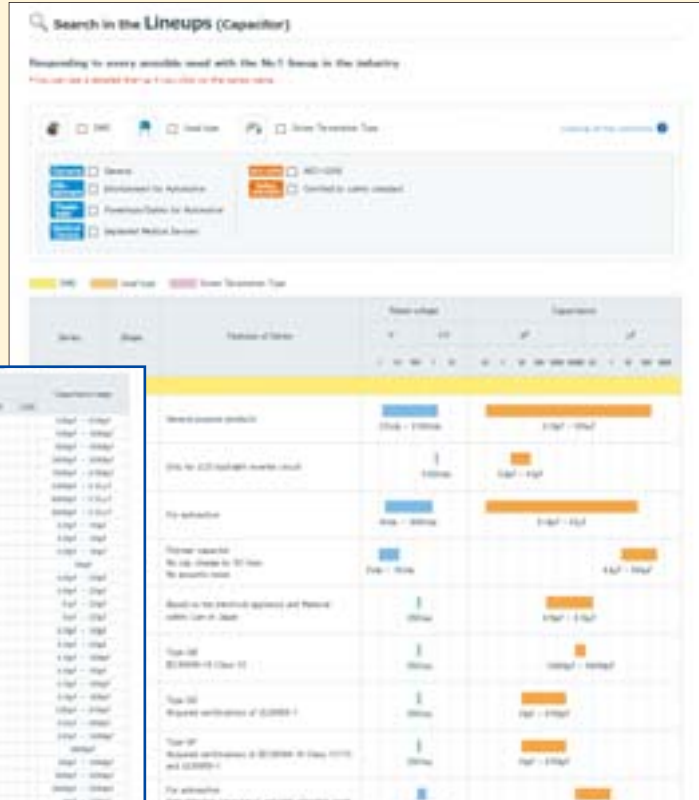

Capacitance chart in Series page.

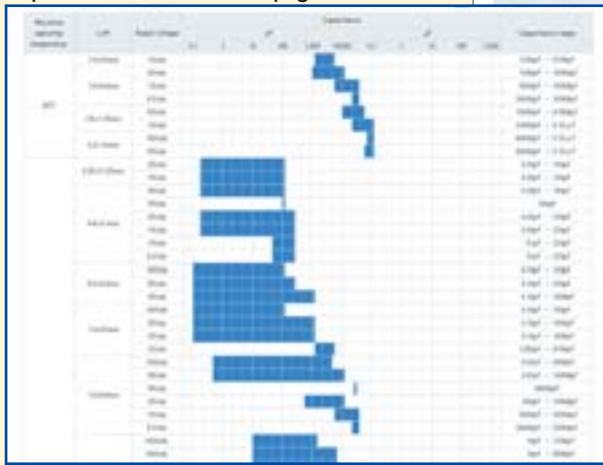

### [Search result]

Compares the characteristics of the checked  part numbers.

Displays the number of hits for the current search conditions in real time.

Clicking on each search condition button brings up a menu, allowing you to narrow the search results to match the selected condition in real time.

Click "Current search terms" to display a menu, from which you can confirm the current conditions for narrowing the search results.

Click the ▲ mark for each item to switch between ascending and descending display.

Click a product name to display a details page listing more in-depth information (→ P22).

You can download detailed spec sheets.

Icons enable you to check the status and characteristics of products at a glance.

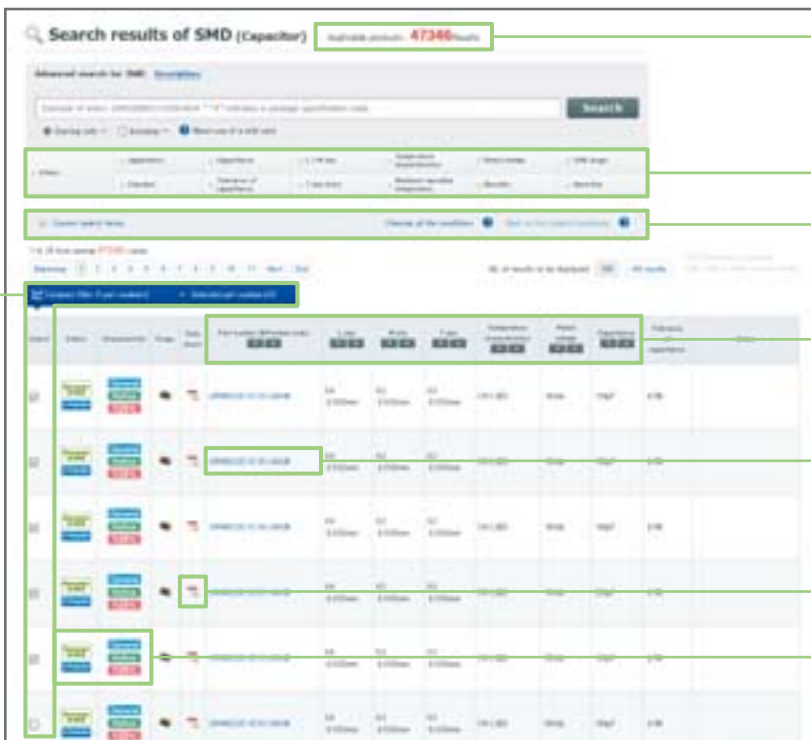

# Global Locations

For details please visit [www.murata.com](http://www.murata.com)



## ⚠ Note

### 1 Export Control

*For customers outside Japan:*

No Murata products should be used or sold, through any channels, for use in the design, development, production, utilization, maintenance or operation of, or otherwise contribution to (1) any weapons (Weapons of Mass Destruction [nuclear, chemical or biological weapons or missiles] or conventional weapons) or (2) goods or systems specially designed or intended for military end-use or utilization by military end-users.

*For customers in Japan:*

For products which are controlled items subject to the "Foreign Exchange and Foreign Trade Law" of Japan, the export license specified by the law is required for export.

2 Please contact our sales representatives or product engineers before using the products in this catalog for the applications listed below, which require especially high reliability for the prevention of defects which might directly damage a third party's life, body or property, or when one of our products is intended for use in applications other than those specified in this catalog.

- ① Aircraft equipment
- ② Aerospace equipment
- ③ Undersea equipment
- ④ Power plant equipment
- ⑤ Medical equipment
- ⑥ Transportation equipment (vehicles, trains, ships, etc.)
- ⑦ Traffic signal equipment
- ⑧ Disaster prevention / crime prevention equipment
- ⑨ Data-processing equipment
- ⑩ Application of similar complexity and/or reliability requirements to the applications listed above

3 Product specifications in this catalog are as of October 2019. They are subject to change or our products in it may be discontinued without advance notice. Please check with our sales representatives or product engineers before ordering. If there are any questions, please contact our sales representatives or product engineers.

4 Please read rating and ⚠CAUTION (for storage, operating, rating, soldering, mounting and handling) in this catalog to prevent smoking and/or burning, etc.

5 This catalog has only typical specifications. Therefore, please approve our product specifications or transact the approval sheet for product specifications before ordering.

6 Please note that unless otherwise specified, we shall assume no responsibility whatsoever for any conflict or dispute that may occur in connection with the effect of our and/or a third party's intellectual property rights and other related rights in consideration of your use of our products and/or information described or contained in our catalogs. In this connection, no representation shall be made to the effect that any third parties are authorized to use the rights mentioned above under licenses without our consent.

7 No ozone depleting substances (ODS) under the Montreal Protocol are used in our manufacturing process.

Murata Manufacturing Co., Ltd.

[www.murata.com](http://www.murata.com)

**muRata**  
INNOVATOR IN ELECTRONICS