

MLX90393 Triaxis® Magnetic Node

Datasheet

1. Features and Benefits

- Absolute Position Sensor IC featuring Triaxis® Hall Technology
- Simple & Robust Magnetic Design
- Miniature size for tiny assemblies
- Selectable SPI and I²C bus protocols
- Wide dynamic range (5-50mT) with on-the-fly programmable gain
- 2.2V-3.6V supply for battery powered applications, down to 1.8V IO voltage
- On board filter settings
- On the fly programmable operating modes and sleep times for micro-power use
- External and internal acquisition triggering modes
- External interrupt pin when the field changes
- On board temperature sensor

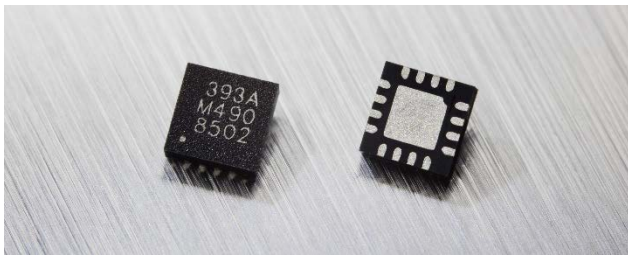

2. Application Examples

- Non-contacting HMI applications with push-pull functionality
 - Rotary knobs & dials
 - (Long stroke) Linear motion in one or two axes for levers & sliding switches
 - Joystick (gimbal or ball & socket)
- Home Security 3D closure detection
- Accurate liquid level sensing
- Factory automation position sensing
- Magnetic fingerprint detection

3. Description

The MLX90393 brings the highest flexibility in the Triaxis portfolio's smallest packaged assembly. Additionally, the MLX90393 is designed for micropower applications, with programmable duty cycles in the range of 0.1% to 100% allowing for configurable power consumption based on system requirements.

The MLX90393 magnetic field sensor can be reprogrammed to different modes and with different settings at run-time to fine-tune the performance and power consumed. The sensor offers a 16-bit output proportional to the magnetic flux density sensed along the X, Y, and Z axes using the Melexis proprietary Triaxis technology and offers a 16-bit temperature output signal. These digital values are available via I²C and SPI, where the MLX90393 is a slave on the bus. Multiple sensors can be connected to the same bus, by A₀ and A₁ hardwired connection (4x) but also through ordering codes with different SW address (4x).

By selecting which axes are to be measured, the raw data can be used as input for further post-processing, such as for joystick applications, rotary knobs, and more complex 3D position sensing applications. Unparalleled performance is achieved with this sensor, which is primarily targeting industrial and consumer applications.

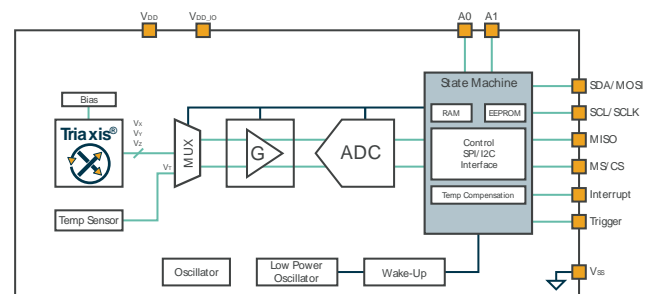

Figure 1: General Block Diagram

Contents

1. Features and Benefits	1
2. Application Examples	1
3. Description	1
4. Ordering Information	5
5. Functional Diagram	6
5.1. QFN-16 Block Diagram	6
5.2. UTDFN-8 Block Diagram.....	6
6. Glossary of Terms	7
7. QFN-16 Pinout	8
8. UTDFN-8 Pinout	9
9. Absolute Maximum Ratings	10
10. General Electrical Specifications	11
11. Thermal Specification	12
12. Timing Specification	13
13. Magnetic Specification	14
13.1. Noise vs Conversion Time	16
14. Mode Selection	17
14.1. Burst mode.....	18
14.2. Single Measurement mode	18
14.3. Wake-Up on Change mode.....	19
15. Digital Specification	19
15.1. Command List	20
15.2. Status Byte	21
15.3. SPI Communication.....	22
15.3.1. Command implementation.....	22
15.3.2. SPI Timing Specification	24
15.4. I ² C Communication	24
15.4.1. Command Implementation.....	25
15.4.2. I ² C Timing Specification	27
16. Memory Map	28
16.1. General Description	28

16.2. Parameter Description.....	30
16.2.1. ANA_RESERVED_LOW.....	31
16.2.2. BIST.....	31
16.2.3. Z_Series.....	31
16.2.4. GAIN_SEL[2:0].....	32
16.2.5. HALLCONF[3:0].....	33
16.2.6. TRIG_INT_SEL.....	33
16.2.7. COMM_MODE[1:0].....	33
16.2.8. WOC_DIFF.....	33
16.2.9. EXT_TRIG.....	34
16.2.10. TCMP_EN.....	34
16.2.11. BURST_SEL[3:0].....	34
16.2.12. OSR2[1:0].....	34
16.2.13. RES_XYZ[5:0].....	34
16.2.14. DIG_FILT[1:0].....	34
16.2.15. OSR[1:0].....	34
16.2.16. SENS_TC_HT[7:0].....	34
16.2.17. SENS_TC_LT[7:0].....	35
16.2.18. OFFSET_i[15:0].....	35
16.2.19. WO _i _THRESHOLD[15:0].....	35
17. Recommended Application Diagram.....	36
1.1 I ² C.....	36
1.2 SPI.....	36
18. Packaging Specification.....	37
18.1. QFN-16.....	37
18.1.1. Package dimensions and sensitive spot location.....	37
18.1.2. QFN-16 - Pinout and Marking.....	38
18.2. UDFN-8 package.....	39
18.2.1. Package dimensions and sensitive spot location.....	39
18.2.2. UDFN-8 - Pinout and Marking.....	40
19. Standard Information.....	40
20. ESD Precautions.....	40
21. Revision History.....	41

22. Contact 42

23. Disclaimer 43

4. Ordering Information

Product	Temperature	Package	Option Code	Packing Form	Definition
MLX90393	S (-20°C to 85°C)	LW	ABA-011	RE	I ² C address = 00011xx
MLX90393	S (-20°C to 85°C)	LW	ABA-012	RE	I ² C address = 00100xx
MLX90393	S (-20°C to 85°C)	LW	ABA-013	RE	I ² C address = 00101xx
MLX90393	S (-20°C to 85°C)	LW	ABA-014	RE	I ² C address = 00110xx
MLX90393	E (-40°C to 85°C)	LW	ABA-011	RE	I ² C address = 00011xx
MLX90393	E (-40°C to 85°C)	LW	ABA-012	RE	I ² C address = 00100xx
MLX90393	E (-40°C to 85°C)	LW	ABA-013	RE	I ² C address = 00101xx
MLX90393	E (-40°C to 85°C)	LW	ABA-014	RE	I ² C address = 00110xx
MLX90393	S (-20°C to 85°C)	LQ	ABA-011	RE	I ² C address = 0010000

Table 1: Product Ordering Codes

Legend:

Temperature Code:	S: from -20°C to 85°C E: from -40°C to 85°C
Package Code:	“LW” for QFN-16 3x3x1mm package with wettable flanks “LQ” for UTDFN-8 2.5x2mm package
Option Code:	ABA-011: ABA-012: ABA-013: ABA-014: Different I ² C addresses – 5 most significant bits. The 2 least significant bits of the address are defined by the external address pins A ₀ and A ₁ .
Packing Form:	“RE for Reel”
Ordering Example:	“MLX90393-ELW-ABA-011-RE” MLX90393 Micropower magnetometer with I ² C address 00011xx where the last two bits are defined by external address pins A ₀ and A ₁ . In QFN package, temperature range -40°C to 85°C.

Table 2: Product Ordering Code Example

5. Functional Diagram

5.1. QFN-16 Block Diagram

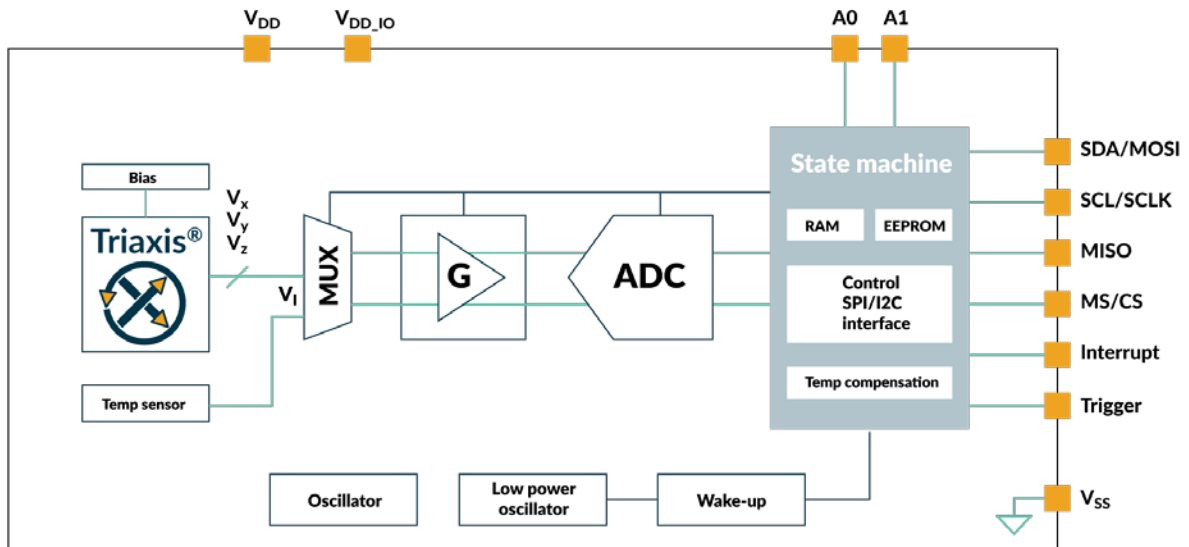

5.2. UTDFN-8 Block Diagram

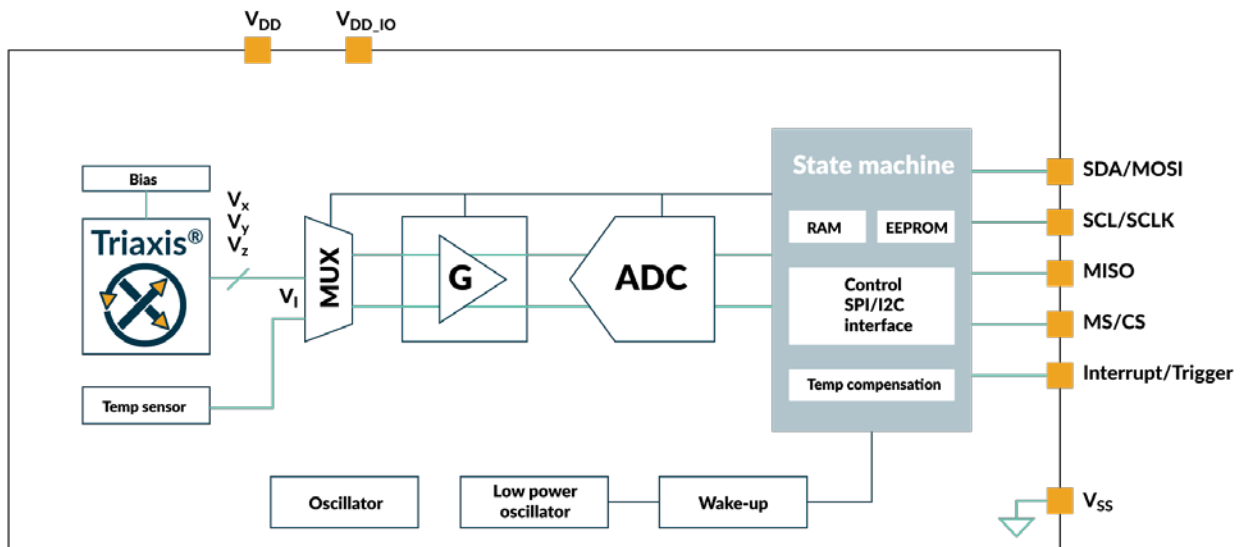

6. Glossary of Terms

Term	Definition
TC	Temperature Coefficient (in ppm/°C)
Gauss (G), Tesla (T)	Units for the magnetic flux density – 1 mT = 10 G
NC	Not Connected
PWM	Pulse Width Modulation
%DC	Duty Cycle of the output signal i.e. $T_{ON} / (T_{ON} + T_{OFF})$
ADC	Analog-to-Digital Converter
DAC	Digital-to-Analog Converter
LSb	Least Significant Bit
MSb	Most Significant Bit
DNL	Differential Non-Linearity
INL	Integral Non-Linearity
EMC	Electro-Magnetic Compatibility

7. QFN-16 Pinout

Pin #	Name	Type		Supply System	Wiring Recommendation		
		Primary	Secondary	Reference To	I ² C	4-wire SPI	3-wire SPI
1	INT	I/O out	N/A	VDD_IO	Optional	Optional	Optional
2	SENB/CS	I/O in	MLX Test	VDD_IO	To VDD_IO	Required	Required
3	SCL/SCLK	I/O in	MLX Test	VDD_IO	Required	Required	Required
4	N/C	--	--	--	--	--	--
5	SDA/MOSI	I/O bi	MLX Test	VDD_IO	Required	Required	Short together
6	MISO	I/O out	MLX Test	VDD_IO	Floating	Required	
7	INT/TRIG	I/O bi	N/A	VDD_IO	Optional	Optional	Optional
8	VDD_IO	Supply	N/A		Required	Required	Required
9	N/C	--	--	--	--	--	--
10	N/C	--	--	--	--	--	--
11	A1	I ² C Address LSB	MLX Test	VDD	To VDD/GND	To GND	To GND
12	A0	I ² C Address LSB	MLX Test	VDD	To VDD/GND	To GND	To GND
13	VSS	Ground	N/A		Required	Required	Required
14	N/C	--	--	--	--	--	--
15	VDD	Supply	N/A		Required	Required	Required
16	N/C	--	--	--	--	--	--

Table 3: Pinout Description

It is recommended to connect the N/C pins (Not Connected) to Ground.

8. UTDFN-8 Pinout

Pin #	Name	Type		Supply System	Wiring Recommendation		
		Primary	Secondary	Reference To	I ² C	4-wire SPI	3-wire SPI
1	SCL/SCLK	I/O in	MLX Test	VDD_IO	Required	Required	Required
2	SDA/MOSI	I/O bi	MLX Test	VDD_IO	Required	Required	Short together
3	MISO	I/O out	MLX Test	VDD_IO	Floating	Required	
4	VDD_IO	Supply	N/A		Required	Required	Required
5	VSS	Ground	N/A		Required	Required	Required
6	VDD	Supply	N/A		Required	Required	Required
7	SENB/CS	I/O in	MLX Test	VDD_IO	To VDD_IO	Required	Required
8	INT	I/O out	N/A	VDD_IO	Optional	Optional	Optional

Table 4: UTDFN-8 Pinout Description

9. Absolute Maximum Ratings

Parameter	Symbol	Min.	Typ.	Max.	Unit
V_{DD_MAX}	Analog Supply Voltage Limits	-0.3		4	V
$V_{DD_IO_MAX}$	Digital IO Supply Limits	-0.3		$\min(4, V_{DD}+0.3)$	V
$T_{STORAGE}$	Storage (idle) temperature range	-50		125	°C
ESD_{HBM}	According to AEC-Q100-002			2.5	kV
ESD_{CDM}	According to AEC-Q100-011-B (QFN)			750	V

Table 5: Absolute Maximum Ratings

Exceeding the absolute maximum ratings may cause permanent damage. Exposure to absolute maximum-rated conditions for extended periods may affect device reliability.

10. General Electrical Specifications

Parameter	Remark	Min	Nom	Max	Unit
V _{DD}	Analog Supply Voltage	2.2	3	3.6	V
V _{DD_IO}	Digital IO Supply	1.65	1.8	V _{DD}	V
V _{POR_LH}	Power-on Reset threshold (rising edge)		1.42	1.55	V
V _{POR_HL}	Power-on Reset threshold (falling edge)	1	1.31		V
I _{DD,CONVXY}	Conversion Current XY-axis		2.29	3	mA
I _{DD,CONVZ}	Conversion Current Z-axis		2.96	4	mA
I _{DD,CONVT}	Conversion Current Temperature		1.60	2	mA
I _{DD, CONV_END}	Current during T _{CONV_END}		1.5	1.75	mA
I _{DD_ACTIVE}	Current during T _{ACTIVE}		1.2	1.75	mA
I _{DD_IDLEtoSTBY}	Current during T _{STBY}		1.2	1.75	mA
I _{DD,STBY}	Standby Current ⁽¹⁾		43	60	μA
I _{DD,IDLE}	Idle Current ⁽²⁾	1	2.4	5	μA
I _{DD,NOM}	Nominal Current (TXYZ, Datarate = 10Hz, OSR=OSR2=0, DIG_FILT=4)		100		μA

Table 6: General Electrical Specifications

¹ Standby current corresponds to the current consumed in the digital where only the low power oscillator is running. This standby current is present in burst mode, or whenever the IC is counting down to start a new conversion.

² Idle current corresponds to the current drawn by the IC in idle mode where all operating functions are disabled except communications.

11. Thermal Specification

The MLX90393 has an on-board temperature sensor which measures the temperature of the MLX90393 sensor. The temperature can be read out via the communication protocol in a digital format

Parameter	Symbol	Min.	Typ.	Max.	Unit
T _{RES}	Temperature sensor resolution		45.2		LSB/°C
T ₂₅	Temperature sensor output at 25°C		46244		LSB _{16u}
T _{LIN}	Temperature Linearity ⁽³⁾		+/-3		°C
T _{OPERATING}	Operating temperature range [S code]	-20	25	85	°C
	Operating temperature range [E code]	-40	25	85	°C

Table 7: Thermal Specifications

³ The linearity is defined as the best fit curve through the digital temperature outputs over the entire temperature range. It includes ADC non-linearity effects

12. Timing Specification

The specifications are applicable at 25 Deg. C unless specified otherwise and for the complete supply range.

Parameter	Remark	Min	Nom	Max	Unit
Main Oscillator & Derived Timings					
T_{STBY}	Time from IDLE to STBY	176	220	264	μ s
T_{ACTIVE}	Time from STBY to ACTIVE	288	360	432	μ s
T_{CONVM}	Single Magnetic axis conversion time ⁽⁴⁾ typical programming range	259		66627	μ s
		$67 + 64 \cdot 2^{OSR} \cdot (2 + 2^{DIG_FILT})$			
T_{CONVT}	Temperature conversion time typical programming range	259		1603	μ s
		$67 + 192 \cdot 2^{OSR2}$			
T_{CONV_END}	Time to end analog active mode	80	100	120	μ s
T_{CONV_SMM}	Total conversion time in Single Measurement Mode	$T_{STBY} + T_{ACTIVE} + m \cdot T_{CONVM} + T_{CONVT} + T_{CONV_END}$			ms
$T_{CONV_BURST_NDLY}$	Total conversion time in BURST with burst data rate = 0	$m \cdot T_{CONVM} + T_{CONVT} + T_{CONV_END}$			ms
$T_{CONV_BURST_DLY}$	Total conversion time in BURST with burst data rate > 0	$T_{ACTIVE} + m \cdot T_{CONVM} + T_{CONVT} + T_{CONV_END}$			ms
$T_{CONV_WOC_NDLY}$	Total conversion time in WOC with burst data rate = 0	$m \cdot T_{CONVM} + T_{CONVT} + T_{CONV_END}$			ms
$T_{CONV_WOC_DLY}$	Total conversion time in WOC with burst data rate > 0	$T_{STBY} + T_{ACTIVE} + m \cdot T_{CONVM} + T_{CONVT} + T_{CONV_END}$			ms
T_{OSC_TRIM}	Trimming accuracy	-5		+5	%
T_{OSC_THD}	Thermal drift (full temperature range)	-5		+5	%
Low-power Oscillator & Derived Timings					
$T_{INTERVAL}$	Time in between 2 conversions (Burst mode or Wake-Up on Change) ⁽⁵⁾	0		1260	ms
		$BURST_DATA_RATE \cdot 20$			
T_{LPOSC_TRIM}	Trimming accuracy	-4		+4	%

⁴ This conversion time is defined as the time to acquire a single axis of the magnetic flux density. When measuring multiple axes they are obtained through time multiplexing. The conversion time is programmable through parameters OSR and DIG_FILT for magnetic values and OSR2 for the temperature value. The conversion sequence is TXYZ, opposite of the ZYXT argument of the command set.

⁵ The time $T_{INTERVAL}$ is defined as the time between the end of one set of measurements (any combination of TXYZ) and the start of the following same set of measurements in BURST and WOC mode. As a result of this, the maximum output data rate is not only a function of $T_{INTERVAL}$ but equals $1/(T_{CONV_BURSTWOC} + T_{INTERVAL})$.

Parameter	Remark	Min	Nom	Max	Unit
T _{LPOSC_THD}	Thermal drift (full temperature range)	-5		+5	%
Startup					
T _{POR}	Power-on-reset completion time		0.6	1.5	ms
External Trigger					
T _{TRIG}	Trigger pulse width (active high)	0.01		250	us

Table 8: Timing Specifications

13. Magnetic Specification

The specifications are applicable at 25 Deg. C unless otherwise specified and for the complete supply voltage range.

Parameter	Remark	Min	Nom	Max	Unit
N _{ADC}	ADC span		17.4		bits
N _{OUT}	Output span (taken from 19 by RES _{XYZ})		16		bits
B _{RANGE}	Output range (function of RES _{XYZ})		RANGE from Table 17: Sensitivity table for given gain and resolution selection for HALLCONF=0xC / SENS _{ii}		mT
B _{SAT}	Magnetic saturation onset	50			mT
OFFS	Deviation from expected 0mT output		0		LSB
OFFS _{THD}	Offset thermal drift, Delta from 25°C ⁽⁶⁾		< ±1000		LSB
SENS _{XX} , SENS _{YY}	Programming range of magnetic resolution (μT/LSB) or sensitivity (LSB/mT) ⁽⁷⁾ [modifying GAIN_SEL and RES _{XYZ}], cfr. Table 17: Sensitivity table for given gain and	3.220		0.161	μT/LSB
		311		6211	LSB/mT
SENS _{ZZ}		5.872		0.294	μT/LSB

⁶ The offset thermal drift is defined as the deviation at 0Gauss from the output with respect to the output at 25°C when sweeping the temperature. The highest gradient (μT/°C) typically occurs at 85°C. The spec value is based on characterization on limited sample size at GAIN_SEL=0x7 and RES_XYZ=0x00.

⁷ The total axis sensitivity is programmable to support different applications, but has no Automatic Gain control on-chip as do the other angular position sensors from Melexis. The highest gain corresponds to at least the minimum +/-4.8mT magnetic measurement range and the magnetic resolution defined by SENS_{ii}.

Parameter	Remark	Min	Nom	Max	Unit
	resolution selection for HALLCONF=0xC	170		3406	LSB/mT

Parameter	Remark	Min	Nom	Max	Unit
SENS _{X_Y} , SENS _{Y_X}	Cross-axis sensitivity (X/Y-axis sensitivity to Y/X magnetic fields)		< ±1		%
SENS _{X_Z} , SENS _{Y_Z}	Cross-axis sensitivity (X/Y-axis sensitivity to Z magnetic field)		< ±1		%
SENS _{Z_X} , SENS _{Z_Y}	Cross-axis sensitivity (Z-axis sensitivity to X and Y magnetic fields)		< ±1		%
SENS _{THD}	Sensitivity thermal drift Delta from 25°C ⁽⁸⁾	-3		+3	%

Table 9: Magnetic Specifications

⁸ The sensitivity thermal drift is expressed as a band around the sensitivity at 25°C. It is applicable on wafer level trimming, but can be influenced by packaging (overmolding).

13.1. Noise vs Conversion Time

The MLX90393 provides configurable filters to adjust the tradeoff between current consumption, noise, and conversion time. See section 15.1.5 for details on selecting the conversion time by adjusting OSR and DIG_FILT.

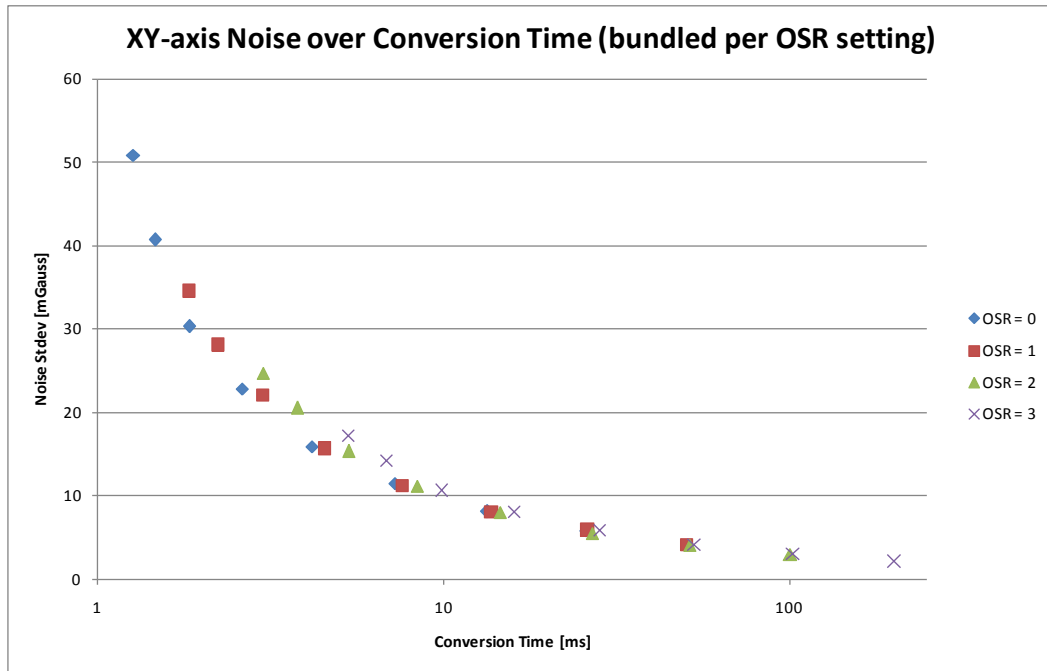

Figure 2: XY axis RMS noise versus conversion time, expressed in mGauss for GAIN_SEL = 0x7

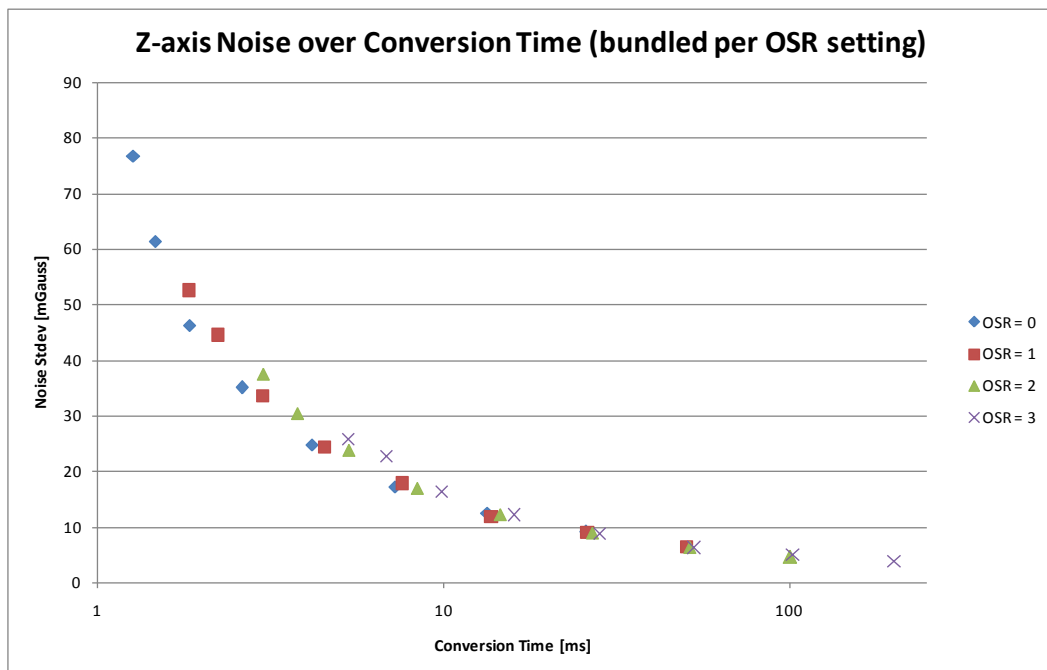

Figure 3: Z axis RMS noise versus conversion time, expressed in mGauss for GAIN_SEL = 0x7

14. Mode Selection

The MLX90393 can operate in three modes. They are: Burst mode, Single Measurement mode, and Wake-On-Change mode.

- Burst mode

The ASIC will have a programmable data rate at which it will operate. This data rate implies auto-wakeup and sequencing of the ASIC, flagging that data is ready on a dedicated pin (INT/DRDY). The maximum data rate corresponds to continuous burst mode, and is a function of the chosen measurement axes. For non-continuous burst modes, the time during which the ASIC has a counter running but is not doing an actual conversion is called the Standby mode (STBY).

- Single Measure mode

The master will ask for data via the corresponding protocol (I²C or SPI), waking up the ASIC to make a single conversion, immediately followed by an automatic return to sleep mode (IDLE) until the next polling of the master. This polling can also be done by strobing the TRG pin instead, which has the same effect as sending a protocol command for a single measurement.

- Wake-Up on Change

This mode is similar to the burst mode in the sense that the device will be auto-sequencing, with the difference that the measured component(s) is/are compared with a reference and in case the difference is bigger than a user-defined threshold, the DRDY signal is set on the designated pin. The user can select which axes and/or temperature fall under this cyclic check, and which thresholds are allowed.

The user can change the operating mode at all time through a specific command on the bus. The device waits in IDLE mode after power-up, but with a proper user command any mode can be set after power-up. Changing to Burst or WOC mode, coming from Single Measure mode, is always accompanied by a measurement first. The top-level state diagram indicating the different modes and some relevant timing is shown below in Figure 4. In the Measure state, the MDATA flag will define which components will be measured (ZYXT). The order of conversion is defined as TXYZ and cannot be modified by the user, only the combination of axes is a degree of freedom.

Arrows indicated in grey are the direct result of an Exit command. The main difference between STANDBY and WOC_IDLE is that in STANDBY mode, all analog circuitry is ready to make a conversion, but this is accompanied by a larger current consumption than IDLE mode. For burst mode this extra current consumption is justified because the emphasis is more on accurate timing intervals, avoiding the delay of T_{STBY} before conversion and supporting an efficient continuous burst mode without standby overhead.

It is the user's responsibility to read back the measured data as the MLX90393 is a slave device on the bus. Even in burst mode and WOC mode when the MLX90393 is auto-sequencing, the master will be responsible for collecting the acquired sensor data.

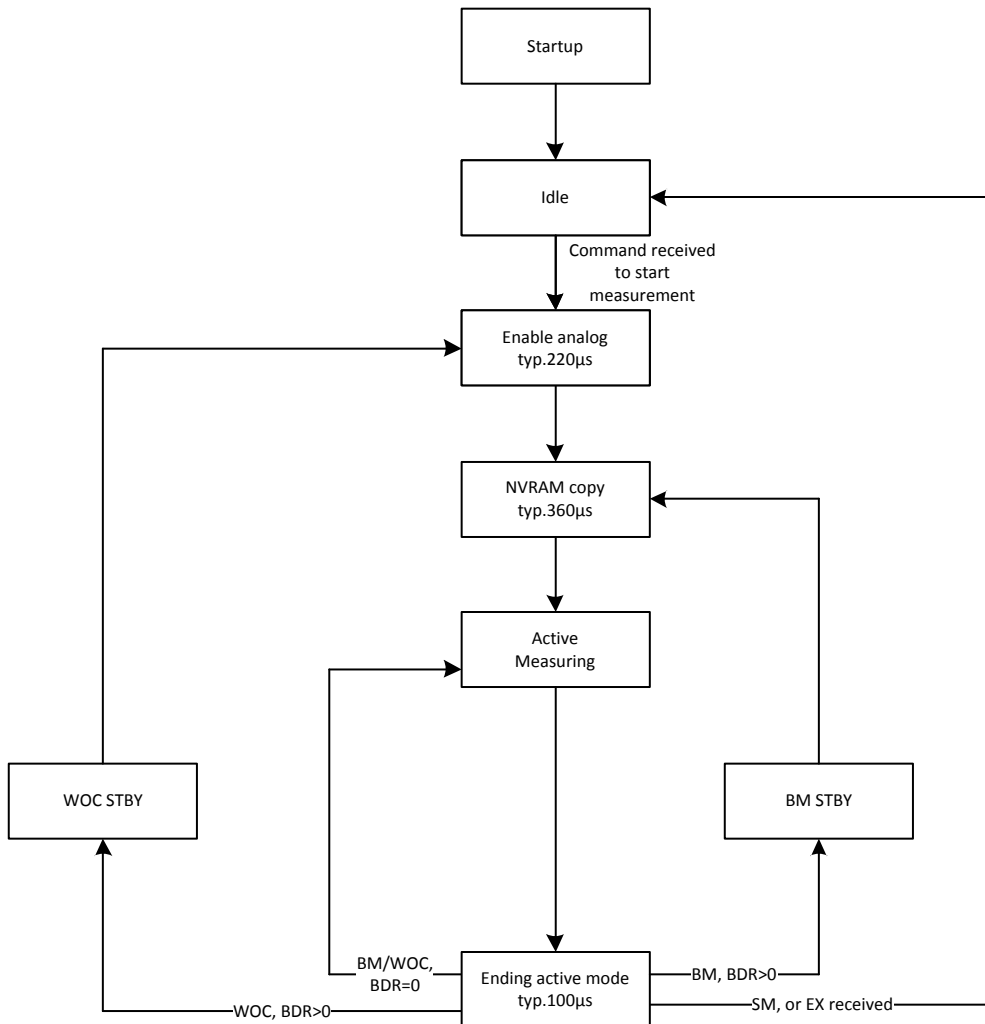

Figure 4: Top-level state diagram with indication of timings

14.1. Burst mode

When the sensor is operating in burst mode, it will make conversions at specific time intervals. The programmability of the user is the following:

- Burst speed ($T_{INTERVAL}$) through parameter BURST_DATA_RATE
- Conversion time (T_{CONV}) through parameters OSR, OSR2 and DIG_FILT
- Axes/Temperature (MDATA) through parameter BURST_SEL or via the command argument (ZYXT)

Whenever the MLX90393 has made the selected conversions (based on MDATA), the DRDY signal will be set (active H) on the INT and/or INT/TRG pin to indicate that the data is ready for readback. It will remain high until the master has sent the command to read out at least one of the converted quantities (ZYXT). Should the master have failed to read out any of them by the time the sensor has made a new conversion, the INT/DRDY pin will be strobed low for 10µs, and the next rising edge will indicate a new set of data is ready.

14.2. Single Measurement mode

Whenever the sensor is set to this mode (or after startup) the MLX90393 goes to the IDLE state where it awaits a command from the master to perform a certain acquisition. The duration of the acquisition will be

the concatenation of the T_{STBY} , T_{ACTIVE} , $m \cdot T_{CONVM}$ (with m # of axes) and T_{CONVT} . The conversion time will effectively be programmable by the user (see burst mode), but is equally a function of the required axes/temperature to be measured.

Upon reception of such a polling command from the master, the sensor will make the necessary acquisitions, and set the DRDY signal high to flag that the measurement has been performed and the master can read out the data on the bus at his convenience. The INT/DRDY will be cleared either when:

- The master has issued a command to read out at least one of the measured components
- The master issues an Exit (EX) command to cancel the measurement
- The chip is reset, after POR (Power-on reset) or Reset command (RT)

14.3. Wake-Up on Change mode

The Wake-Up on Change (WOC) functionality can be set by the master with as main purpose to only receive an interrupt when a certain threshold is crossed. The WOC mode will always compare a new burst value with a reference value to assess if the difference between both exceeds a user-defined threshold. The reference value is defined as one of the following:

- The first measurement of WOC mode is stored as reference value once. This measurement at “t=0” is then the basis for comparison or,
- The reference for acquisition(t) is always acquisition(t-1), in such a way that the INT signal will only be set if the derivative of any component exceeds a threshold.

The in-application programmability is the same as for burst mode, but now the thresholds for setting the interrupt are also programmable by the user, as well as the reference, if the latter is data(t=0) or data(t-1).

15. Digital Specification

The supported protocols are I²C and SPI. The SENB/CS pin is used to define the protocol to be used:

- /CS = 0 for SPI, addressing the MLX90393 slave in SPI mode (3- and 4-wire), but releasing this line in between commands (no permanent addressing allowed)
- /CS = 1 for I²C, addressing the MLX90393 slave when the correct address is transmitted over the bus (permanently kept high)

To ensure the activity on the SPI bus cannot be accidentally interpreted as I²C protocol, programming bits are available in the memory of the MLX90393 to force the communication mode. It concerns the COMM_MODE[1:0] bits with the following effect:

COMM_MODE[1]	COMM_MODE[0]	Description
0	X	The mode in which the first valid command is transmitted to the MLX90393 defines the operating mode (SPI or I ² C) for all its future commands, until a reset (hard or soft) is done.
1	0	SPI mode only
1	1	I ² C mode only

Table 10: Communication mode definition

15.1. Command List

The MLX90393 only listens to a specific set of commands. Apart from the Reset command, all commands generate a status byte that can be read out. The table below indicates the 10 different commands that are (conditionally) accepted by the MLX90393. The MLX90393 will always acknowledge a command in I²C, even if the command is not a valid command. Interpreting the associated status byte is the method for verification of command acceptance.

Command Set						
Command Name	Symbol	#	CMD1 byte	CMD2 byte	CMD3 byte	CMD4 byte
Start Burst Mode	SB	1	0001 zyxt	N/A	N/A	N/A
Start Wake-up on Change Mode	SW	2	0010 zyxt	N/A	N/A	N/A
Start Single Measurement Mode	SM	3	0011 zyxt	N/A	N/A	N/A
Read Measurement	RM	4	0100 zyxt	N/A	N/A	N/A
Read Register	RR	5	0101 0abc	{A5...A0,0,0}	N/A	N/A
Write Register	WR	6	0110 0abc	D15...D8	D7...D0	{A5...A0,0,0}
Exit Mode	EX	8	1000 0000	N/A	N/A	N/A
Memory Recall	HR	D	1101 0000	N/A	N/A	N/A
Memory Store	HS	E	1110 0000	N/A	N/A	N/A
Reset	RT	F	1111 0000	N/A	N/A	N/A

Table 11: Command List

The argument for the volatile memory access commands (RR/WR) «abc» should be set to 0x0, in order to get normal read-out and write of the memory.

The argument in all mode-starting commands (SB/SW/SM) is a nibble specifying the conversions to be performed by the sensor in the following order «zyxt». For example, if only Y axis and temperature are to be measured in Single Measurement mode the correct command to be transmitted is 0x35. The sequence of measurement execution on-chip is inverted to «TXYZ», so T will be measured before X, followed by Y and finally Z. By issuing an all-zero «zyxt» nibble, the BURST_SEL value from RAM will be used instead of the empty argument of the command.

15.2. Status Byte

The status byte is the first byte transmitted by the MLX90393 in response to a command issued by the master. It is composed of a fixed combination of informative bits:

bit 7	bit 6	bit 5	bit 4	bit 3	bit 2	bit 1	bit 0
BURST_MODE	WOC_MODE	SM_MODE	ERROR	SED	RS	D1	D0

Table 12: Status Byte Definition

- **MODE bits**
 These bits define in which mode the MLX90393 is currently set. Whenever a mode transition command is rejected, the first status byte after this command will have the expected mode bit cleared, which serves as an indication that the command has been rejected, next to the ERROR bit. The SM_MODE flag can be the result of an SM command or from raising the TRG pin when TRG mode is enabled in the volatile memory of the MLX90393.
- **ERROR bit**
 This bit is set in case a command has been rejected or in case an uncorrectable error is detected in the memory, a so called ECC_ERROR. A single error in the memory can be corrected (see SED bit), two errors can be detected and will generate the ECC_ERROR. In such a case all commands but the RT (Reset) command will be rejected. The error bit is equally set when the master is reading back data while the DRDY flag is low.
- **SED bit**
 The single error detection bit simply flags that a bit error in the non-volatile memory has been corrected. It is purely informative and has no impact on the operation of the MLX90393.
- **RS bit**
 Whenever the MLX90393 gets out of a reset situation – both hard and soft reset – the RS flag is set to highlight this situation to the master in the first status byte that is read out. As soon as the first status byte is read, the flag is cleared until the next reset occurs.
- **D[1:0] bits**
 These bits only have a meaning after the RR and RM commands, when data is expected as a response from the MLX90393. The number of response bytes correspond to $2 \cdot D[1:0] + 2$, so the expected byte counts are either 2, 4, 6 or 8. For commands where no response is expected, the content of D[1:0] should be ignored.

15.3. SPI Communication

The MLX90393 can handle SPI communication at a bitrate of 10Mhz. The SPI communication is implemented in a half-duplex way, showing high similarities with I²C communication, but addressing through the \CS (Chip Select) pin instead of through bus arbitration. The half-duplex nature is at the basis of the supported 3-wire SPI operation. SPI mode 3 is implemented: CPHA=1 (data changed on leading edge and captured on trailing edge), and CPOL=1 (high level is inactive state). The Chip Select line is active-low.

The communication is also bundled in bytes, equally MSB first and MSByte first. A command can of course consist of more than 1 byte (refer to Table 10: Communication mode definition) as can the response be from the MLX90393 in the form of multiple bytes after the status byte (not shown in Figure 5: SPI communication example)

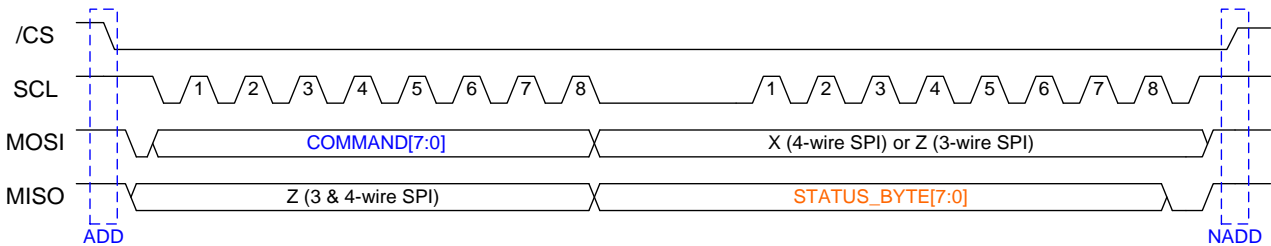

Figure 5: SPI communication example

15.3.1. Command implementation

For the examples give, the below convention is used.



Figure 6: SPI convention

15.3.1.1. SB, SWOC, SM, EX, HR, HS

All the commands follow the structure below. The reply from the MLX90393 is only the status byte. The example below is for a start of a burst mode with X and Y being measured.

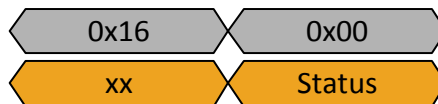

Figure 7: SB command, XY

After the HS command, wait at least 15ms before sending the next command to allow the IC to update the NVRAM correctly.

15.3.1.2. RT

This command will (warm-)reset the IC. The status byte of the command following will indicate the reset event. It is recommended to perform an 'EX' command before issuing a 'RT' command.

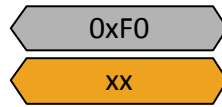

Figure 8: RT command

15.3.1.3. RM

This command differs depending on the value for zyxt. The data is returned in the order Status-TXYZ, where the components which are set to zero are skipped.

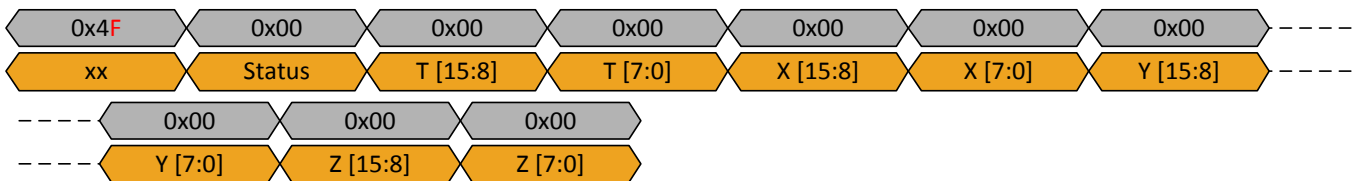

Figure 9: RM command, XYZT

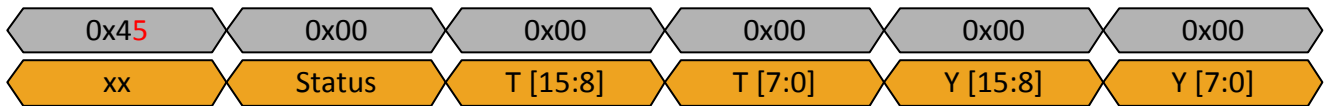

Figure 10: RM command, YT

15.3.1.4. RR

Important in this command is that the register address to be read needs to be shifted left by two bits. To read register 0x12 for example, the MOSI byte becomes 0x48.

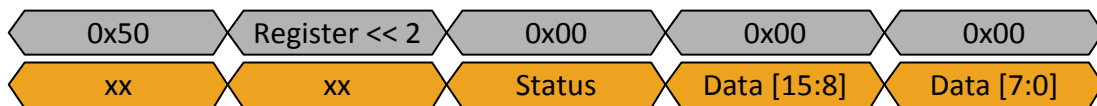

Figure 11: RR command

15.3.1.5. WR

Important in this command is that the register address to be read needs to be shifted left by two bits. To read register 0x12 for example, the MOSI byte becomes 0x48.

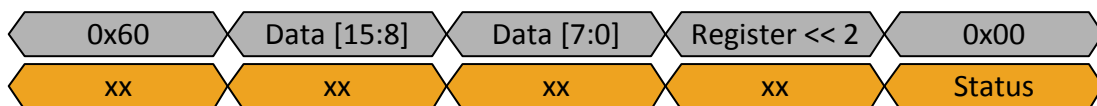

Figure 12: WR command

15.3.2. SPI Timing Specification

All timings are referred to the levels found in Table 6: General Electrical Specifications.

Electrical Parameter	Symbol	Min.	Max.	Unit
SPI Clock Cycle	t_c (SPC)	100		ns
SPI Clock Cycle	t_c (SPC)		10	MHz
CS Setup Time	t_{su} (CS)	5		ns
CS Hold Time	t_h (CS)	10		ns
SDI Input Setup Time	t_{su} (SI)	5		ns
SDI Input Hold Time	t_h (SI)	15		ns
SDO Valid Output Time	t_v (SO)		50	ns
SDO Output Hold Time	t_h (SO)	5		ns
SDO Output Disable Time	t_{dis} (SO)		50	ns

Table 13: General SPI Timing Specification

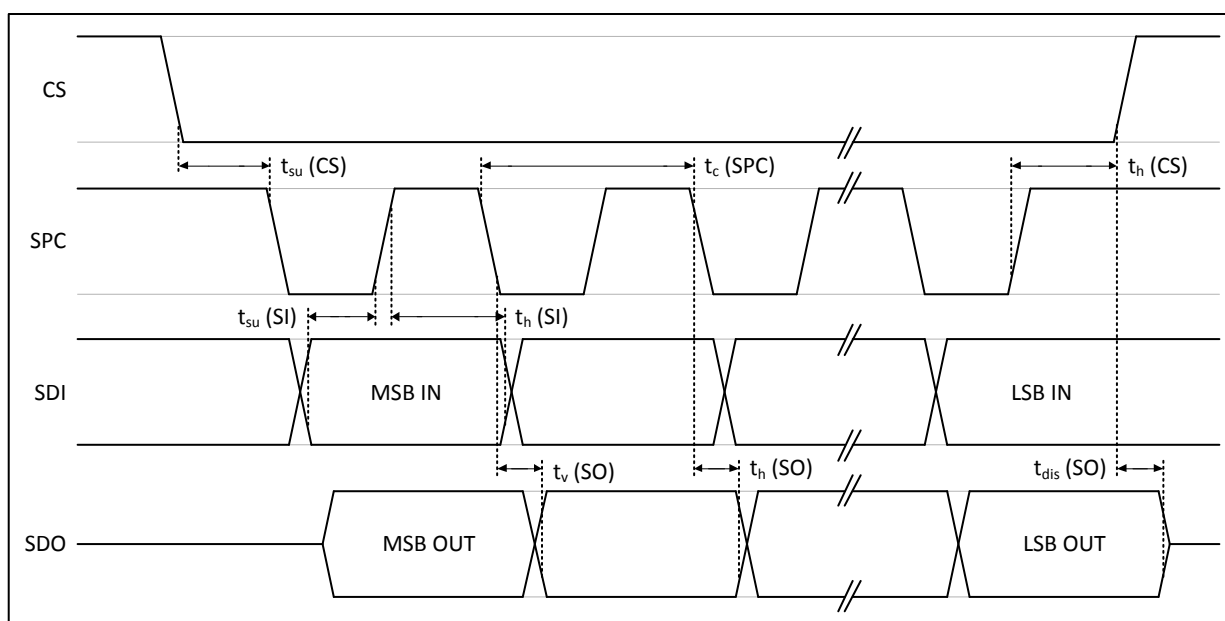

Figure 13: SPI Timing Diagram

15.4. I²C Communication

The I²C protocol is implemented such that the command is written to a specific register in the RAM, and the status and measurement data are read back from this RAM. The commands themselves are the same as for SPI (section 15.3) except for the read measurement commands and the memory read/write commands. For memory read/write commands, written can be done directly to the required register. Note that memory read/write commands are required to be word-wise, so always in multiples of 2 bytes. Read measurement is the same as a memory read, except starting from the status register. MSbits are sent first.

The 7-bit I²C-address is determined by the connection to the A0 and A1 pins. The 5 MSBs are programmed by Melexis in the MLX90393. Please contact Melexis in case other addressing is required.

7-bit I ² C address							R/W bit
7	6	5	4	3	2	1	0
0	0	0	1	1	0 if A1 shorted to ground 1 if A1 shorted to supply	0 if A0 shorted to ground 1 if A0 shorted to supply	0 for I ² C write 1 for I ² C read

Ordering Code	EE_I2C_ADDR[4:0]	7-bit I ² C addresses possible
MLX90393xLW-ABA-011-RE	0x03	0x0C, 0x0D, 0x0E, 0x0F
MLX90393xLW-ABA-012-RE	0x04	0x10, 0x11, 0x12, 0x13
MLX90393xLW-ABA-013-RE	0x05	0x14, 0x15, 0x16, 0x17
MLX90393xLW-ABA-014-RE	0x06	0x18, 0x19, 0x1A, 0x1B
MLX90393xLQ-ABA-011-RE	0x04	0x10

Table 14: I²C address ordering codes

15.4.1. Command Implementation

For the examples given, the below convention is used.

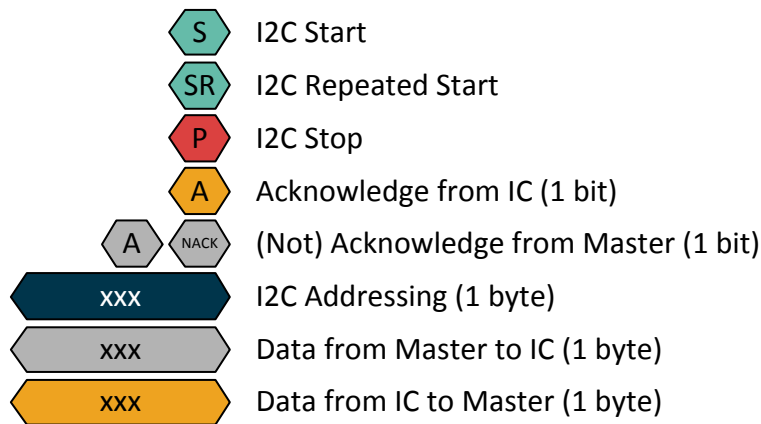

Figure 14: I²C Convention

15.4.1.1. SB, SWOC, SM, EX, HR, HS

All the commands follow the structure below. The reply from the MLX90393 is only the status byte. The example below is for a start of a burst mode with X and Y being measured.



Figure 15: SB command, XY

After the HS command, wait at least 15ms before sending the next command to allow the IC to update the NVRAM correctly.

15.4.1.2. RT

This command will (warm-)reset the IC. The status byte of the command following will indicate the reset event. It is recommended to perform an 'EX' command before issuing a 'RT' command.



Figure 16: RT command

15.4.1.3. RM

This command differs depending on the value for zyxt. The data is returned in the order Status-TXYZ, where the components which are set to zero are skipped.



Figure 17: RM command-XYZT



Figure 18: RM command-YT

15.4.1.4. RR

Important in this command is that the register address to be read needs to be shifted left by two bits. To read register 0x12 for example, the SDA byte becomes 0x48.

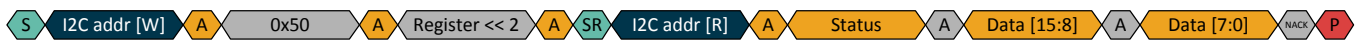

Figure 19: RR command

15.4.1.5. WR

Important in this command is that the register address to be read needs to be shifted left by two bits. To read register 0x12 for example, the SDA byte becomes 0x48.

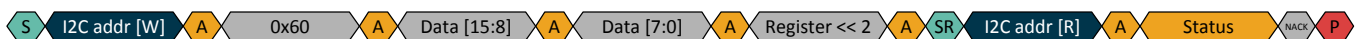

Figure 20: WR command

15.4.2. I²C Timing Specification

All timings are referred to the levels found in Table 6: General Electrical Specifications.

Electrical Parameter	Symbol	I ² C Standard Mode		I ² C Fast Mode		Unit
		Min.	Max.	Min.	Max.	
SCL Clock Frequency	f (SCL)		100		400	kHz
SCL Clock Low Time	t _w (SCLL)	4.7		1.3		µs
SCL Clock High Time	t _w (SCLH)	4		0.6		µs
SDA Setup Time	t _{su} (SDA)	250		100		ns
SDA Data Hold Time	t _h (SDA)		3.45	0	0.9	µs
SDA and SCL Rise Time	t _r (SDA) t _r (SCL)		1000	20+0.1*C _b ⁽⁹⁾	300	ns
SDA and SCL Fall Time	t _f (SDA) t _f (SCL)		300	20+0.1*C _b ⁽⁹⁾	300	ns
START Condition Hold Time	t _h (ST)	4		0.6		µs
REPEATED START Condition Setup Time	t _{su} (SR)	4.7		0.6		µs
STOP Condition Setup Time	t _{su} (SP)	4		0.6		µs
Bus Free Time Between STOP and START Condition	t _w (SP:ST)	4.7		1.3		µs

Table 15: General I²C Timing Specification

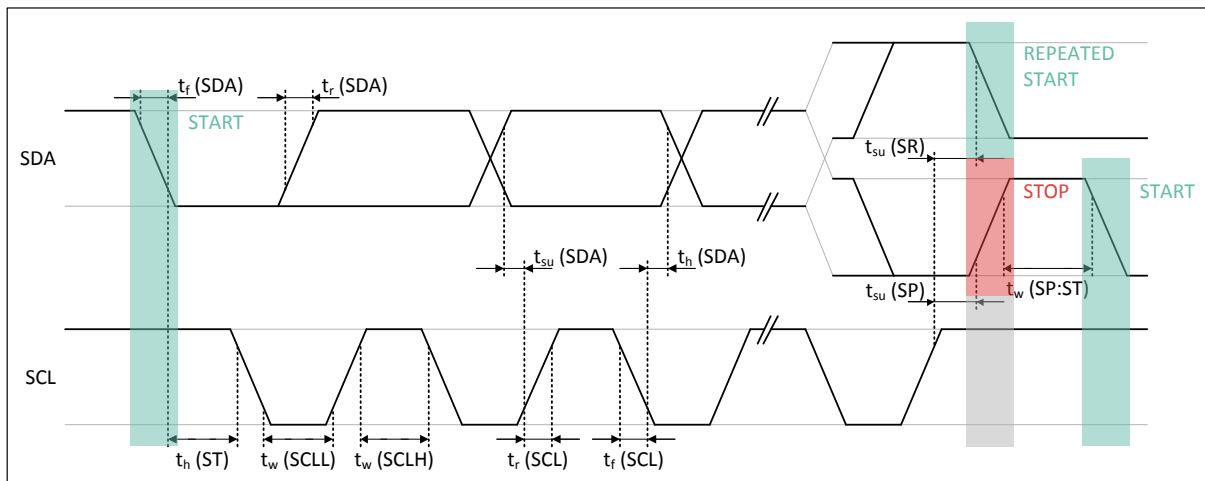

Figure 21: I²C Timing Diagram

⁹ Where C_b is the total bus capacitance (in pF)

16. Memory Map

16.1. General Description

The MLX90393 has 1kbit of non-volatile memory, and the same amount of volatile memory. Each memory consists out of 64 addresses containing 16 bit words. The non-volatile memory has automatic 2-bit error detection and 1-bit error correction capabilities per address. The handling of such corrections & detections is explained in Section 15.2.

The memory is split in 2 areas:

- Customer area [address 0x00 to 0x1F]
- Melexis area [address 0x20 to 0x3F]

The RR and WR commands impact the volatile memory only, there no direct access possible to the non-volatile memory. The customer area of the volatile memory is bidirectionally accessible to the customer; the Melexis area is write-protected. Only modifications in the blue area are allowed with the WR command. The adjustments in the customer area can be stored in the permanent non-volatile memory with the STORE command HS, which copies the entire volatile memory including the Melexis area to the non-volatile one. With the HR command the non-volatile memory content can be recalled to the volatile memory, which can restore any modifications due to prior WR commands. The HR step is performed automatically at start-up of the ASIC, either through cold reset or warm reset with the RT command.

The above is graphically shown in Figure 22.

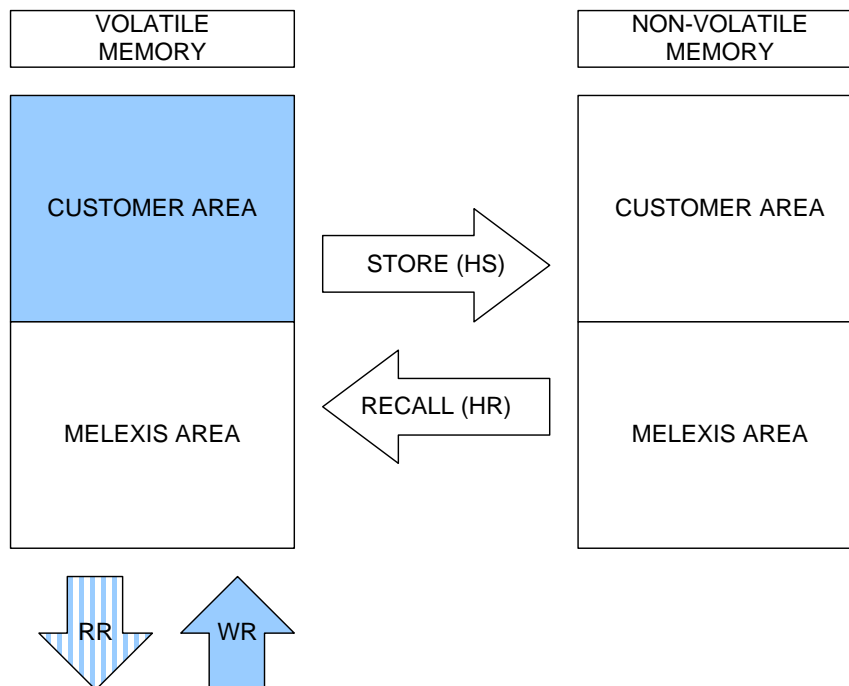

Figure 22: The memories of the MLX90393, their areas and the impacting commands.

The customer area houses 3 types of data:

- Analog configuration bits
- Digital configuration bits
- Informative (free) bits

The latter can be filled with customer content freely, and covers the address span from (and including) 0x0A to 0x1F, a total of 352 bits. The memory mapping of volatile and non-volatile memory on address level is identical. The volatile memory map is given in Figure 23.

The table below gives an overview of the customer area in the MLX90393’s NVRAM.

In the register map, the 16-bit words are split into 2 bytes for the sake of readability. The general format is shown below in the yellow table.

Register	Bit 7	Bit 6	Bit 5	Bit 4	Bit 3	Bit 2	Bit 1	Bit 0
0x..	Bit 7	Bit 6	Bit 5	Bit 4	Bit 3	Bit 2	Bit 1	Bit 0 (LSB)
	Bit 15 (MSB)	Bit 14	Bit 13	Bit 12	Bit 11	Bit 10	Bit 9	Bit 8

Register	Bit 7	Bit 6	Bit 5	Bit 4	Bit 3	Bit 2	Bit 1	Bit 0
0x00h	Z-SERIES	GAIN_SEL			HALLCONF			
	ANA_RESERVED_LOW							BIST
0x01h	BURST_SEL (zyxt)		BURST_DATA_RATE (BDR)					
	TRIG_INT	COMM_MODE	WOC_DIFF	EXT_TRG	TCMP_EN	BURST_SEL (zyxt)		
0x02h	RES_Y	RES_X	DIG_FILT			OSR		
				OSR2	RES_Z		RES_Y	
0x03h	SENS_TC_LT							
	SENS_TC_HT							
0x04h	OFFSET_X							
	OFFSET_X							
0x05h	OFFSET_Y							
	OFFSET_Y							
0x06h	OFFSET_Z							
	OFFSET_Z							
0x07h	WOXY_THRESHOLD							
	WOXY_THRESHOLD							
0x08h	WOZ_THRESHOLD							
	WOZ_THRESHOLD							
0x09h	WOT_THRESHOLD							
	WOT_THRESHOLD							
0x0Ah	FREE							
...								
0x1Fh								

Figure 23: Customer area memory map.

The non-volatile memory can only be written (HS store command) if pin VDD is supplied with 3.3V minimum, otherwise the write sequence cannot be performed in a reliable way. Additionally, this HS command was designed to be used as one-time calibration, but not as multi write-cycle memory within the application. In

case memory is written within the application, the number of write cycles should be kept to a minimum. There is no limit to the write cycles in the volatile memory (WR write command).

16.2. Parameter Description

The meaning of each customer accessible parameter is explained in this section. The customer area of both the volatile and the non-volatile memory can be written through standard SPI and I²C communication, within the application. No external high-voltages are needed to perform such operations, nor access to dedicated pins that need to be grounded in the application.

Parameter	Description
ANA_RESERVED_LOW	Reserved IO trimming bits
BIST	Enabled the on-chip coil, applying a Z-field [Built-In Self Test]
Z_SERIES	Enable all plates for Z-measurement
GAIN_SEL[2:0]	Analog chain gain setting, factor 5 between min and max code
HALLCONF[3:0]	Hall plate spinning rate adjustment
TRIG_INT_SEL	Puts TRIG_INT pin in TRIG mode when cleared, INT mode otherwise
COMM_MODE[1:0]	Allow only SPI [10b], only I ² C [11b] or both [0Xb] according to CS pin
WOC_DIFF	Sets the Wake-up On Change based on $\Delta\{\text{sample}(t), \text{sample}(t-1)\}$
EXT_TRIG	Allows external trigger inputs when set, if TRIG_INT_SEL = 0
TCMP_EN	Enables on-chip sensitivity drift compensation
BURST_SEL[3:0]	Defines the MDATA in burst mode if SB command argument = 0
BURST_DATARATE[6:0]	Defines T _{INTERVAL} as BURST_DATA_RATE * 20ms
OSR2[1:0]	Temperature sensor ADC oversampling ratio
RES_XYZ[5:0]	Selects the desired 16-bit output value from the 19-bit ADC
DIG_FILT[1:0]	Digital filter applicable to ADC
OSR[1:0]	Magnetic sensor ADC oversampling ratio
SENS_TC_HT[7:0]	Sensitivity drift compensation factor for T < T _{REF}
SENS_TC_LT[7:0]	Sensitivity drift compensation factor for T > T _{REF}
OFFSET_i[15:0]	Constant offset correction, independent for i = X, Y, Z

Parameter	Description
WOi_THRESHOLD[15:0]	Wake-up On Change threshold, independent for i = X, Y, Z and T

Table 16: NVRAM parameter description

16.2.1. ANA_RESERVED_LOW

Reserved bits for analog trimming at Melexis factory. Do not modify.

16.2.2. BIST

Enables (1) or disables (0) the built in self-test coil. In normal operation set to 0. A measurement with this coil enabled shows a change in magnetic field sensed on the Z-axis.

16.2.3. Z_Series

Enables series connection of hall plates for Z axis measurement. In normal operation set to 0.

16.2.4. GAIN_SEL[2:0]

Sets the analog gain to the desired value. The sensitivity is dependent on the axis (the X- and Y-axis have higher sensitivity, compared with the Z-axis, expressed in LSB/ μ T) as well as the setting of the RES_XYZ[5:0] parameter. The relationship is given in the below table.

Table for HALLCONF⁽¹⁰⁾ = 0xC, sensitivity in μ T/LSB, TC off, T=25°C:

GAIN_SEL	RES = 0		RES = 1		RES = 2		RES = 3	
	SENS _{XY}	SENS _Z	SENS _{XY}	SENS _Z	SENS _{XY}	SENS _Z	SENS _{XY}	SENS _Z
0	0.751	1.210	1.502	2.420	3.004	4.840	6.009	9.680
1	0.601	0.968	1.202	1.936	2.403	3.872	4.840	7.744
2	0.451	0.726	0.901	1.452	1.803	2.904	3.605	5.808
3	0.376	0.605	0.751	1.210	1.502	2.420	3.004	4.840
4	0.300	0.484	0.601	0.968	1.202	1.936	2.403	3.872
5	0.250	0.403	0.501	0.807	1.001	1.613	2.003	3.227
6	0.200	0.323	0.401	0.645	0.801	1.291	1.602	2.581
7	0.150	0.242	0.300	0.484	0.601	0.968	1.202	1.936

Table 17: Sensitivity table for given gain and resolution selection for HALLCONF=0xC

Table for HALLCONF⁽¹⁰⁾ = 0xC, sensitivity in μ T/LSB, TC off, T=35°C:

GAIN_SEL	RES = 0		RES = 1		RES = 2		RES = 3	
	SENS _{XY}	SENS _Z	SENS _{XY}	SENS _Z	SENS _{XY}	SENS _Z	SENS _{XY}	SENS _Z
0	0.787	1.267	1.573	2.534	3.146	5.068	6.292	10.137
1	0.629	1.014	1.258	2.027	2.517	4.055	5.034	8.109
2	0.472	0.760	0.944	1.521	1.888	3.041	3.775	6.082
3	0.393	0.634	0.787	1.267	1.573	2.534	3.146	5.068
4	0.315	0.507	0.629	1.014	1.258	2.027	2.517	4.055
5	0.262	0.422	0.524	0.845	1.049	1.689	2.097	3.379
6	0.210	0.338	0.419	0.676	0.839	1.352	1.678	2.703
7	0.157	0.253	0.315	0.507	0.629	1.014	1.258	2.027

Table 18: Sensitivity table for given gain and resolution selection for HALLCONF=0xC

¹⁰ For HALLCONF = 0x0, the sensitivity scales with a factor 98/75. For example (0.150 μ T/LSB with HALLCONF 0xC becomes 0.196 μ T/LSB with HALLCONF 0x0)

16.2.5. HALLCONF[3:0]

Modifies the hall plate spinning (2-phase vs 4-phase) which has an effect on the minimum sampling rate achievable. Some configurations of OSR and DIG_FILT are not permitted. The cells shown in red are not permitted with HALL_CONF=0xC (default) but are allowed when HALL_CONF=0x0.

Typical $T_{CONV}(TXYZ)$ for $OSR_2=0x0$ [ms]		OSR			
		0	1	2	3
DIG_FILT	0	1.27	1.84	3.00	5.30
	1	1.46	2.23	3.76	6.84
	2	1.84	3.00	5.30	9.91
	3	2.61	4.53	8.37	16.05
	4	4.15	7.60	14.52	28.34
	5	7.22	13.75	26.80	52.92
	6	13.36	26.04	51.38	102.07
	7	25.65	50.61	100.53	200.37

Table 19: T_{CONV} as a function of OSR & DIG_FILT

Maximum ODR for $OSR_2=0x0$ [Hz]		OSR			
		0	1	2	3
DIG_FILT	0	716.9	493.0	303.4	171.5
	1	622.7	408.0	241.5	133.0
	2	493.0	303.4	171.5	91.8
	3	348.0	200.6	108.6	56.6
	4	219.2	119.6	62.6	32.1
	5	125.9	66.1	33.9	17.2
	6	68.0	34.9	17.7	8.9
	7	35.4	18.0	9.0	4.5

Table 20: Maximum Output Data Rate (ODR) as a function of OSR & DIG_FILT

16.2.6. TRIG_INT_SEL

When set to 0 the TRIG_INT pin is in trigger mode. When set to 1 the TRIG_INT pin acts as an interrupt pin.

16.2.7. COMM_MODE[1:0]

When set to 0x2 only SPI communication is allowed. When set to 0x3 only I²C communication is allowed. When set to 0x0 or 0x1 both communication modes can be used but the selection is made by the CS pin.

16.2.8. WOC_DIFF

When wake-on-change mode is enabled this parameter defines the mode to use. When enabled, a comparison on the current measurement is made with the previous measurement. When disabled, the first initial measurement is used as a reference.

16.2.9. EXT_TRIG

Allows for external trigger events when set to 1 and TRIG_INT_SEL = 0. When enabled an acquisition will start with the external trigger pin detects a high value. Acquisitions will continue to be triggered until the EXT_TRIG pin is brought low.

16.2.10. TCMP_EN

Enables (1) or disables (0) the on-chip sensitivity drift compensation. Enabling the temperature compensation will influence the way the magnetic values are encoded and transmitted to the system microcontroller as shown in the table below.

ABA		TCMP_EN = 0x0		TCMP_EN = 0x1	
		RANGE	TYPE	RANGE	TYPE
RES _i	0	±2 ¹⁵	2's complement 0μT = 0LSB	±2 ¹⁵	unsigned 0μT = 2 ¹⁵ LSB
	1	±2 ¹⁵	2's complement 0μT = 0LSB	±2 ¹⁵	unsigned 0μT = 2 ¹⁵ LSB
	2	±22000	unsigned 0μT = 2 ¹⁵ LSB	N/A	
	3	±11000	unsigned 0μT = 2 ¹⁴ LSB		

Table 21: Output Range and Type as a function of TCMP_EN and RES_XYZ={RES_x,RES_y,RES_z}

16.2.11. BURST_SEL[3:0]

Defines the axes that will be converted in burst mode if the SB command argument is 0.

16.2.12. OSR2[1:0]

Selects the temperature sensor ADC oversampling ratio

16.2.13. RES_XYZ[5:0]

See 16.2.4 for the relationship between the gain and resolution. Additionally, section 16.2.10 for the relationship between RES_XYZ and the output data format.

16.2.14. DIG_FILT[1:0]

See 16.2.5 for the selection of DIG_FILT and the impact on conversion time.

16.2.15. OSR[1:0]

Oversampling ratio for the magnetic measurements. See 16.2.5 for the selection of OSR

16.2.16. SENS_TC_HT[7:0]

Sensitivity drift compensation factor for T > T_{REF}

16.2.17. SENS_TC_LT[7:0]

Sensitivity drift compensation factor for $T < T_{REF}$

16.2.18. OFFSET_i[15:0]

Constant offset correction, independent of temperature, and programmable for each individual axis where $i=X, Y, \text{ or } Z$.

16.2.19. WOi_THRESHOLD[15:0]

Wake-on-change threshold. Independently programmable for each magnetic axis ($i=X, Y, Z$) and temperature ($i=T$)

18. Packaging Specification

18.1. QFN-16

The MLX90393 shall be delivered in a QFN-16 package as shown below in Figure 26.

18.1.1. Package dimensions and sensitive spot location

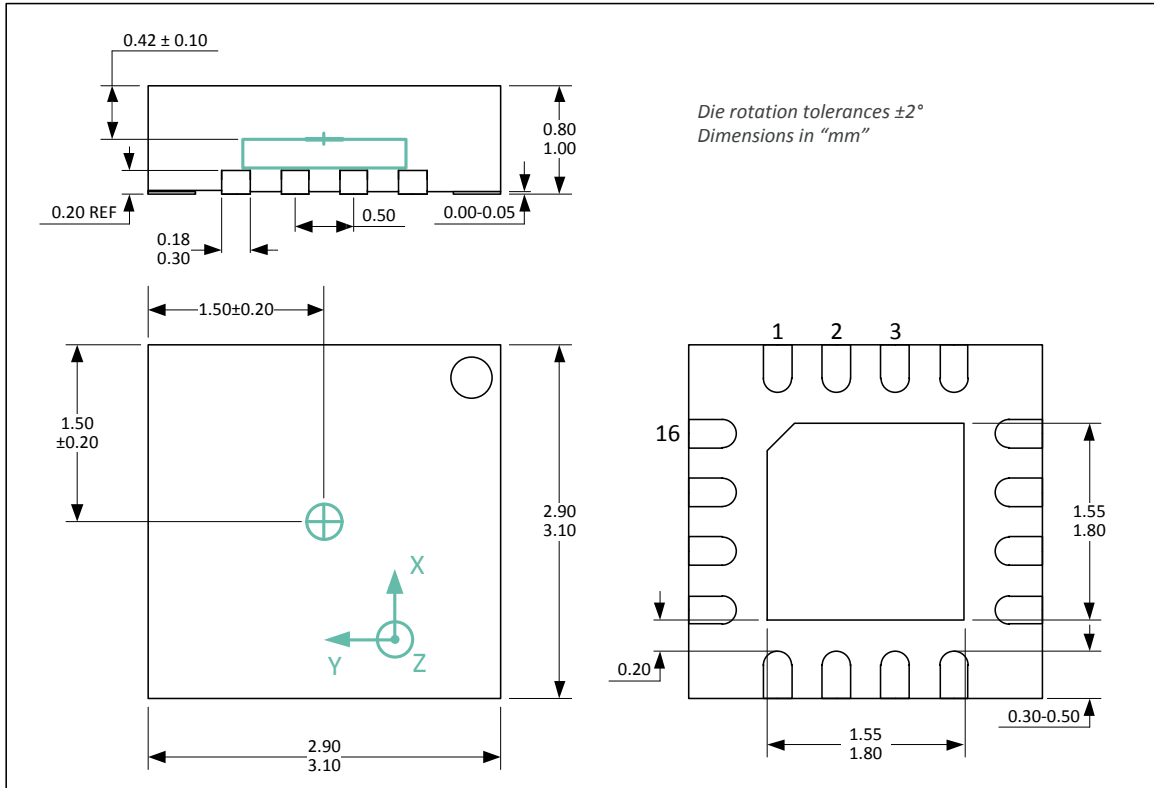

Figure 26: QFN-16 - Package Outline Drawing

The sensing elements – Hall plates with the patented IMC technology – are located in the center of the die, which on its turn is located in the center of the package.

18.1.2. QFN-16 - Pinout and Marking

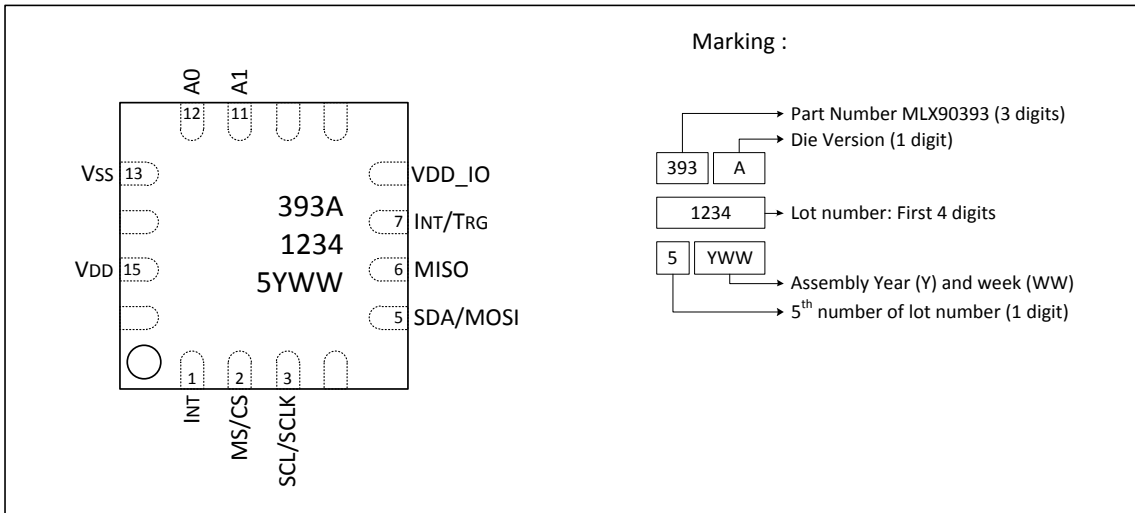

Figure 27: QFN-16 Pinout and Marking – Top view

18.2. UDFN-8 package

The MLX90393 shall be delivered in a UDFN-8 package as shown below in Figure 28:

18.2.1. Package dimensions and sensitive spot location

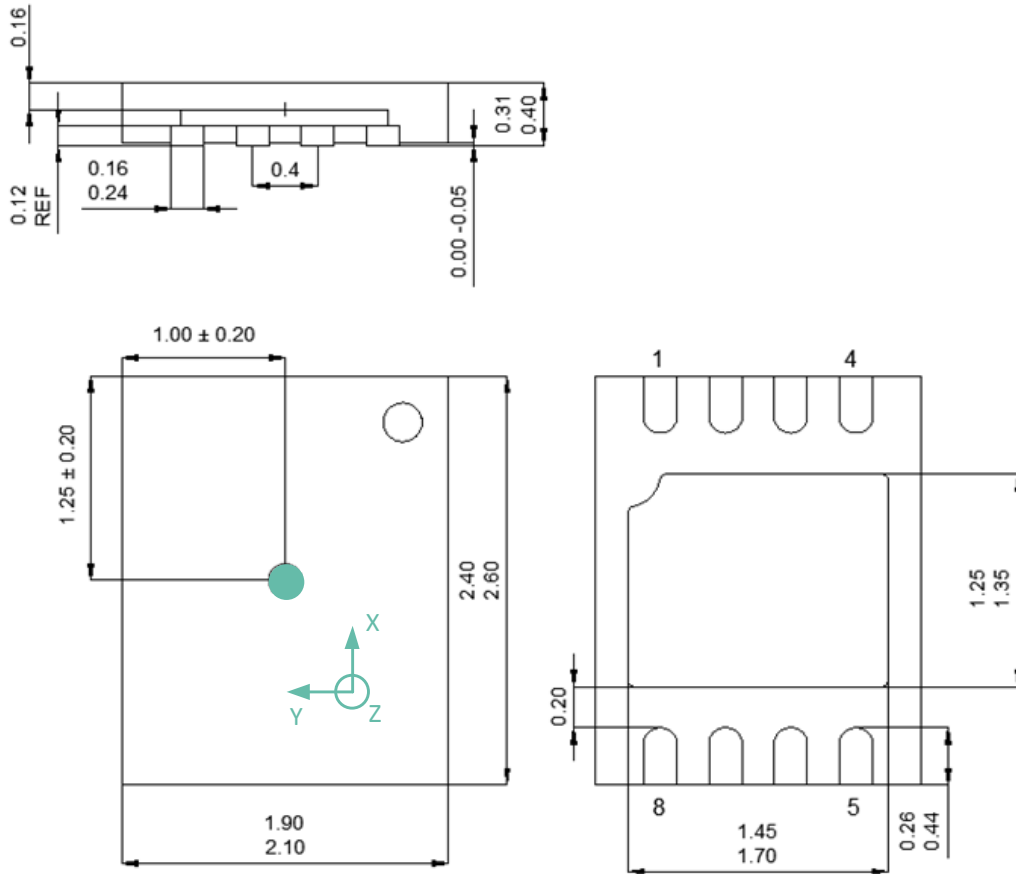

Figure 28: UDFN-8 - Package Outline Drawing

18.2.2. UTDFN-8 - Pinout and Marking

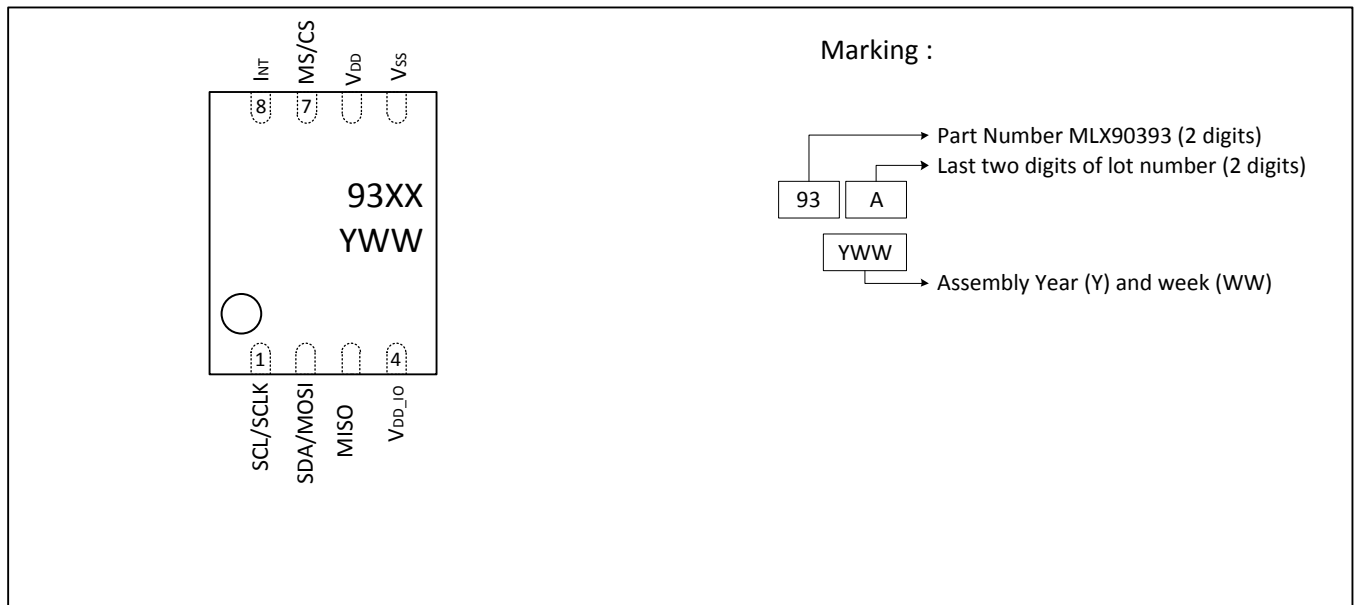

Figure 29: UTDFN-8 – Pinout and Marking

19. Standard Information

Our products are classified and qualified regarding soldering technology, solderability and moisture sensitivity level according to standards in place in Semiconductor industry.

For further details about test method references and for compliance verification of selected soldering method for product integration, Melexis recommends reviewing on our web site the General Guidelines [soldering recommendation](#). For all soldering technologies deviating from the one mentioned in above document (regarding peak temperature, temperature gradient, temperature profile, etc.), additional classification and qualification tests have to be agreed upon with Melexis.

For package technology embedding trim and form post-delivery capability, Melexis recommends to consult the dedicated trim & form recommendation application note: [lead trimming and forming recommendations](#)

Melexis is contributing to global environmental conservation by promoting **lead free** solutions. For more information on qualifications of **RoHS** compliant products (RoHS = European directive on the Restriction Of the use of certain Hazardous Substances) please visit the quality page on our website: <http://www.melexis.com/en/quality-environment>

20. ESD Precautions

Electronic semiconductor products are sensitive to Electro Static Discharge (ESD). Always observe Electro Static Discharge control procedures whenever handling semiconductor products.

21. Revision History

Date	Revision	Remark
11-Nov-2014	001	<ul style="list-style-type: none"> First Document Release
16-Feb-2015	002	<ul style="list-style-type: none"> Changed Ordering Code to indicate QFN wettable flanks Update Document number Added description of yellow cells in Table 1 and Table 2.
13-Jul-2017	003	<ul style="list-style-type: none"> Added additional ordering codes for up to 16 sensors on the same bus and their description in Table 2 Added E temperature code for -40°C capable products and the associated update of the operating range in chapter 3 Updated template to new Melexis format
28-May-2019	004	<ul style="list-style-type: none"> UTDFN-8 Package / Pinout/ Marking Updated sensitivity tables Additional Communication commands details Functional flowchart updated Timings and current consumption updated
08-Jan-2020	006	<ul style="list-style-type: none"> Additional specifications of Idd, IdletoStby, Idd, Active and Idd,Conv_end
14-Jan-2021	007	<ul style="list-style-type: none"> RR + WR in I2C: typo (one bit->two bits) Sensitivity chapter: footer, and footnote corrected; uT to μT. Added note that sensitivity increase is in LSB/μT. RM commands: wrong explanation RES_XYZ[5:0] and DIG_FILT[1:0]: corrected cross references OSR[1:0]: link to HALLCONF added I2C timing diagram I2C address of UTDFN (was 0001100, now 0010000), in both option codes and table (I2C chapter) BIST: some more explanation

22. Contact

For the latest version of this document, go to our website at www.melexis.com.

For additional information, please contact our Direct Sales team and get help for your specific needs:

Europe, Africa	Telephone: +32 13 67 04 95
	Email : sales_europe@melexis.com
Americas	Telephone: +1 603 223 2362
	Email : sales_usa@melexis.com
Asia	Email : sales_asia@melexis.com

23. Disclaimer

The content of this document is believed to be correct and accurate. However, the content of this document is furnished "as is" for informational use only and no representation, nor warranty is provided by Melexis about its accuracy, nor about the results of its implementation. Melexis assumes no responsibility or liability for any errors or inaccuracies that may appear in this document. Customer will follow the practices contained in this document under its sole responsibility. This documentation is in fact provided without warranty, term, or condition of any kind, either implied or expressed, including but not limited to warranties of merchantability, satisfactory quality, non-infringement, and fitness for purpose. Melexis, its employees and agents and its affiliates' and their employees and agents will not be responsible for any loss, however arising, from the use of, or reliance on this document. Notwithstanding the foregoing, contractual obligations expressly undertaken in writing by Melexis prevail over this disclaimer.

This document is subject to change without notice, and should not be construed as a commitment by Melexis. Therefore, before placing orders or prior to designing the product into a system, users or any third party should obtain the latest version of the relevant information. Users or any third party must determine the suitability of the product described in this document for its application, including the level of reliability required and determine whether it is fit for a particular purpose.

This document as well as the product here described may be subject to export control regulations. Be aware that export might require a prior authorization from competent authorities. The product is not designed, authorized or warranted to be suitable in applications requiring extended temperature range and/or unusual environmental requirements. High reliability applications, such as medical life-support or life-sustaining equipment or avionics application are specifically excluded by Melexis. The product may not be used for the following applications subject to export control regulations: the development, production, processing, operation, maintenance, storage, recognition or proliferation of:

- 1. chemical, biological or nuclear weapons, or for the development, production, maintenance or storage of missiles for such weapons;*
- 2. civil firearms, including spare parts or ammunition for such arms;*
- 3. defense related products, or other material for military use or for law enforcement;*
- 4. any applications that, alone or in combination with other goods, substances or organisms could cause serious harm to persons or goods and that can be used as a means of violence in an armed conflict or any similar violent situation.*

No license nor any other right or interest is granted to any of Melexis' or third party's intellectual property rights.

If this document is marked "restricted" or with similar words, or if in any case the content of this document is to be reasonably understood as being confidential, the recipient of this document shall not communicate, nor disclose to any third party, any part of the document without Melexis' express written consent. The recipient shall take all necessary measures to apply and preserve the confidential character of the document. In particular, the recipient shall (i) hold document in confidence with at least the same degree of care by which it maintains the confidentiality of its own proprietary and confidential information, but no less than reasonable care; (ii) restrict the disclosure of the document solely to its employees for the purpose for which this document was received, on a strictly need to know basis and providing that such persons to whom the document is disclosed are bound by confidentiality terms substantially similar to those in this disclaimer; (iii) use the document only in connection with the purpose for which this document was received, and reproduce document only to the extent necessary for such purposes; (iv) not use the document for commercial purposes or to the detriment of Melexis or its customers. The confidentiality obligations set forth in this disclaimer will have indefinite duration and in any case they will be effective for no less than 10 years from the receipt of this document.

This disclaimer will be governed by and construed in accordance with Belgian law and any disputes relating to this disclaimer will be subject to the exclusive jurisdiction of the courts of Brussels, Belgium.

The invalidity or ineffectiveness of any of the provisions of this disclaimer does not affect the validity or effectiveness of the other provisions.

The previous versions of this document are repealed.

Melexis © - No part of this document may be reproduced without the prior written consent of Melexis. (2021)

IATF 16949 and ISO 14001 Certified