

■ Description

The MST53XXB series is a high voltage, ultralow-power, low dropout voltage regulator. The device can deliver 100mA output current with a dropout voltage of 300mV and allows an input voltage as high as 35V. The typical quiescent current is only 1.6 μ A. The device is available in fixed output voltages of 1.8, 3.0, 3.3, 3.6, and 5.0V. The device features integrated short-circuit and thermal shutdown protection.

Although designed primarily as fixed voltage regulators, the device can be used with external components to obtain variable voltages.

■ Application

- Battery-powered equipment
- Smoke detector and sensor
- Microcontroller Applications
- Home Appliance

■ Features

- Low Quiescent Current : 1.6 μ A
- High Input Voltage : Up to 35V
- High Output Current : \geq 200mA
- Low Dropout Voltage :
 - 30mV@10mA
 - 300mV@100mA
 - 600mV@200mA
- Fixed Output Voltages : 1.8, 3.0, 3.3, 3.6, and 5.0V
- High-accuracy Output Voltage
- MST53XXB \pm 2%
- Good Transient Response
- Integrated Short-Circuit Protection
- Integrated Thermal Protection
- Available Packages :

MST53XXBTE	SOT23-3
MST53XXBTG	SOT23-5
MST53XXBTS	SOT89-3

■ Application Circuits

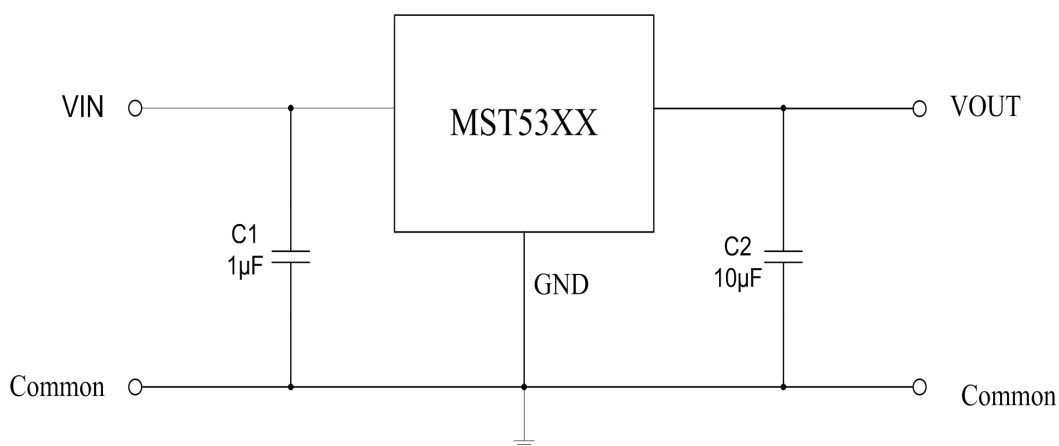

Pin Descriptions

Pin Number			Pin Name	Description
SOT23-3	SOT89-3/TO92	SOT23-5		
1	1	2	GND	Ground Pin
2	3	5	VOUT	Output Pin
3	2	1	VIN	Input Pin

Packages and Pin Assignments

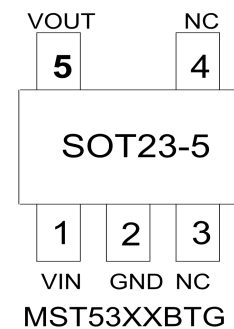
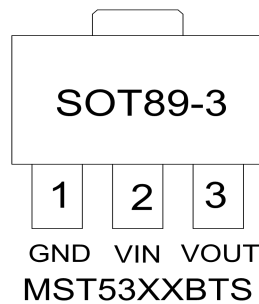
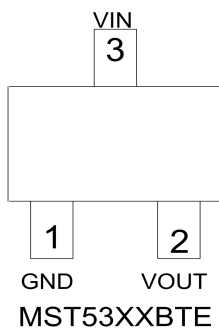

Functional Block Diagram

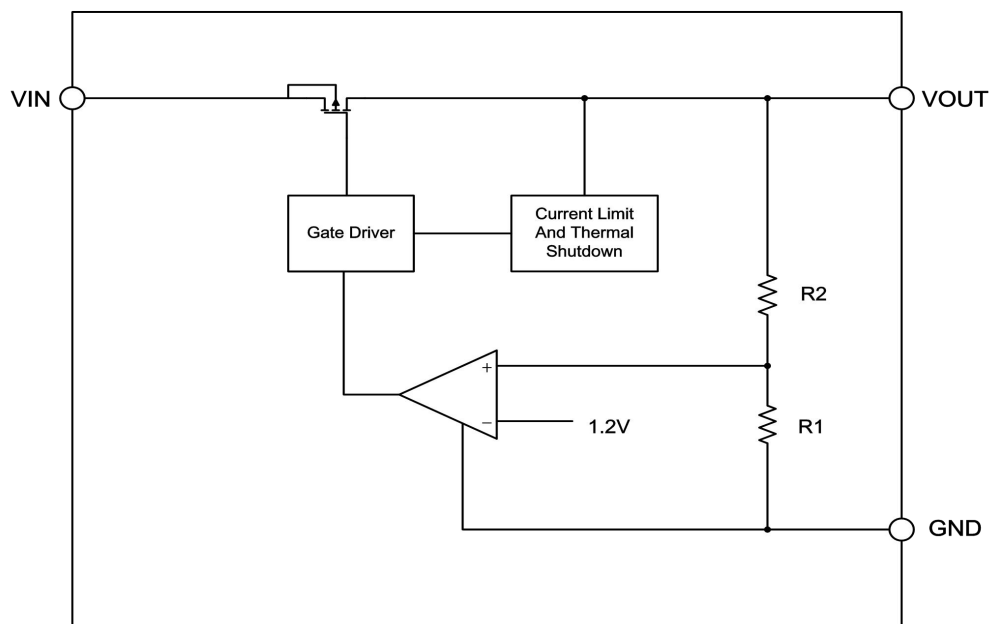

■ Absolute Maximum Ratings

Item	Description	Min	Max	Unit
Voltage	VIN Pin to GND Pin	-0.3	35	V
	VOUT Pin to GND Pin	-0.3	6	V
	VOUT Pin to VIN Pin	-35	0.3	V
Current	Peak Output	Internally limited		
Temperature	Operating Ambient Temperature	-40	85	°C
	Storage Temperature	-40	150	°C
	Operating Virtual Junction Temperature	-	150	°C
Thermal Resistance (Junction to Ambient)	SOT89	180		°C/W
	SOT23-3	380		°C/W
	SOT23-5	300		°C/W
	TO92	200		°C/W
Power Dissipation	SOT89	600		mW
	SOT23-3	300		mW
	SOT23-5	400		mW
	TO92	600		mW
Electrostatic Discharge Rating	Human Body Model (HBM)	4		kV
	Charged Device Model (MM)	100		V

Note : Stresses exceeding the range specified under “Absolute Maximum Ratings” may cause substantial damage to the device. Functional operation of this device at other conditions beyond those listed in the specification is not implied and prolonged exposure to extreme conditions may affect device reliability.

■ Electrical Characteristics

(At $T_A=25^\circ\text{C}$, $C_{IN}=1\mu\text{F}$, $V_{IN}=V_{OUTNOM}+1.0\text{V}$, $C_{OUT}=10\mu\text{F}$, Unless Otherwise Noted)

Symbol	Parameter	Test Conditions	Min	Typ	Max	Unit
V_{IN}	Input Voltage		—	—	35	V
I_{GND}	Quiescent Current	$V_{IN}=12\text{V}$, No load	—	1.6	—	μA
V_{OUT}	Output Voltage	$V_{IN}=12\text{V}$, $I_{OUT}=10\text{mA}$	V_{OUTNOM} * 0.98	V_{OUTNOM}	V_{OUTNOM} * 1.02	V
I_{OUT_MAX}	Output Current		200	250	—	mA
V_{DROP}	Dropout Voltage* ¹ (MST5350)	$I_{OUT}=10\text{mA}$, $\Delta V_{OUT} = -V_{OUTNOM} * 2\%$	—	30	—	mV
		$I_{OUT}=100\text{mA}$, $\Delta V_{OUT} = -V_{OUTNOM} * 2\%$	—	300	—	mV
		$I_{OUT}=200\text{mA}$, $\Delta V_{OUT} = -V_{OUTNOM} * 2\%$	—	600	—	mV
	Dropout Voltage* ¹ (MST5333)	$I_{OUT}=10\text{mA}$, $\Delta V_{OUT} = -V_{OUTNOM} * 2\%$	—	30	—	mV
		$I_{OUT}=100\text{mA}$, $\Delta V_{OUT} = -V_{OUTNOM} * 2\%$	—	300	—	mV
		$I_{OUT}=200\text{mA}$, $\Delta V_{OUT} = -V_{OUTNOM} * 2\%$	—	600	—	mV
ΔV_{OUT}	Load Regulation	$1\text{mA} \leq I_{OUT} \leq 100\text{mA}$	—	20	—	mV
$\frac{\Delta V_{OUT} \times 100}{\Delta V_{IN} \times V_{OUT}}$	Line Regulation	$I_{OUT}=1\text{mA}$, $V_{IN}=(V_{OUTNOM}+1\text{V})$ to 35V	—	0.2	—	%/V
I_{LIMIT}	Current Limit	$V_{IN}=(V_{OUTNOM}+1\text{V})$ to 35V $R_{LOAD}=V_{OUTNOM}/1\text{A}$	—	450	—	mA
T_{SHDN}	Thermal Shutdown Threshold		—	125	—	$^\circ\text{C}$

Note : *1 Dropout Voltage is the voltage difference between the input and the output at which the output voltage drops 2% below its nominal value .

■ Typical Performance Characteristics

Test Condition: $T_A=25^\circ\text{C}$, $V_{in}=12\text{V}$, $I_{out}=1\text{mA}$, $C_{OUT}=10\mu\text{F}$, unless otherwise note

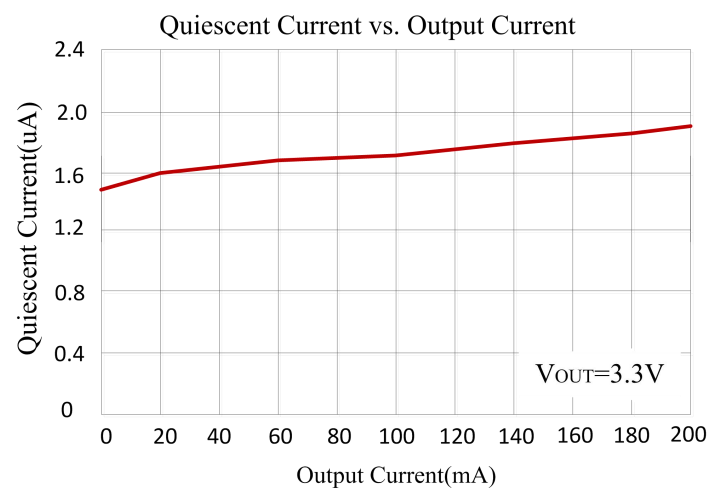
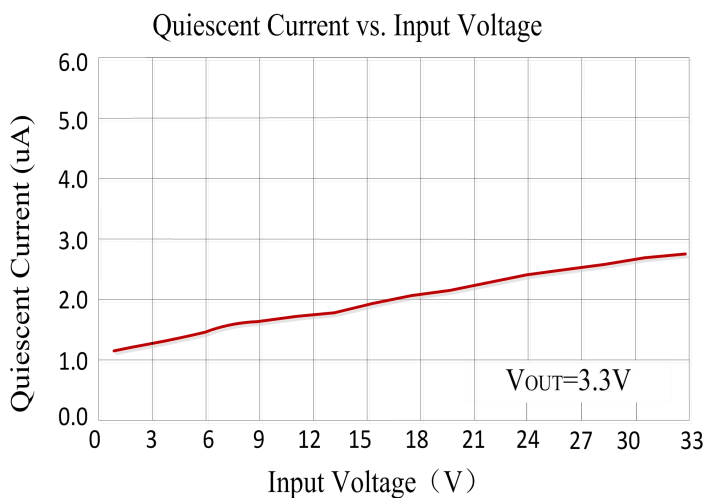
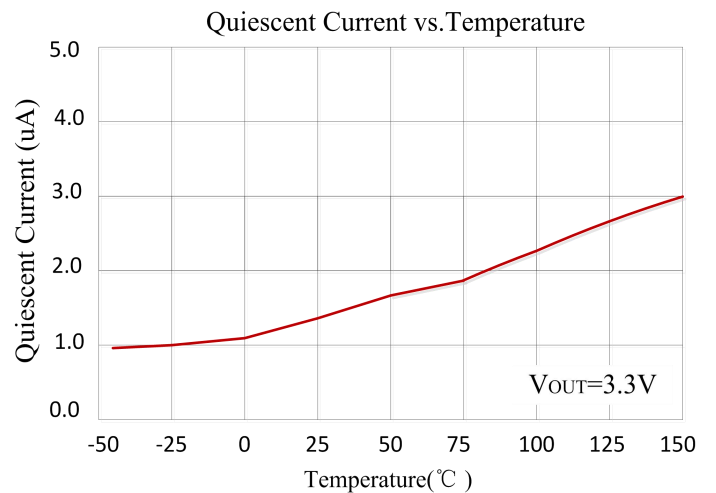
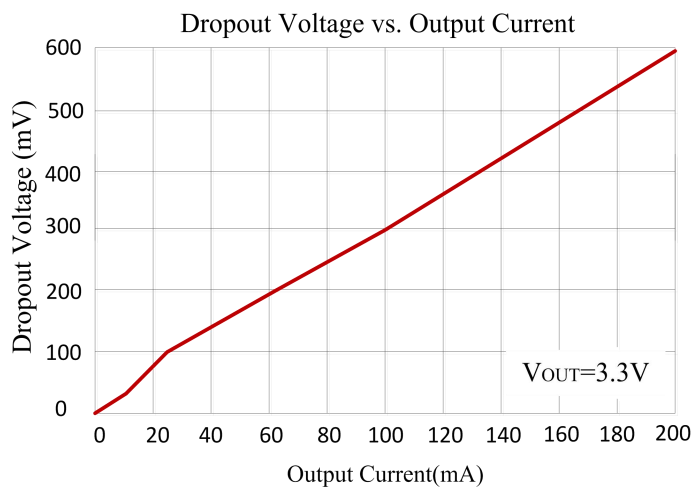
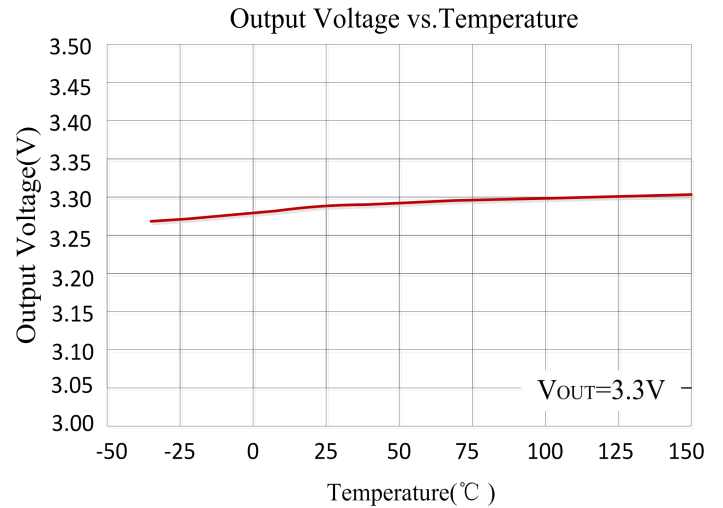
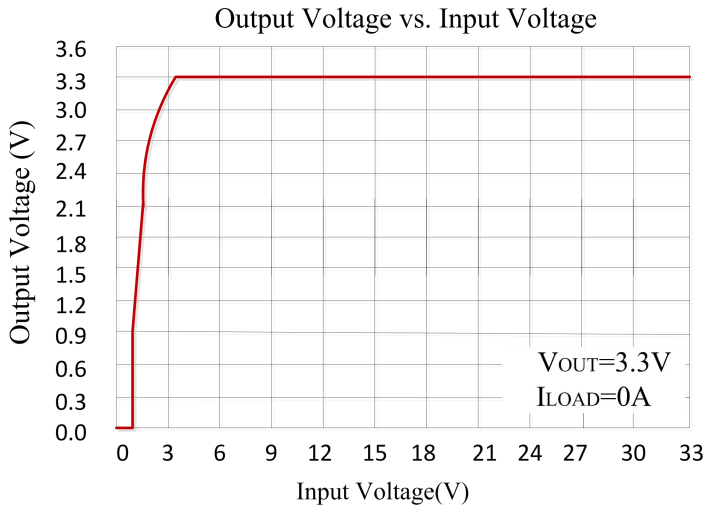

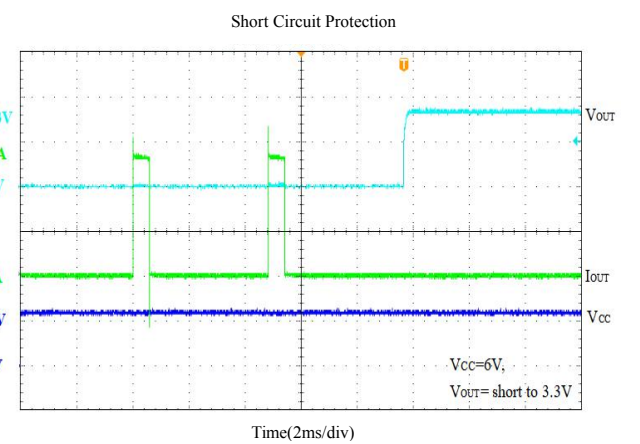
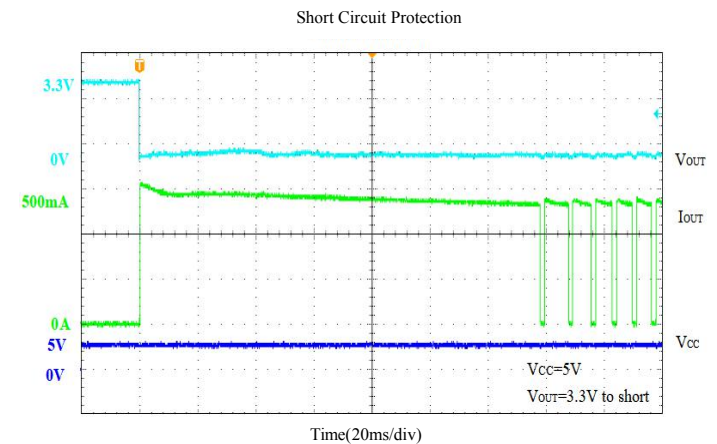
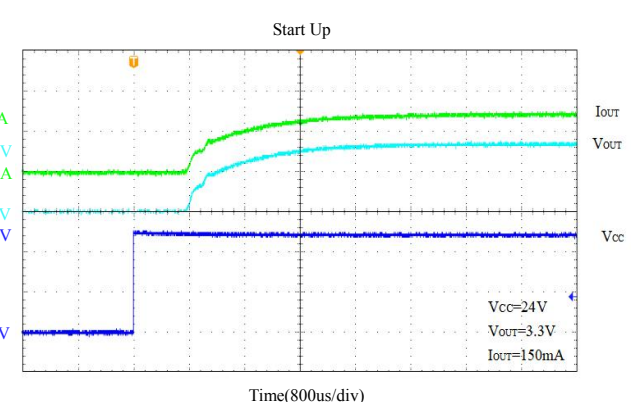
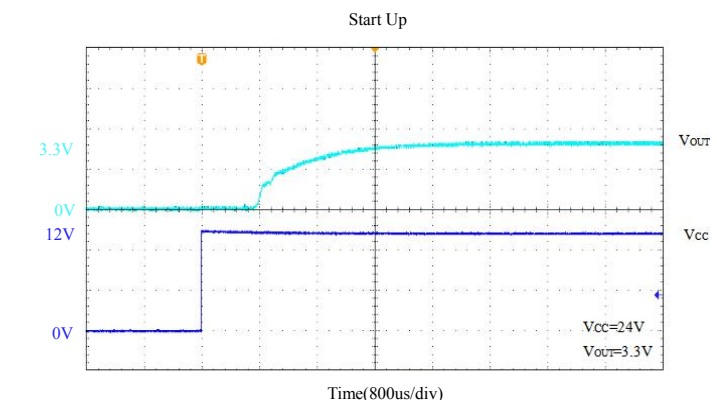
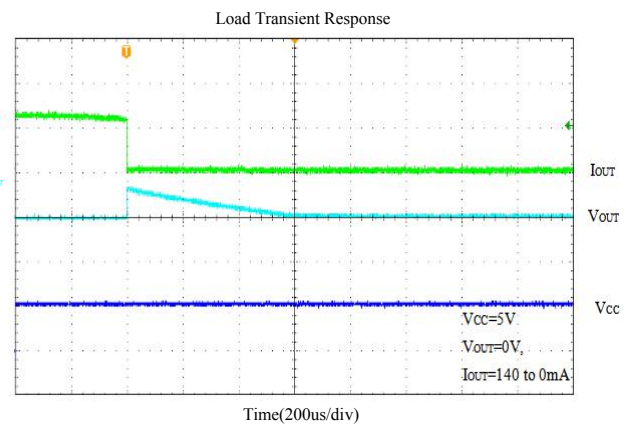
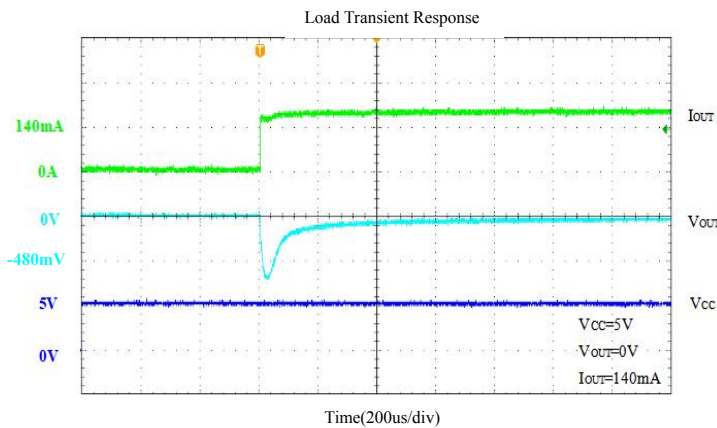
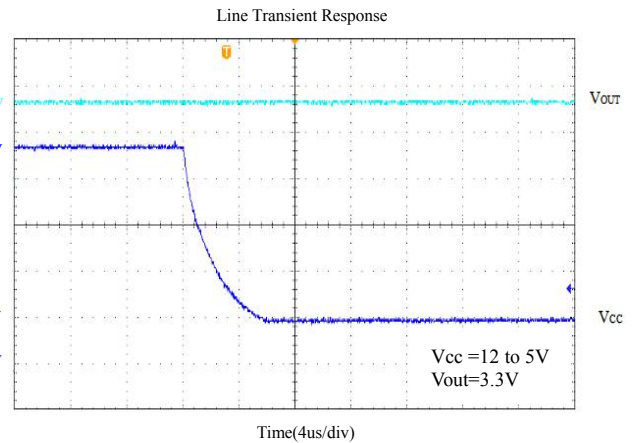
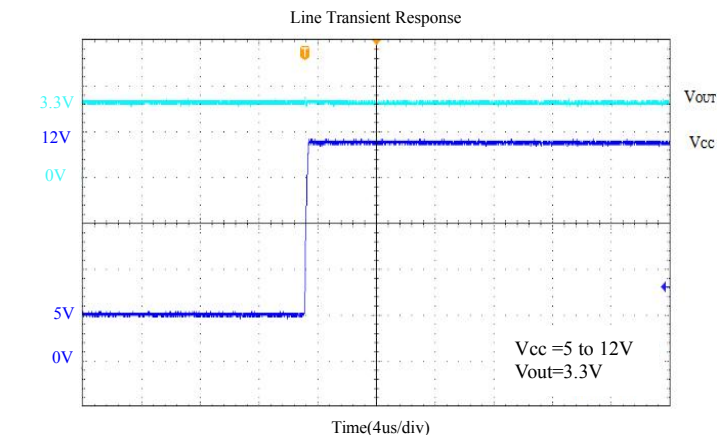

■ Package Outline Dimensions

SOT23-3

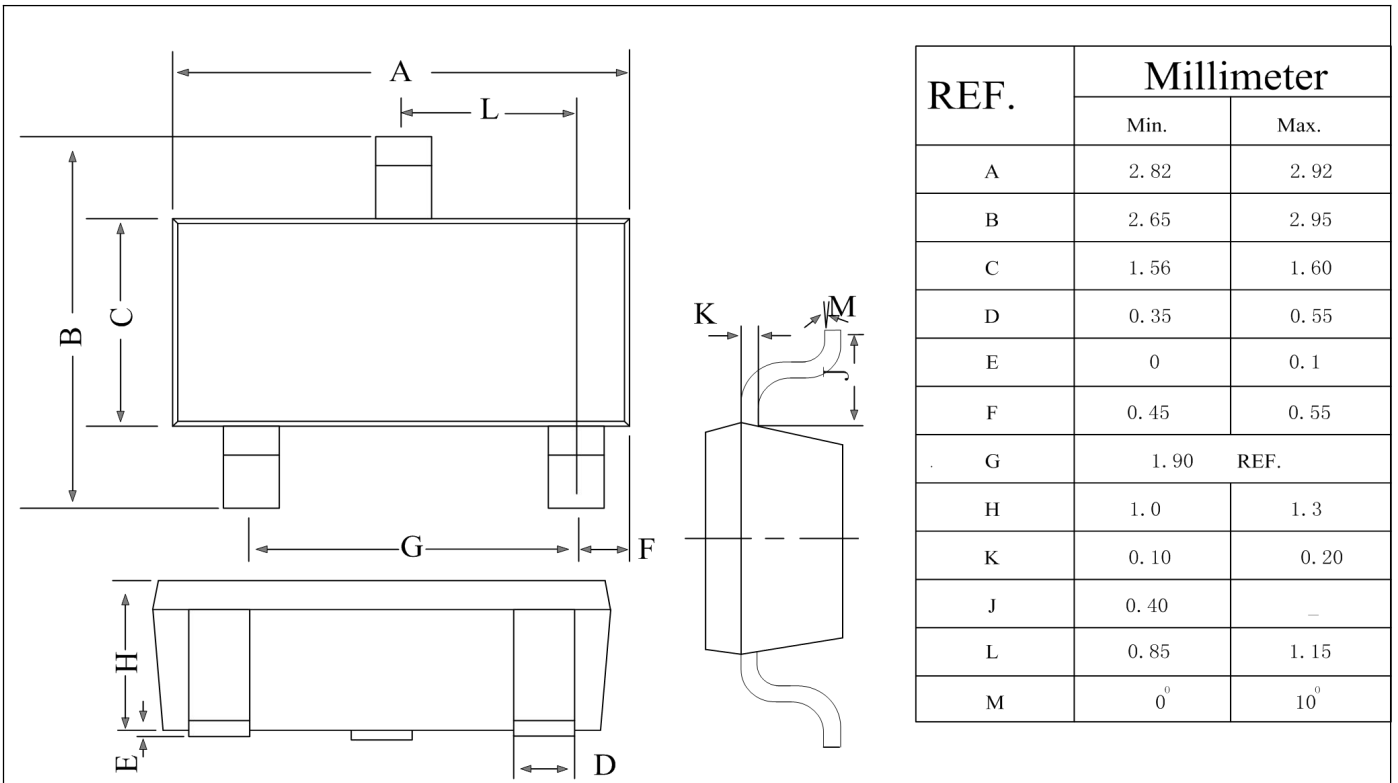

SOT89-3

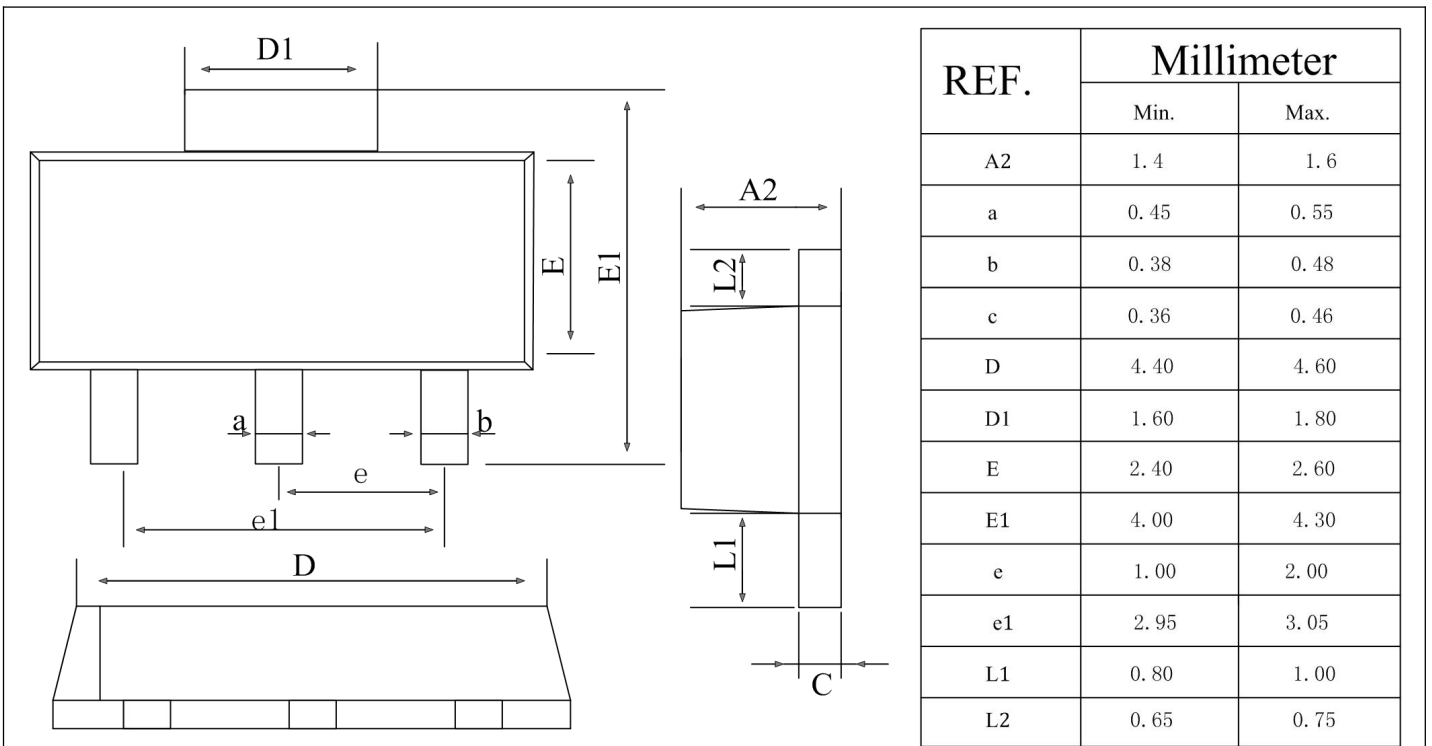

SOT23-5

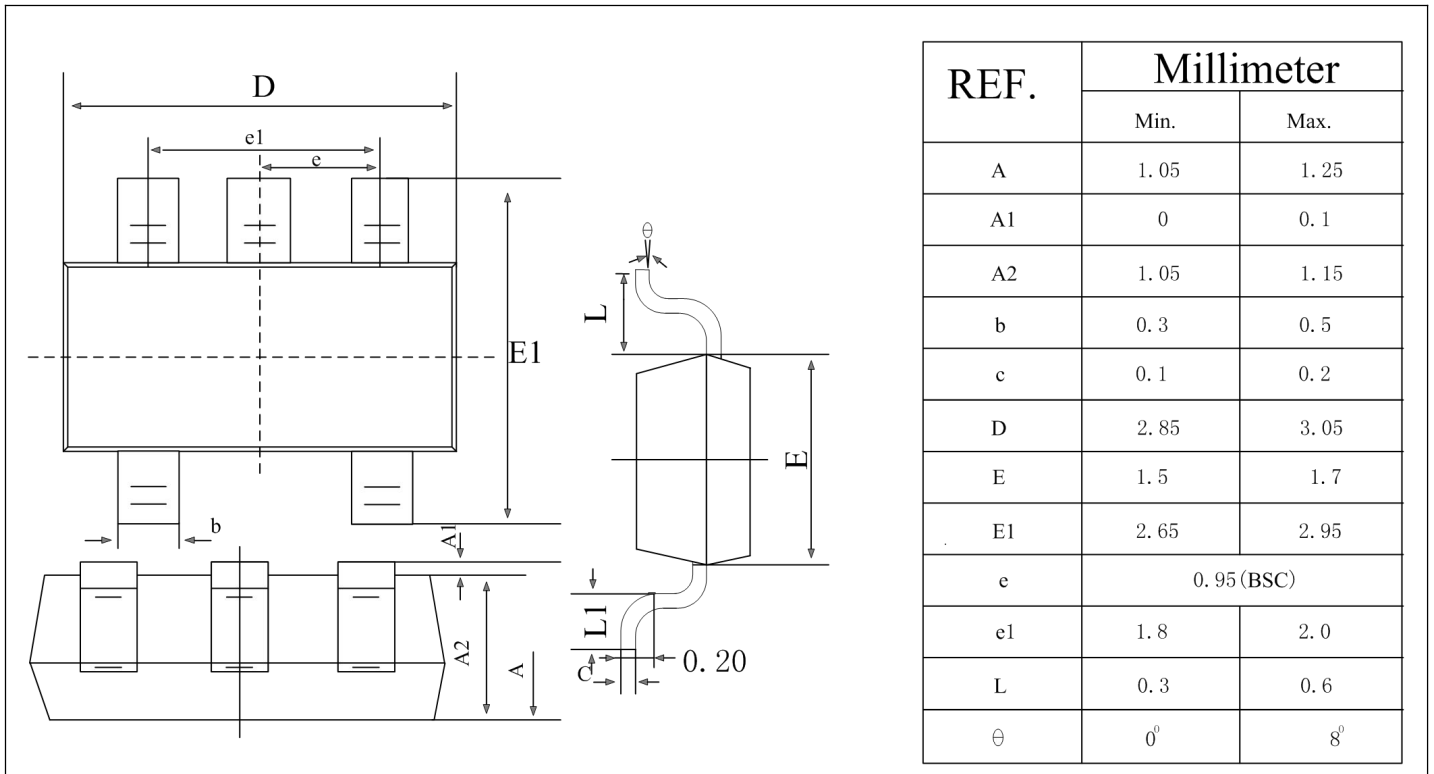

■ Packing information

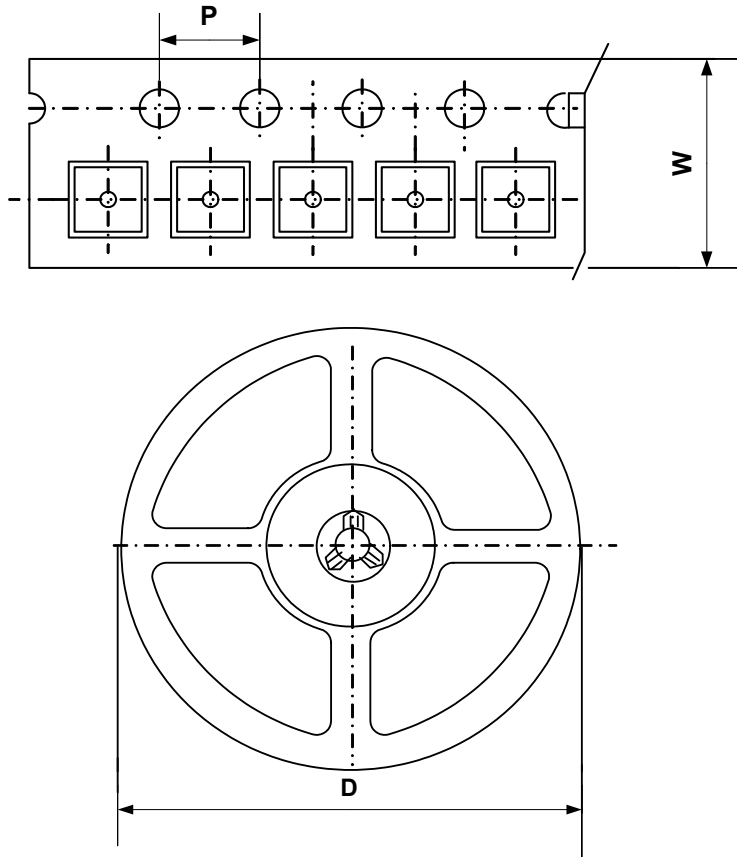

Type	W(mm)	P(mm)	D(mm)	Qty (pcs)
SOT23-3 SOT23-5	12.0 \pm 0.1 mm	8.0 \pm 0.1 mm	330 \pm 1 mm	3000pcs
SOT89-3	/	/	/	1000pcs

IMPORTANT NOTICE

MST INCORPORATED MAKES NO WARRANTY OF ANY KIND, EXPRESS OR IMPLIED, WITH REGARDS TO THIS DOCUMENT, INCLUDING, BUT NOT LIMITED TO, THE IMPLIED WARRANTIES OF MERCHANTABILITY AND FITNESS FOR A PARTICULAR PURPOSE (AND THEIR EQUIVALENTS UNDER THE LAWS OF ANY JURISDICTION).

MST Incorporated and its subsidiaries reserve the right to make modifications, enhancements, improvements, corrections or other changes without further notice to this document and any product described herein. MST Incorporated does not assume any liability arising out of the application or use of this document or any product described herein; neither does MST Incorporated convey any license under its patent or trademark rights, nor the rights of others. Any Customer or user of this document or products described herein in such applications shall assume all risks of such use and will agree to hold MST Incorporated and all the companies whose products are represented on MST Incorporated website, harmless against all damages.

MST Incorporated does not warrant or accept any liability whatsoever in respect of any products purchased through unauthorized sales channel. Should Customers purchase or use MST Incorporated products for any unintended or unauthorized application, Customers shall indemnify and hold MST Incorporated and its representatives harmless against all claims, damages, expenses, and attorney fees arising out of, directly or indirectly, any claim of personal injury or death associated with such unintended or unauthorized application.

Products described herein may be covered by one or more United States, international or foreign patents pending. Product names and markings noted herein may also be covered by one or more United States, international or foreign trademarks.