

Thin-Film RF/Microwave Directional Couplers

CP0302/CP0402/CP0603/CP0805 and DB0603N/DB0805 3dB 90°

CP0805 SMD Type



GENERAL DESCRIPTION

ITF (INTEGRATED THIN-FILM) TECHNOLOGY

The ITF SMD Coupler is based on thin-film multilayer technology. The technology provides a miniature part with excellent high frequency performance and rugged construction for reliable automatic assembly.

The ITF Coupler is offered in a variety of frequency bands compatible with various types of high frequency wireless systems.

FEATURES

- Small Size: 0805
- Frequency Range: 800MHz - 3GHz
- Characteristic Impedance: 50Ω
- Operating / Storage Temp.: -40°C to +85°C
- Power Rating: 3W Continuous
- Low Profile
- Rugged Construction
- Taped and Reeled

APPLICATIONS

- Mobile Communications
- Satellite TV Receivers
- GPS
- Vehicle Location Systems
- Wireless LAN's

DIMENSIONS:

millimeters (inches)

(Top View)

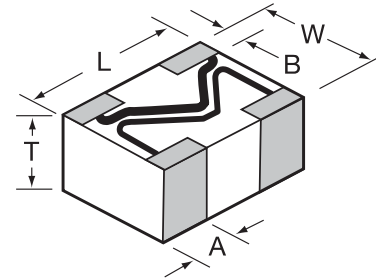

	0805
L	2.03±0.1 (0.080±0.004)
W	1.55±0.1 (0.061±0.004)
T	0.98±0.1 (0.039±0.004)
A	0.56±0.25 (0.022±0.010)
B	0.35±0.15 (0.014±0.006)

HOW TO ORDER

CP Style Directional Coupler	0805 Size 0805	A Layout Type (see layout types)	0902 Frequency MHz	A Sub-Type (see layout sub-types)	S Termination Code W = Nickel/Solder (Sn/Pb) **S = Nickel / Lead Free Solder (Sn100)	TR Packaging Code TR = Tape and Reel
---	---	---	---	--	--	---

Not RoHS Compliant



For RoHS compliant products, please select correct termination style.

****RoHS compliant**

QUALITY INSPECTION

Finished parts are 100% tested for electrical parameters and visual characteristics. Each production lot is evaluated on a sample basis for:

- Static Humidity: 85°C, 85% RH, 160 hours
- Endurance: 125°C, I_R, 4 hours

TERMINATION

Nickel/Solder coating (Sn, Pb) compatible with automatic soldering technologies: reflow, wave soldering, vapor phase and manual.

Recommended Pad Layout Dimensions mm (inches)

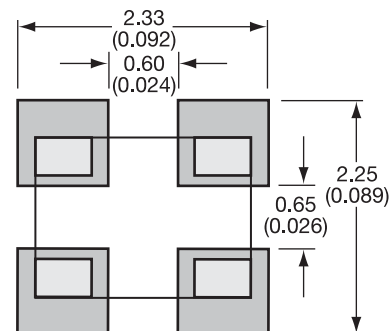

NOTE: Components must be mounted on the board with the white (Alumina) side DOWN.

Thin-Film RF/Microwave Directional Couplers

CP0302/CP0402/CP0603/CP0805 and DB0603N/DB0805 3dB 90°

CP0805 Layout Types

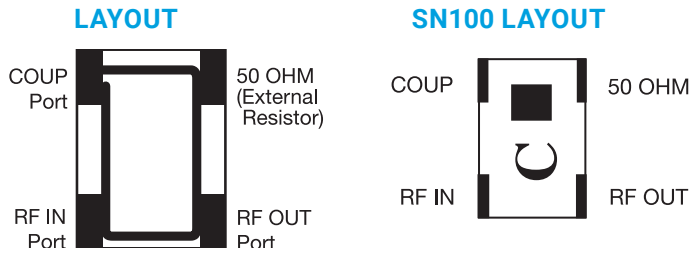

**Type: A
Sub-Type: A**

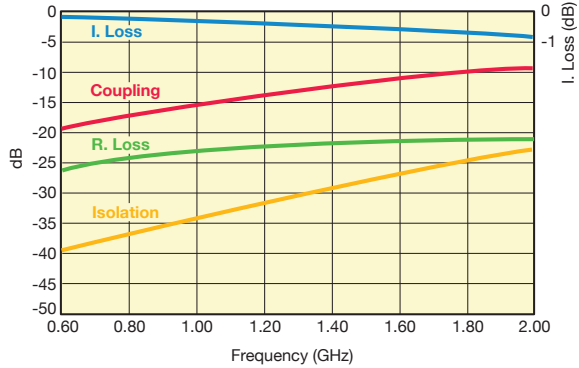

P/N Examples	Frequency Band [MHz]	Coupling [dB]	I. Loss max	VSWR max
CP0805A0836AS	824 - 849	16.5±1	0.25	1.2
CP0805A0881AS	869 - 894	16±1	0.25	1.2
CP0805A0902AS	890 - 915	16±1	0.25	1.2
CP0805A0947AS	935 - 960	15.5±1	0.25	1.2
CP0805A0897AS	880 - 915	16±1	0.25	1.2
CP0805A0942AS	925 - 960	15.5±1	0.25	1.2
CP0805A1441AS	1429 - 1453	12±1	0.5	1.3
CP0805A1747AS	1710 - 1785	10.5±1	0.7	1.4
CP0805A1842AS	1805 - 1880	10±1	0.8	1.4
CP0805A1880AS	1850 - 1910	9.5±1	0.8	1.4
CP0805A1960AS	1930 - 1990	9.5±1	0.8	1.4
CP0805A1907AS	1895 - 1920	9.5±1	0.8	1.4
CP0805A1890AS	1880 - 1900	9.5±1	0.8	1.4

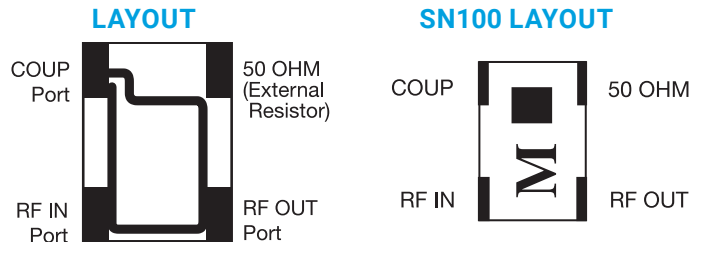

**Type: A
Sub-Type: B**

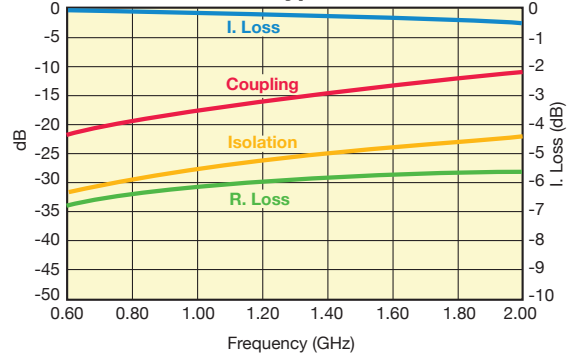

P/N Examples	Frequency Band [MHz]	Coupling [dB]	I. Loss max	VSWR max
CP0805A0836BS	824 - 849	19±1	0.25	1.2
CP0805A0881BS	869 - 894	18.5±1	0.25	1.2
CP0805A0902BS	890 - 915	18±1	0.25	1.2
CP0805A0947BS	935 - 960	18±1	0.25	1.2
CP0805A0897BS	880 - 915	18.5±1	0.25	1.2
CP0805A0942BS	925 - 960	18±1	0.25	1.2
CP0805A1441BS	1429 - 1453	14.5±1	0.35	1.2
CP0805A1747BS	1710 - 1785	12.5±1	0.5	1.4
CP0805A1842BS	1805 - 1880	12.5±1	0.5	1.4
CP0805A1880BS	1850 - 1910	12±1	0.6	1.4
CP0805A1960BS	1930 - 1990	11.5±1	0.7	1.4
CP0805A1907BS	1895 - 1920	12±1	0.6	1.4
CP0805A1890BS	1880 - 1900	12±1	0.6	1.4
CP0805A2442BS	2400 - 2484	10±1	0.9	1.4

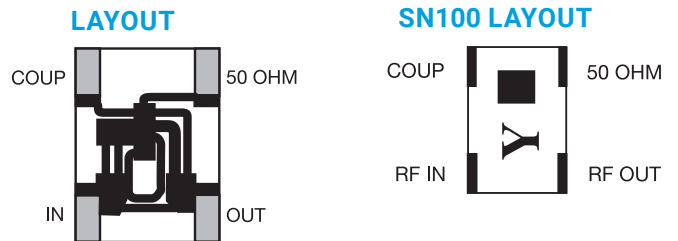

**Type: A
Sub-Type: C**

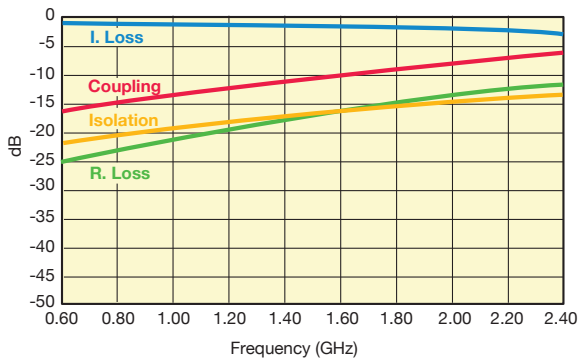

P/N Examples	Frequency Band [MHz]	Coupling [dB]	I. Loss max	VSWR max
CP0805A0836CS	824 - 849	14±1	0.5	1.4
CP0805A0881CS	869 - 894	13.5±1	0.5	1.4
CP0805A0902CS	890 - 915	13.5±1	0.5	1.4
CP0805A0947CS	935 - 960	13±1	0.5	1.4
CP0805A0897CS	880 - 915	13.5±1	0.5	1.4
CP0805A0942CS	925 - 960	13±1	0.5	1.4
CP0805A1441CS	1429 - 1453	9.5±1	1.15	1.8
CP0805A1747CS	1710 - 1785	8±1	1.6	2.2
CP0805A1842CS	1805 - 1880	8±1	1.6	2.2
CP0805A1880CS	1850 - 1910	7.5±1	1.75	2.2
CP0805A1960CS	1930 - 1990	7.5±1	1.75	2.2
CP0805A1907CS	1895 - 1920	7.5±1	1.75	2.2
CP0805A1890CS	1880 - 1900	7.5±1	1.75	2.2
CP0805A2442CS	2400 - 2484	6±1	2.5	2.2

Important: Couplers can be used at any frequency within the indicated range.



The Important Information/Disclaimer is incorporated in the catalog where these specifications came from or available online at www.avx.com/disclaimer/ by reference and should be reviewed in full before placing any order.

Thin-Film RF/Microwave Directional Couplers

CP0302/CP0402/CP0603/CP0805 and DB0603N/DB0805 3dB 90°

CP0805 Layout Types



LAYOUT

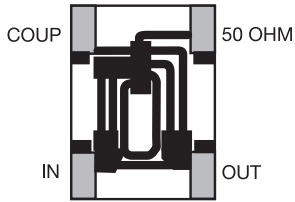

SN100 LAYOUT

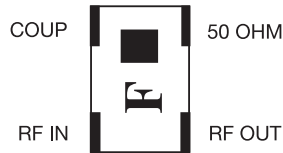

**Type: A
Sub-Type: D**

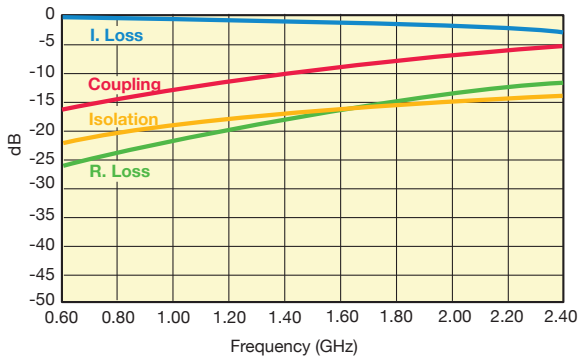

P/N Examples	Frequency Band [MHz]	Coupling [dB]	I. Loss max	VSWR max
CP0805A0836DS	824 - 849	13.0±1	0.5	1.4
CP0805A0881DS	869 - 894	12.5±1	0.5	1.4
CP0805A0902DS	890 - 915	12.5±1	0.5	1.4
CP0805A0947DS	935 - 960	12±1	0.5	1.4
CP0805A0897DS	880 - 915	12.5±1	0.5	1.4
CP0805A0942DS	925 - 960	12±1	0.5	1.4
CP0805A1441DS	1429 - 1453	8.5±1	1.25	1.8
CP0805A1747DS	1710 - 1785	7±1	1.85	1.8
CP0805A1842DS	1805 - 1880	7±1	1.85	1.8
CP0805A1880DS	1850 - 1910	7±1	1.85	1.8
CP0805A1960DS	1930 - 1990	6.5±1	2.15	2.1
CP0805A1907DS	1895 - 1920	6.5±1	2.15	2.1
CP0805A1890DS	1880 - 1900	7±1	1.85	1.8
CP0805A2442DS	2400 - 2484	5.5±1	2.4	2.1

LAYOUT

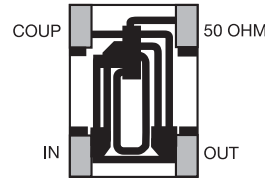

SN100 LAYOUT

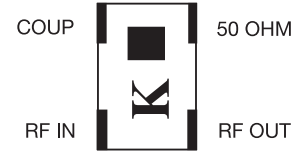

**Type: A
Sub-Type: E**

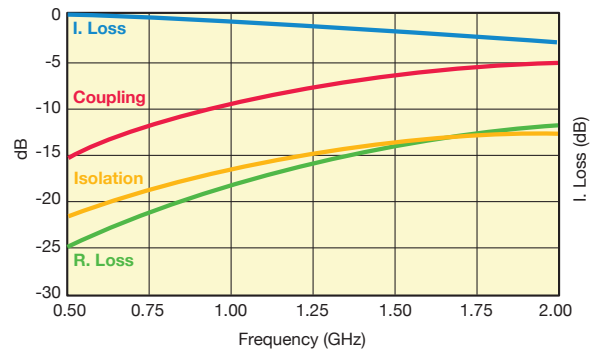

P/N Examples	Frequency Band [MHz]	Coupling [dB]	I. Loss max	VSWR max
CP0805A0836ES	824 - 849	11±1	0.85	1.4
CP0805A0881ES	869 - 894	10.5±1	0.85	1.4
CP0805A0902ES	890 - 915	10.5±1	0.85	1.4
CP0805A0947ES	935 - 960	10±1	0.85	1.4
CP0805A0897ES	880 - 915	10.5±1	0.85	1.4
CP0805A0942ES	925 - 960	10±1	0.85	1.4
CP0805A1441ES	1429 - 1453	7±1	1.8	1.8
CP0805A1747ES	1710 - 1785	5.5±1	2.7	2.2
CP0805A1842ES	1805 - 1880	5.5±1	2.7	2.2
CP0805A1880ES	1850 - 1910	5±1	3.15	2.4
CP0805A1960ES	1930 - 1990	5±1	3.15	2.4
CP0805A1907ES	1895 - 1920	5±1	3.15	2.4
CP0805A1890ES	1880 - 1900	5±1	3.15	2.4
CP0805A2442ES	2400 - 2484	4±1	4.2	2.4

Important: Couplers can be used at any frequency within the indicated range.

Thin-Film RF/Microwave Directional Couplers

CP0302/CP0402/CP0603/CP0805 and DB0603N/DB0805 3dB 90°

CP0805 Layout Types

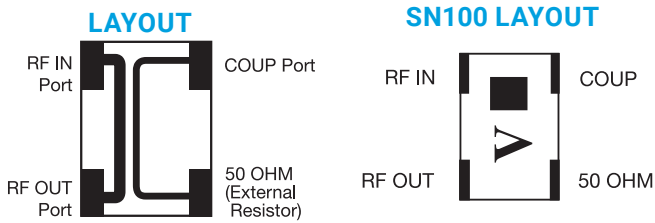

**Type: B
Sub-Type: B**

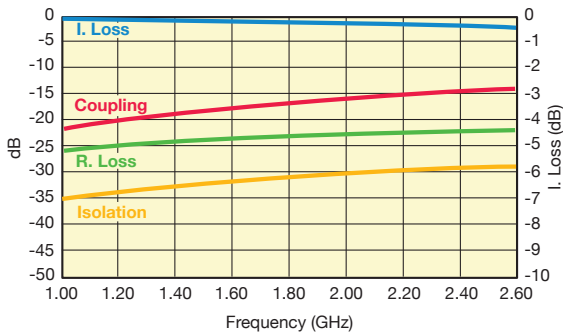

P/N Examples	Frequency Band [MHz]	Coupling [dB]	I. Loss max	VSWR max
CP0805B0836BS	824 - 849	23.5±1	0.25	1.2
CP0805B0881BS	869 - 894	23±1	0.25	1.2
CP0805B0902BS	890 - 915	22.5±1	0.25	1.2
CP0805B0947BS	935 - 960	22±1	0.25	1.2
CP0805B0897BS	880 - 915	23±1	0.25	1.2
CP0805B0942BS	925 - 960	22±1	0.25	1.2
CP0805B1441BS	1429 - 1453	18.5±1	0.25	1.2
CP0805B1747BS	1710 - 1785	17±1	0.25	1.2
CP0805B1842BS	1805 - 1880	16.5±1	0.25	1.2
CP0805B1880BS	1850 - 1910	16.5±1	0.25	1.2
CP0805B1960BS	1930 - 1990	16±1	0.25	1.2
CP0805B1907BS	1895 - 1920	16±1	0.25	1.2
CP0805B1890BS	1880 - 1900	16±1	0.25	1.2
CP0805B2442BS	2400 - 2484	14±1	0.4	1.2

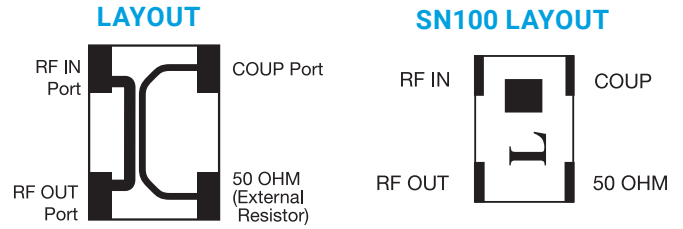

**Type: B
Sub-Type: C**

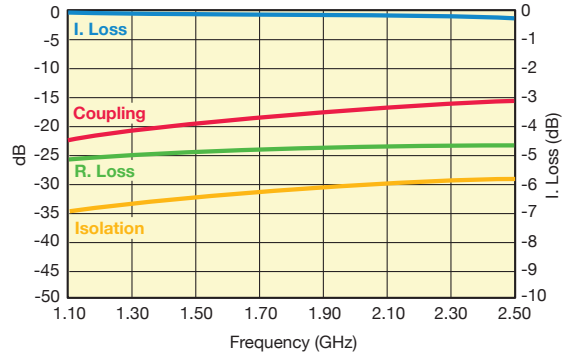

P/N Examples	Frequency Band [MHz]	Coupling [dB]	I. Loss max	VSWR max
CP0805B0836CS	824 - 849	25±1	0.25	1.2
CP0805B0881CS	869 - 894	24.5±1	0.25	1.2
CP0805B0902CS	890 - 915	24±1	0.25	1.2
CP0805B0947CS	935 - 960	24±1	0.25	1.2
CP0805B0897CS	880 - 915	24.5±1	0.25	1.2
CP0805B0942CS	925 - 960	24±1	0.25	1.2
CP0805B1441CS	1429 - 1453	20±1	0.25	1.2
CP0805B1747CS	1710 - 1785	18.5±1	0.25	1.2
CP0805B1842CS	1805 - 1880	18.5±1	0.25	1.2
CP0805B1880CS	1850 - 1910	18±1	0.25	1.2
CP0805B1960CS	1930 - 1990	17.5±1	0.25	1.2
CP0805B1907CS	1895 - 1920	18±1	0.25	1.2
CP0805B1890CS	1880 - 1900	18±1	0.25	1.2
CP0805B2442CS	2400 - 2484	16±1	0.4	1.2

**Type: B
Sub-Type: B**

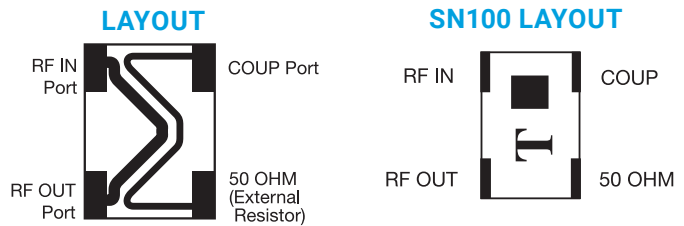
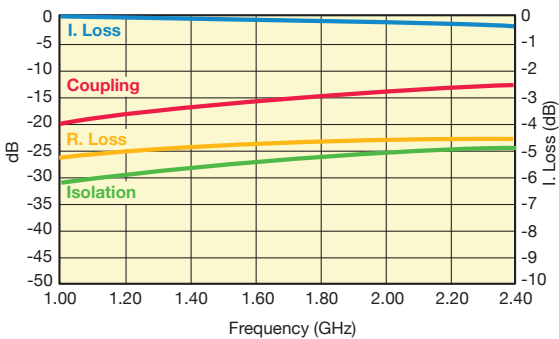

P/N Examples	Frequency Band [MHz]	Coupling [dB]	I. Loss max	VSWR max
CP0805B0836AS	824 - 849	21.5±1	0.25	1.2
CP0805B0881AS	869 - 894	21±1	0.25	1.2
CP0805B0902AS	890 - 915	21±1	0.25	1.2
CP0805B0947AS	935 - 960	20.5±1	0.25	1.2
CP0805B0897AS	880 - 915	21±1	0.25	1.2
CP0805B0942AS	925 - 960	20.5±1	0.25	1.2
CP0805B1441AS	1429 - 1453	17±1	0.25	1.2
CP0805B1747AS	1710 - 1785	15.5±1	0.25	1.2
CP0805B1842AS	1805 - 1880	15.5±1	0.3	1.2
CP0805B1880AS	1850 - 1910	15±1	0.3	1.2
CP0805B1960AS	1930 - 1990	14.5±1	0.4	1.2
CP0805B1907AS	1895 - 1920	15±1	0.3	1.2
CP0805B1890AS	1880 - 1900	15±1	0.3	1.2
CP0805B2442AS	2400 - 2484	13±1	0.4	1.2

Important: Couplers can be used at any frequency within the indicated range.

Thin-Film RF/Microwave Directional Couplers

CP0302/CP0402/CP0603/CP0805 and DB0603N/DB0805 3dB 90°

CP0805 Layout Types



VHF DIRECTIONAL COUPLER CP0805L0155ASTR SN100 LAYOUT

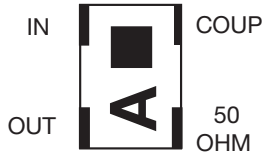

P/N	Frequency [MHz]	Coupling [dB]	R. Loss [dB]	I. Loss max [dB]	Directivity [dB]
CP0805L0155ASTR	155	17.1±1	24	0.35	22

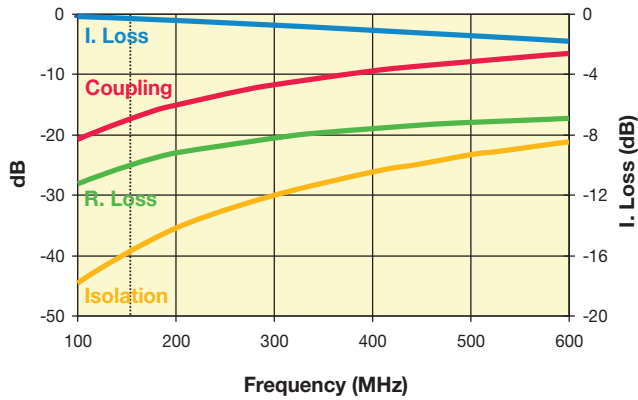

UHF DIRECTIONAL COUPLER CP0805L0436BSTR SN100 LAYOUT



P/N	Frequency [MHz]	Coupling [dB]	R. Loss [dB]	I. Loss max [dB]	Directivity [dB]
CP0805L0436BSTR	403-470	15.85±1	35	0.25	22

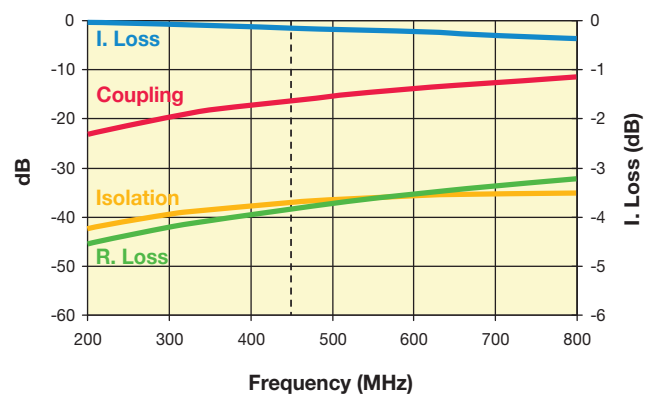

Important: Couplers can be used at any frequency within the indicated range.

Thin-Film RF/Microwave Directional Couplers

CP0302/CP0402/CP0603/CP0805 and DB0603N/DB0805 3dB 90°

CP0805 and CP0603 Test Jig



ITF TEST JIG FOR COUPLER TYPES 0805 AND 0603 SMD

GENERAL DESCRIPTION

This jig is designed for the testing of CP0805 and CP0603 series Directional Couplers using a vector network analyzer.

It consists of a FR4 multi-layer substrate, having 50Ω microstrips as conducting lines and a ground plane in the middle layer, located at a distance of 0.2mm from the microstrips.

The connectors are SMA type (female), 'Johnson Components Inc.' Product P/N: 142-0701-881.

The jig is designed for a full 2-port calibration. LOAD calibration can be done either by a 50Ω SMA termination, or by soldering a 50Ω chip resistor at the 50Ω ports.

MEASUREMENT PROCEDURE

When measuring a component, it can be either soldered or pressed by a non-metallic stick until all four ports touch the appropriate pads. To measure the coupling (and the R. Loss) place the component on the Port 1 & Port 2 pads. Use two SMA 50Ω terminations (male) to terminate the ports, which are not connected to the network analyzer, and connect the network analyzer to the two ports. A 90° rotation of the component on its pads allows measuring a second parameter (I. Loss).

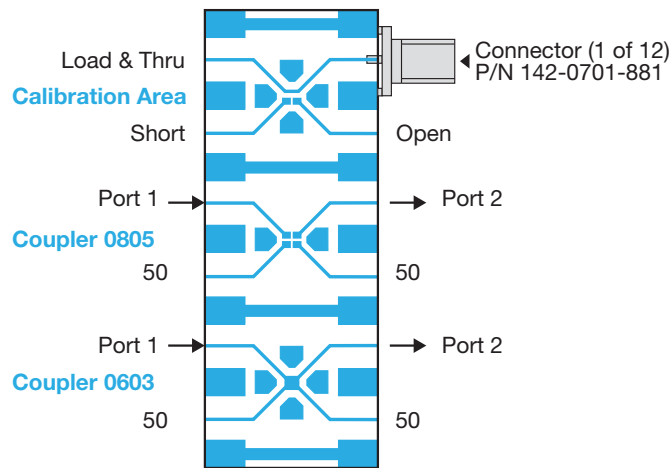

CP0805 SERIES DIRECTIONAL COUPLERS

Orientation and Tape and Reel Packaging Specification

(Top View)

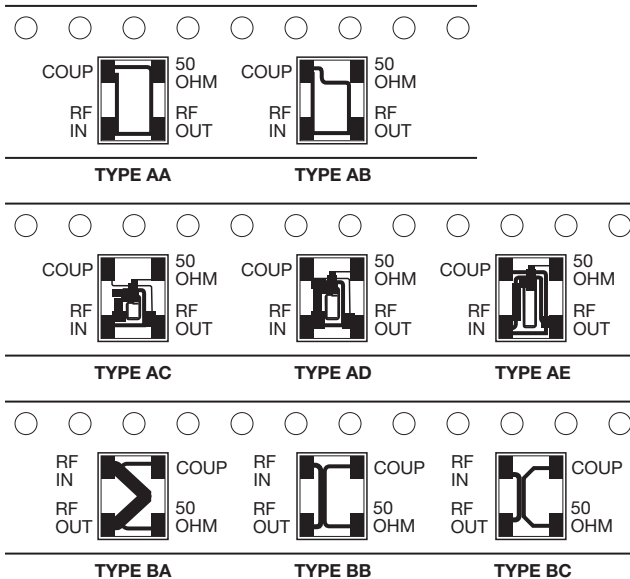

The parts should be mounted on the PCB with White (Alumina) side down and the "dark" side up.

CP0805xxxxxxSTR (Sn100)

(Top View)

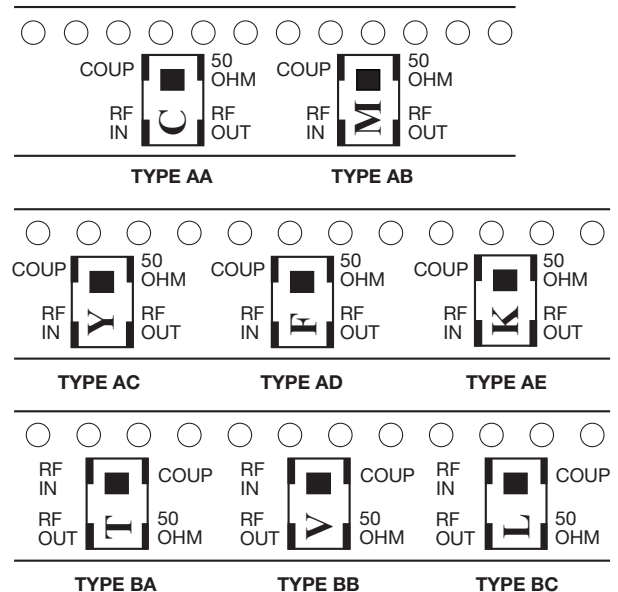

The parts should be mounted on the PCB with printed side up.



The Important Information/Disclaimer is incorporated in the catalog where these specifications came from or available online at www.avx.com/disclaimer/ by reference and should be reviewed in full before placing any order.