



Non-magnetic Surface Mount & Ribbon Leaded MLC Capacitors



Non-magnetic MLCC Ranges

The use of a copper barrier instead of a nickel barrier, with a tin finish on top, is the solution Knowles has developed for non-magnetic applications.

This non-magnetic termination is offered with selected non-magnetic High Q (COG/NPO), X5R and X7R dielectrics, providing a fully non-magnetic component ($\mu_r=1.0000$).

To meet high temperature 260°C soldering reflow profiles as detailed in J-STD-020, High Q dielectrics are supplied with sintered solder terminations, while X5R and X7R dielectrics use Knowles' award-winning FlexiCap™ solder termination.

Palladium silver termination for conductive epoxy mounting is also available for parts in the High Q Standard range and X5R/X7R ranges.

Ribbon lead terminations for optimum mechanical performance are available on High Q High Power RF parts.

Electrical Details		
Capacitance Range		0.2pF to 6.8μF
Temperature Coefficient of Capacitance (TCC)	High Q (COG/NPO)	0 ± 30ppm/°C
	X5R	±15% from -55°C to +85°C
	X7R	±15% from -55°C to +125°C
Dissipation Factor	High Q (COG/NPO) Surface mount	≤ 0.0014 for capacitance values <10pF ≤ 0.00067 for capacitance values ≥10pF
	High Q (COG/NPO) Ribbon	≤ 0.0005
	X5R and X7R	≤ 0.025 for rated voltages >25V ≤ 0.035 for rated voltages ≤25V
Minimum Insulation Resistance (IR)		100GΩ or (1000s/cap in F), whichever is less
Dielectric Withstand Voltage (DWV)		Voltage applied for 5 seconds maximum, at 50mA maximum charging current
Ageing Rate	High Q (COG/NPO)	Zero
	X5R and X7R	<2% per time decade

Surface Mount MLCC Dimensions

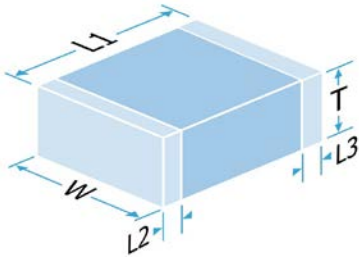

High Q (COG/NPO) Standard Range

Size	Length (L1) mm/inches	Width (W) mm/inches	Max. Thickness (T) mm/inches	Termination Band (L2, L3) mm/inches	
				min	max
0402	1.0 ± 0.10	0.52 ± 0.12	0.64	0.10	0.40
	0.04 ± 0.004	0.02 ± 0.005	0.025	0.004	0.016
0603	1.6 ± 0.2	0.8 ± 0.2	0.80	0.20	0.40
	0.063 ± 0.008	0.032 ± 0.008	0.032	0.008	0.016
0505	1.4 + 0.35 - 0.25	1.4 ± 0.25	1.27	0.13	0.50
	0.055 + 0.014 - 0.01	0.055 ± 0.01	0.050	0.005	0.020
0805	2.0 ± 0.3	1.25 ± 0.2	1.3	0.25	0.75
	0.079 ± 0.012	0.049 ± 0.008	0.051	0.01	0.03
1206	3.2 + 0.20/-0.30	1.6 ± 0.2	1.7	0.25	0.75
	0.126 + 0.008/-0.012	0.063 ± 0.008	0.068	0.01	0.03
1210	3.2 + 0.20/-0.30	2.5 ± 0.3	2.0	0.25	0.75
	0.126 + 0.008/-0.012	0.098 ± 0.012	0.08	0.01	0.03
1808	4.5 ± 0.35	2.0 ± 0.3	2.0	0.25	1.0
	0.18 ± 0.014	0.08 ± 0.012	0.08	0.01	0.04
1812	4.5 ± 0.35	3.2 ± 0.3	2.5	0.25	1.143
	0.18 ± 0.014	0.126 ± 0.012	0.10	0.01	0.045
2220	5.7 ± 0.4	5.0 ± 0.4	2.5	0.25	1.0
	0.225 ± 0.016	0.197 ± 0.016	0.10	0.01	0.04

High Q (COG/NPO) High Power RF Range

Size	Length (L1) mm/inches	Width (W) mm/inches	Thickness (T) mm/inches	Termination Band (L2, L3) mm/inches	
				min	max
1111	2.79 + 0.51/-0.25	2.79 ± 0.38	2.0 ± 0.2*	0.13	0.63
	0.110 + 0.020/-0.010	0.113 ± 0.015	0.08 ± 0.008*	0.005	0.025
2225	5.7 ± 0.4	6.3 ± 0.4	4.0 max	0.25	1.0
	0.225 ± 0.016	0.252 ± 0.016	0.157 max	0.01	0.04
4040	10.2 ± 0.508	10.2 ± 0.508	5.0 max	0.50	1.5
	0.400 ± 0.020	0.400 ± 0.020	0.197 max	0.02	0.06

* For capacitance values ≤2pF, thickness of case size 1111 is 1.78mm (0.07") max



X5R and X7R Ranges

Size	Length* (L1) mm/inches	Width (W) mm/inches	Max. Thickness (T) mm/inches	Termination Band (L2, L3) mm/inches	
				min	max
0402	1.0 +0.20/-0.10	0.52 ± 0.12	0.64	0.10	0.40
	0.04 +0.008/-0.004	0.02 ± 0.005	0.025	0.004	0.016
0603	1.6 +0.25/-0.15	0.8 ± 0.15	0.80	0.20	0.40
	0.063 +0.010/-0.006	0.032 ± 0.006	0.032	0.008	0.016
0805	2.0 +0.3/-0.2	1.25 ± 0.2	1.3	0.25	0.75
	0.079 +0.012/-0.008	0.049 ± 0.008	0.051	0.01	0.03
1206	3.2 +0.30/-0.20	1.6 ± 0.2	1.7	0.25	0.75
	0.126 +0.012/-0.008	0.063 ± 0.008	0.068	0.01	0.03
1210	3.2 +0.30/-0.20	2.5 ± 0.2	2.0	0.25	0.75
	0.126 +0.012/-0.008	0.098 ± 0.008	0.08	0.01	0.03
1808	4.5 +0.45/-0.35	2.0 ± 0.3	2.0	0.25	1.0
	0.180 +0.018/-0.014	0.08 ± 0.012	0.08	0.01	0.04
1812	4.5 +0.40/-0.30	3.2 ± 0.2	2.5	0.25	1.143
	0.180 +0.016/-0.012	0.126 ± 0.008	0.10	0.01	0.045
2220	5.7 +0.5/-0.4	5.0 ± 0.4	2.5	0.25	1.0
	0.225 +0.020/-0.016	0.197 ± 0.016	0.10	0.01	0.04
2225	5.7 +0.5/-0.4	6.3 ± 0.4	2.5	0.25	1.143
	0.225 +0.020/-0.016	0.252 ± 0.016	0.10	0.01	0.045

*Length data shown is for FlexiCap™ termination (termination codes 3,5). For palladium silver termination (termination code F), subtract 0.1mm (0.004") from maximum length. For example, length of 0402 with F termination is 1.0 ±0.10mm (0.04 ±0.004mm).

Ribbon Ledged MLCC Dimensions

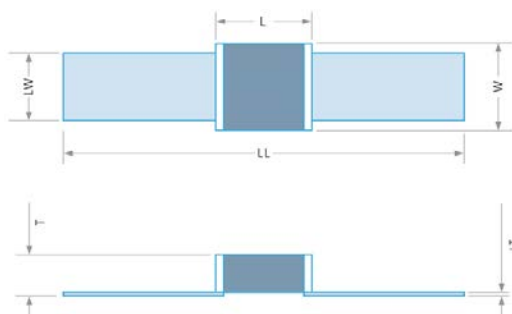

Silver plated copper ribbon attached with HMP solder (MP greater than 260°C)

Ribbon ledged format is available for High Q (COG/NPO) High Power RF Range only

Size	Length (L) mm/inches	Width (W) mm/inches	Thickness (T) mm/inches	Lead Length (LL) mm/in	Lead Width (LW) mm/in	Lead Thickness (LT) mm/in
1111	3.55 max	2.2 max	2.5 max	16 typ	2.36 ± 0.15	0.1 ± 0.02
	0.140 max	0.087 max	0.098 max	0.63 typ	0.093 ± 0.006	0.004 ± 0.0008
2225	9.3 max	7.5 max	4.4 max	35 typ	5.5 ± 0.5	0.25 +0.10/-0.05
	0.366 max	0.30 max	0.173 max	1.378 typ	0.22 ± 0.02	0.01 +0.004/-0.002
4040	12.0 max	11.5 max	5.6 Max	50 typ	8.9 ± 0.5	0.25 +0.10 / -0.05
	0.473 max	0.45 max	0.220 Max	1.97 typ	0.35 ± 0.02	0.01 +0.004/-0.002

Minimum/Maximum Capacitance Values

High Q (COG/NPO) Standard Range

Chip Size	0402	0603	0505	0805	1206	1210	1808	1812	2220
Min Cap	0.2pF	0.2pF	0.2pF	0.2pF	0.5pF	0.3pF	1.0pF	1.0pF	2.0pF
Min Cap Tolerance	±0.05pF (<10pF) and ±1% (≥10pF)								
50V/63V	22pF	100pF	220pF	470pF	1.5nF	-	-	-	-
100V	15pF	100pF	220pF	330pF	1.0nF	2.2nF	2.2nF	4.7nF	10nF
150V	10pF	82pF	220pF	220pF	680pF	1.5nF	1.5nF	3.3nF	6.8nF
200V/250V	6.8pF	68pF	100pF	150pF	470pF	1.0nF	1.0nF	2.2nF	4.7nF
300V	-	27pF	47pF	120pF	390pF	820pF	820pF	1.8nF	3.9nF
500V	-	-	-	68pF	270pF	680pF	680pF	1.5nF	3.3nF
630V	-	-	-	-	150pF	390pF	390pF	1.0nF	2.2nF
1000V	-	-	-	-	82pF	220pF	220pF	680pF	1.5nF
2000V	-	-	-	-	18pF	68pF	68pF	150pF	470pF
3000V	-	-	-	-	-	-	-	68pF	150pF

Minimum/Maximum Capacitance Values (Continued)

High Q (COG/NPO) High Power RF range

Chip Size	1111		2225		4040	
Min Cap Tolerance	±0.10pF (<10pF) and ±1% (≥10pF)					
	Min	Max	Min	Max	Min	Max
100V	1.6nF	2.2nF	-	-	-	-
150V	1.1nF	1.5nF	-	-	-	-
200V	-	-	-	-	-	-
250V	750pF	1nF	6.2nF	10nF	16nF	27nF
300V	510pF	680pF	-	-	-	-
500V	430pF	470pF	5.1nF	5.6nF	13nF	15nF
630V	240pF	390pF	3.6nF	4.7nF	11nF	12nF
1kV	110pF	220pF	1.1nF	3.3nF	5.6nF	10nF
1.5kV	75pF	100pF	-	-	-	-
2kV	0.4pF	68pF	510pF	1.0nF	1.6nF	5.1nF
3kV	-	-	110pF	470pF	910pF	1.5nF
3.6kV	-	-	1pF	47pF* /100pF	-	-
4kV	-	-	-	-	620pF	820pF
5kV	-	-	-	-	360pF	560pF
6kV	-	-	-	-	160pF	330pF
7kV / 7.2kV	-	-	-	-	1pF	56pF** /150pF

A range of ultra-low loss High Q ceramic capacitors with COG/NPO characteristics suitable for high power applications where minimal power loss and very low self-heating is demanded.

Common applications include MRI body coils and wireless charging systems operating in the kHz and MHz frequencies.

The High Q High Power RF range is available in chip or ribbon leaded format.

*2225 3.6kV: Values up to 47pF max. are dual rated 3.6kVdc / 2.5kVac @ 30MHz

**4040 7kV/7.2kV: Values up to 56pF max. are dual rated 7.0kV(7.2kV)dc / 5kVac @ 30MHz

X5R Range

Chip Size	0402	0603	0805	1206	1210	1808	1812	2220	2225
MinCap	47pF	100pF	330pF	680pF	1.5nF	2.2nF	3.3nF	6.8nF	10nF
Min Cap Tolerance	±5%								
16V	22nF	100nF	330nF	1.0µF	1.5µF	1.5µF	3.3µF	5.6µF	6.8µF
25V	15nF	100nF	330nF	1.0µF	1.2µF	1.2µF	2.2µF	4.7µF	5.6µF

X7R Range

Chip Size	0402	0603	0805	1206	1210	1808	1812	2220	2225
MinCap	47pF	100pF	330pF	680pF	1.5nF	2.2nF	3.3nF	6.8nF	10nF
Min Cap Tolerance	±5%								
50V/63V	10nF	100nF	150nF	470nF	1.0µF	680nF	1.5µF	3.3µF	3.3µF
100V	4.7nF	22nF	100nF	270nF	560nF	330nF	1.0µF	1.5µF	1.5µF
200V/250V	680pF	5.6nF	27nF	100nF	220nF	180nF	470nF	1.0µF	1.0µF
500V	-	1.5nF	8.2nF	33nF	100nF	100nF	270nF	560nF	680nF
630V	-	-	4.7nF	10nF	27nF	33nF	150nF	330nF	390nF
1000V	-	-	3.3nF	4.7nF	15nF	18nF	56nF	120nF	150nF
1200V	-	-	-	3.3nF	10nF	10nF	33nF	82nF	100nF
1500V	-	-	-	2.7nF	6.8nF	6.8nF	22nF	47nF	68nF
2000V	-	-	-	2.2nF	4.7nF	4.7nF	10nF	27nF	33nF

Ordering Information

Non-magnetic capacitors – Surface Mount - High Q Standard, X5R and X7R Ranges

1210	3	100	0103	J	X	T	□□□
Chip Size	Termination	Rated Voltage	Capacitance in Pico farads (pF)	Capacitance Tolerance	Dielectric Codes	Packaging	Suffix Code
0402 0505* 0603 0805 1206 1210 1808 1812 2220 2225**	<p>2 = Sintered silver base with copper barrier (100% matte tin plating). RoHS compliant. Available on High Q only.</p> <p>3 = FlexiCap™ base with copper barrier (100% matte tin plating). RoHS compliant. Available on X5R and X7R only.</p> <p>4 = Sintered silver base with copper barrier (tin/lead plating). Non RoHS compliant. Available on High Q only.</p> <p>5 = FlexiCap™ base with copper barrier (tin/lead plating). Non RoHS compliant. Available on X5R and X7R only.</p> <p>F = Palladium Silver for conductive epoxy mounting. Lead Free, RoHS compliant.</p>	<p>016 = 50V 025 = 50V 050 = 50V 063 = 63V 100 = 100V 150 = 150V 200 = 200V 250 = 250V 300 = 300V 500 = 500V 630 = 630V 1K0 = 1kV 1K2 = 1.2kV 1K5 = 1.5kV 2K0 = 2kV 3K0 = 3kV</p>	<p><10pF Insert a P for the decimal point as the second character. e.g., P300 = 0.3pF 8P20 = 8.2pF ≥10pF First digit is 0. Second and third digits are significant figures of capacitance code. The fourth digit is the number of zeros following. e.g., 0103 = 10000 pF Values <1pF in 0.1pF steps, above this values are E24 series</p>	<p><10pF H: ± 0.05pF B: ± 0.10pF C: ± 0.25pF D: ± 0.5pF ≥10pF F: ± 1% G: ± 2% J: ± 5% K: ± 10% M: ± 20%</p> <p>X5R and X7R parts are available in tolerances J,K,M only</p>	<p>Q = High Q (COG/NPO) P = X5R X = X7R (2R1)</p>	<p>T = 178mm (7") reel R = 330mm (13") reel B = Bulk pack – tubs or trays</p>	<p>LSM = SM standard with optional marking Also used for specific customer requirements</p>

* Case size 0505 is available in High Q dielectric only

** Case size 2225 is available in X7R and X5R dielectrics only

Non-magnetic capacitors – Surface Mount - High Q High Power RF Range

4040	2	7K0	0470	G	Q	B	AF9
Chip Size	Termination	Rated Voltage	Capacitance in Pico farads (pF)	Capacitance Tolerance	Dielectric Codes	Packaging	Suffix Code
1111 2225 4040	<p>2 = Sintered silver base with copper barrier (100% matte tin plating). RoHS compliant.</p> <p>4 = Sintered silver base with copper barrier (tin/lead plating). Non RoHS compliant.</p>	<p>100 = 100V 150 = 150V 200 = 200V 250 = 250V 300 = 300V 500 = 500V 630 = 630V 1K0 = 1kV 1K5 = 1.5kV 2K0 = 2kV 3K0 = 3kV 3K6 = 3.6kV 4K0 = 4kV 5K0 = 5kV 6K0 = 6kV 7K0 = 7kV / 7.2kV</p>	<p><10pF Insert a P for the decimal point as the second character. e.g., P300 = 0.3pF 8P20 = 8.2pF ≥10pF First digit is 0. Second and third digits are significant figures of capacitance code. The fourth digit is the number of zeros following. e.g., 0103 = 10000 pF Values <1pF in 0.1pF steps, above this values are E24 series</p>	<p><10pF B: ± 0.10pF C: ± 0.25pF D: ± 0.5pF ≥10pF F: ± 1% G: ± 2% J: ± 5% K: ± 10% M: ± 20%</p>	<p>Q = High Q (COG/NPO)</p>	<p>T* = 178mm (7") reel R = 330mm (13") reel B = Bulk pack – tubs or trays (*option T is available for 1111 and 2225 only)</p>	<p>AF9 = SM standard AF9LM = SM standard with optional marking Also used for specific customer requirements</p>

Non-magnetic capacitors – Ribbon Leded - High Q High Power RF Range

2225	V	3K0	6P80	G	Q	B	R	□□□□
Chip Size	Termination	Rated Voltage	Capacitance in Pico farads (pF)	Capacitance Tolerance	Dielectric Codes	Packaging	Lead Option	Suffix Code
1111 2225 4040	<p>B = Uncoated</p> <p>V = Coated with modified silicone lacquer</p>	<p>100 = 100V 150 = 150V 200 = 200V 250 = 250V 300 = 300V 500 = 500V 630 = 630V 1K0 = 1kV 1K5 = 1.5kV 2K0 = 2kV 3K0 = 3kV 3K6 = 3.6kV 4K0 = 4kV 5K0 = 5kV 6K0 = 6kV 7K0 = 7kV / 7.2kV</p>	<p><10pF Insert a P for the decimal point as the second character. e.g., P300 = 0.3pF 8P20 = 8.2pF ≥10pF First digit is 0. Second and third digits are significant figures of capacitance code. The fourth digit is the number of zeros following. e.g., 0103 = 10000 pF Values <1pF in 0.1pF steps, above this values are E24 series</p>	<p><10pF B: ± 0.10pF C: ± 0.25pF D: ± 0.5pF ≥10pF F: ± 1% G: ± 2% J: ± 5% K: ± 10% M: ± 20%</p>	<p>Q = High Q (COG/NPO)</p>	<p>B = Bulk pack – tubs or trays</p>	<p>R = Ribbon Lead</p>	<p>W211 = leaded and marked W221 = leaded / not marked (standard) Also used for specific customer requirements</p>

Reel Quantities for Non-magnetic Surface Mount MLCC Chip Sizes

Chip Size	0402	0505	0603	0805	1111	1206	1210	1808	1812	2220	2225	4040
7" Reel	10000	2500	4000	3000	1000	2500	2000	1500	500	500	500	-
13" Reel	15000	10000	16000	12000	5000	10000	8000	6000	2000	2000	2000	500

Note: Other capacitance values may become available, please contact our Sales Office if you need values other than those shown in the above tables.

For dimensions and soldering information, please go to our website (www.knowlescapacitors.com) or see our MLC catalogue.

Product Marking

Product marking is available on request for most parts by the addition of a suffix code – see ordering information for more details.

Marking is applied using either military grade, solvent-resistant ink, or by laser-etching the MLCC surface.

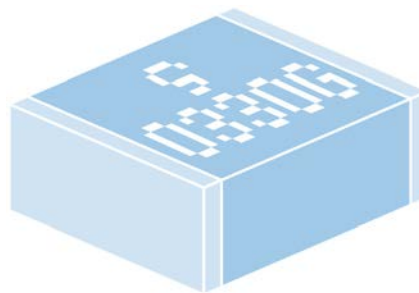
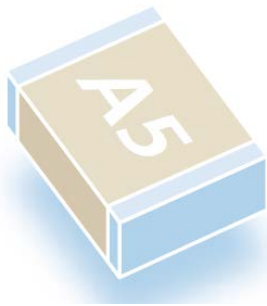

Smaller size components will be marked with a 2-digit code in accordance with EIA-198 marking requirements.

Larger size parts will include capacitance value and tolerance. Marking will be applied to either both top and bottom, or the top side of chip and will be visible when the component is mounted.

Please refer to the sales office for more information.

Datasheets and Environmental Certificates

Detailed individual datasheets and part specific environmental certificates can now be downloaded direct from the Knowles website (www.knowlesc capacitors.com):

Multilayer Ceramic Chip Capacitor

Part Number: 080525000680FQT **Description:** 0805 500V 68pF ±1% COG - HI Q/Low ESR Non-Mag

Ultra stable HighQ Low ESR multi-layer ceramic capacitors offering a very stable COG High Q material system that provides excellent low loss performance, and is non-magnetic with a guaranteed relative permeability of 1.000. Optimised for lowest possible ESR, the electrode system provides low metal losses resulting in flatter performance curves and reduced losses at higher frequencies.

AF9 suffix parts using palladium silver (PdAg) termination are unplated, suitable for mounting using conductive adhesive.

Mechanical Specification	
Size Code	0805
Length (L1) in mm (")	2.0 ± 0.30 (0.079 ± 0.012)
Width (W) in mm (")	1.25 ± 0.20 (0.049 ± 0.008)
Thickness (T) in mm (")	1.3 Max (0.051 Max)
Minimum Termination Band (L2,L3) in mm (")	0.25 (0.010)
Maximum Termination Band (L2,L3) in mm (")	0.75 (0.030)
Termination Material	Copper Barrier, Sn Plated Solder (Non-Mag., RoHS compliant)
Solderability	IEC-60065-2-58
Packaging	7" Reel Horizontal Orientation, 3000 per reel

General Electrical Specification	
Rated Voltage	500Vdc
Nominal Capacitance Value	68pF
Capacitance Tolerance	±1%
Tangent of Loss Angle (Tan δ)	≤0.00067
Capacitance and Tan δ Test Conditions	1.0Vrms @ 1MHz
Voltage Proof	750Vdc
<small>(Voltage applied for 5 secs max. @ 50V/Max. charge current)</small>	
Min Insulation Resistance (IR)	100.00GΩhm @ 100Vdc
Dielectric Classification	COG - HI Q/Low ESR Non-Mag
Rated Temperature Range	-55°C / +125°C
Maximum Capacitance Change over Temperature Range	No DC Voltage 0±30ppm/°C
Climate Category (IEC)	Rated DC Voltage -
Ageing Characteristic	55/125/58
	Zero

Knowles Precision Devices - Sales
 Europe: KPD-Europe-sales@knowles.com
 Asia: KPD-Asia-sales@knowles.com
 USA: KPD-NA-sales@knowles.com
www.knowlesc capacitors.com

This datasheet is for a standard item and is confirmed valid on the date generated, the latest published data for this part may differ and is available at <http://www.knowlesc capacitors.com> or by contacting us.

All the information contained on this drawing is confidential and may not be copied in whole or part in any form or disclosed to a third party without the consent of Knowles and any customer mentioned within this specification.

Data is correct to the best of our knowledge, errors and omissions excepted.

Date: Monday, May 11, 2020

Certificate of RoHS Compliance, REACH Compliance and WEEE Statement

Part Number: 080525000680FQT **Description:** 0805 500V 68pF ±1% COG - HI Q/Low ESR Non-Mag

EU RoHS

Knowles hereby certifies that the part number stated on this certificate complies with the legislative requirements as defined in the RoHS Directive 2011/65/EU (as amended by 2015/863/EU).

There are no exemptions used on these parts to achieve compliance.

China RoHS

In line with the requirements of China RoHS, the hazardous substances table is shown below. In line with the legislative requirements, Knowles will supply a copy of this hazardous substance table with each shipment of product.

Hazardous Substances 有害物质					
Lead (Pb) 铅	Mercury (Hg) 汞	Cadmium (Cd) 镉	Hexavalent Chromium (Cr(VI)) 六价铬	Polybrominated biphenyls (PBB) 多溴联苯	Polybrominated diphenyl ethers (PBDE) 多溴二苯醚
○	○	○	○	○	○

本表格依据SJ/T 11364 的规定编制 This table is prepared in accordance with the provisions of SJ/T 11364

○ : 表示该有害物质在该部件所有均质材料中的含量均在GB/T 26572 规定的限量要求以下。

○ : Indicates that said hazardous substance contained in all of the homogeneous materials for this part is below the limit requirement of GB/T 26572.

× : 表示该有害物质至少在该部件的某一均质材料中的含量超出GB/T 26572 规定的限量要求。

× : Indicates that said hazardous substance contained in at least one of the homogeneous materials used for this part is above the limit requirement of GB/T 26572.

Knowles Precision Devices - Sales
 Europe: KCN-KC-CS@knowles.com
 Asia: KPD-Asia-sales@knowles.com
 USA: KPD-NA-sales@knowles.com
www.knowlesc capacitors.com

Data is correct to the best of our knowledge, errors and omissions excepted.

Date: Monday, May 11, 2020

Knowles Precision Devices Sales contact e-mail	Europe:	KPD-Europe-sales@knowles.com
	Asia:	KPD-Asia-sales@knowles.com
	USA:	KPD-NA-sales@knowles.com

To generate the datasheet or environmental certificate for a part:

- If you know the part number, use the **MLC Part Search** application to search for the part, then choose Datasheet or Environmental Certificate in the Actions column:

Search Part Number
Hint: Use wild cards ? for single character and * for all. Example: 0?804*

080525000680FQT Search

Show 10 entries

Part Number	Brand	Family	Description	Actions
080525000680FQT	Syfer	SMD Capacitors / Non-Magnetic / High Q	0805 500V, 68pF, ±1%, COG - HI Q/Low ESR Non-Mag, Copper Barrier, Sn Plated Solder (Non-Mag., RoHS compliant), 7" Reel Horizontal Orientation	Datasheet Env Cert Check Stock

- If you don't know the part number, use the **MLC Part Builder** application to specify the required properties (case size, termination, rated voltage, capacitance value, etc.), then click the Actions button to generate the Datasheet or Environmental Certificate:

Part Builder
SMD Capacitors > Non-Magnetic > High Q

Select Product: SMD Capacitors Select Product Type: Non-Magnetic Select Range: High Q

Part # 0805 2 500 0680 F Q T Reel Copy Syfer

Case Size	Termination	Voltage	Capacitance	Tolerance	Dielectric	Packaging	Actions
0805 0.079" x 0.049" (2.0mm x 1.25mm)	2 Copper Barrier, Sn Plated Solder (Non-Mag., RoHS compliant)	500 500V	680 68pF	F ±1%	Q COG - HI Q/Low ESR Non-Mag	7" Reel Horizontal Orientation	Datasheet Environmental Certificates Request a Quote Request a Sample Check Stock
0402 0.54" x 0.02" (1.0mm x 0.52mm)	4 Copper Barrier 30/10% Sn/Pb (Contains Lead - Non-RoHS)	050 50V	0300 30pF	G ±2%		8 Bulk	
0605 0.056" x 0.056" (1.4mm x 1.4mm)	F Palladium Silver (Lead Free, RoHS compliant)	063 63V	0300 30pF	J ±5%		8 13" Reel	
0803 0.062" x 0.032" (1.6mm x 0.8mm)		100 100V	0430 43pF	K ±10%			
1206 0.126" x 0.063" (3.2mm x 1.6mm)		150 150V	0470 47pF	M ±20%			

Typical Example Performance Curves

High Q Standard Surface Mount MLCCs

Typical performance data - 0505 chip size

Typical performance data - 1111 chip size

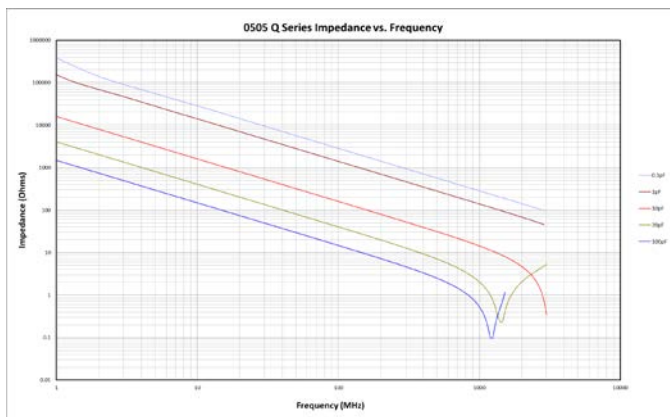
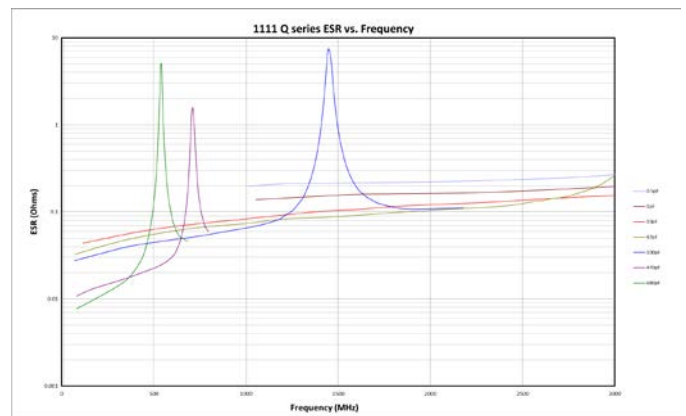
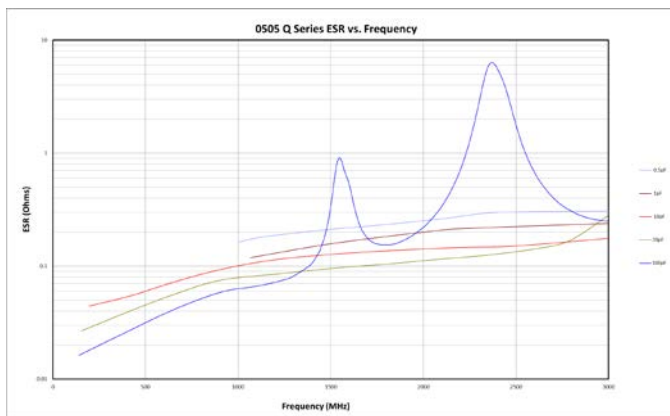
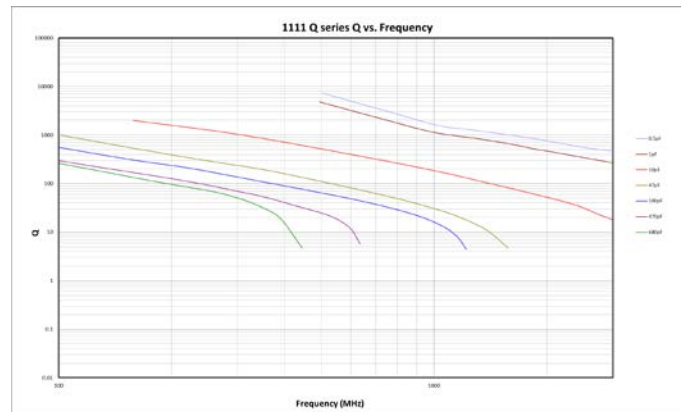
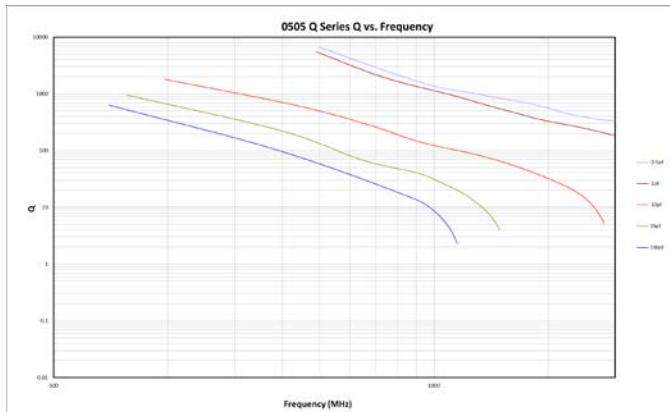

ESR Measurement

All ESR figures for high power and ribbon components are based on measurements taken with Boonton 34A resonant tube, Agilent E4991A impedance analyser and Agilent 16197A test fixture.

Different test methods or fixtures may give different results. Data is typical and is supplied for indication only.

Typical Example Performance Curves (Continued)

High Q High Power Surface Mount and Ribbon Led MLCCs

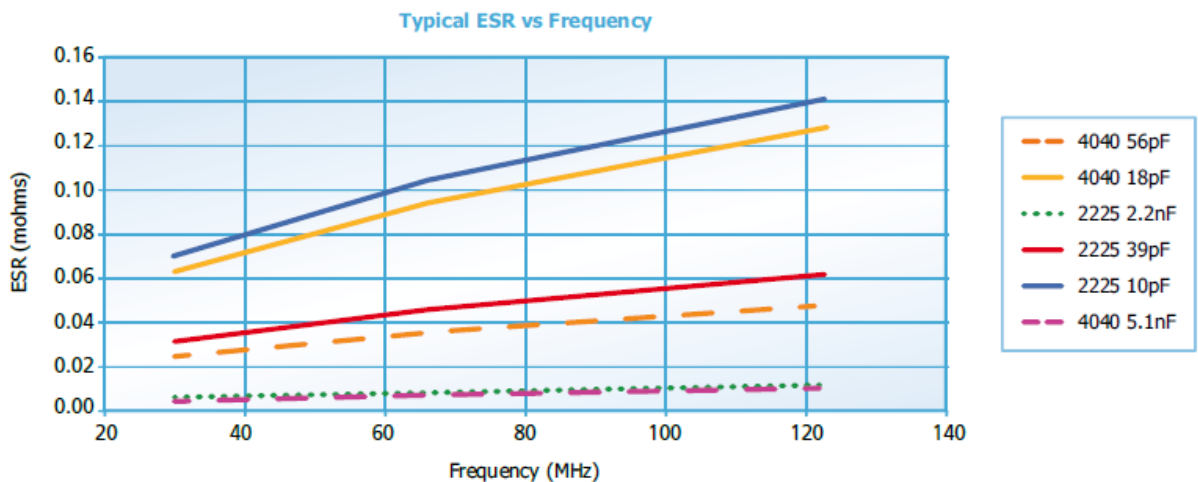

ESR Measurement

All ESR figures for high power and ribbon components are measured using a VNA and 2m copper resonant tube and extrapolating to 30MHz by ratio. Measured data can be supplied on request. Measurement of ESR can vary with test method and components should only be compared when tested back-to-back on the same equipment under controlled conditions.

Performance and Testing

	High Q (COG/NPO)			X5R	X7R		
	Ultra-stable			Stable	Stable		
IECQ-CECC	1B/CG	-	-	-	2C1	2R1	2X1
EIA	-	COG/NPO	-	X5R	-	X7R	-
MIL	-	-	CG (BP)	-	BZ	-	BX
Rated temperature range	-55°C to +125°C			-55°C to +85°C	-55°C to +125°C		
Maximum capacitance change over temperature range	0 ± 30 ppm/°C			± 15%	± 20%	± 15%	± 15%
Rated DC voltage applied				-	+20 -30%	-	+15 -25%
Knowles / Syfer dielectric ordering code	Q			P	R	X	B
Tangent of loss angle (tan δ)	Surface mount ≤ 0.0014 for cap values <10pF ≤ 0.00067 for cap values ≥10pF Ribbon ≤ 0.0005 @ 1MHz (Cr ≤ 1nF) or 1kHz (Cr > 1nF)			≤ 0.025 for rated voltages >25V ≤ 0.035 for rated voltages ≤25V @1kHz	≤ 0.025 for rated voltages >25V ≤ 0.035 for rated voltages ≤25V @1kHz		
Minimum Insulation resistance (RI)	100GΩ or (1000s/cap value in F) - whichever is less			100GΩ or (1000s/cap value in F) - whichever is less	100GΩ or (1000s/cap value in F) - whichever is less		
Capacitance tolerance (ordering code)	Cr <10pF	± 0.05pF (H) ± 0.10pF (B) ± 0.25pF (C) ± 0.50pF (D)		± 5% (J) ± 10% (K) ± 20% (M)	± 5% (J) ± 10% (K) ± 20% (M)		
	Cr ≥10pF	± 1% (F) ± 2% (G) ± 5% (J) ± 10% (K) ± 20% (M)					
Dielectric strength	Voltage applied for 5 seconds max. Charging current limited to 50mA maximum.						
≤200V	2.5 times			2.5 times	2.5 times		
>200V to <500V	Rated voltage + 250V			Rated voltage + 250V	Rated voltage + 250V		
≥500V to <1kV	1.5 times			1.5 times	1.5 times		
1kV	1.5 times			1.2 times	1.2 times		
>1kV to ≤1.2kV	1.25 times			1.2 times	1.2 times		
>1.2kV	1.2 times			1.2 times	1.2 times		
Climatic category (IEC)							
Chip	55/125/56			55/85/56	55/125/56		
Ageing characteristic (Typical)	Zero			<2% per time decade	<2% per time decade		

Soldering Information

Knowles MLCCs are compatible with all recognised soldering/mounting methods for chip capacitors. A detailed application note (AN0028) is available at <https://www.knowlesc capacitors.com/Support/Resources>

Reflow Soldering

Knowles recommend reflow soldering as the preferred method for mounting MLCCs. Knowles MLCCs can be reflow soldered using a reflow profile generally defined in IPC/FEDEC J-STD-020. Sn plated termination chip capacitors are compatible with both conventional and lead free soldering with peak temperatures of 260° to 270°C acceptable.

The heating ramp rate should be such that components see a temperature rise of 1.5° to 4°C per second to maintain temperature uniformity through the MLCC.

The time for which the solder is molten should be maintained at a minimum, so as to prevent solder leaching. Extended times above 230°C can cause problems with oxidation of Sn plating. Use of an inert atmosphere can help if this problem is encountered. Palladium/Silver (Pd/Ag) terminations can be particularly susceptible to leaching with free lead, tin rich solders and trials are recommended for this combination.

Cooling to ambient temperature should be allowed to occur naturally, particularly if larger chip sizes are being soldered. Natural cooling allows a gradual relaxation of thermal mismatch stresses in the solder joints. Forced cooling should be avoided as this can induce thermal breakage.

Wave Soldering

Wave soldering is generally acceptable, but the thermal stresses caused by the wave have been shown to lead to potential problems with larger or thicker chips. Particular care should be taken when soldering SM chips larger than size 1210 and with a thickness greater than 1.0mm for this reason.

Maximum permissible wave temperature is 270°C for SM chips.

The total immersion time in solder should be kept to a minimum. It is strongly recommended that Sn/Ni plated terminations are specified for wave soldering applications.

Solder Leaching

Leaching is the term for the dissolution of silver into the solder causing a failure of the termination system which causes increased ESR, tan δ and open circuit faults, including ultimately the possibility of the chip becoming detached.

Leaching occurs more readily with higher temperature solders and solders with a high tin content. Pb free solders can be very prone to leaching certain termination systems. To prevent leaching, exercise care when choosing solder and minimize both maximum temperature and dwell time with the molten solder.

Plated terminations with nickel or copper anti-leaching barrier layers are available in a range of top coat finishes to prevent leaching occurring. These finishes also include Knowles FlexiCap™ for improved stress resistance post soldering.

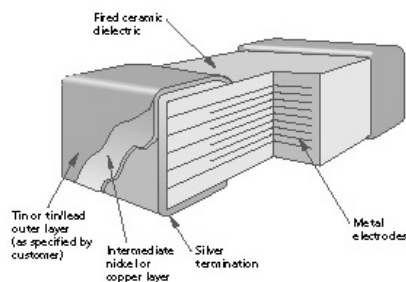

Multilayer ceramic chip with nickel or copper barrier termination

Rework of Chip Capacitors

Knowles recommend hot air/gas as the preferred method of applying heat for rework. Apply even heat surrounding the component to minimise internal thermal gradients. Soldering irons or other techniques that apply direct heat to the chip or surrounding area, should not be used as these can result in micro cracks being generated.

Minimise the rework heat duration and allow components to cool naturally after soldering.

Use of Silver Loaded Epoxy Adhesives

Chip capacitors can be mounted to circuit boards using silver loaded adhesive provided the termination material of the capacitor is selected to be compatible with the adhesive. This is normally PdAg. Standard tin finishes are often not recommended for use with silver loaded epoxies as there can be electrical and mechanical issues with the joint integrity due to material mismatch.

Handling & Storage

Components should never be handled with fingers; perspiration and skin oils can inhibit solderability and will aggravate cleaning.

Chip capacitors should never be handled with metallic instruments. Metal tweezers should never be used as these can chip the product and leave abraded metal tracks on the product surface. Plastic or plastic coated metal types are readily available and recommended – these should be used with an absolute minimum of applied pressure.

Incorrect storage can lead to problems for the user. Rapid tarnishing of the terminations, with an associated degradation of solderability, will occur if the product comes into contact with industrial gases such as sulphur dioxide and chlorine. Storage in free air, particularly moist or polluted air, can result in termination oxidation.

Packaging should not be opened until the MLCs are required for use. If opened, the pack should be re-sealed as soon as practicable. Alternatively, the contents could be kept in a sealed container with an environmental control agent.

Long term storage conditions, ideally, should be temperature controlled between -5° and +40°C and humidity controlled between 40 and 60% R.H.

Taped product should be stored out of direct sunlight, which might promote deterioration in tape or adhesive performance.

Product, stored under the conditions recommended above, in its “as received” packaging, has a minimum shelf life of 2 years.

SM Pad Design

Knowles’ conventional 2-terminal chip capacitors can generally be mounted using pad designs in accordance with IPC-7351, Generic Requirements for Surface Mount Design and Land Pattern Standards, but there are some other factors that have been shown to reduce mechanical stress, such as reducing the pad width to less than the chip width. In addition, the position of the chip on the board should also be considered.

3-terminal components are not specifically covered by IPC-7351, but recommended pad dimensions are included in the Knowles catalogue/website for these components.

FlexiCap™ Termination

FlexiCap™ has been developed as a result of listening to customer experiences of stress damage to MLCCs from many manufacturers, often caused by variations in production processes.

Our answer is a proprietary flexible epoxy polymer termination material, that is applied to the device under the usual nickel barrier finish. FlexiCap™ will accommodate a greater degree of board bending than conventional capacitors.

Ranges are available with FlexiCap™ termination material, offering increased reliability and superior mechanical performance (board flex and temperature cycling) when compared with standard termination materials. Refer to Knowles application note reference AN0001. FlexiCap™ capacitors enable the board to be bent almost twice as much before mechanical cracking occurs. Refer to application note AN0002.

FlexiCap™ is also suitable for space applications having passed thermal vacuum outgassing tests. Refer to Knowles application note reference AN0026.

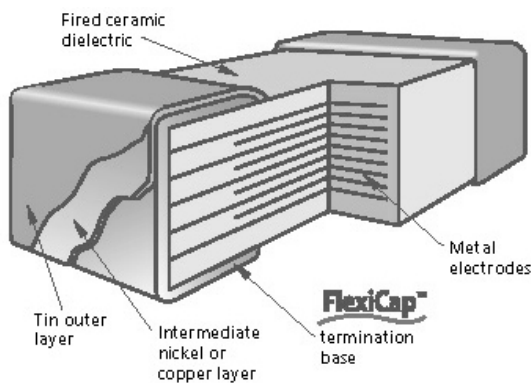

FlexiCap™ MLCC cross section

Knowles has delivered millions of FlexiCap™ components and during that time has collected substantial test and reliability data, working in partnership with customers world wide, to eliminate mechanical cracking.

An additional benefit of FlexiCap™ is that MLCCs can withstand temperature cycling from -55° to 125°C in excess of 1,000 times without cracking.

FlexiCap™ termination has no adverse effect on any electrical parameters, nor affects the operation of the MLCC in any way.

Application Notes

FlexiCap™ may be handled, stored and transported in the same manner as standard terminated capacitors. The requirements for mounting and soldering FlexiCap™ are the same as for standard SMD capacitors.

For customers currently using standard terminated capacitors there should be no requirement to change the assembly process when converting to FlexiCap™.

Based upon the board bend tests in accordance with IEC 60384-1 the amount of board bending required to mechanically crack a FlexiCap™ terminated capacitor is significantly increased compared with standard terminated capacitors.

Product: X7R	Typical bend performance under AEC-Q200 test conditions
Standard Termination	2mm to 3mm
FlexiCap™	Typically 8mm to 10mm

REACH (Registration, Evaluation, Authorisation and restriction of Chemicals) Statement

The main purpose of REACH is to improve the protection of human health and the environment from the risks arising from the use of chemicals.

Knowles maintain both ISO 14001, Environmental Management System and OHSAS 18001 Health & Safety Management System approvals that require and ensure compliance with corresponding legislation such as REACH.

For further information, please contact your local sales office using one of the email addresses at the bottom of the page.

RoHS Compliance

Knowles routinely monitors world wide material restrictions (e.g., EU/China and Korea RoHS mandates) and is actively involved in shaping future legislation.

All standard COG/NP0, X7R, X5R and High Q Knowles MLCC products are compliant with the EU RoHS directive (see below for special exemptions) and those with plated terminations are suitable for soldering common lead free solder alloys (refer to 'Soldering Information' for more details on soldering limitations). Compliance with EU RoHS directive automatically signifies compliance with some other legislation (e.g., Korea RoHS). Please refer to the Sales Office for details of compliance with other materials legislation.

Breakdown of material content, SGS analysis reports and tin whisker test results are available on request.

Most Knowles MLCC components are available with non-RoHS compliant tin/lead (SnPb) Solderable termination finish for exempt applications and where pure tin is not acceptable. Other tin free termination finishes may also be available – please refer to the Sales Office for further details.

For the latest data, environmental certificates can be downloaded from www.knowlesc capacitors.com

Export Controls and Dual-use Regulations

Certain Knowles catalogue components are defined as 'dual-use' items under international export controls – those that can be used for civil and military purposes which meet certain specified technical standards.

The defining criteria for a dual-use component with respect to Knowles products is one with a voltage rating of >750V and a capacitance value >250nF and a series inductance <10nH.

Components defined as 'dual-use' under the above criteria automatically require a licence for export outside the EU, and may require a licence for export with the EU.

The application for a licence is routine, but customers for these products will be asked to supply further information.

Please refer to the sales office if you require any further information on export restrictions.

Other special components may additionally need to comply with export regulations.

Ageing of Ceramic Capacitors

Capacitor ageing is a term used to describe the negative, logarithmic capacitance change which takes place in ceramic capacitors with time. The crystalline structure for barium titanate based ceramics changes on passing through its Curie temperature (known as the Curie Point) at about 125°C. The domain structure relaxes with time and in doing so, the dielectric constant reduces logarithmically; this is known as the ageing mechanism of the dielectric constant. The more stable dielectrics have the lowest ageing rates.

The ageing process is reversible and repeatable. Whenever the capacitor is heated to a temperature above the Curie Point the ageing process starts again from zero.

The ageing constant, or ageing rate, is defined as the percentage loss of capacitance due to the ageing process of the dielectric which occurs during a decade of time (a tenfold increase in age) and is expressed as percent per logarithmic decade of hours. As the law of decrease of capacitance is logarithmic, this means that for a capacitor with an ageing rate of 1% per decade of time, the capacitance will decrease at a rate of:

- 1% between 1 and 10 hours
- An additional 1% between the following 10 and 100 hours
- An additional 1% between the following 100 and 1000 hours
- An additional 1% between the following 1000 and 10000 hours
- The ageing rate continues in this manner throughout the capacitor's life.

Typical values of the ageing constant for our MLCCs are:

Dielectric Class	Typical Values
Ultra Stable COG/NPO	Negligible capacitance loss through ageing
Stable X5R and X7R	<2% per decade of time

Capacitance Measurements

Because of ageing it is necessary to specify an age for reference measurements at which the capacitance shall be within the prescribed tolerance. This is fixed at 1000 hours, since for all practical purposes there is not much further loss of capacitance after this time.

All capacitors shipped are within their specified tolerance at the standard reference age of 1000 hours after having cooled through their Curie temperature.

The ageing curve for any ceramic dielectric is a straight line when plotted on semi-log paper.

Capacitance vs Time

(Ageing X7R @ 1% per decade)

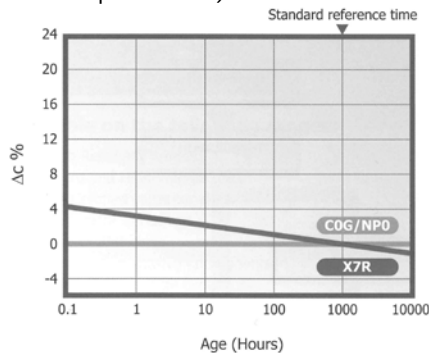

Tight Tolerance

One of the advantages of Knowles's unique 'wet process' of manufacture is the ability to offer capacitors with exceptionally tight capacitance tolerances.

The accuracy of the printing screens used in the fully automated, computer controlled manufacturing process allows for tolerance as close as $\pm 1\%$ on COG/NPO parts greater than or equal to 10pF. For capacitance value less than 4.7pF tolerances can be as tight as $\pm 0.05pF$.

Periodic Tests Conducted and Reliability Data

For standard surface mount capacitors, components are randomly selected on a sample basis and the following routine tests conducted:

- Load Test. 1,000 hours @ 125°C (85°C for X5R, 150°C for X8R). Applied voltage depends on components tested
- Humidity Test. 168 hours @ 85°C/85%RH
- Board Deflection (bend test)

Test results are available on request.

Conversion Factors

From	To	Operation
FITs	MTBF (hours)	$10^9 \div \text{FITs}$
FITs	MTBF (years)	$10^9 \div (\text{FITs} \times 8760)$

FIT = Failures In Time. 1 FIT = 1 failure in 10^9 hours

MTBF = Mean Time Between Failure

Example of FIT Data Available

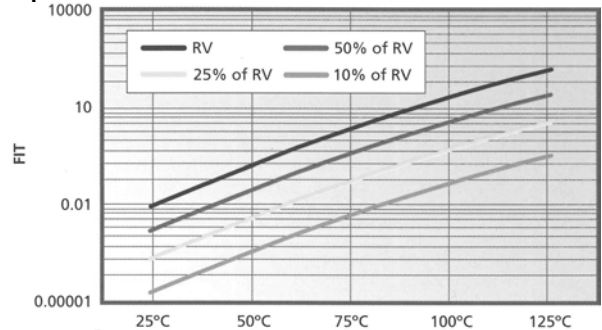

Component type: 0805 (COG/NPO and X7R)

Testing Location: Knowles reliability test department

Results based on: 16,622,000 component test hours

Packaging Information

Tape and reel packing of surface mounting chip capacitors for automatic placement are in accordance with IEC60286-3.

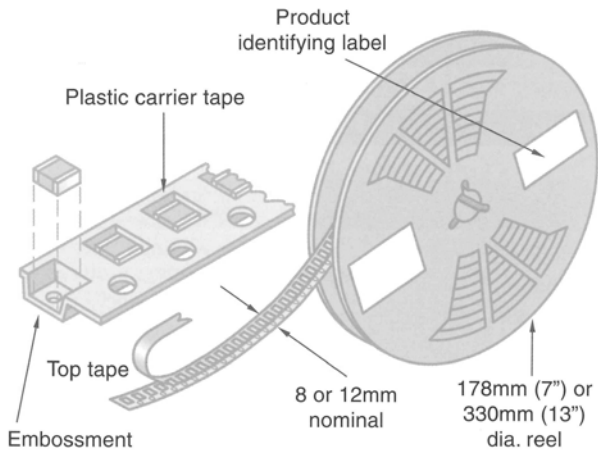

Peel Force

The peel force of the top sealing tape is between 0.2 and 1.0 newton at 180°. The breaking force of the carrier and sealing tape in the direction of unreeling is greater than 10 newtons.

Reel Dimensions

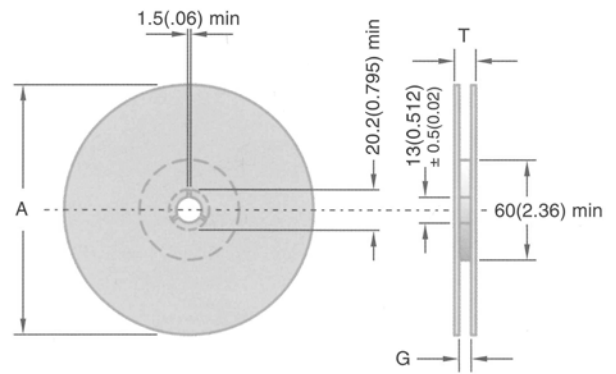

Symbol	Description	178mm Reel	330mm Reel
A	Reel diameter	178 (7)	330 (13)
G	Reel inside width	8.4 (0.33)	12.4 (0.49)
T	Reel outside width	14.4 (0.56) max	18.4 (0.72) max

Tape Dimensions

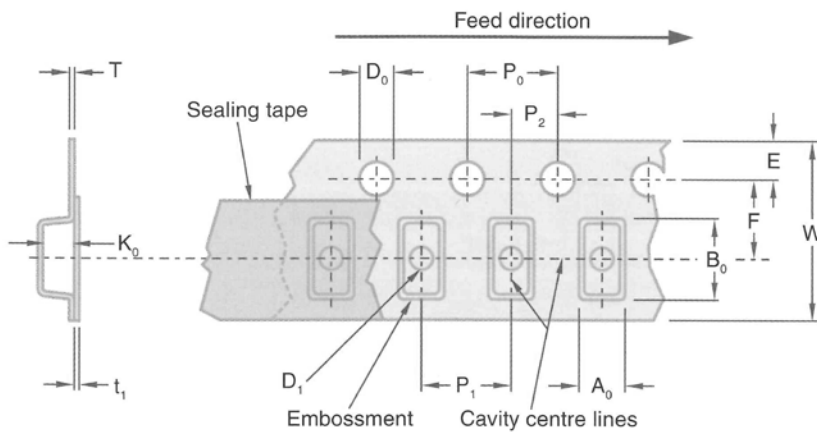

Symbol	Description	Dimensions mm (inches)	
		8mm Tape	12mm Tape
A ₀	Width of cavity	Dependent on chip size to minimize rotation	
B ₀	Length of cavity		
K ₀	Depth of cavity		
W	Width of tape	8.0 (0.315)	12.0 (0.472)
F	Distance between drive hole centres and cavity centres	3.5 (0.138)	5.5 (0.213)
E	Distance between drive hole centres and tape edge	1.75 (0.069)	
P ₁	Distance between cavity centres	4.0 (0.156)	8.0 (0.315)
P ₂	Axial distance between drive hole centres and cavity centres	2.0 (0.079)	
P ₀	Axial distance between drive hole centres	4.0 (0.156)	
D ₀	Drive hole diameter	1.5 (0.059)	
D ₁	Diameter of cavity piercing	1.0 (0.039)	1.5 (0.059)
XT	Carrier tape thickness	0.3 (0.012) ± 0.1 (0.04)	0.4 (0.016) ± 0.1 (0.04)
Xt ₁	Top tape thickness	0.1 (0.004) max	

Packing Information

Missing Components

The number of missing components in the tape may not exceed 0.25% of the total quantity with not more than three consecutive components missing. This must be followed by at least six properly placed components.

Identification

Each reel is labelled with the following information: manufacturer, chip size, capacitance, tolerance, rated voltage, dielectric type, batch number, date code and quantity of components.

Component Orientation

Tape and reeling is in accordance with IEC 60286 part 3, which defines the packaging specifications for leadless components on continuous tapes.

- Notes:
- 1) IEC60286-3 states A0 < B0
 - 2) Regarding the orientation of 1825 and 2225 components, the termination bands are right to left, NOT front to back. Please see diagram.

Leader Trailer

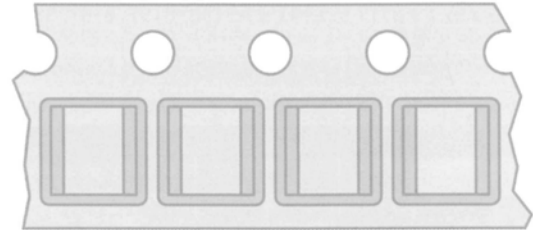
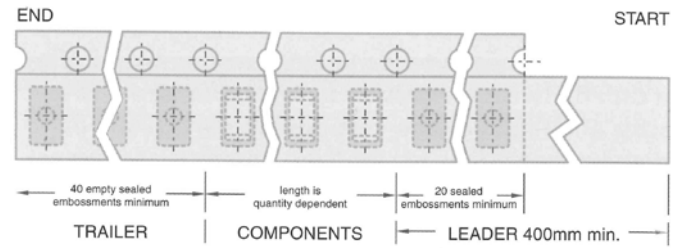

Orientation of 1825 & 2225 components

Outer Packaging

Outer carton dimensions mm (inches) max

Reel Size	No. of Reels	L	W	T
178 (7)	1	185 (7.28)	185 (7.28)	25 (0.98)
178 (7)	4	190 (7.48)	195 (7.76)	75 (2.95)
330 (13)	1	335 (13.19)	335 (13.19)	25 (0.98)

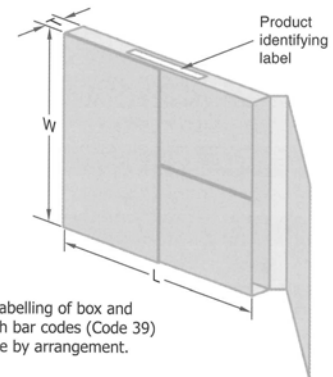

Note: Labelling of box and reel with bar codes (Code 39) available by arrangement.

Reel Quantities

Chip Size		0402	0505	0603	0805	1111	1206	1210	1410	1808	1812	1825	2211	2215	2220	2225	4040
Reel Quantities	178mm (7")	10000	2500	4000	3000	1000	2500	2000	2000	1500	500	500	750	500	500	500	-
	330mm (13")	15000	10000	16000	12000	5000	10000	8000	8000	6000	2000	2000	4000	2000	2000	2000	500

Notes:

- 1) The above quantities per reel are for the maximum manufactured chip thickness. Thinner chips can be taped in larger quantities per reel.
- 2) Where two different quantities are shown for the same case size, please contact the sales office to determine the exact quantity for any specific part number.

Bulk Packing – Tubs

Chips are supplied in rigid re-sealable plastic tubs together with impact cushioning wadding. Tubs are labelled with the details: chip size, capacitance, tolerance, rated voltage, dielectric type, batch number, date code and quantity of components.

Dimensions mm (inches)

H	60mm (2.36")
D	50mm (1.97")

