

Overview

KEMET Power Solutions (KPS) Automotive Series stacked capacitors utilize a proprietary lead-frame technology to vertically stack one or two multilayer ceramic chip capacitors into a single compact surface mount package. The attached lead-frame mechanically isolates the capacitor/s from the printed circuit board, therefore offering advanced mechanical and thermal stress performance. Isolation also addresses concerns for audible, microphonic noise that may occur when a bias voltage is applied. A two chip stack offers up to double the capacitance in the same or smaller design footprint when compared to traditional surface mount MLCC devices. Providing up to 10 mm of board flex capability, KPS Series capacitors are environmentally friendly and in compliance with RoHS legislation. Available in X7R dielectric, these devices are

capable of Pb-Free reflow profiles and provide lower ESR, ESL and higher ripple current capability when compared to other dielectric solutions.

Combined with the stability of an X7R dielectric, KEMET's KPS Series devices exhibit a predictable change in capacitance with respect to time and voltage and boast a minimal change in capacitance with reference to ambient temperature. Capacitance change is limited to $\pm 15\%$ from -55°C to $+125^{\circ}\text{C}$.

KPS Series automotive grade capacitors meet the demanding Automotive Electronics Council's AEC-Q200 qualification requirements.

Benefits

- AEC-Q200 automotive qualified
- -55°C to $+125^{\circ}\text{C}$ operating temperature range
- Reliable and robust termination system
- EIA 1210, 1812, and 2220 Case sizes
- DC voltage ratings of 10 V, 16 V, 25 V, 50 V, 100 V, and 250 V

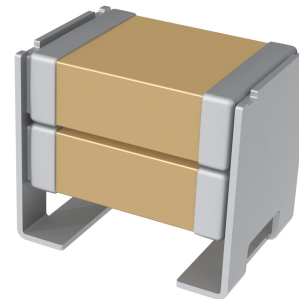

Ordering Information

C	2220	C	106	M	5	R	2	C	AUTO
Ceramic	Case Size (L" x W")	Specification/ Series	Capacitance Code (pF)	Capacitance Tolerance ¹	Rated Voltage (VDC)	Dielectric	Failure Rate/Design	Leadframe Finish ²	Packaging/Grade (C-Spec)
	1210 1812 2220	C = Standard	Two significant digits and number of zeros	K = $\pm 10\%$ M = $\pm 20\%$	8 = 10 4 = 16 3 = 25 5 = 50 1 = 100 A = 250	R = X7R	1 = KPS Single Chip Stack 2 = KPS Double Chip Stack	C = 100% Matte Sn	See "Packaging C-Spec Ordering Options Table"

¹ Double chip stacks ("2" in the 13th character position of the ordering code) are only available in M ($\pm 20\%$) capacitance tolerance. Single chip stacks ("1" in the 13th character position of the ordering code) are available in K ($\pm 10\%$) or M ($\pm 20\%$) tolerances.

² Additional leadframe finish options may be available. Contact KEMET for details.

Packaging C-Spec Ordering Options Table

Packaging Type ¹	Packaging/Grade Ordering Code (C-Spec) ²
7" Reel (Embossed Plastic Tape)/Unmarked	AUTO
13" Reel (Embossed Plastic Tape)/Unmarked	AUTO 7289

¹ The terms "Marked" and "Unmarked" pertain to laser marking option of capacitors. All packaging options labeled as "Unmarked" will contain capacitors that have not been laser marked. The option to laser mark is not available on these devices. For more information see "Capacitor Marking".

² For additional information regarding "AUTO" C-Spec options, see "Automotive C-Spec Information".

Benefits cont.

- Capacitance offerings ranging from 0.1 μ F up to 47 μ F
- Available capacitance tolerances of $\pm 10\%$ and $\pm 20\%$
- Higher capacitance in the same footprint
- Potential board space savings
- Advanced protection against thermal and mechanical stress
- Provides up to 10 mm of board flex capability
- Reduces audible, microphonic noise
- Extremely low ESR and ESL
- Lead (Pb)-free, RoHS and REACH compliant
- Capable of Pb-free reflow profiles
- Non-polar device, minimizing installation concerns
- Tantalum and electrolytic alternative

Applications

Typical applications include smoothing circuits, DC/DC converters, power supplies (input/output filters), noise reduction (piezoelectric/mechanical), circuits with a direct battery or power source connection, critical and safety relevant circuits without (integrated) current limitation and any application that is subject to high levels of board flexure or temperature cycling.

Qualification/Certification

Automotive Grade products meet or exceed the requirements outlined by the Automotive Electronics Council. Details regarding test methods and conditions are referenced in document AEC-Q200, Stress Test Qualification for Passive Components. For additional information regarding the Automotive Electronics Council and AEC-Q200, please visit their website at www.aecouncil.com.

Environmental Compliance

Lead (Pb)-free, RoHS, and REACH compliant without exemptions.

Automotive C-Spec Information

KEMET automotive grade products meet or exceed the requirements outlined by the Automotive Electronics Council. Details regarding test methods and conditions are referenced in document AEC-Q200, Stress Test Qualification for Passive Components. These products are supported by a Product Change Notification (PCN) and Production Part Approval Process warrant (PPAP).

Automotive products offered through our distribution channel have been assigned an inclusive ordering code C-Spec, "AUTO." This C-Spec was developed in order to better serve small and medium-sized companies that prefer an automotive grade component without the requirement to submit a customer Source Controlled Drawing (SCD) or specification for review by a KEMET engineering specialist. This C-Spec is therefore not intended for use by KEMET OEM automotive customers and are not granted the same "privileges" as other automotive C-Specs. Customer PCN approval and PPAP request levels are limited (see details below.)

Product Change Notification (PCN)

The KEMET product change notification system is used to communicate primarily the following types of changes:

- Product/process changes that affect product form, fit, function, and/or reliability
- Changes in manufacturing site
- Product obsolescence

KEMET Automotive C-Spec	Customer Notification Due To:		Days Prior To Implementation
	Process/Product change	Obsolescence*	
KEMET assigned ¹	Yes (with approval and sign off)	Yes	180 days minimum
AUTO	Yes (without approval)	Yes	90 days minimum

¹ KEMET assigned C-Specs require the submittal of a customer SCD or customer specification for review. For additional information contact KEMET.

Production Part Approval Process (PPAP)

The purpose of the Production Part Approval Process is:

- To ensure that supplier can meet the manufacturability and quality requirements for the purchased parts.
- To provide the evidence that all customer engineering design records and specification requirements are properly understood and fulfilled by the manufacturing organization.
- To demonstrate that the established manufacturing process has the potential to produce the part.

KEMET Automotive C-Spec	PPAP (Product Part Approval Process) Level				
	1	2	3	4	5
KEMET assigned ¹	●	●	●	●	●
AUTO			○		

¹ KEMET assigned C-Specs require the submittal of a customer SCD or customer specification for review. For additional information contact KEMET.

- Part number specific PPAP available
- Product family PPAP only

Dimensions – Millimeters (Inches)

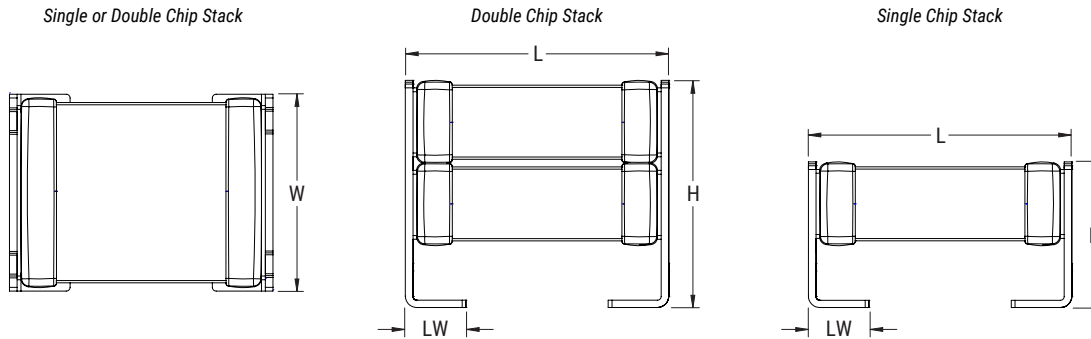

Number of Chips	EIA Size Code	Metric Size Code	L Length	W Width	H Height	LW Lead Width	Mounting Technique
Single	1210	3225	3.50 (0.138) ±0.30 (0.012)	2.60 (0.102) ±0.30 (0.012)	3.35 (0.132) ±0.10 (0.004)	0.80 (0.032) ±0.15 (0.006)	Solder Reflow Only
	1812	4532	5.00 (0.197) ±0.50 (0.020)	3.50 (0.138) ±0.50 (0.020)	2.65 (0.104) ±0.35 (0.014)	1.10 (0.043) ±0.30 (0.012)	
	2220	5650	6.00 (0.236) ±0.50 (0.020)	5.00 (0.197) ±0.50 (0.020)	3.50 (0.138) ±0.30 (0.012)	1.60 (0.063) ±0.30 (0.012)	
Double	1210	3225	3.50 (0.138) ±0.30 (0.012)	2.60 (0.102) ±0.30 (0.012)	6.15 (0.242) ±0.15 (0.006)	0.80 (0.031) ±0.15 (0.006)	
	1812	4532	5.00 (0.197) ±0.50 (0.020)	3.50 (0.138) ±0.50 (0.020)	5.00 (0.197) ±0.50 (0.020)	1.10 (0.043) ±0.30 (0.012)	
	2220	5650	6.00 (0.236) ±0.50 (0.020)	5.00 (0.197) ±0.50 (0.020)	5.00 (0.197) ±0.50 (0.020)	1.60 (0.063) ±0.30 (0.012)	

Electrical Parameters/Characteristics

Item	Parameters/Characteristics
Operating Temperature Range	-55°C to +125°C
Capacitance Change with Reference to +25°C and 0 VDC Applied (TCC)	±15%
Aging Rate (Maximum % Capacitance Loss/Decade Hour)	3.0%
Dielectric Withstanding Voltage (DWV)	250% of rated voltage (5±1 seconds and charge/discharge not exceeding 50 mA)
Dissipation Factor (DF) Maximum Limit at 25°C	5% (6.3 and 10 V), 3.5% (16 and 25 V) and 2.5% (50 to 250 V)
Insulation Resistance (IR) Limit at 25°C	See Insulation Resistance Limit Table (Rated voltage applied for 120±5 seconds at 25°C)

Regarding aging rate: Capacitance measurements (including tolerance) are indexed to a referee time of 1,000 hours.

To obtain IR limit, divide MΩ-μF value by the capacitance and compare to GΩ limit. Select the lower of the two limits.

Capacitance and dissipation factor (DF) measured under the following conditions:

1 kHz ±50 Hz and 1.0 ±0.2 Vrms if capacitance ≤ 10 μF

120 Hz ±10 Hz and 0.5 ±0.1 Vrms if capacitance > 10 μF

Note: When measuring capacitance it is important to ensure the set voltage level is held constant. The HP4284 and Agilent E4980 have a feature known as Automatic Level Control (ALC). The ALC feature should be switched to "ON."

Post Environmental Limits

High Temperature Life, Biased Humidity, Moisture Resistance					
Dielectric	Rated DC Voltage	Capacitance Value	Dissipation Factor (Maximum %)	Capacitance Shift	Insulation Resistance
X7R	> 25	All	3.0	±20%	10% of Initial Limit
	16/25		5.0		
	< 16		7.5		

Insulation Resistance Limit Table

EIA Case Size	1,000 Megohm Microfarads or 100 GΩ	500 Megohm Microfarads or 10 GΩ
1210	< 0.39 μF	≥ 0.39 μF
1812	< 2.2 μF	≥ 2.2 μF
2220	< 10 μF	≥ 10 μF

Electrical Characteristics

Z and ESR C1210C475M5R1C

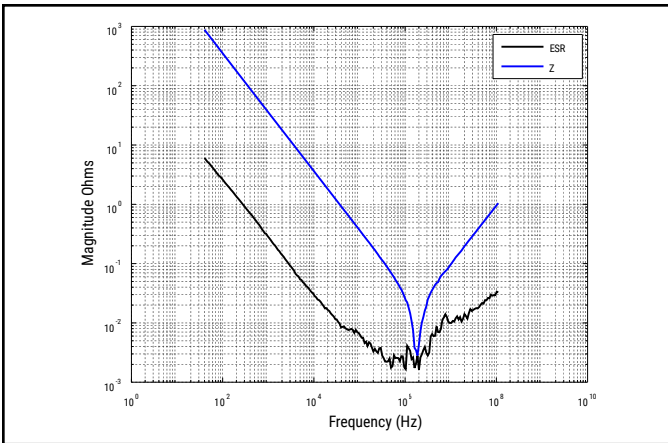

Z and ESR C2220C476M3R2C

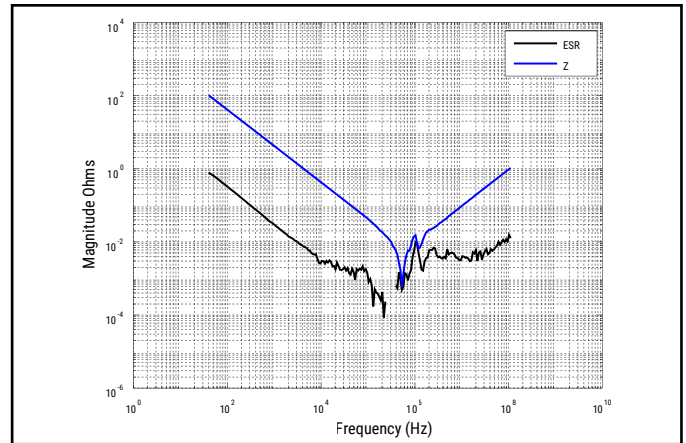

ESR – 1812, .10 μ F, 50 V X7R

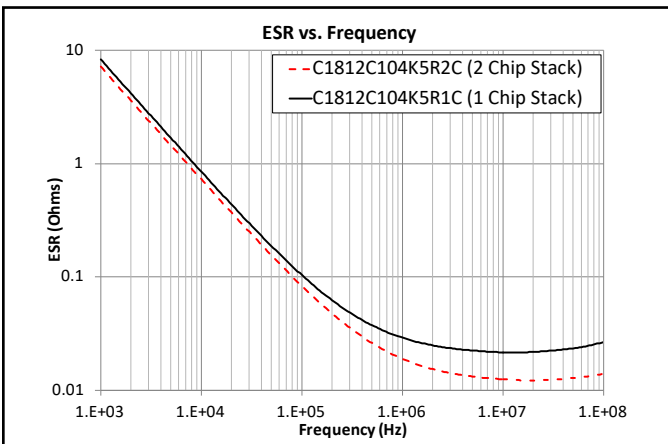

Impedance – 1812, .10 μ F, 50 V X7R

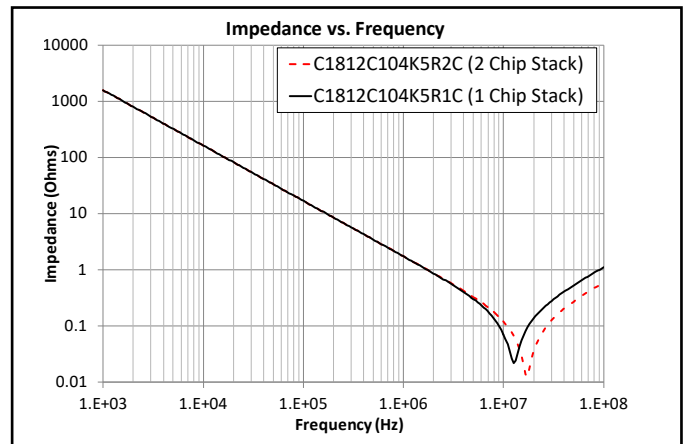

ESR – 1210, .22 μ F, 50 V X7R

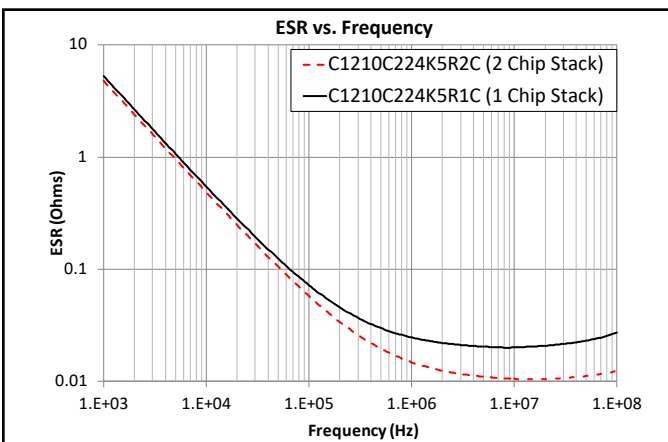

Impedance – 1210, .22 μ F, 50 V X7R

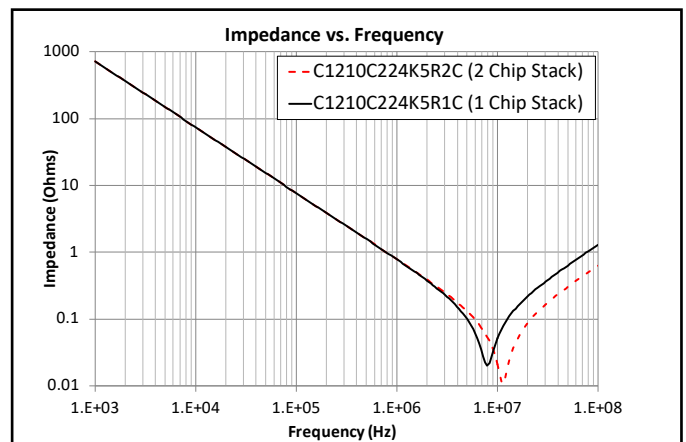

Electrical Characteristics cont.

Microphonics – 1210, 4.7 μ F, 50 V, X7R

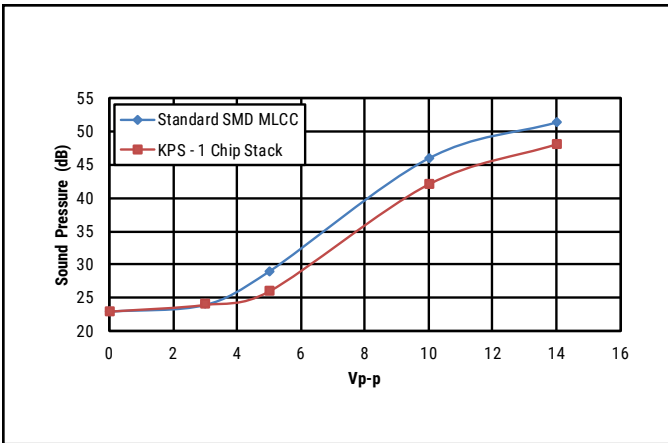

Microphonics – 2220, 22 μ F, 50 V, X7R

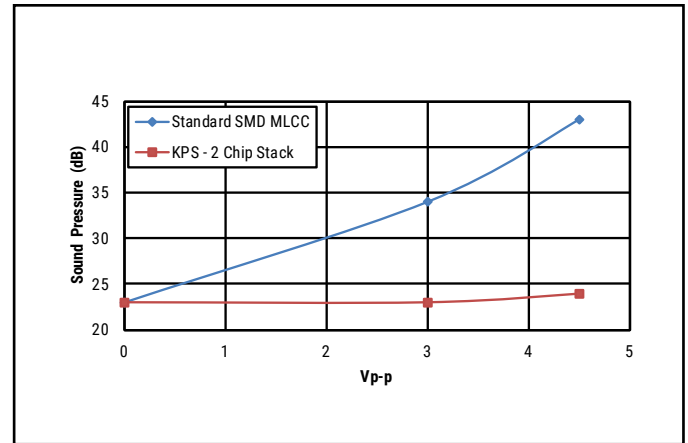

Microphonics – 2220, 47 μ F, 25 V, X7R

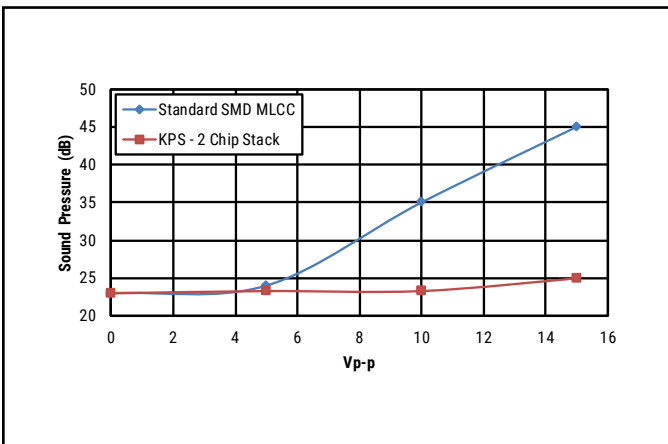

Microphonics – 1210, 22 μ F, 25 V, X7R

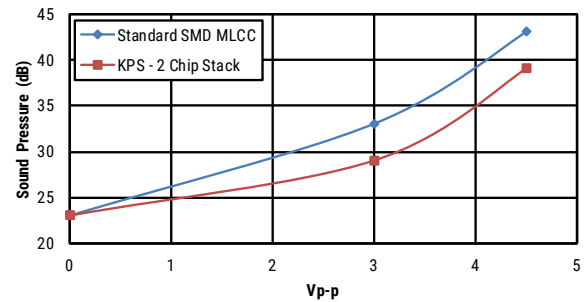

Competitive Comparison

Ripple Current (A_{rms}) 2220, 22 μ F, 50 V

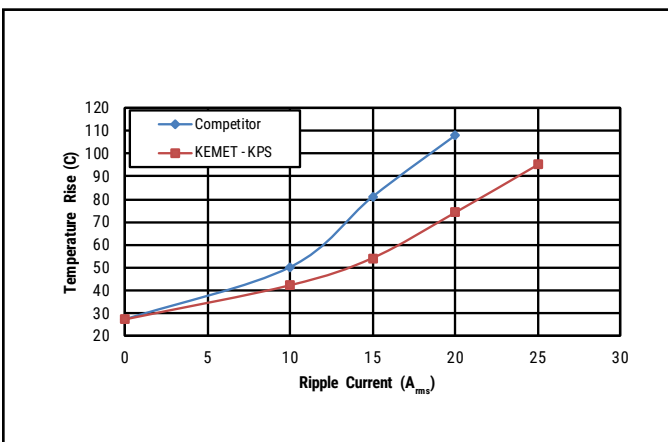

Electrical Characteristics cont.

Board Flex vs. Termination Type

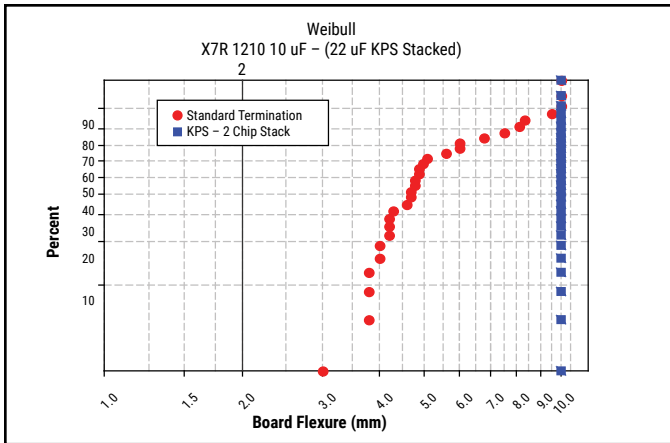

Board Flex vs. Termination Type

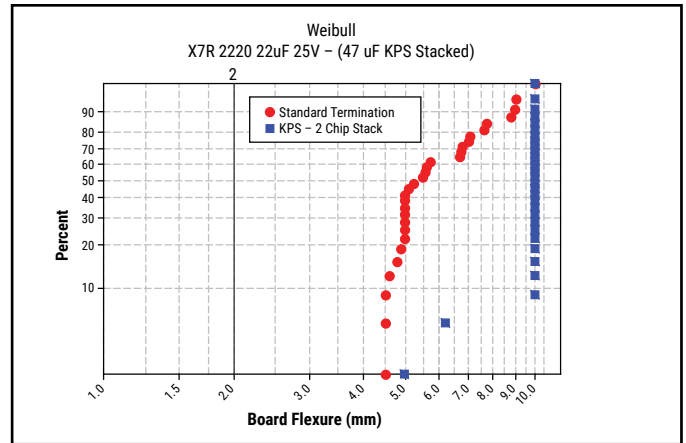

Board Flexure to 10 mm

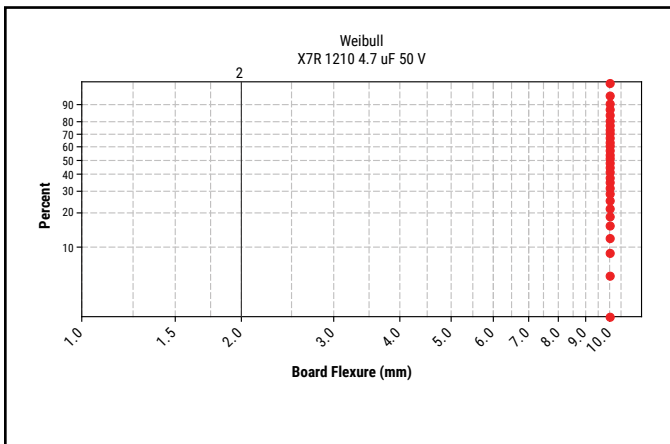

Board Flexure to 10 mm

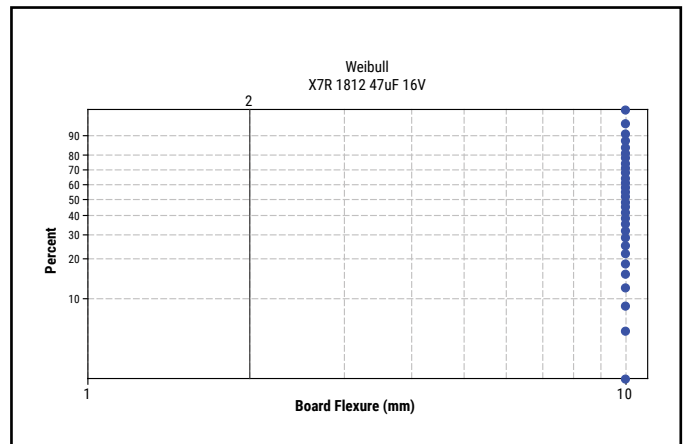

Table 1 – Capacitance Range/Selection Waterfall (1210 – 2220 Case Sizes)

Capacitance	Cap Code	Case Size/Series		C1210C						C1812C					C2220C				
		Voltage Code		8	4	3	5	1	A	4	3	5	1	A	4	3	5	1	A
		Rated Voltage (VDC)		10	16	25	50	100	250	16	25	50	100	250	16	25	50	100	250
		Capacitance Tolerance		Product Availability and Chip Thickness Codes See Table 2 for Chip Thickness Dimensions															
Single Chip Stack																			
0.10 µF	104	K	M	FV	FV	FV	FV	FV	FV	GP	GP	GP	UD	UD	JP	JP	JP	JP	JP
0.22 µF	224	K	M	FV	FV	FV	FV	FV	FV	GP	GP	GP	UD	UD	JP	JP	JP	JP	JP
0.47 µF	474	K	M	FV	FV	FV	FV	FV	FV	GP	GP	GP	UD	UD	JP	JP	JP	JP	JP
1.0 µF	105	K	M	FV	FV	FV	FV	FV	FV	GP	GP	GP	UD		JP	JP	JP	JP	JP
2.2 µF	225	K	M	FV	FV	FV	FV			GP	GP	GP			JP	JP	JP	UD	
3.3 µF	335	K	M	FV	FV	FV	FV			GP	GP	GP			JP	JP	JP	UD	
4.7 µF	475	K	M	FV	FV	FV	FV			GP	GP	GP			JP	JP	JP		
10 µF	106	K	M	FV	FV	FV				GP	GP				JP	JP	JP		
15 µF	156	K	M												JP	JP			
22 µF	226	K	M												JP	JP			
Double Chip Stack																			
0.10 µF	104		M	FW	FW	FW	FW	FW	FW	GR	GR	GR	UD	UD	JR	JR	JR	JR	JR
0.22 µF	224		M	FW	FW	FW	FW	FW	FW	GR	GR	GR	UD	UD	JR	JR	JR	JR	JR
0.47 µF	474		M	FW	FW	FW	FW	FW	FW	GR	GR	GR	UD	UD	JR	JR	JR	JR	JR
1.0 µF	105		M	FW	FW	FW	FW	FW		GR	GR	GR	UD	UD	JR	JR	JR		
2.2 µF	225		M	FW	FW	FW	FW	FW		GR	GR	GR	UD		JR	JR	JR		
3.3 µF	335		M	FW	FW	FW	FW			GR	GR	GR	UD		JR	JR	JR	UD	
4.7 µF	475		M	FW	FW	FW	FW			GR	GR	GR			JR	JR	JR		
10 µF	106		M	FW	FW	FW	FW			GR	GR	GR			JR	JR	JR		
22 µF	226		M	FW	FW	FW				GR	GR				JR	JR	JR		
33 µF	336		M												JR	JR			
47 µF	476		M												JR	JR			
Capacitance	Cap Code	Rated Voltage (VDC)		10	16	25	50	100	250	16	25	50	100	250	16	25	50	100	250
		Voltage Code		8	4	3	5	1	A	4	3	5	1	A	4	3	5	1	A
		Case Size/Series		C1210C						C1812C					C2220C				

UD = Under development

These products are protected under US Patent 8,331,078 other patents pending, and any foreign counterparts.

Table 2 – Chip Thickness/Tape & Reel Packaging Quantities

Thickness Code	Case Size	Thickness ± Range (mm)	Paper Quantity		Plastic Quantity	
			7" Reel	13" Reel	7" Reel	13" Reel
FV	1210	3.35 ± 0.10	0	0	600	2,000
FW	1210	6.15 ± 0.15	0	0	300	1,000
GP	1812	2.65 ± 0.35	0	0	500	2,000
GR	1812	5.00 ± 0.50	0	0	400	1,700
JP	2220	3.50 ± 0.30	0	0	300	1,300
JR	2220	5.00 ± 0.50	0	0	200	800
Thickness Code	Case Size	Thickness ± Range (mm)	7" Reel	13" Reel	7" Reel	13" Reel
			Paper Quantity		Plastic Quantity	

Package quantity based on finished chip thickness specifications.

Table 3 – KPS Land Pattern Design Recommendations (mm)

EIA SIZE CODE	METRIC SIZE CODE	Median (Nominal) Land Protrusion				
		C	Y	X	V1	V2
1210	3225	1.50	1.14	1.75	5.05	3.40
1812	4532	2.20	1.35	2.87	6.70	4.50
2220	5650	2.69	2.08	4.78	7.70	6.00

Image at right based on an EIA 1210 case size.

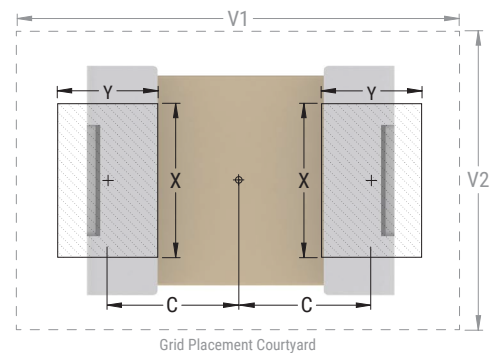

KEMET's KPS Series land pattern design recommendations have been evaluated through extensive internal testing and validation. KPS lead frames are used to mechanically isolate the MLCC from the PCB and provide stress relief for increased mechanical robustness. The land pattern dimensions for each EIA size code are designed to be encompassed within the end terminations thus regulating solder wicking and maintaining lead frame flexibility. This design is optimized to enable durable solder joint fillets which improve the mechanical integrity and reliability upon placement.

Soldering Process

KEMET's KPS Series devices are compatible with IR reflow techniques. Preheating of these components is recommended to avoid extreme thermal stress. KEMET's recommended profile conditions for IR reflow reflect the profile conditions of the IPC/J-STD-020D standard for moisture sensitivity testing.

To prevent degradation of temperature cycling capability, care must be taken to prevent solder from flowing into the inner side of the lead frames (inner side of "J" lead in contact with the circuit board).

After soldering, the capacitors should be air cooled to room temperature before further processing. Forced air cooling is not recommended.

Hand soldering should be performed with care due to the difficulty in process control. If performed, care should be taken to avoid contact of the soldering iron to the capacitor body. The iron should be used to heat the solder pad, applying solder between the pad and the lead, until reflow occurs. Once reflow occurs, the iron should be removed immediately. (Preheating is required when hand soldering to avoid thermal shock.)

Profile Feature	SnPb Assembly	Pb-Free Assembly
Preheat/Soak		
Temperature Minimum (T_{smin})	100°C	150°C
Temperature Maximum (T_{smax})	150°C	200°C
Time (t_s) from T_{smin} to T_{smax}	60 – 120 seconds	60 – 120 seconds
Ramp-up Rate (T_L to T_p)	3°C/seconds maximum	3°C/seconds maximum
Liquidous Temperature (T_L)	183°C	217°C
Time Above Liquidous (t_L)	60 – 150 seconds	60 – 150 seconds
Peak Temperature (T_p)	235°C	250°C
Time within 5°C of Maximum Peak Temperature (t_p)	20 seconds maximum	10 seconds maximum
Ramp-down Rate (T_p to T_L)	6°C/seconds maximum	6°C/seconds maximum
Time 25°C to Peak Temperature	6 minutes maximum	8 minutes maximum

Note: All temperatures refer to the center of the package, measured on the package body surface that is facing up during assembly reflow.

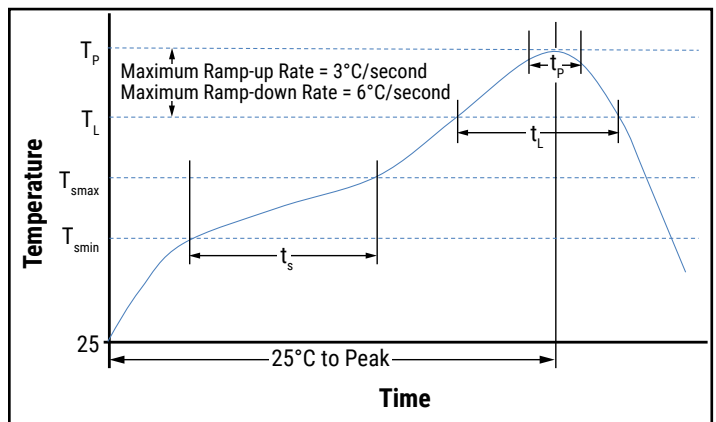

Storage & Handling

Ceramic chip capacitors should be stored in normal working environments. While the chips themselves are quite robust in other environments, solderability will be degraded by exposure to high temperatures, high humidity, corrosive atmospheres, and long term storage. In addition, packaging materials will be degraded by high temperature—reels may soften or warp and tape peel force may increase. KEMET recommends that maximum storage temperature not exceed 40°C and maximum storage humidity not exceed 70% relative humidity. Temperature fluctuations should be minimized to avoid condensation on the parts and atmospheres should be free of chlorine and sulfur bearing compounds. For optimized solderability chip stock should be used promptly, preferably within 1.5 years of receipt.

Construction (Typical)

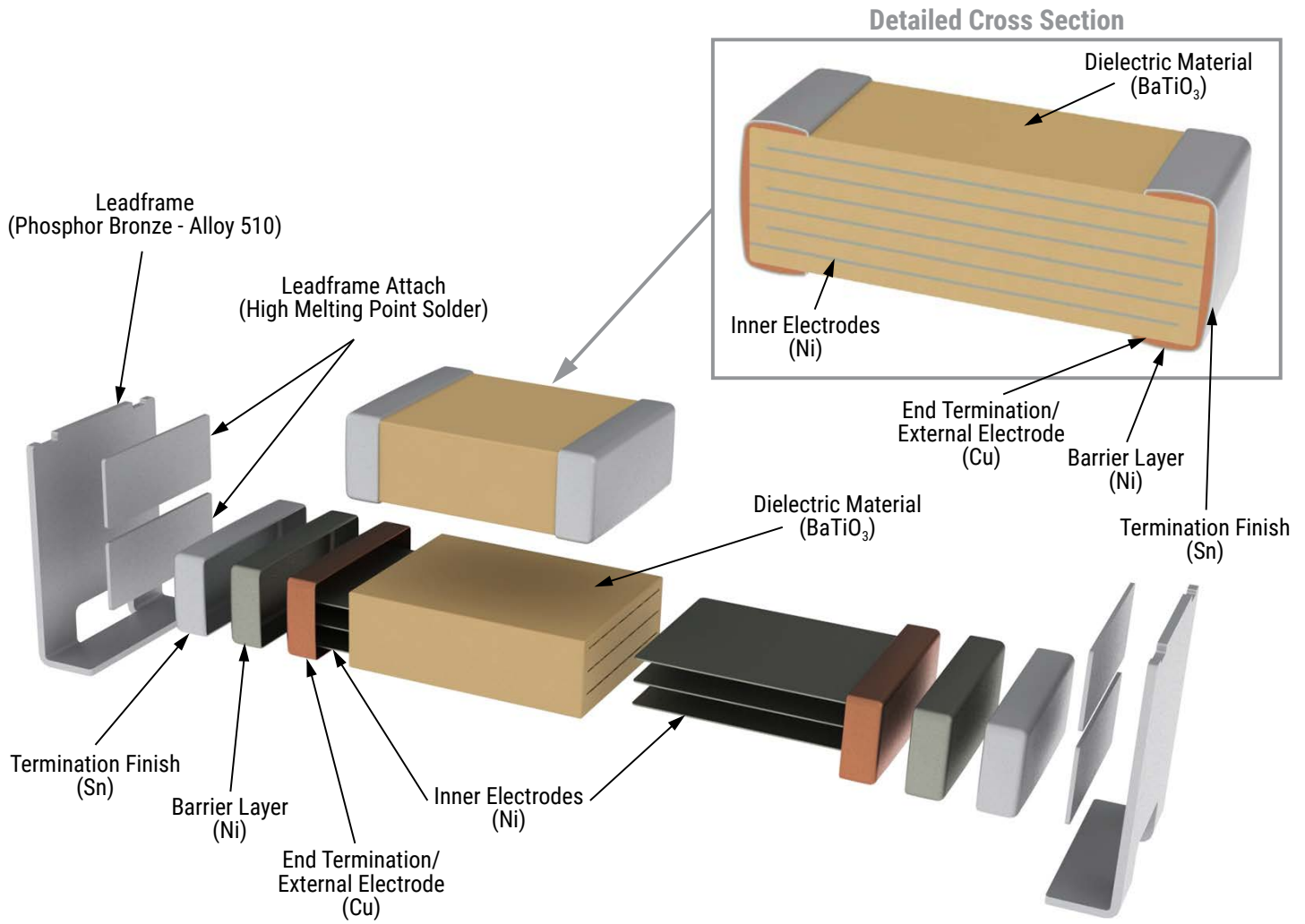

Product Marking

Laser marking option is not available on:

- COG, Ultra Stable X8R and Y5V dielectric devices
- EIA 0402 case size devices
- EIA 0603 case size devices with Flexible Termination option.
- KPS Commercial and Automotive grade stacked devices.

These capacitors are supplied unmarked only.

Tape & Reel Packaging Information

KEMET offers multilayer ceramic chip capacitors packaged in 8, 12 and 16 mm tape on 7" and 13" reels in accordance with EIA Standard 481. This packaging system is compatible with all tape-fed automatic pick and place systems. See Table 2 for details on reeling quantities for commercial chips.

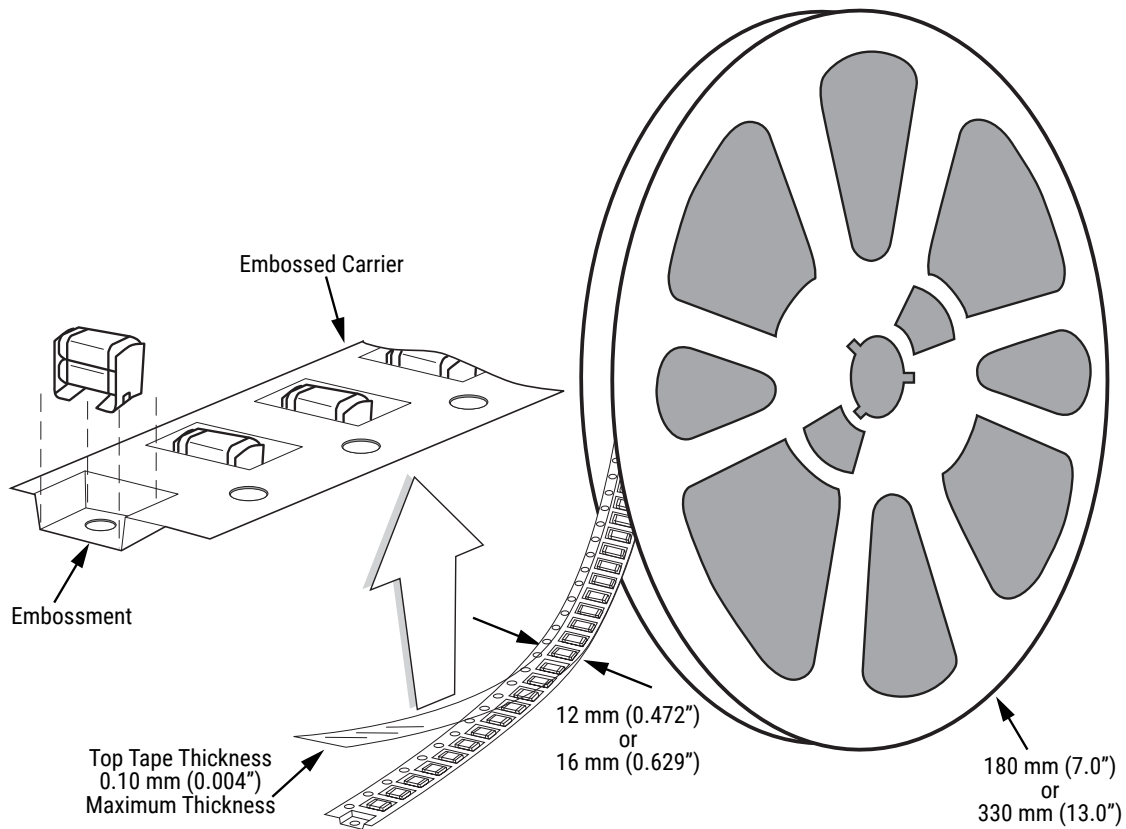

Table 4 – Carrier Tape Configuration – Embossed Plastic (mm)

EIA Case Size	Tape Size (W)*	Pitch (P ₁)*
01005 – 0402	8	2
0603 – 1210	8	4
1805 – 1808	12	4
≥ 1812	12	8
KPS 1210	12	8
KPS 1812 & 2220	16	12
Array 0508 & 0612	8	4

*Refer to Figure 1 for W and P₁ carrier tape reference locations.

*Refer to Table 5 for tolerance specifications.

Figure 1 – Embossed (Plastic) Carrier Tape Dimensions

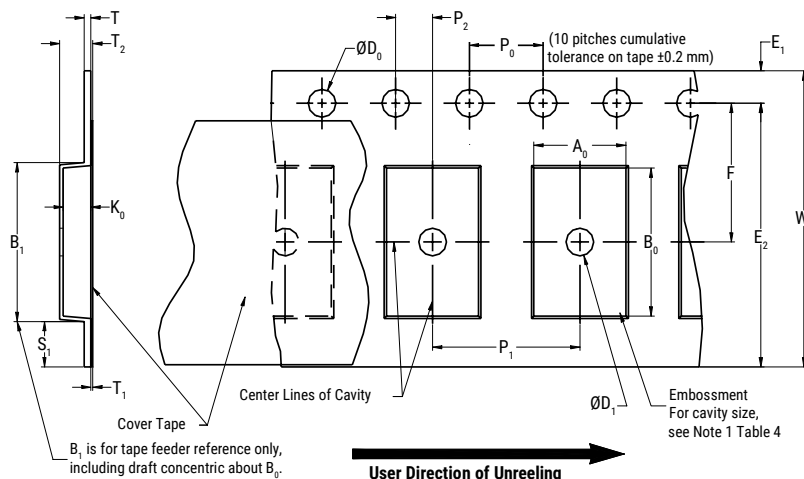

Table 5 – Embossed (Plastic) Carrier Tape Dimensions

Metric will govern

Constant Dimensions – Millimeters (Inches)									
Tape Size	D ₀	D ₁ Minimum Note 1	E ₁	P ₀	P ₂	R Reference Note 2	S ₁ Minimum Note 3	T Maximum	T ₁ Maximum
8 mm	1.5+0.10/0.0-0.0 (0.059+0.004/-0.0)	1.0 (0.039)	1.75±0.10 (0.069±0.004)	4.0±0.10 (0.157±0.004)	2.0±0.05 (0.079±0.002)	25.0 (0.984)	0.600 (0.024)	0.600 (0.024)	0.100 (0.004)
12 mm		1.5 (0.059)				30 (1.181)			
16 mm									
Variable Dimensions – Millimeters (Inches)									
Tape Size	Pitch	B ₁ Maximum Note 4	E ₂ Minimum	F	P ₁	T ₂ Maximum	W Maximum	A ₀ , B ₀ & K ₀	
8 mm	Single (4 mm)	4.35 (0.171)	6.25 (0.246)	3.5±0.05 (0.138±0.002)	4.0±0.10 (0.157±0.004)	2.5 (0.098)	8.3 (0.327)	Note 5	
12 mm	Single (4 mm) & Double (8 mm)	8.2 (0.323)	10.25 (0.404)	5.5±0.05 (0.217±0.002)	8.0±0.10 (0.315±0.004)	4.6 (0.181)	12.3 (0.484)		
16 mm	Triple (12 mm)	12.1 (0.476)	14.25 (0.561)	7.5±0.05 (0.138±0.002)	12.0±0.10 (0.157±0.004)	4.6 (0.181)	16.3 (0.642)		

1. The embossment hole location shall be measured from the sprocket hole controlling the location of the embossment. Dimensions of embossment location and hole location shall be applied independent of each other.
2. The tape with or without components shall pass around R without damage (see Figure 5).
3. If S₁ < 1.0 mm, there may not be enough area for cover tape to be properly applied (see EIA Standard 481 paragraph 4.3 section b).
4. B₁ dimension is a reference dimension for tape feeder clearance only.
5. The cavity defined by A₀, B₀ and K₀ shall surround the component with sufficient clearance that:
 - (a) the component does not protrude above the top surface of the carrier tape.
 - (b) the component can be removed from the cavity in a vertical direction without mechanical restriction, after the top cover tape has been removed.
 - (c) rotation of the component is limited to 20° maximum for 8 and 12 mm tapes and 10° maximum for 16 mm tapes (see Figure 2).
 - (d) lateral movement of the component is restricted to 0.5 mm maximum for 8 and 12 mm wide tape and to 1.0 mm maximum for 16 mm tape (see Figure 3).
 - (e) for KPS Series product, A₀ and B₀ are measured on a plane 0.3 mm above the bottom of the pocket.
 - (f) see Addendum in EIA Standard 481 for standards relating to more precise taping requirements.

Packaging Information Performance Notes

- Cover Tape Break Force:** 1.0 Kg minimum.
- Cover Tape Peel Strength:** The total peel strength of the cover tape from the carrier tape shall be:

Tape Width	Peel Strength
8 mm	0.1 to 1.0 newton (10 to 100 gf)
12 and 16 mm	0.1 to 1.3 newton (10 to 130 gf)

The direction of the pull shall be opposite the direction of the carrier tape travel. The pull angle of the carrier tape shall be 165° to 180° from the plane of the carrier tape. During peeling, the carrier and/or cover tape shall be pulled at a velocity of 300 ±10 mm/minute.

- Labeling:** Bar code labeling (standard or custom) shall be on the side of the reel opposite the sprocket holes. Refer to EIA Standards 556 and 624.

Figure 2 – Maximum Component Rotation



Figure 3 – Maximum Lateral Movement



Figure 4 – Bending Radius



Figure 5 – Reel Dimensions



Note: Drive spokes optional; if used, dimensions B and D shall apply.

Table 6 – Reel Dimensions

Metric will govern

Constant Dimensions – Millimeters (Inches)				
Tape Size	A	B Minimum	C	D Minimum
8 mm	178±0.20 (7.008±0.008) or 330±0.20 (13.000±0.008)	1.5 (0.059)	13.0+0.5/-0.2 (0.521+0.02/-0.008)	20.2 (0.795)
12 mm				
16 mm				
Variable Dimensions – Millimeters (Inches)				
Tape Size	N Minimum	W ₁	W ₂ Maximum	W ₃
8 mm	50 (1.969)	8.4+1.5/-0.0 (0.331+0.059/-0.0)	14.4 (0.567)	Shall accommodate tape width without interference
12 mm		12.4+2.0/-0.0 (0.488+0.078/-0.0)	18.4 (0.724)	
16 mm		16.4+2.0/-0.0 (0.646+0.078/-0.0)	22.4 (0.882)	

Figure 6 – Tape Leader & Trailer Dimensions

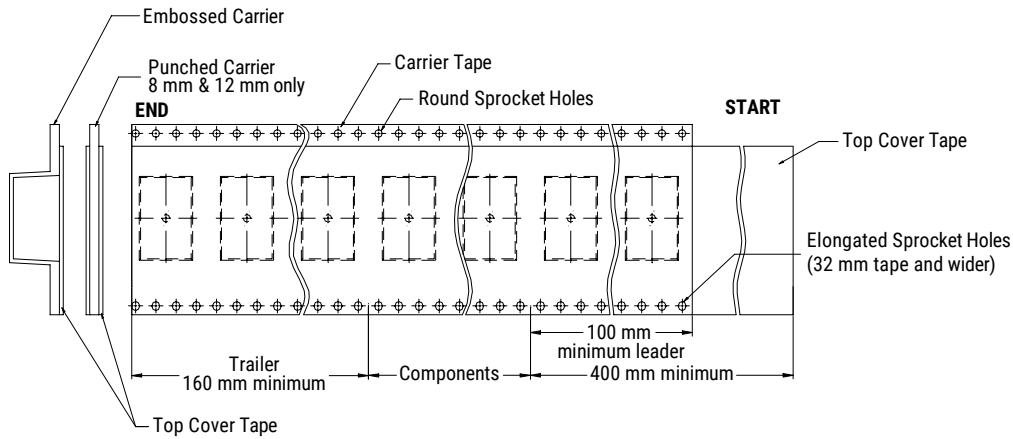
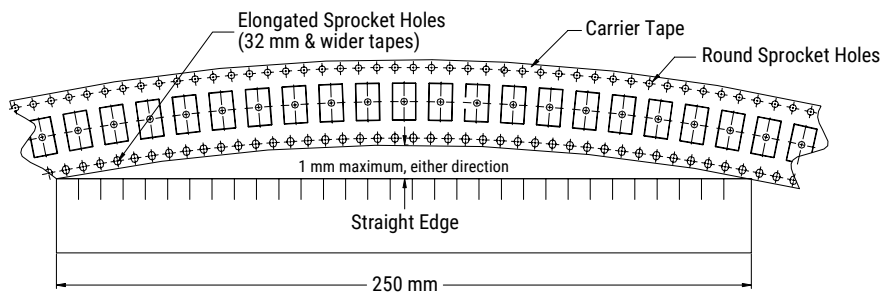

Figure 7 – Maximum Camber



KEMET Electronics Corporation Sales Offices

For a complete list of our global sales offices, please visit www.kemet.com/sales.

Disclaimer

All product specifications, statements, information and data (collectively, the "Information") in this datasheet are subject to change. The customer is responsible for checking and verifying the extent to which the Information contained in this publication is applicable to an order at the time the order is placed. All Information given herein is believed to be accurate and reliable, but it is presented without guarantee, warranty, or responsibility of any kind, expressed or implied.

Statements of suitability for certain applications are based on KEMET Electronics Corporation's ("KEMET") knowledge of typical operating conditions for such applications, but are not intended to constitute – and KEMET specifically disclaims – any warranty concerning suitability for a specific customer application or use. The Information is intended for use only by customers who have the requisite experience and capability to determine the correct products for their application. Any technical advice inferred from this Information or otherwise provided by KEMET with reference to the use of KEMET's products is given gratis, and KEMET assumes no obligation or liability for the advice given or results obtained.

Although KEMET designs and manufactures its products to the most stringent quality and safety standards, given the current state of the art, isolated component failures may still occur. Accordingly, customer applications which require a high degree of reliability or safety should employ suitable designs or other safeguards (such as installation of protective circuitry or redundancies) in order to ensure that the failure of an electrical component does not result in a risk of personal injury or property damage.

Although all product-related warnings, cautions and notes must be observed, the customer should not assume that all safety measures are indicated or that other measures may not be required.

KEMET is a registered trademark of KEMET Electronics Corporation.