

Low Power, Low Dropout, 300-mA Low-Noise, Low- I_q LDO

FEATURES

- Low Output Noise
- Low Dropout Voltage
- Thermal-Overload Protection
- 10nA Logic-Controlled Shutdown
- Available in Multiple Output Voltage Versions
- Fixed Outputs of 1.2V, 1.5V, 1.8V, 2.5V, 2.8V, 3.0V, 3.3V

APPLICATIONS

- Cellular Telephones
- Camera Modules
- Sensors
- HiFi Audio Radio Transceivers
- PLL/Synthesizer, Clocking
- Medium-Current, Noise-Sensitive Applications

DESCRIPTION

The RS3219 series low-power, low-dropout, CMOS LDO operate from 1.7V to 7.5V input voltage that can supply up to 300 mA of output current. Designed to meet the requirements of RF and analog circuits, the RS3219 series device provides low noise, high PSRR, low quiescent current, and low line and load transient response.

The device is designed to work with a 1- μ F input and a 1- μ F output ceramic capacitor.

Other features include a 10nA logic-controlled shutdown mode and thermal shutdown protection.

The RS3219 series is available in Green SOT23-3, SOT23-5 and UTDFN-1x1-4 packages. It operates over an ambient temperature range of -40°C to +85°C.

Functional Block Diagram

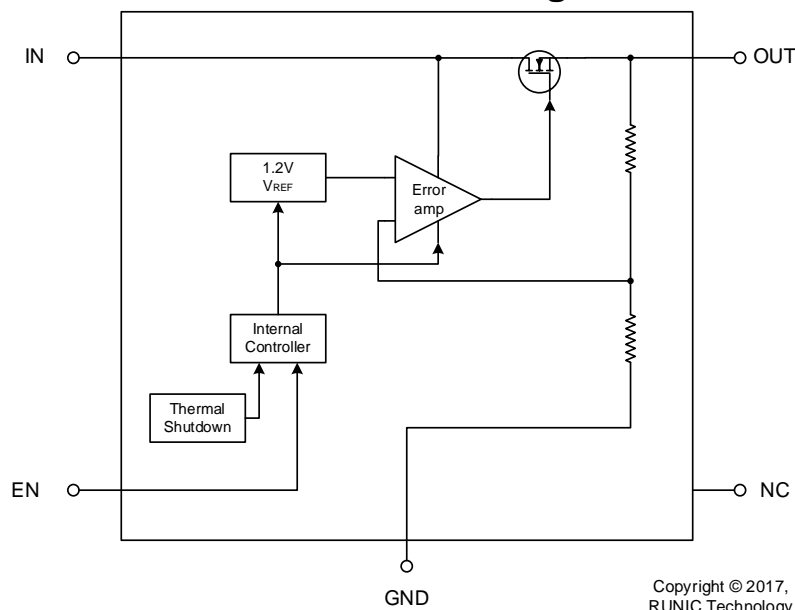

Pin Configuration and Functions (Top View)

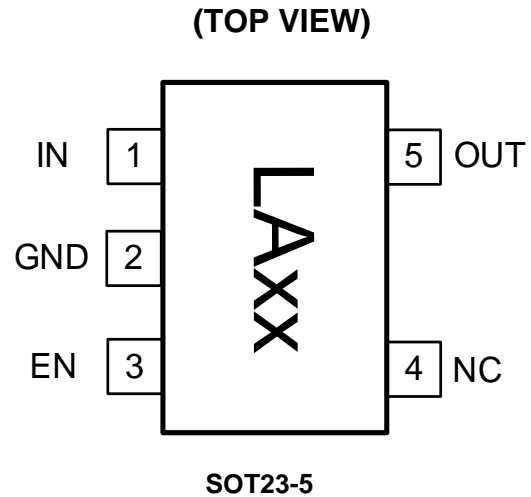
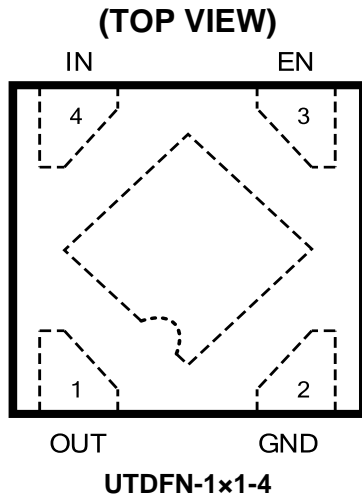

UTDFN-1x1-4		I/O	DESCRIPTION
NUMBER	NAME		
1	OUT	O	Regulator Output.
2	GND	G	Ground.
3	EN	I	Enable Input. A logic low reduces the supply current to 10nA. Connect to IN for normal operation.
4	IN	I	Regulator Input. Supply voltage can range from 1.7V to 7.5V. Bypass with a 1 μ F capacitor to GND.
Thermal Pad	-	-	Connect the thermal pad to a large-area ground plane. This pad is not an electrical connection to the device ground.

SOT23-5		I/O	DESCRIPTION
NUMBER	NAME		
1	IN	I	Regulator Input. Supply voltage can range from 1.7V to 7.5V. Bypass with a 1 μ F capacitor to GND.
2	GND	G	Ground.
3	EN	I	Enable Input. A logic low reduces the supply current to 10nA. Connect to IN for normal operation.
4	NC	-	No internal connect.
5	OUT	O	Regulator Output.

Pin Configuration and Functions (Top View)

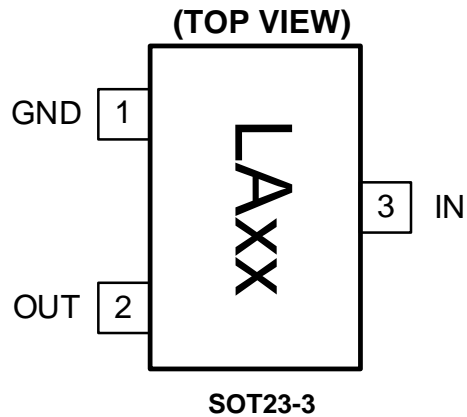

SOT23-3		I/O	DESCRIPTION
NUMBER	NAME		
1	GND	G	Ground.
2	OUT	O	Regulator Output.
3	IN	I	Regulator Input. Supply voltage can range from 1.7V to 7.5V. Bypass with a 1 μ F capacitor to GND.

PACKAGE/ORDERING INFORMATION

MODEL	V _{OUT} (V)	PIN- PACKAGE	ORDERING NUMBER	PACKAGE MARKING ⁽¹⁾	PACKAGE OPTION
RS3219-1.2	1.2V	UTDFN-1x1-4	RS3219-1.2YUTDN4	AC	Tape and Reel, 10000
RS3219-1.5	1.5V	UTDFN-1x1-4	RS3219-1.5YUTDN4	AD	Tape and Reel, 10000
RS3219-1.8	1.8V	UTDFN-1x1-4	RS3219-1.8YUTDN4	AE	Tape and Reel, 10000
RS3219-2.5	2.5V	UTDFN-1x1-4	RS3219-2.5YUTDN4	AG	Tape and Reel, 10000
RS3219-2.8	2.8V	UTDFN-1x1-4	RS3219-2.8YUTDN4	AH	Tape and Reel, 10000
RS3219-3.0	3.0V	UTDFN-1x1-4	RS3219-3.0YUTDN4	AI	Tape and Reel, 10000
RS3219-3.3	3.3V	UTDFN-1x1-4	RS3219-3.3YUTDN4	AJ	Tape and Reel, 10000
RS3219-1.2	1.2V	SOT23-5	RS3219-1.2YF5	LA12	Tape and Reel, 3000
RS3219-1.5	1.5V	SOT23-5	RS3219-1.5YF5	LA15	Tape and Reel, 3000
RS3219-1.8	1.8V	SOT23-5	RS3219-1.8YF5	LA18	Tape and Reel, 3000
RS3219-2.5	2.5V	SOT23-5	RS3219-2.5YF5	LA25	Tape and Reel, 3000
RS3219-2.8	2.8V	SOT23-5	RS3219-2.8YF5	LA28	Tape and Reel, 3000
RS3219-3.0	3.0V	SOT23-5	RS3219-3.0YF5	LA30	Tape and Reel, 3000
RS3219-3.3	3.3V	SOT23-5	RS3219-3.3YF5	LA33	Tape and Reel, 3000
RS3219-1.2	1.2V	SOT23-3	RS3219-1.2YF3	LA12	Tape and Reel, 3000
RS3219-1.5	1.5V	SOT23-3	RS3219-1.5YF3	LA15	Tape and Reel, 3000
RS3219-1.8	1.8V	SOT23-3	RS3219-1.8YF3	LA18	Tape and Reel, 3000
RS3219-2.5	2.5V	SOT23-3	RS3219-2.5YF3	LA25	Tape and Reel, 3000
RS3219-2.8	2.8V	SOT23-3	RS3219-2.8YF3	LA28	Tape and Reel, 3000
RS3219-3.0	3.0V	SOT23-3	RS3219-3.0YF3	LA30	Tape and Reel, 3000
RS3219-3.3	3.3V	SOT23-3	RS3219-3.3YF3	LA33	Tape and Reel, 3000

NOTE:

- (1) There may be additional marking, which relates to the lot trace code information(include data code and vendor code), the logo or the environmental category on the device.

Absolute Maximum Ratings

over operating free-air temperature range (unless otherwise noted)⁽¹⁾⁽²⁾

		MIN	MAX	UNIT
V _{IN}	Input voltage	-0.3	8	V
V _{OUT}	Output voltage	-0.3	V _{IN} + 0.3	V
V _{EN}	Enable input voltage	-0.3	V _{IN}	V
T _J	Junction temperature		150	°C
P _D	Continuous power dissipation ⁽³⁾	Internally Limited		W
T _{stg}	Storage temperature	-65	150	°C

(1) Stresses beyond those listed under *Absolute Maximum Ratings* may cause permanent damage to the device. These are stress ratings only, and functional operation of the device at these or any other conditions beyond those indicated under *Recommended Operating Conditions* is not implied. Exposure to absolute-maximum-rated conditions for extended periods may affect device reliability.

(2) All voltages are with respect to the GND pin.

(3) Internal thermal shutdown circuitry protects the device from permanent damage.

ESD Ratings

		VALUE	UNIT
V _(ESD)	Electrostatic discharge	Human-body model (HBM)	±6000
		Machine model (MM)	±500

Recommended Operating Conditions

over operating free-air temperature range (unless otherwise noted)⁽¹⁾

		MIN	MAX	UNIT
V _{IN}	Input supply voltage	1.7	7.5	V
V _{OUT}	Output voltage	1.2	5	V
V _{EN}	Enable input voltage	0	V _{IN}	V
I _{OUT}	Output current	0	300	mA
T _J	Junction temperature	-40	85	°C

(1) All voltages are with respect to the GND pin.

Thermal Information

	THERMAL METRIC	RS3219	RS3219	RS3219	UNIT
		SOT23-5	SOT23-3	UTDFN-1x1-4	
		5 PINS	3 PINS	4 PINS	
R _{θJA}	Junction-to-ambient thermal resistance	230	230	312.5	°C/W
R _{θJC(top)}	Junction-to-case (top) thermal resistance	150	150	137.9	°C/W
R _{θJB}	Junction-to-board thermal resistance	55	55	83.5	°C/W
ψ _{JT}	Junction-to-top characterization parameter	30	30	5.3	°C/W
ψ _{JB}	Junction-to-board characterization parameter	55	55	83.8	°C/W
R _{JC(bot)}	Junction-to-case (bottom) thermal resistance	N/A	N/A	71.8	°C/W

ELECTRICAL CHARACTERISTICS

($V_{IN} = V_{OUT (NOMINAL)} + 0.5V$ ⁽¹⁾, Full = -40°C to +85°C, unless otherwise noted.)

PARAMETER	SYMBOL	CONDITIONS	TEMP	MIN	TYP	MAX	UNITS	
Input Voltage	V_{IN}		+25°C	1.7 ⁽¹⁾		7.5	V	
Output Voltage Accuracy ⁽¹⁾		$I_{OUT} = 0.1mA$	+25°C	-2.5		+2.5	%	
Maximum Output Current ⁽¹⁾			+25°C	300			mA	
Ground Pin Current	I_Q	No load, $EN = V_{IN}$	+25°C		120	200	μA	
Dropout Voltage ⁽²⁾		$I_{OUT} = 1mA$, $V_{OUT}=3.3V$	+25°C		0.95		mV	
		$I_{OUT} = 300mA$, $V_{OUT}=3.3V$			280	400		
Line Regulation ⁽¹⁾	ΔV_{LNR}	$V_{IN} = 1.7V$ or ($V_{OUT} + 0.5V$) to 5.5V, $I_{OUT} = 1mA$	+25°C		0.03	0.09	%/V	
Load Regulation	ΔV_{LDR}	$I_{OUT} = 0.1mA$ to 300mA, $C_{OUT} = 1\mu F$,	+25°C		0.002	0.005	%/mA	
Output Voltage Noise	e_n	$f = 0.1Hz$ to 10Hz, $C_{OUT} = 1\mu F$	+25°C		38		μV_{PP}	
Power Supply Rejection Ratio	PSRR	$I_{LOAD} = 50mA$, $C_{OUT} = 1\mu F$, $V_{IN} = V_{OUT}+1V$	$f = 217Hz$	+25°C		56		dB
			$f = 1kHz$	+25°C		55		dB
SHUTDOWN ⁽³⁾								
EN Input Threshold	V_{IH}	$V_{IN} = 1.7V$	Full		1.4		V	
	V_{IL}		Full			0.3		
	V_{IH}	$V_{IN} = 7.5V$	Full		2.0		V	
	V_{IL}		Full			0.3		
EN Input Bias Current	$I_{B(SHDN)}$	$EN = 0V$ or $EN = V_{IN}$	+25°C		0.01	1	μA	
			Full		0.01			
Shutdown Supply Current	$I_{Q(SHDN)}$	$EN = 0.4V$	Full		0.01		μA	
Shutdown Exit Delay ⁽⁴⁾		$C_{OUT} = 1\mu F$, No Load	+25°C		50		μs	
THERMAL PROTECTION								
Thermal Shutdown Temperature	T_{SHDN}				150		°C	
Thermal Shutdown Hysteresis	ΔT_{SHDN}				15		°C	

NOTES:

- $V_{IN} = V_{OUT (NOMINAL)} + 0.5V$ or 1.7V, whichever is greater.
- The dropout voltage is defined as $V_{IN} - V_{OUT}$, when V_{OUT} is 100mV below the value of V_{OUT} for $V_{IN} = V_{OUT} + 0.5V$.
(Only applicable for $V_{OUT} = +1.2V$ to +5.0V.)
- $V_{EN} = -0.3V$ to V_{IN}
- Time needed for V_{OUT} to reach 90% of final value.

TYPICAL APPLICATION CIRCUIT

5Pin Typical Circuit

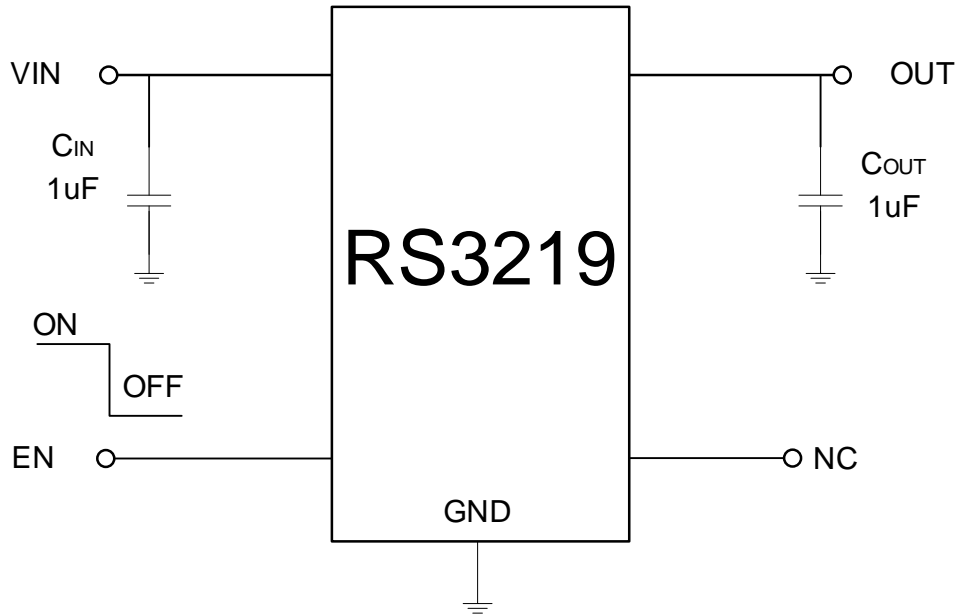

3Pin Typical Circuit

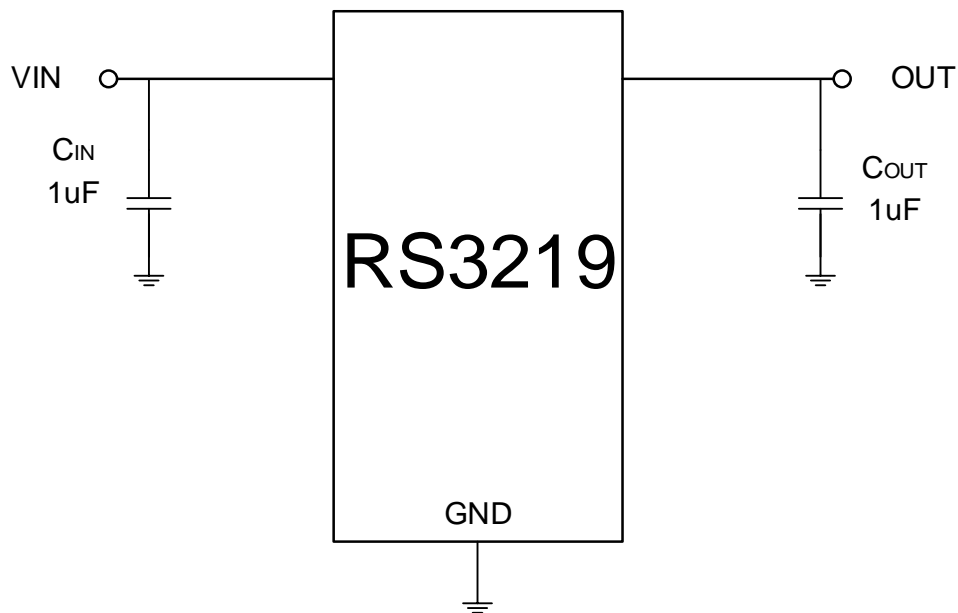

TYPICAL PERFORMANCE CHARACTERISTICS

$V_{IN} = V_{OUT} (\text{NOMINAL}) + 0.5V$, $C_{IN} = 1\mu F$, $C_{OUT} = 1\mu F$, $T_A = +25^\circ C$, unless otherwise noted.

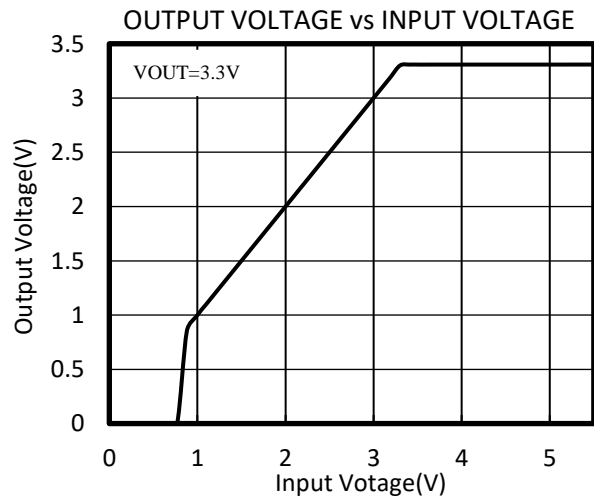
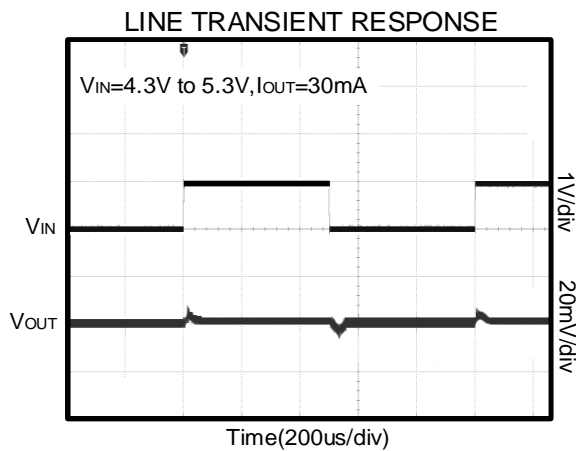
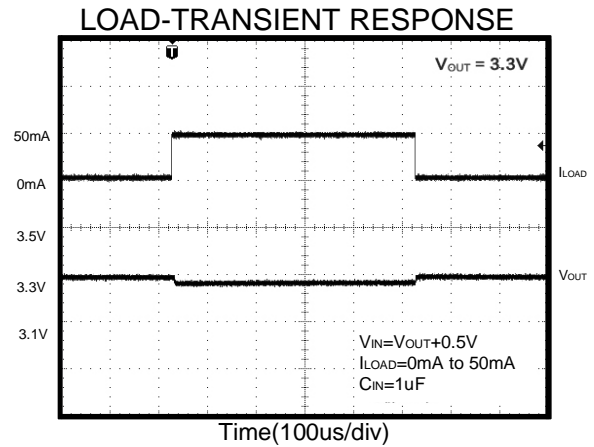
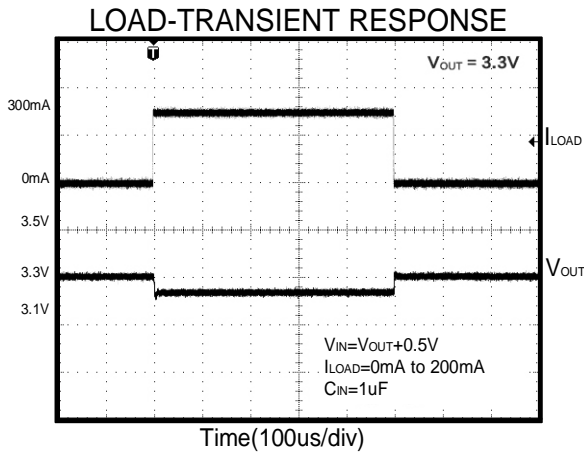
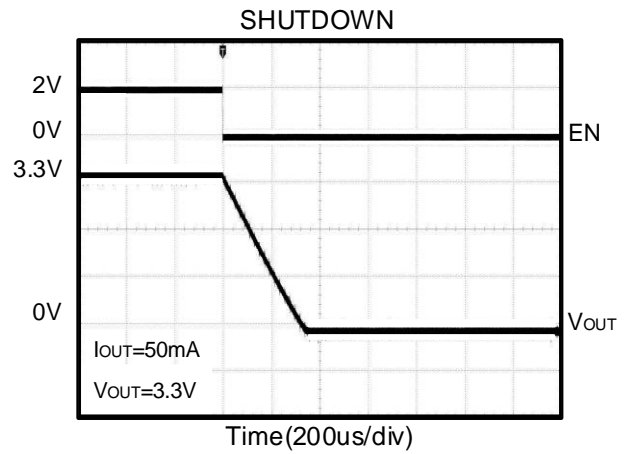
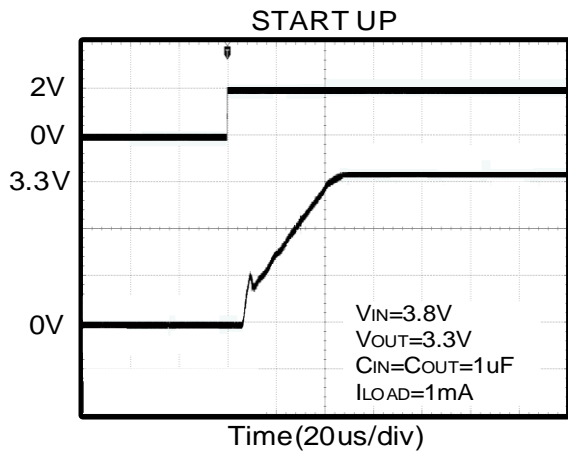

TYPICAL PERFORMANCE CHARACTERISTICS

$V_{IN} = V_{OUT} \text{ (NOMINAL)} + 0.5V$, $C_{IN} = 1\mu F$, $C_{OUT} = 1\mu F$, $T_A = +25^\circ C$, unless otherwise noted.

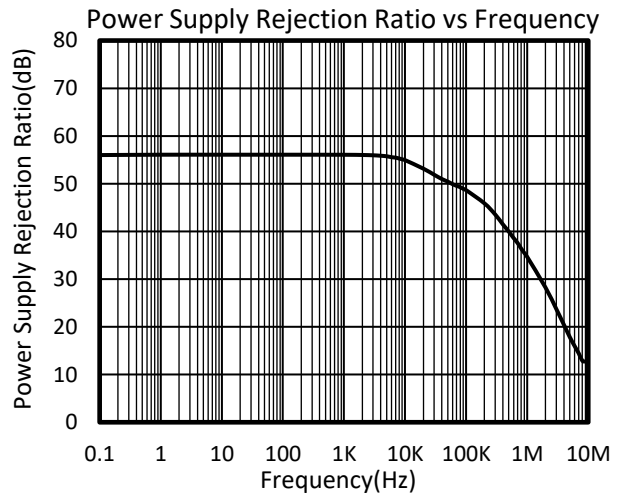
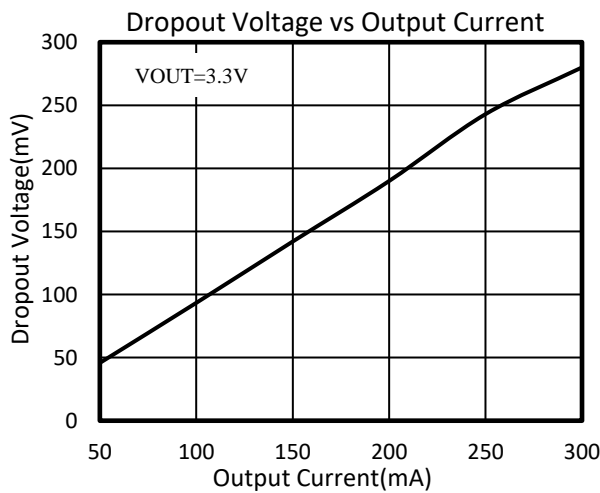
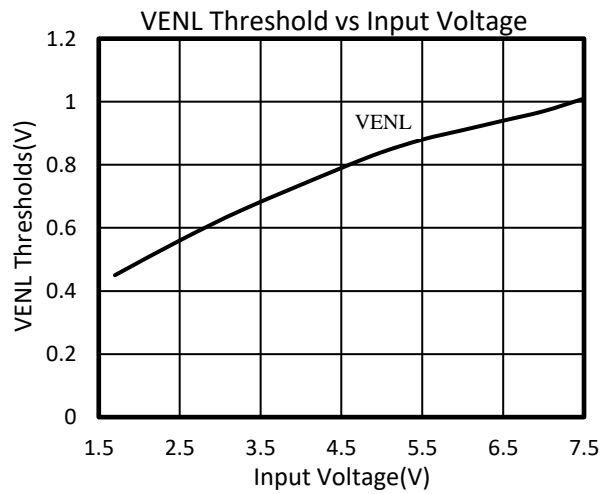
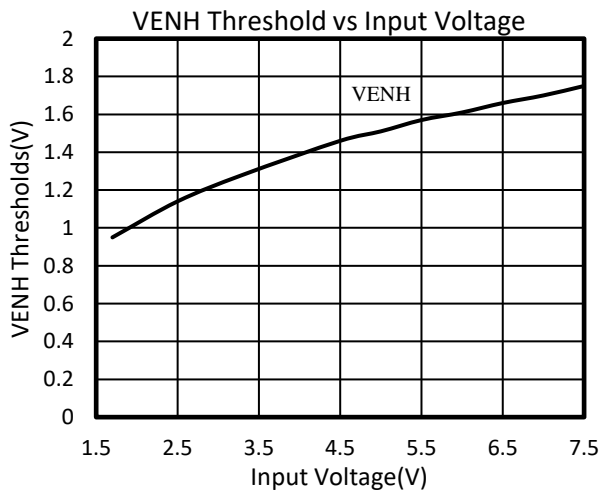
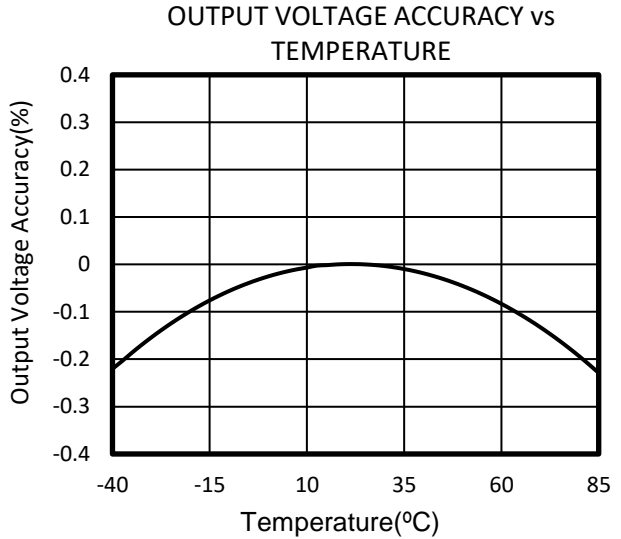
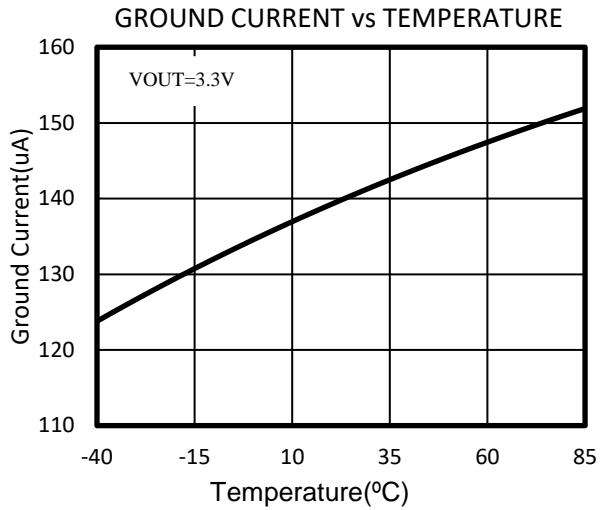

TYPICAL PERFORMANCE CHARACTERISTICS

$V_{IN} = V_{OUT} (NOMINAL) + 0.5V$, $C_{IN} = 1\mu F$, $C_{OUT} = 1\mu F$, $T_A = +25^\circ C$, unless otherwise noted.

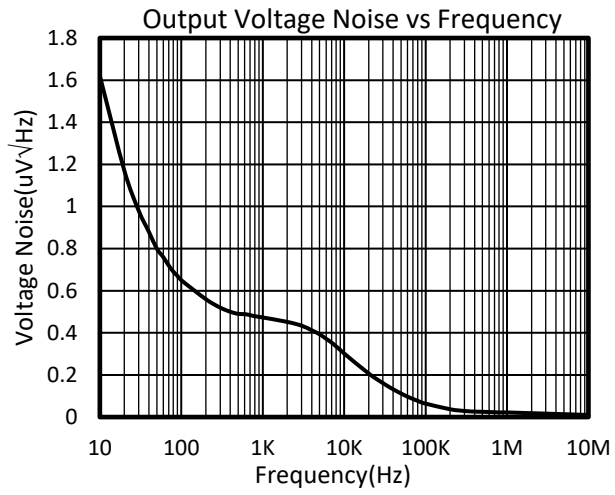

PACKAGE OUTLINE DIMENSIONS

SOT23-3

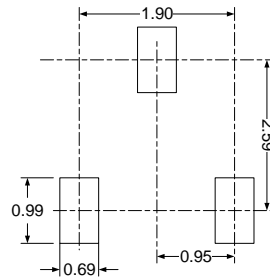
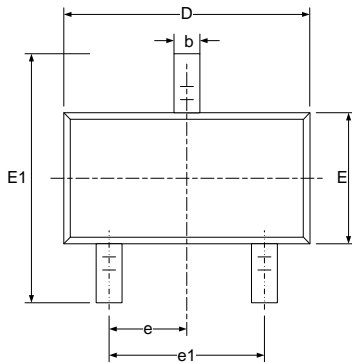
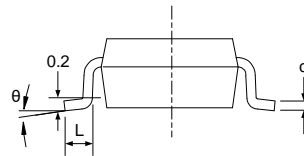
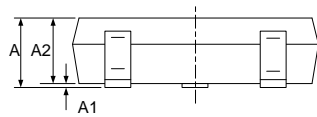

RECOMMENDED LAND PATTERN (Unit: mm)

Symbol	Dimensions In Millimeters		Dimensions In Inches	
	Min	Max	Min	Max
A	1.050	1.250	0.041	0.049
A1	0.000	0.100	0.000	0.004
A2	1.050	1.150	0.041	0.045
b	0.300	0.500	0.012	0.020
c	0.100	0.200	0.004	0.008
D	2.820	3.020	0.111	0.119
E	1.500	1.700	0.059	0.067
E1	2.650	2.950	0.104	0.116
e	0.950(BSC)		0.037(BSC)	
e1	1.800	2.000	0.071	0.079
L	0.300	0.600	0.012	0.024
θ	0°	8°	0°	8°

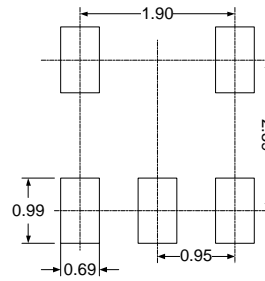
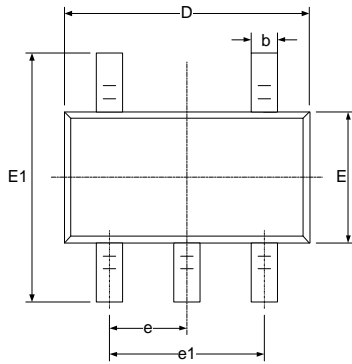
SOT23-5

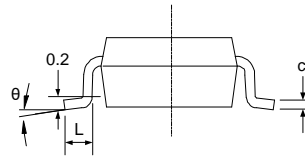
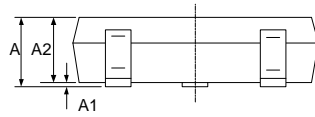

RECOMMENDED LAND PATTERN (Unit: mm)



Symbol	Dimensions In Millimeters		Dimensions In Inches	
	Min	Max	Min	Max
A	1.050	1.250	0.041	0.049
A1	0.000	0.100	0.000	0.004
A2	1.050	1.150	0.041	0.045
b	0.300	0.500	0.012	0.020
c	0.100	0.200	0.004	0.008
D	2.820	3.020	0.111	0.119
E	1.500	1.700	0.059	0.067
E1	2.650	2.950	0.104	0.116
e	0.950(BSC)		0.037(BSC)	
e1	1.800	2.000	0.071	0.079
L	0.300	0.600	0.012	0.024
θ	0°	8°	0°	8°

