

Solderless terminals

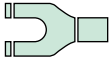

FLANGED SPADE TONGUE (B type) Non-insulated

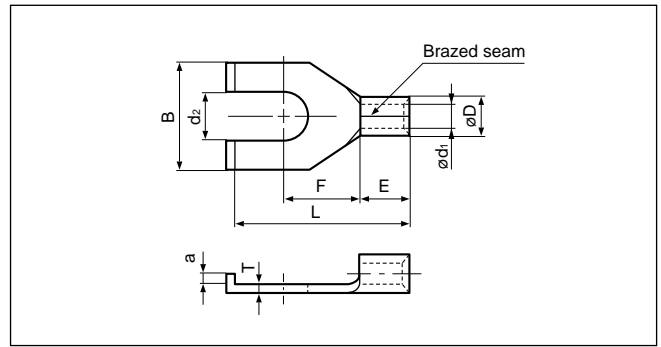
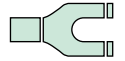

Certificate No.: E42024 LR20812

Applicable Wire AWG# (mm ²)	Stud size		Part No.	Standard	Dimensions mm (in.)										Tool No.	Qty/box
	American	Metric			dz	B	L	F	E	øD	ød1	a	T			
22 to 16 (0.25 to 1.65)	5-6	3.5	1.25-YS3B		3.7 (.146)	6.4 (.252)	14.2 (.559)	6.3 (.248)	4.8 (.189)	3.4 (.134)	1.7 (.067)	0.8 (.031)	0.8 (.031)	YHT-2210 YA-1 YA-2 YA-4 BCT-0514L	1,000	
	5-6	3.5	1.25-S3B		3.7 (.146)	7.5 (.295)	13.1 (.516)	5.1 (.201)				1.5 (.059)				
	8	4	1.25-YS4B		4.3 (.169)	6.4 (.252)	14.2 (.559)	6.3 (.248)				0.8 (.031)				
	8	4	1.25-S4B		4.3 (.169)	7.5 (.295)	13.1 (.516)	5.1 (.201)				1.5 (.059)				
	8	4	1.25-4B		4.3 (.169)	8.5 (.335)	18.5 (.728)	7.2 (.284)								
	10	5	1.25-5B		5.3 (.209)	8.5 (.335)	18.5 (.728)	7.2 (.284)								
16 to 14 (1.04 to 2.63)	5-6	3.5	2-T3B		3.7 (.146)	7.5 (.295)	13.5 (.532)	5.2 (.205)	4.8 (.189)	4.1 (.161)	2.3 (.091)	1.5 (.059)	0.8 (.031)	YHT-2210 YA-1 YA-2 YA-4 BCT-0514L	1,000	
	5-6	3.5	2-3B		3.7 (.146)	8.5 (.335)	17.0 (.670)	7.2 (.283)				1.5 (.059)				
	8	4	2-T4B		4.3 (.169)	7.5 (.295)	13.5 (.532)	5.2 (.205)				1.5 (.059)				
	8	4	2-4B		4.3 (.169)	8.5 (.335)	17.0 (.670)	7.3 (.287)								
	10	5	2-5B		5.3 (.209)	8.5 (.335)	17.0 (.670)	7.3 (.287)								
	1/4	6	2-6B		6.4 (.252)	13.5 (.532)	24.0 (.945)	11.7 (.461)								
12 to 10 (2.63 to 6.64)	5-6	3.5	5.5-S3B		3.7 (.146)	7.6 (.299)	18.0 (.709)	6.2 (.244)	6.8 (.268)	5.6 (.221)	3.4 (.134)	1.5 (.059)	1.0 (.039)	YHT-2210 YA-1 YA-2 YA-4 BCT-0514L	500	
	5-6	3.5	5.5-3B		3.7 (.146)	8.5 (.335)	19.5 (.768)	7.5 (.295)				1.5 (.059)				
	8	4	5.5-S4B		4.3 (.169)	7.6 (.299)	18.0 (.709)	6.2 (.244)				1.5 (.059)				
	8	4	5.5-4B		4.3 (.169)	8.5 (.335)	19.5 (.768)	7.5 (.295)								
	10	5	5.5-5B		5.3 (.209)	8.5 (.335)	19.5 (.768)	7.5 (.295)								
	1/4	6	5.5-6B		6.4 (.252)	13.5 (.532)	26.5 (1.043)	12.2 (.480)								

Note:1) The part numbers indicated in the above table are for products with a brazed seam.
 When ordering products with a butted seam, add the prefix "WS" to the part number (ex. 2-4B → **WS2-4B**).
 2) Delivery lead times may vary depending on the product. Contact JST for details.

Solderless terminals

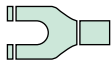

FLANGED SPADE TONGUE (B type) vinyl-insulated

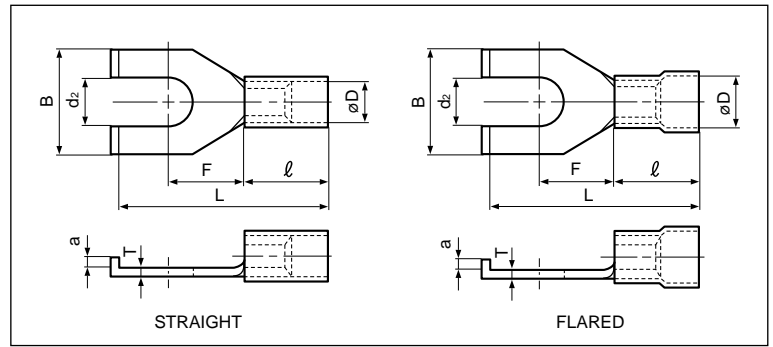
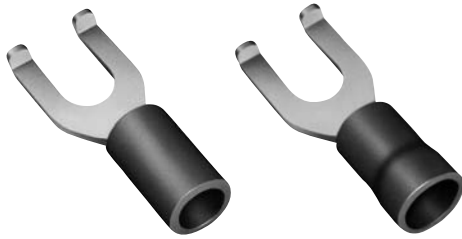
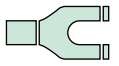

Certificate No.:

Applicable Wire AWG#(mm ²)	Stud size		Part No.		Standard	Dimensions mm (in.)										Color	Tool No.	Qty/box
	American	Metric	Straight	Flared		d ₂	B	L	F	a	ℓ	ø D		T				
												Str.	Fl.					
26 to 22 (0.2 to 0.5)	1-2	2	V0.5-2B	FV0.5-2B		2.2 (.087)	4.6 (.181)	15.6 (.614)	4.5 (.177)	1.0 (.039)	8.0 (.315)	1.9 (.075)	2.9 (.114)	0.5 (.020)	Yellow	YNT-2622 YA-1, YA-2 BCT-0514L	1,000	
22 to 16 *(0.25 to 1.65)	5-6	3.5	V1.25-S3B	FV1.25-S3B		3.7 (.146)	7.5 (.295)	17.3 (.681)	5.1 (.201)	1.5 (.059)	9.0 (.354)	3.2 (.126)	4.0 (.157)	0.8 (.031)	Red	YNT-2216 YA-1 YA-2 YA-4 BCT-0514L	1,000	
	5-6	3.5	V1.25-3B	FV1.25-3B		3.7 (.146)	8.5 (.335)	21.7 (.854)	7.2 (.284)									
	8	4	V1.25-YS4B	-		4.3 (.169)	6.4 (.252)	18.4 (.724)	6.3 (.248)									
	8	4	V1.25-S4B	FV1.25-S4B		4.3 (.169)	7.5 (.295)	17.3 (.681)	5.1 (.201)									
	8	4	V1.25-4B	FV1.25-4B		4.3 (.169)	8.5 (.335)	22.7 (.894)	7.2 (.284)									
	10	5	V1.25-5B	FV1.25-5B		5.3 (.209)	8.5 (.335)	22.7 (.894)	7.2 (.284)									
	1/4	6	V1.25-6B	FV1.25-6B		6.4 (.252)	13.5 (.532)	28.2(1.110)	11.7 (.461)	1.5 (.059)							500	
16 to 14 (1.04 to 2.63)	5-6	3.5	V2-YS3B	-		3.7 (.146)	6.4 (.252)	18.6 (.732)	6.3 (.248)	1.5 (.059)	9.0 (.354)	3.9 (.154)	4.5 (.177)	0.8 (.031)	Blue	YNT-1614 YA-1 YA-2 YA-4 BCT-0514L	1,000	
	5-6	3.5	V2-T3B	FV2-T3B		3.7 (.146)	7.5 (.295)	17.7 (.697)	5.2 (.205)									
	5-6	3.5	V2-S3B	-		3.7 (.146)	8.5 (.335)	19.0 (.748)	7.2 (.284)									
	5-6	3.5	V2-3B	FV2-3B		3.7 (.146)	8.5 (.335)	21.2 (.835)	7.2 (.284)									
	8	4	V2-T4B	FV2-T4B		4.3 (.169)	7.5 (.295)	17.7 (.696)	5.2 (.205)									
	8	4	V2-S4B	-		4.3 (.169)	8.5 (.335)	19.0 (.748)	7.2 (.284)									
	8	4	V2-E4B	FV2-E4B		4.3 (.169)	8.5 (.335)	19.4 (.764)	7.3 (.287)									
	8	4	V2-4B	FV2-4B		4.3 (.169)	8.5 (.335)	21.2 (.835)	7.3 (.287)									
	10	5	V2-5B	FV2-5B		5.3 (.209)	8.5 (.335)	21.2 (.835)	7.3 (.287)									
1/4	6	V2-6B	FV2-6B	6.4 (.252)	13.5 (.532)	28.2(1.110)	11.7 (.461)	1.5 (.059)	500									
12 to 10 (2.63 to 6.64)	5-6	3.5	V5.5-S3B	FV5.5-S3B		3.7 (.146)	7.6 (.299)	24.7 (.972)	6.2 (.244)	1.5 (.059)	13.5 (.531)	5.4 (.213)	6.8 (.268)	1.0 (.039)	Yellow	YNT-1210S YA-4 BCT-0514L	500	
	5-6	3.5	V5.5-3B	-		3.7 (.146)	8.5 (.335)	26.2(1.032)	7.5 (.295)									
	8	4	V5.5-S4B	FV5.5-S4B		4.3 (.169)	7.6 (.299)	24.7 (.972)	6.2 (.244)									
	8	4	V5.5-4B	FV5.5-4B		4.3 (.169)	8.5 (.335)	26.2(1.032)	7.5 (.295)									
	10	5	V5.5-S5B	FV5.5-S5B		5.3 (.209)	7.6 (.299)	24.7 (.972)	6.2 (.244)									
	10	5	V5.5-5B	FV5.5-5B		5.3 (.209)	8.5 (.335)	26.2(1.032)	7.5 (.295)									
	10	5	V5.5-E5B	FV5.5-E5B		5.3 (.209)	9.5 (.374)	24.2 (.953)	7.5 (.295)									
	1/4	6	-	FV5.5-6B		6.4 (.252)	13.5 (.532)	33.2(1.307)	12.2 (.480)	1.5 (.059)							250	

- Note: 1) *The crimping will be more secure if the total cross-sectional area of the wire is at least 0.5 mm².
 Examples: If the cross-sectional area of the wire is 0.3 mm², fold the wire in two when crimping the terminal.
 If the cross-sectional area of the wire is 0.5 mm², crimp the terminal onto the wire as it is.
- 2) The part numbers indicated in the above table are for products with a brazed seam.
 When ordering products with a butted seam, add the prefix "WS" to the part number (ex. V2-4B → **VWS2-4B**).
- 3) To order products with nylon insulation, change the "V" in the part number prefix to "N" (ex. V2-T4B → **N2-T4B**).
 Because nylon absorbs moisture, care must be taken concerning storage.
- 4) Delivery lead times may vary depending on the product. Contact JST for details.

Solderless terminals



FLANGED SPADE TONGUE (B type) Vinyl-insulated (funnel-entry)

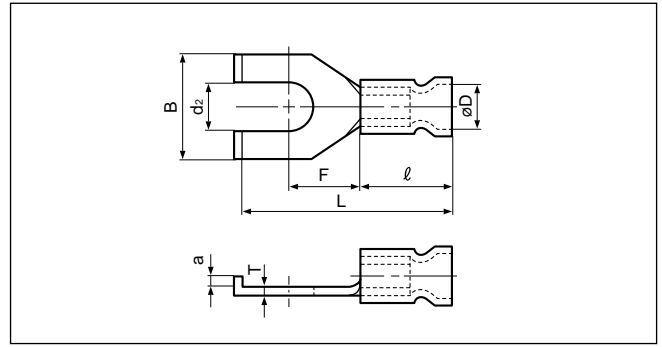
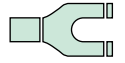

Certificate No.: E42024 LR20812

Applicable Wire AWG#(mm²)	Stud size		Part No.	Standard	Dimensions mm (in.)								Color	Tool No.	Qty/box
	American	Metric			d ₂	B	L	F	a	ℓ	ø D	T			
22 to 16 *(0.25 to 1.65)	1/4	6	FVX1.25-6B		6.4 (.252)	13.5 (.531)	30.0(1.181)	11.7 (.461)	1.5 (.059)	10.8 (.425)	4.0 (.157)	0.8 (.031)	Red	YNT-2216 YA-1 YA-2 YA-4 BCT-0514L	—
16 to 14 (1.04 to 2.63)	5-6	3.5	FVX2-T3B		3.7 (.146)	7.5 (.295)	19.5 (.768)	5.2 (.205)	1.5 (.059)	10.8 (.425)	4.6 (.181)	0.8 (.031)	Blue	YNT-1614 YA-1 YA-2 YA-4 BCT-0514L	1,000
	8	4	FVX2-T4B		4.3 (.169)	7.5 (.295)	19.5 (.768)	5.2 (.205)							
	8	4	FVX2-E4B		4.3 (.169)	8.5 (.335)	21.2 (.835)	7.3 (.287)	1.0 (.039)						
	1/4	6	FVX2-6B		6.4 (.252)	13.5 (.531)	30.0(1.181)	11.7 (.461)	1.5 (.059)						
12 to 10 (2.63 to 6.64)	10	5	FVX5.5-E5B		5.3 (.209)	9.6 (.378)	24.7 (.972)	7.5 (.295)	1.5 (.059)	14.0 (.551)	6.8 (.268)	1.0 (.039)	Yellow	YNT-1210S YA-4 BCT-0514L	500

- Note:1) The part numbers indicated in the above table are for products with a brazed seam.
 When ordering products with a butted seam, add the prefix "WS" to the part number (ex. FVX2-4B → **FVXWS2-4B**).
- 2) *The crimping will be more secure if the total cross-sectional area of the wire is at least 0.5 mm².
 Examples: If the cross-sectional area of the wire is 0.3 mm², fold the wire in two when crimping the terminal.
 If the cross-sectional area of the wire is 0.5 mm², crimp the terminal onto the wire as it is.
- 3) Delivery lead times may vary depending on the product. Contact JST for details.

Solderless terminals



FLANGED SPADE TONGUE (B type) Vinyl-insulated with copper sleeve

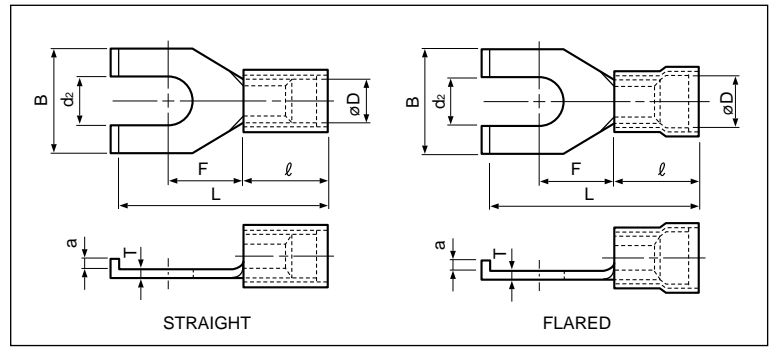
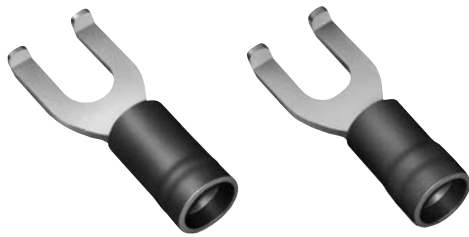
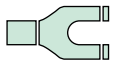

Certificate No.: E42024 LR20812

Applicable Wire AWG#(mm ²)	Stud size		Part No.		Standard	Dimensions mm (in.)										Color	Tool No.	Qty/box
	American	Metric	Straight	Flared		d ₂	B	L	F	a	ℓ	ø D		T				
												Str.	Fld.					
26 to 22 (0.2 to 0.5)	1-2	2	VD0.5-2B	-		2.2 (.087)	4.6 (.181)	15.6 (.614)	4.5 (.177)	1.0 (.039)	8.0 (.315)	2.2 (.087)	2.5 (.098)	0.5 (.020)	Yellow	YNT-2622 YA-1, YA-2 BCT-0514L	1,000	
22 to 16 (0.25 to 1.65)	5-6	3.5	VD1.25-YS3B	-		3.7 (.146)	6.4 (.252)	19.0 (.748)	6.3 (.248)	0.8 (.031)	9.6 (.378)	3.5 (.138)	4.0 (.157)	0.8 (.031)	Red	YNT-2216 YA-1 YA-2 YA-4 BCT-0514L	1,000	
	5-6	3.5	VD1.25-S3B	FVD1.25-S3B		3.7 (.146)	7.5 (.295)	17.9 (.705)	5.1 (.201)	1.5 (.059)								
	5-6	3.5	VD1.25-3B	FVD1.25-3B		3.7 (.146)	8.5 (.335)	22.3 (.878)	7.2 (.283)	0.8 (.031)								
	8	4	VD1.25-YS4B	-		4.3 (.169)	6.4 (.252)	19.0 (.748)	6.3 (.248)	0.8 (.031)								
	8	4	VD1.25-S4B	FVD1.25-S4B		4.3 (.169)	7.5 (.295)	17.9 (.705)	5.1 (.201)	1.5 (.059)								
	8	4	VD1.25-4B	FVD1.25-4B		4.3 (.169)	8.5 (.335)	23.3 (.917)	7.2 (.283)	0.8 (.031)								
	10	5	VD1.25-5B	FVD1.25-5B		5.3 (.209)	8.5 (.335)	23.3 (.917)	7.2 (.283)	1.5 (.059)								
1/4	6	VD1.25-6B	FVD1.25-6B	6.4 (.252)	13.5 (.531)	28.8(1.134)	11.7 (.461)	0.8 (.031)	500									
16 to 14 (1.04 to 2.63)	5-6	3.5	VD2-YS3B	-		3.7 (.146)	6.4 (.252)	19.2 (.756)	6.3 (.248)	0.8 (.031)	9.6 (.378)	4.1 (.161)	4.7 (.185)	0.8 (.031)	Blue	YNT-1614 YA-1 YA-2 YA-4 BCT-0514L	1,000	
	5-6	3.5	VD2-T3B	FVD2-T3B		3.7 (.146)	7.5 (.295)	18.3 (.720)	5.2 (.205)	1.5 (.059)								
	5-6	3.5	VD2-S3B	-		3.7 (.146)	8.5 (.335)	19.6 (.772)	7.2 (.283)	0.8 (.031)								
	5-6	3.5	VD2-3B	FVD2-3B		3.7 (.146)	8.5 (.335)	21.8 (.858)	7.2 (.283)	1.5 (.059)								
	8	4	VD2-T4B	-		4.3 (.169)	7.5 (.295)	18.3 (.720)	5.2 (.205)	0.8 (.031)								
	8	4	VD2-S4B	-		4.3 (.169)	8.5 (.335)	19.6 (.772)	7.2 (.283)	1.5 (.059)								
	8	4	VD2-E4B	-		4.3 (.169)	8.5 (.335)	20.0 (.787)	7.3 (.287)	0.8 (.031)								
	8	4	VD2-4B	FVD2-4B		4.3 (.169)	8.5 (.335)	21.8 (.858)	7.3 (.287)	1.5 (.059)								
10	5	VD2-5B	FVD2-5B	5.3 (.209)	8.5 (.335)	21.8 (.858)	7.3 (.287)	0.8 (.031)	500									
1/4	6	VD2-6B	FVD2-6B	6.4 (.252)	13.5 (.531)	28.8(1.134)	11.7 (.461)	1.5 (.059)	500									
12 to 10 (2.63 to 6.64)	5-6	3.5	VD5.5-S3B	FVD5.5-S3B		3.7 (.146)	7.6 (.299)	25.2 (.992)	6.2 (.244)	1.5 (.059)	14.0 (.551)	5.7 (.224)	6.5 (.256)	1.0 (.039)	Yellow	YNT-1210S YA-4 BCT-0514L	500	
	5-6	3.5	VD5.5-3B	FVD5.5-3B		3.7 (.146)	8.5 (.335)	26.7(1.051)	7.5 (.295)									
	8	4	VD5.5-S4B	FVD5.5-S4B		4.3 (.169)	7.6 (.299)	25.2 (.992)	6.2 (.244)									
	8	4	VD5.5-4B	-		4.3 (.169)	8.5 (.335)	26.7(1.051)	7.5 (.295)									
	10	5	VD5.5-5B	FVD5.5-5B		5.3 (.209)	8.5 (.335)	26.7(1.051)	7.5 (.295)									
	10	5	VD5.5-E5B	FVD5.5-E5B		5.3 (.209)	9.5 (.374)	24.7 (.972)	7.5 (.295)									
	1/4	6	VD5.5-6B	FVD5.5-6B		6.4 (.252)	13.5 (.531)	33.7(1.367)	12.2 (.480)								1.5 (.059)	250

Note: 1) The part numbers indicated in the above table are for products with a brazed seam.
 When ordering products with a butted seam, add the prefix "WS" to the part number (ex. FVD2-4B → **FVDWS2-4B**).
 2) To order products with nylon insulation, change the "V" in the part number prefix to "N" (ex. VD2-4B → **ND2-4B**).
 Because nylon absorbs moisture, care must be taken concerning storage.
 3) Delivery lead times may vary depending on the product. Contact JST for details.