

TLE4997A8(D)

Programmable Single/Dual Die Linear Hall Sensor

Data Sheet

Revision 1.1, 2018-01

Edition 2018-01

**Published by
Infineon Technologies AG
81726 Munich, Germany**

**© 2018 Infineon Technologies AG
All Rights Reserved.**

Legal Disclaimer

The information given in this document shall in no event be regarded as a guarantee of conditions or characteristics. With respect to any examples or hints given herein, any typical values stated herein and/or any information regarding the application of the device, Infineon Technologies hereby disclaims any and all warranties and liabilities of any kind, including without limitation, warranties of non-infringement of intellectual property rights of any third party.

Information

For further information on technology, delivery terms and conditions and prices, please contact the nearest Infineon Technologies Office (www.infineon.com).

Warnings

Due to technical requirements, components may contain dangerous substances. For information on the types in question, please contact the nearest Infineon Technologies Office.

Infineon Technologies components may be used in life-support devices or systems only with the express written approval of Infineon Technologies, if a failure of such components can reasonably be expected to cause the failure of that life-support device or system or to affect the safety or effectiveness of that device or system. Life support devices or systems are intended to be implanted in the human body or to support and/or maintain and sustain and/or protect human life. If they fail, it is reasonable to assume that the health of the user or other persons may be endangered.

Table of Contents

	Table of Contents	3
1	Overview	4
1.1	Features	4
1.2	Target Applications	5
1.3	Pin Configuration	5
2	General	6
2.1	Block Diagram	6
2.2	Functional Description	6
2.3	Principle of Operation	7
2.4	Transfer Functions	7
3	Maximum Ratings	8
4	Operating Range	9
5	Electrical, Thermal and Magnetic Parameters	10
5.1	Electrical Characteristics	10
5.2	Magnetic Characteristics	12
5.3	Magnetic Field Direction Definition	13
6	Application Circuit	14
7	Configuration and Calibration Parameters	15
8	Error Detection	18
8.1	Voltages Outside the Operating Range	18
8.2	Open Circuit of Supply Lines	18
8.3	Not Correctable EEPROM Errors	18
9	PG-TDSO-8 Package Outlines	19
9.1	Distance Chip to package	19
9.2	Moisture Sensitivity Level (MSL)	19
10	PG-TDSO-8 Package Marking	20

1 Overview



Characteristic	Supply Voltage	Supply Current	Magnetic Range	Interface	Temperature
Programmable Single/ Dual Die Linear Hall Sensor	4.5~5.5 V	7.5 mA	±50mT ±100mT ±200mT	Analog Ratiometric Output	-40°C to 125°C

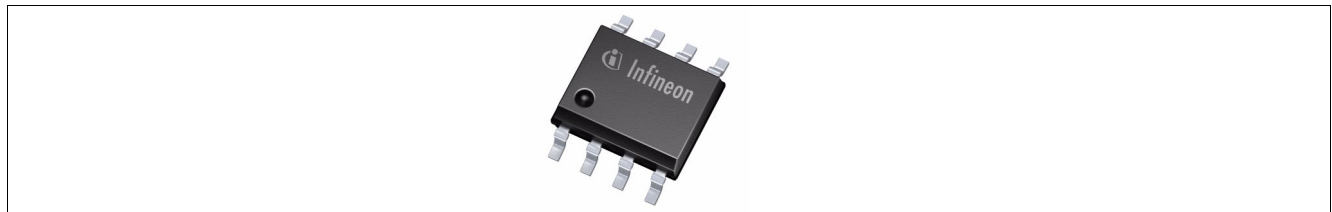

Figure 1-1 SMD package PG-TDSO-8 for the TLE4997A8(D)

1.1 Features

- Integration of two individual programmable Linear Hall sensor IC's with ratiometric analog output signal.
- 20-bit Digital Signal Processing (DSP)
- Digital temperature compensation
- 12-bit overall resolution
- Operating automotive temperature range -40°C to 125°C
- Low drift of output signal over temperature and lifetime
- Programmable parameters stored in EEPROM with single-bit error correction:
 - Magnetic range and sensitivity (gain), polarity of the output slope
 - Offset
 - Bandwidth
 - Clamping levels
 - Temperature compensation coefficients to accomodate most common magnet materials
 - Memory lock
- Supply voltage 4.5-5.5 V (4-7 V extended range)
- Configurable magnetic range : ±50mT, ±100mT or ±200mT
- Reverse-polarity and overvoltage protection for all pins
- Output short-circuit protection
- On-board diagnostics (wire breakage detection, EEPROM error, overvoltage)
- Digital readout of internal temperature and magnetic field values in calibration mode
- Programming and operation of multiple sensors with common power supply
- Two-point calibration of magnetic transfer function

Note: Product qualification is based on "AEC Q100" grade 1 (Automotive Electronics Council - Stress test qualification for integrated circuits)

Table 1-1 Ordering Information

Product Name	Marking	Ordering Code	Package
TLE4997A8	A8S	SP001215464	single sensor, PG-TDSO-8
TLE4997A8D	A8D	SP000902760	dual sensor, PG-TDSO-8

1.2 Target Applications

- Robust replacement of potentiometers: No mechanical abrasion, resistant to humidity, temperature, pollution and vibration
- Linear and angular position sensing in automotive and industrial applications with highest accuracy requirements
- Suited for ASIL applications such as pedal position, throttle position and steering torque sensing

1.3 Pin Configuration

Figure 1-2 shows the location of the Hall elements in the chip pin configuration of the package.

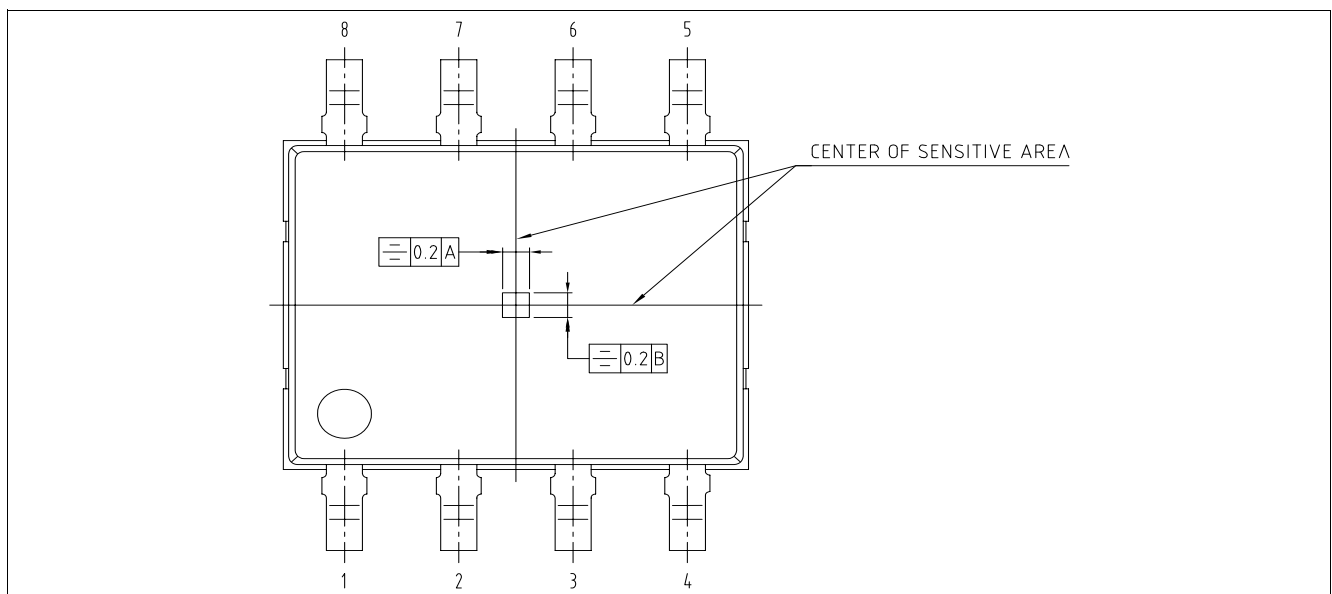

Figure 1-2 Pin Configuration of PG-TDSO-8 package

Table 1-2 TLE4997A8(D) Pin Definitions and Functions

Pin No.	Symbol	TLE4997A8 Function	TLE4997A8D Function
1	n/c	not connected (connection to GND is recommended)	not connected (connection to GND is recommended)
2	V_{DD}	Supply voltage / programming interface	Supply voltage / programming interface (top die)
3	GND	Ground	Ground (top die)
4	OUT	Output / programming interface	Output / programming interface (top die)
5	OUT	not connected	Output / programming interface (bottom die)
6	GND	not connected	Ground (bottom die)
7	V_{DD}	not connected	Supply voltage / programming interface (bottom die)
8	n/c	not connected	not connected (connection to GND is recommended)

2 General

All further specifications are regarded to both implemented sensor IC's, or otherwise noted.

2.1 Block Diagram

Figure 2-1 shows is a simplified block diagram.

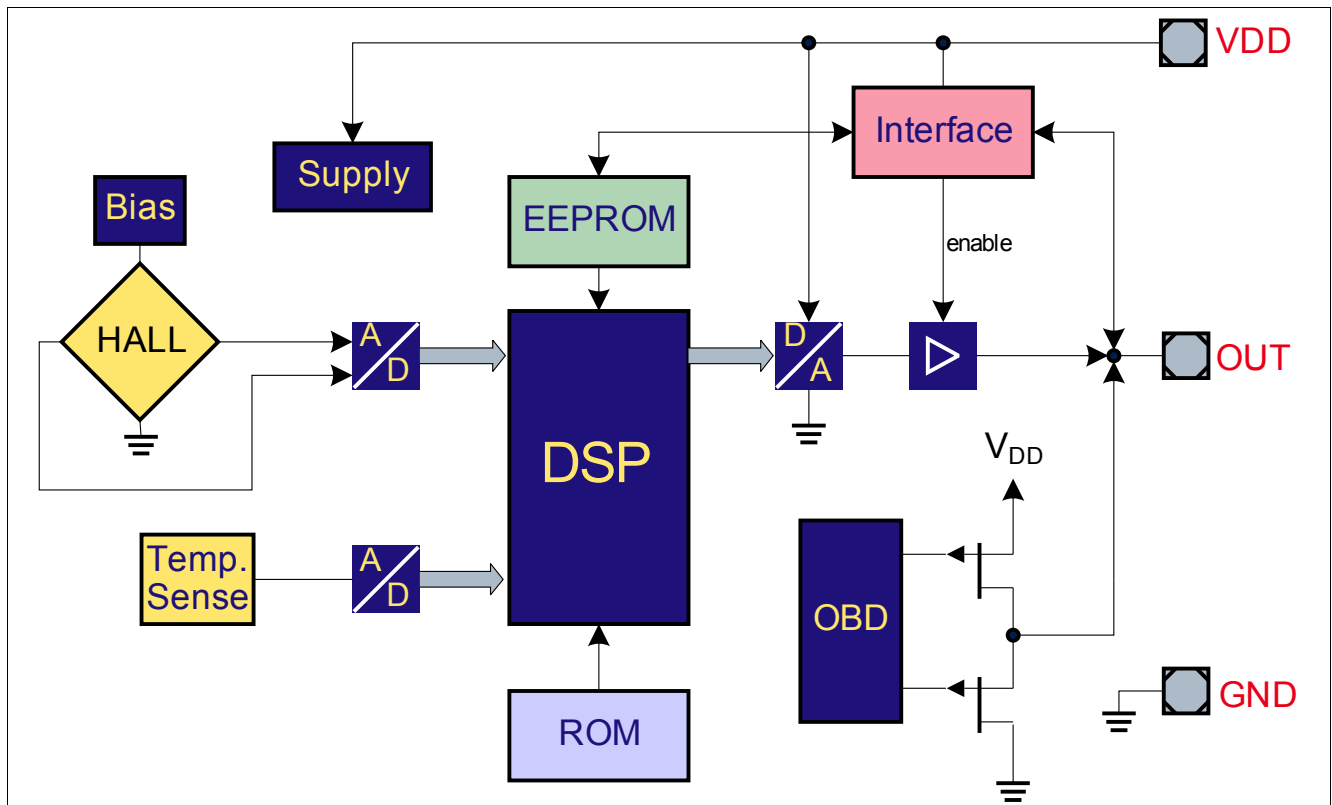

Figure 2-1 Block Diagram of the TLE4997A8(D) with the ratiometric analog output interface

2.2 Functional Description

The linear Hall IC TLE4997A8(D) has been specifically designed for highly accurate angle and position detection. The sensor provides a ratiometric analog output voltage, which is ideally suited to Analog-to-Digital (A/D) conversion with the supply voltage as a reference.

The IC is produced in BiCMOS technology with high voltage capability and also provides reverse polarity protection.

Digital signal processing using a 16-bit DSP architecture together with digital temperature and analog stress compensation guarantees excellent stability over the whole temperature range and life time.

2.3 Principle of Operation

- A magnetic flux is measured by a Hall-effect cell
- The output signal from the Hall-effect cell is converted from analog to digital signals
- The chopped Hall-effect cell and continuous-time A/D conversion ensure a very low and stable magnetic offset
- A programmable low-pass filter to reduce noise
- The temperature is measured and A/D converted
- Temperature compensation is done digitally using a second-order function
- Digital processing of the output value is based on zero field and sensitivity value
- The output value range can be clamped by digital limiters
- The final output value is D/A converted
- The output voltage is proportional to the supply voltage (ratiometric DAC)
- An On-Board-Diagnostics (OBD) circuit connects the output to V_{DD} or GND in case of errors

2.4 Transfer Functions

The examples in [Figure 2-2](#) show how different magnetic field ranges can be mapped to the desired output value ranges.

- Polarity Mode:
 - **Bipolar:** Magnetic fields can be measured in both orientations. The limit points do not necessarily have to be symmetrical around the zero field point
 - **Unipolar:** Only north- or south-oriented magnetic fields are measured
- Inversion: The gain value of either die can be set independently, to be positive or negative.

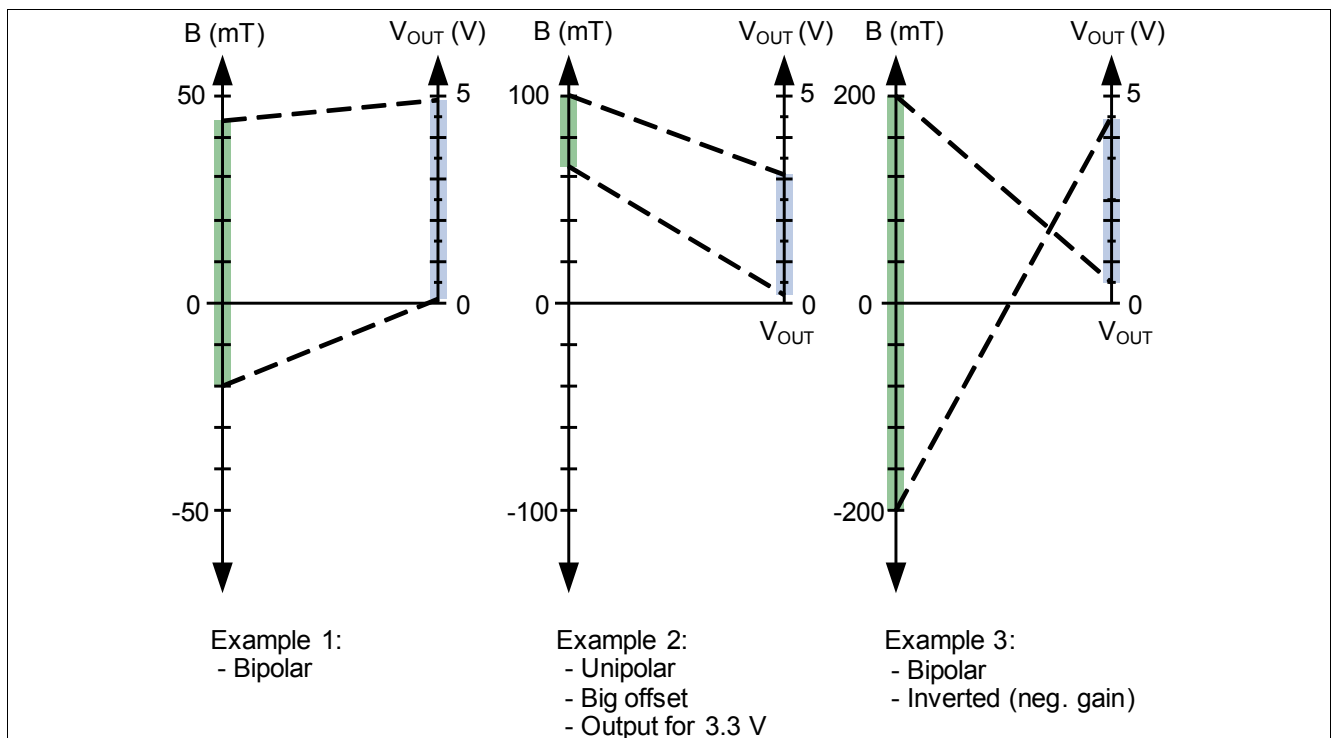

Figure 2-2 Examples of Operation

3 Maximum Ratings

Table 3-1 Absolute Maximum Ratings

Parameter	Symbol	Values			Unit	Note / Test Condition
		Min.	Typ.	Max.		
Junction temperature	T_J	- 40	–	160 ¹⁾	°C	-
Voltage on V_{DD} pin with respect to ground (V_{SS})	V_{DD}	-20 ²⁾	–	20 ³⁾	V	$R_{THja} \leq 150 \text{ K/W}$
Supply current @ overvoltage	I_{DDov}	–	–	52	mA	-
Supply current @ reverse voltage	I_{DDrev}	-75	–	–	mA	-
Voltage on output pin with respect to ground (V_{SS})	V_{OUTov}	-16 ⁴⁾	–	16 ³⁾	V	$R_{THja} \leq 150 \text{ K/W}$ V_{OUT} may be $> V_{DD}$
Magnetic field	B_{MAX}	-	–	1	T	-
ESD protection	V_{ESD}	-		± 2	kV	According HBM ANSI/ESDA/JEDEC JS-001 ⁵⁾

1) For limited time of 96 h. Depends on application temperature lifetime cycles. Please ask for support by Infineon.

2) max 24 h @ $-40^\circ\text{C} \leq T_a < 30^\circ\text{C}$
 max 10 min. @ $30^\circ\text{C} \leq T_a < 80^\circ\text{C}$
 max 30 sec. @ $80^\circ\text{C} \leq T_a < 125^\circ\text{C}$.

3) max. 24 h @ $T_J < 80^\circ\text{C}$.

4) Max. 1 ms @ $T_J < 30^\circ\text{C}$; -8.5 V for 100 h @ $T_J < 80^\circ\text{C}$.

5) 100 pF and 1.5 k Ω

Attention: Stresses above those listed under “Absolute Maximum Ratings” may cause permanent damage to the device. This is a stress rating only and functional operation of the device at these or any other conditions above those indicated in the operational sections of this specification is not implied. Furthermore, only single error cases are assumed. More than one stress/error case may also damage the device.

Exposure to absolute maximum rating conditions for extended periods may affect device reliability. During absolute maximum rating overload conditions the voltage on VDD pins with respect to ground (VSS) must not exceed the values defined by the absolute maximum ratings. Lifetime statements are an anticipation based on an extrapolation of Infineon’s qualification test results. The actual lifetime of a component depends on its form of application and type of use etc. and may deviate from such statement. The lifetime statement shall in no event extend the agreed warranty period.

4 Operating Range

The following operating conditions must not be exceeded in order to ensure correct operation of the TLE4997A8(D). All parameters specified in the following sections refer to these operating conditions, if applicable or unless otherwise indicated.

Table 4-1 Operating Range

Parameter	Symbol	Values			Unit	Note / Test Condition
		Min.	Typ.	Max.		
Supply voltage	V_{DD}	4.5	–	5.5	V	
		4	–	7	V	Extended range
Output current	I_{OUT}	-1	–	1	mA	¹⁾
Load resistance	R_L	10	–	–	k Ω	Pull-down to GND Pull-up to V_{DD}
		10	–	–		
Load capacitance	C_L	0	–	210	nF	
Ambient temperature ²⁾	T_A	- 40	–	125	$^{\circ}\text{C}$	max. 1200 h at 125 $^{\circ}\text{C}$ ³⁾

1) For V_{OUT} within the range of 5% ... 95% of V_{DD} .

2) $R_{THja} \leq 150 \text{ K/W}$.

3) Maximum exposure time at other ambient temperatures between -40 $^{\circ}\text{C}$ and 125 $^{\circ}\text{C}$ shall be calculated based on the values specified in this table using the Arrhenius model.

Note: Keeping signal levels within the limits specified in this table ensures operation without overload conditions.

5 Electrical, Thermal and Magnetic Parameters

All specification values are valid over temperature and lifetime, unless noted otherwise.

5.1 Electrical Characteristics

Table 5-1 Electrical Characteristics

Parameter	Symbol	Values			Unit	Note / Test Condition
		Min.	Typ.	Max.		
Output voltage range	V_{OUT}	5 6	–	95 94	% of V_{DD}	for $T_A \leq 120^\circ\text{C}$ for $T_A > 120^\circ\text{C}$
Supply current	I_{DD}	3	7.5	10	mA	¹⁾
Output current @ OUT shorted to supply lines	I_{OUTsh}	-30	–	30	mA	for operating supply voltage range only
Zero field voltage	V_{ZERO}	-100	–	100	%	internal offset range
Zero field voltage drift	ΔV_{ZERO}	-10	–	10	mV	In lifetime ²⁾
		-10	–	10	mV	error band over temp. ³⁾
Ratiometry error	E_{RAT}	-0.25	–	0.25	%	of V_{DD} ³⁾⁴⁾
Thermal resistance PG-TDSO-8 ⁵⁾	R_{thJA}	–	150	–	K/W	junction to air
	R_{thJC}	–	50	–		junction to case
Power-on time ⁶⁾	t_{Pon}	–	–	1	ms	$\Delta V_{OUT} \leq \pm 5\%$ of V_{DD}
		–	–	10		$\Delta V_{OUT} \leq \pm 1\%$ of V_{DD}
Power-on reset level	V_{DDpon}	2	–	4	V	
Output DAC quantization	ΔV_{OUT}		1.22		mV	@ $V_{DD} = 5\text{ V}$
Output DAC resolution	–		12		bit	
Output DAC bandwidth	f_{DAC}	–	3.2	–	kHz	interpolation filter ⁷⁾
Differential non-linearity	DNL	-1	–	1	LSB	of output DAC
Output noise (rms)	V_{noise}	–	–	3	mV	⁸⁾
Signal delay	t_{SD}	–	–	250	μs	@ 100 Hz ⁹⁾

1) Also in extended V_{DD} range. For V_{OUT} within the range of 5%... 95% of V_{DD} , $I_{OUT} = 0\text{ mA}$.

2) For Sensitivity $S \leq 25\text{ mV/mT}$. For higher sensitivities the magnetic offset drift is dominant.

3) For $4.5\text{ V} \leq V_{DD} \leq 5.5\text{ V}$ and within nominal V_{OUT} range; see “**Ratiometry**” on Page 11 for details on E_{RAT} .

4) For the maximum error in the extended voltage range, see “**Ratiometry**” on Page 11.

5) values derived from simulation with a 4 layer PCB

6) Response time to set up output data at power on when a constant field is applied. The first value given has a $\pm 5\%$ error, the second value has a $\pm 1\%$ error.

7) More information, see **Figure 7-2 “DAC Input Filter (Magnitude Plot)”** on Page 16.

8) 50 mT range (also valid for 100 mT range), LP filter setting 1320 Hz or less, gain 1.0 (scales linearly with gain)

9) A sinusoidal magnetic field is applied, V_{OUT} shows amplitude of 20% of V_{DD} , LP filter is disabled.

Ratiometry

The linear Hall sensor works like a potentiometer. The output voltage is proportional to the supply voltage. The division factor depends on the magnetic field strength. This behavior is called “ratiometric”. The supply voltage V_{DD} should be used as the reference for the A/D Converter of the micro controller. In this case, variations of V_{DD} are compensated. The ratiometry error is defined as follows:

$$E_{RAT} = \left(\frac{V_{OUT}(V_{DD})}{V_{DD}} - \frac{V_{OUT}(5V)}{5V} \right) \times 100\% \tag{5.1}$$

The ratiometry error band displays as a “Butterfly Curve”.

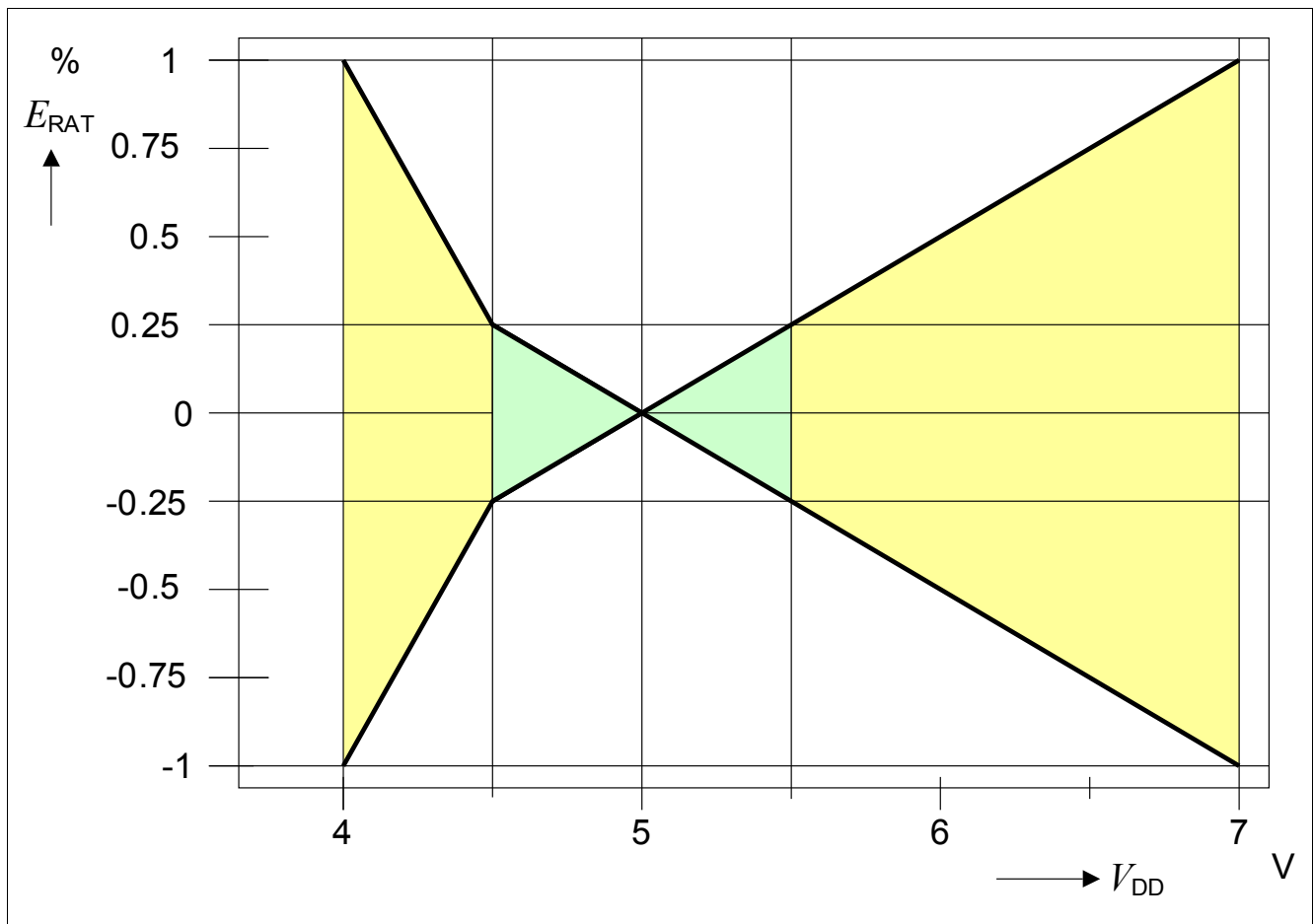

Figure 5-1 Ratiometry Error Band

Note: Take care of possible voltage drops on the V_{DD} and V_{OUT} line degrading the result. Ideally, both values are acquired and their ratio is calculated to gain the highest accuracy. This method should be used especially during calibration.

Calculation of the Junction Temperature

The internal power dissipation P_{TOT} of the sensor increases the chip junction temperature above the ambient temperature.

The power multiplied by the total thermal resistance R_{thJA} (Junction to Ambient) added to T_A leads to the final junction temperature. R_{thJA} is the sum of the addition of the two components, Junction to Case and Case to Ambient.

$$R_{thJA} = R_{thJC} + R_{thCA}$$

$$T_J = T_A + \Delta T = R_{thJA} \times P_{TOT} = R_{thJA} \times (V_{DD} \times I_{DD} + V_{OUT} \times I_{OUT}); I_{DD}, I_{OUT} > 0, \text{ if direction is into IC}$$

Example (assuming no load on V_{OUT} and TLE4997A8 type):

- $V_{DD} = 5 \text{ V}$
- $I_{DD} = 8 \text{ mA}$
- $\Delta T = 150[\text{K/W}] \times (5 [\text{V}] \times 0.008 [\text{A}] + 0 [\text{VA}]) = 6 \text{ K}$

For molded sensors, the calculation with R_{thJC} is more applicable.

5.2 Magnetic Characteristics
Table 5-2 Magnetic Characteristics

Parameter	Symbol	Values			Unit	Note / Test Condition
		Min.	Typ.	Max.		
Sensitivity	$S^{1)}$	± 12.5	–	± 300	mV/mT	programmable ²⁾
Sensitivity error band over temperature	S_E	-3		3	%	³⁾
Magnetic field range	MFR	± 50	± 100	± 200	mT	programmable ⁴⁾
Integral nonlinearity	INL	–	–	± 15	mV	$= \pm 0.3\%$ of V_{DD} ⁵⁾
Magnetic offset	B_{OS}	–	± 100	± 400	μT	⁶⁾
Magnetic offset drift	ΔB_{OS}	–	± 1	± 5	$\mu\text{T}/^\circ\text{C}$	error band ⁶⁾

1) Defined as $\Delta V_{OUT} / \Delta B$.

2) Programmable in steps of 0.024%.

3) Residual sensitivity error band over temperature when using minimum 2 temperatures. Valid in dry state only. Dry is defined after following baking process: 60minutes at $T=125^\circ\text{C}$

4) Depending on offset and gain settings, the output may already be saturated at lower fields.

5) Range $\pm 50\text{mT}$ (also valid for ranges $\pm 100 \text{ mT}$ and $\pm 200 \text{ mT}$). Gain= 1.0 (scales linearly with gain).

6) For Sensitivity $S > 25 \text{ mV} / \text{mT}$. For lower sensitivities, the zero field voltage drift is dominant.

5.3 Magnetic Field Direction Definition

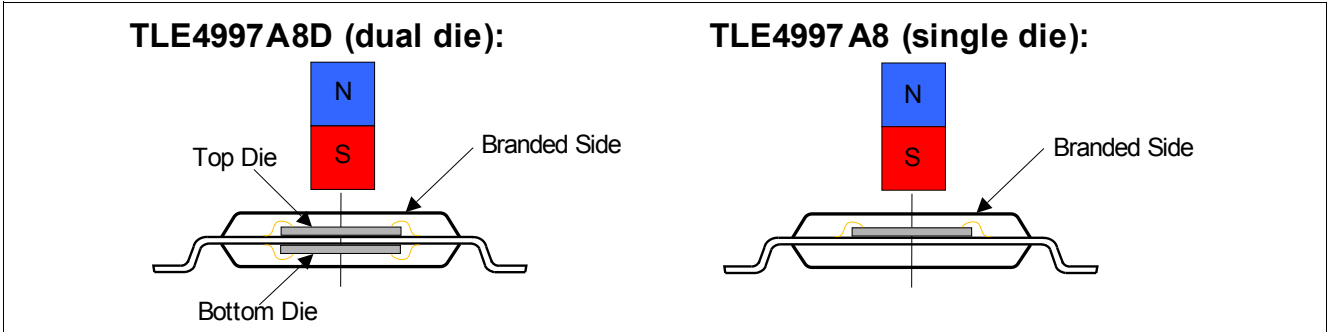

Figure 5-2 Definition of magnetic field direction of the TLE4997A8(D)

Without reconfiguration the bottom die measures the inverted field value of the top die. This leads to the characteristic shown in [Figure 5-3](#).

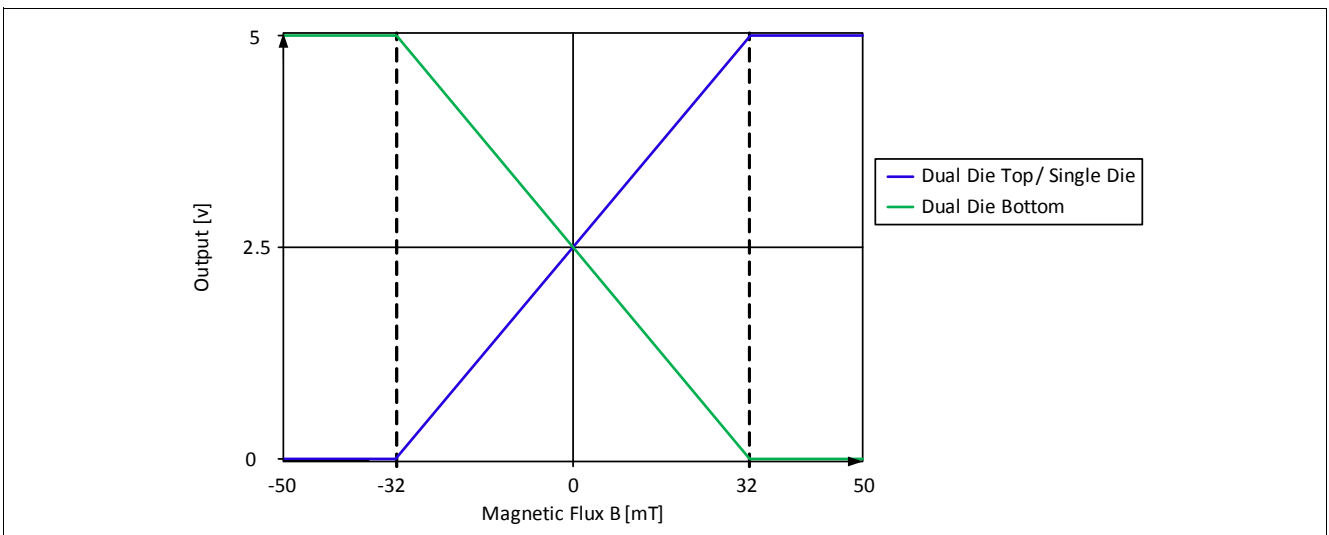

Figure 5-3 Example of the dual die output signaling

6 Application Circuit

Figure 6-1 shows the connection of two Linear Hall sensors to a micro controller.

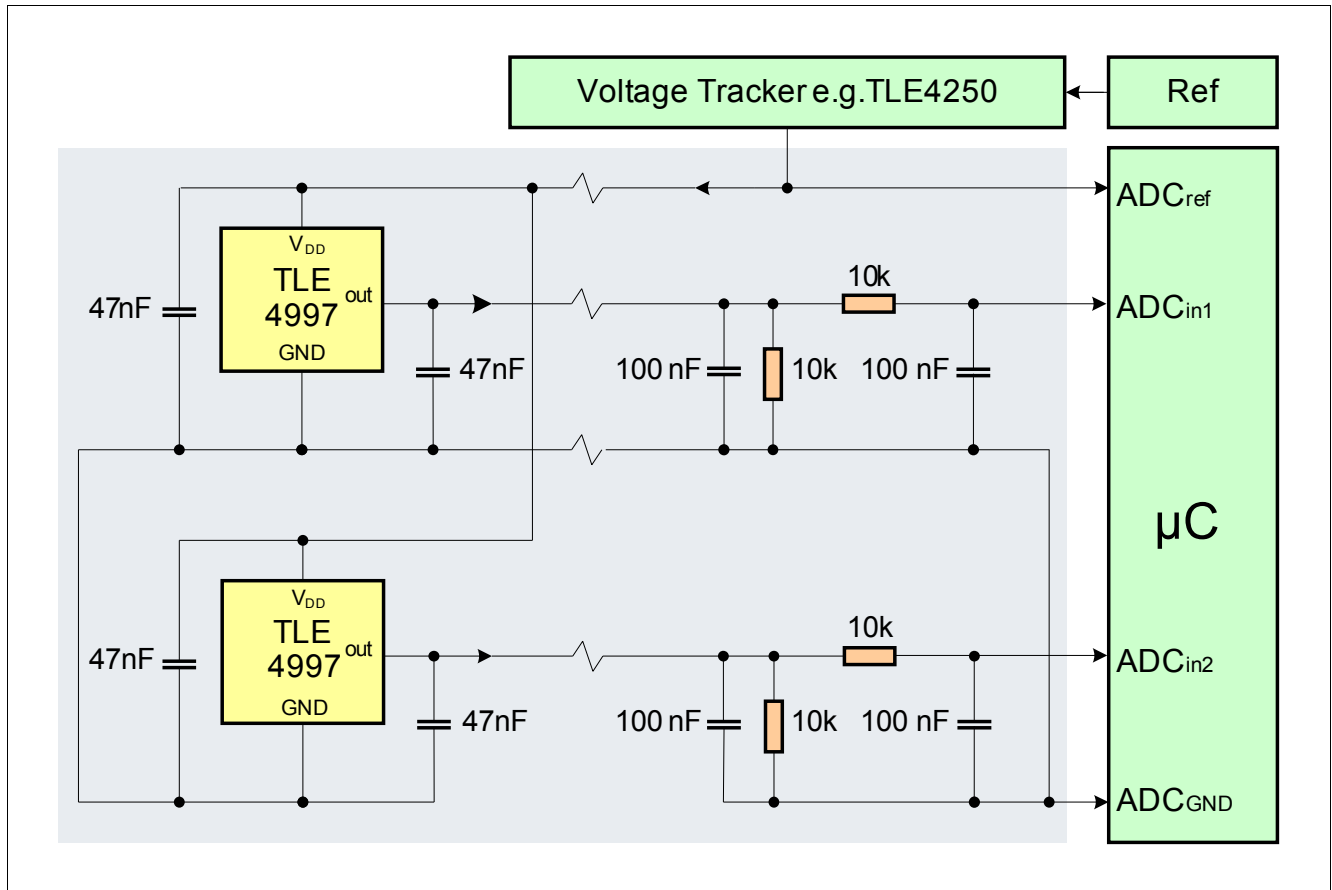

Figure 6-1 Application Circuit

Note: For calibration and programming, the interface has to be connected directly to the OUT pin.

7 Configuration and Calibration Parameters

The TLE4997A8(D) has several configurable parameters which are stored in the EEPROM. These parameters affect the internal data processing and compensation and the output protocol. This chapter gives an overview of the parameters. A detailed description of all the parameters and the programming procedure is given in the [TLE4997 User's Manual](#).

Table 7-1 TLE4997A8(D) Parameters

Parameter	Setting range	Note
Magnetic range	±50 mT ±100 mT ±200 mT	Magnetic input range of Hall ADC
Gain	-4.0....3.9998 ¹⁾²⁾	Quantization step: 244.14 ppm
Offset	-400 %V _{DD} ... 399 %V _{DD} ³⁾	Quantization step: 1.22mV@V _{DD} = 5V
Clamping low level	0 %V _{DD} ... 99.98% V _{DD}	Quantization step: 1.22mV@V _{DD} = 5V
Clamping high level	0 %V _{DD} ... 99.98% V _{DD}	Quantization step: 1.22mV@V _{DD} = 5V
Bandwidth ⁴⁾	78 Hz 244 Hz 421 Hz 615 Hz 826 Hz 1060 Hz 1320 Hz Off	Low-pass filter cut-off (-3 dB) frequency see Figure 7-1
1 st order temperature coefficient TC ₁ ⁵⁾	-1000 ppm/°C ... 3000 ppm/°C	Quantization step: 15.26 ppm/°C
2 nd order temperature coefficient TC ₂ ⁶⁾	-6 ppm/°C ² ... 6 ppm/°C ²	Quantization step: 0.119 ppm/°C ²

- 1) For gain values between -0.5 and +0.5, the numeric accuracy decreases.
- 2) Gain value of +1.0 corresponds to typical 40mV/mT sensitivity in 100 mT range. Infineon pre-calibrates the samples to 60mV/mT (100mT range).
- 3) Infineon pre-calibrates the samples at zero field to 50% of V_{DD} (100mT range)
- 4) Subject to oscillator variation ±25%
- 5) Relative range to Infineon TC₁ temperature pre-calibration, the maximum adjustable range is limited by the register-size and depends on specific pre-calibrated TL setting, full adjustable range: -2441 to +5355 ppm/°C
- 6) Relative range to Infineon TC₂ temperature pre-calibration, the maximum adjustable range is limited by the register-size and depends on specific pre-calibrated TQ setting, full adjustable range: -15 to +15 ppm/°C².

Figure 7-1 shows the filter characteristics as a magnitude plot (the highest setting is marked).

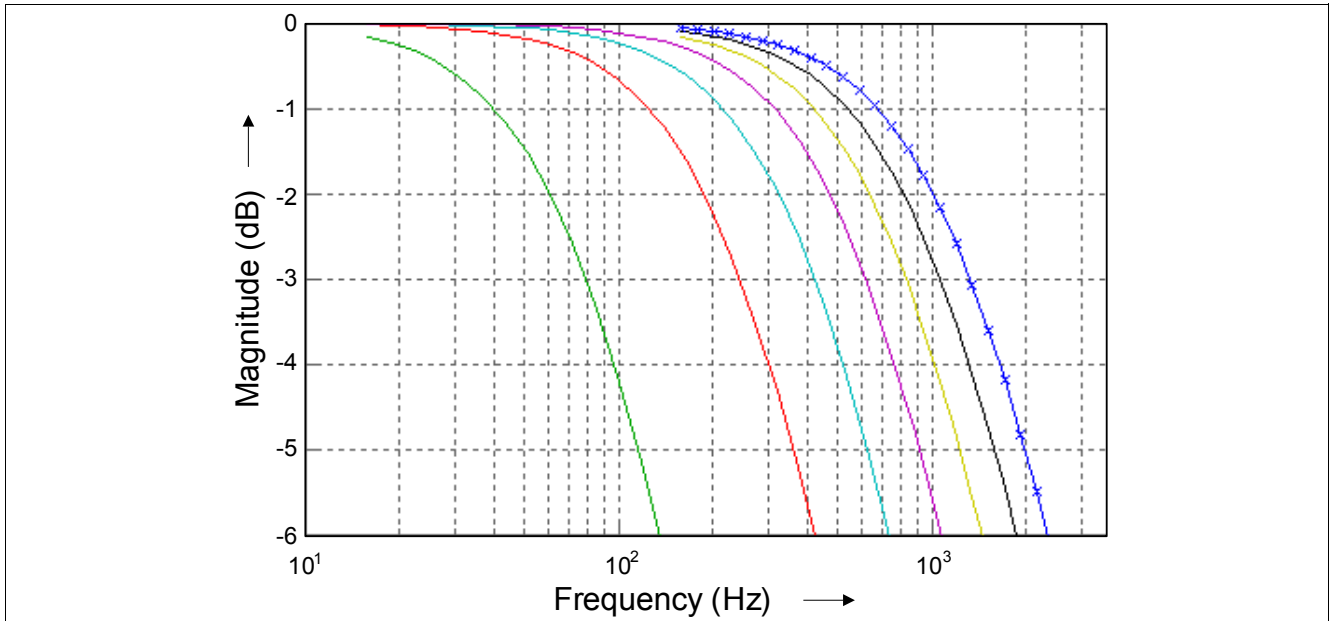

Figure 7-1 DSP Input Filter (Magnitude Plot)

An interpolation filter is placed between the DSP and the output DAC.

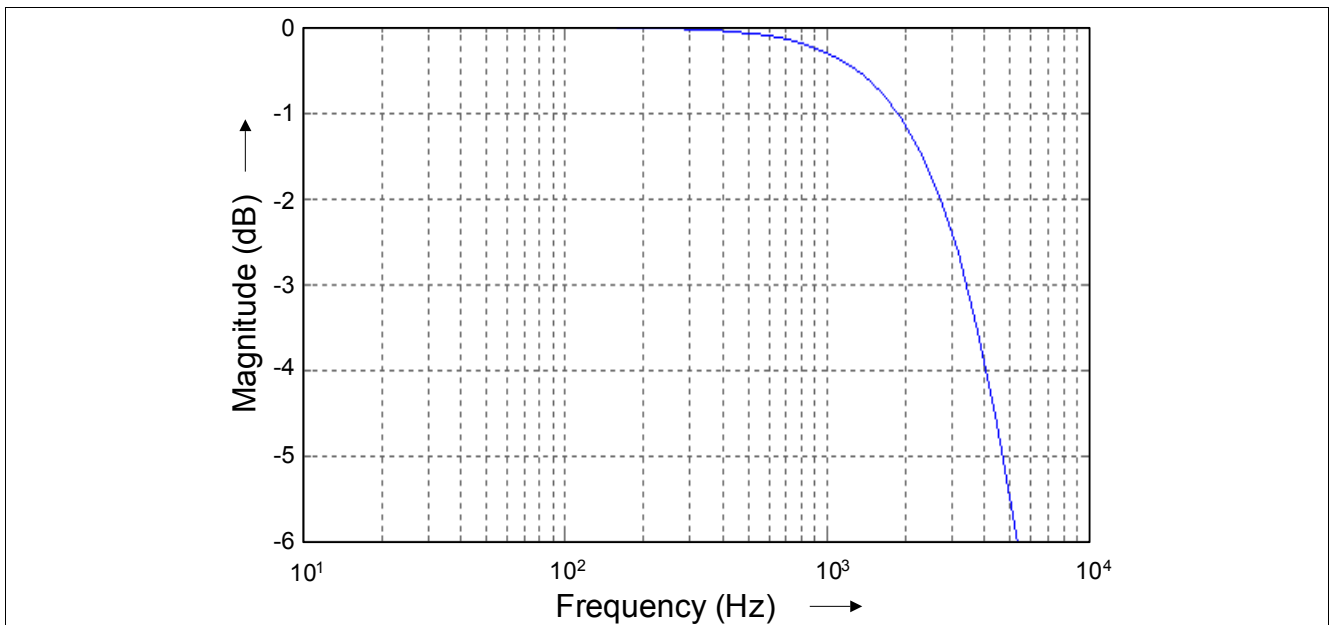

Figure 7-2 DAC Input Filter (Magnitude Plot)

Note: As this is a digital filter running with an RC-based oscillator, the cutoff frequency may vary within $\pm 25\%$.

Configuration and Calibration Parameters

Figure 7-3 shows an example in which the magnetic field range between B_{min} and B_{max} is mapped to output values between 0.8 V and 4.2 V. If it is not necessary to signal errors, the maximum output voltage range between 0.3 V and 4.7 V can be used.

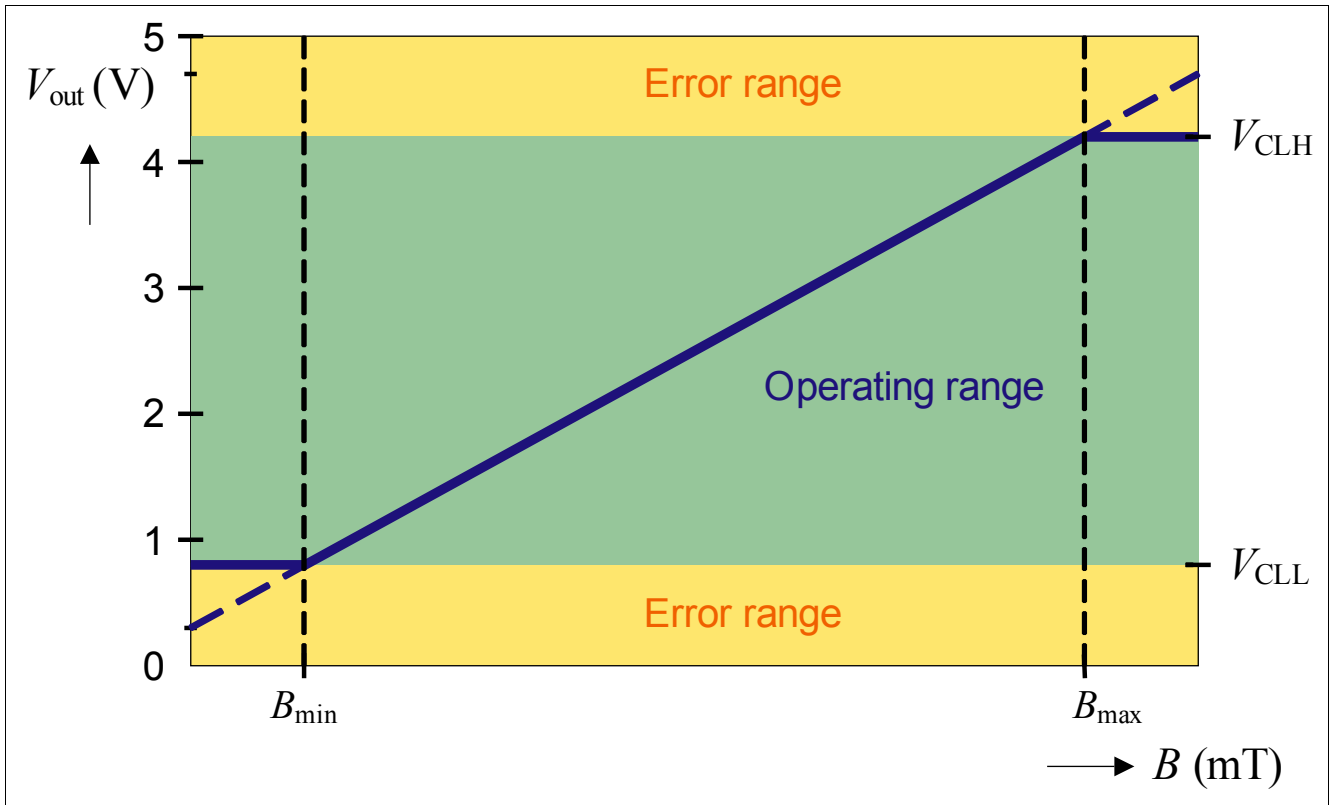

Figure 7-3 Clamping Example

Note: The clamping high value must be above the low value.

8 Error Detection

Different error cases can be detected by the On-Board-Diagnostics (OBD) and reported to the micro controller. The OBD is useful only when the clamping function is enabled. It is important to set the clamping threshold values inside the error voltage values shown in [Table 8-1](#) and [Table 8-2](#) to ensure that it is possible to distinguish between correct output voltages and error signals.

8.1 Voltages Outside the Operating Range

The output signals an error condition, if V_{DD} lies:

- Inside the ratings specified in [Table 3-1 “Absolute Maximum Ratings” on Page 8](#)
- Outside the range specified in [Table 4-1 “Operating Range” on Page 9](#)

Table 8-1 Undervoltage and Overvoltage (All values with $R_L \geq 10k$)

Parameter	Symbol	Values			Unit	Note / Test Condition
		Min.	Typ.	Max.		
Undervoltage threshold	V_{DDuv}	3	-	4	V	
Overvoltage threshold	V_{DDov}	7	-	8.3	V	
Output voltage@ undervoltage	V_{OUTuv}	$0.95 \times V_{DD}$	-	-	V	$3V \leq V_{DD} \leq V_{DDuv}$
Output voltage@ overvoltage	V_{OUTov}	$0.97 \times V_{DD}$	-	-	V	$V_{DDov} < V_{DD} \leq 16 V$
Supply current ¹⁾	I_{DDuv}	-	-	10	mA	@ undervoltage

1) For overvoltage and reverse voltage, see [Table 3-1 “Absolute Maximum Ratings” on Page 8](#).

8.2 Open Circuit of Supply Lines

In the case of interrupted supply lines, the data acquisition device can alert the user. If two sensors are placed in parallel, the output of the remaining working sensor may be still used for an emergency operation.

Table 8-2 Open Circuit (OBD Parameters)¹⁾

Parameter	Symbol	Values			Unit	Note / Test Condition
		Min.	Typ.	Max.		
Output voltage@ open V_{DD} line	V_{OUT}	0	-	0.18	V	$T_J \leq 120^\circ C$
Output voltage@ open GND line	V_{OUT}	4.82	-	5	V	$T_J \leq 120^\circ C$

1) With $V_{DD} = 5 V$ and $R_L \geq 10 k\Omega$ pull-down or $R_L \geq 20 k\Omega$ pull-up.

8.3 Not Correctable EEPROM Errors

The parity method is able to correct one single bit in one EEPROM line. One other single bit error in another line can also be detected. As this situation is not correctable, this status is represented at the output pin by clamping the output value to V_{DD} .

Table 8-3 EEPROM Error Signalling

Parameter	Symbol	Values			Unit	Note / Test Condition
		Min.	Typ.	Max.		
Output voltage @ EEPROM error	V_{OUT}	$0.97 \times V_{DD}$	-	V_{DD}	V	

9 PG-TDSO-8 Package Outlines

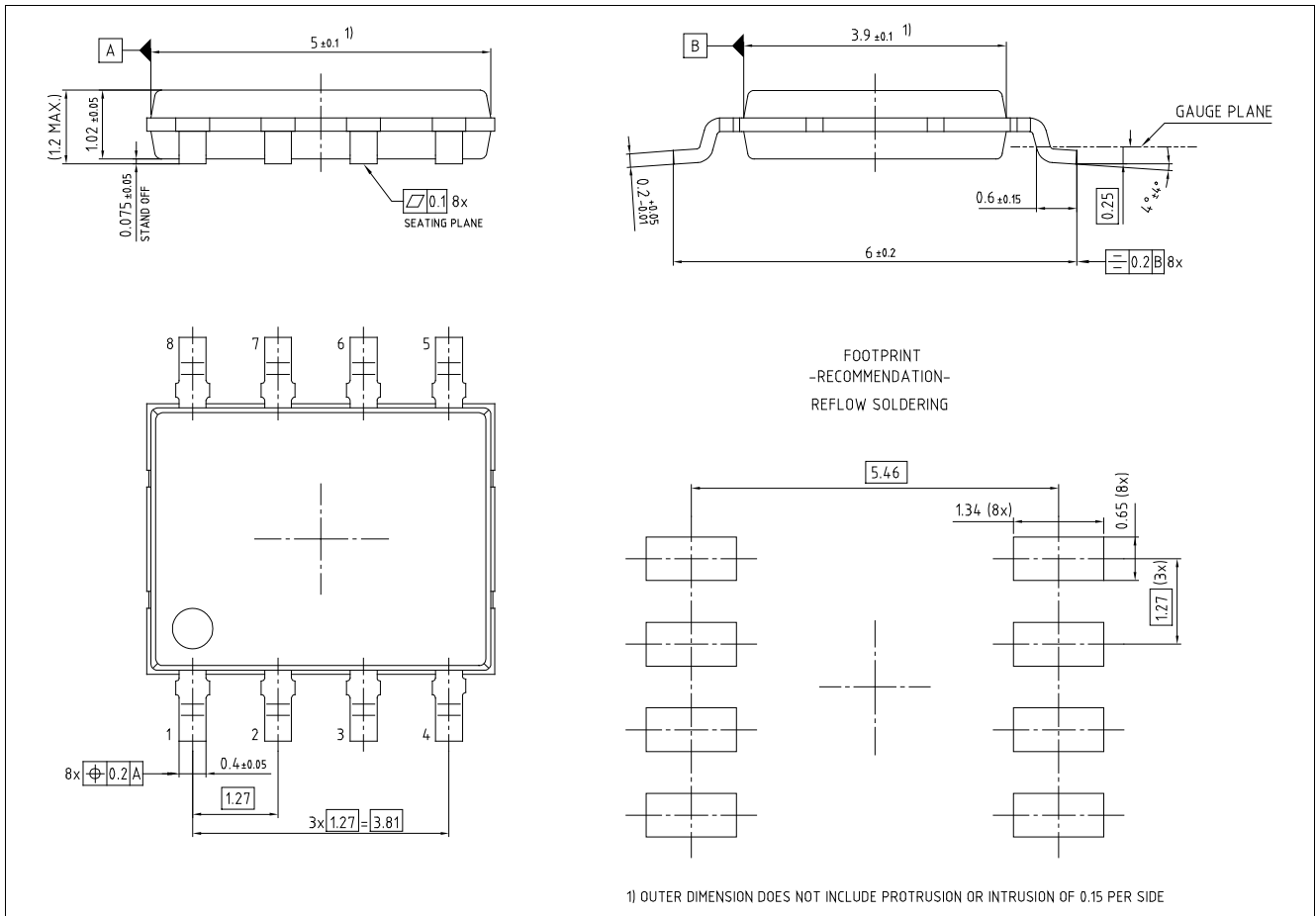

Figure 9-1 PG-TDSO-8 (PG-TDSO-Plastic Green Thin Dual Small Outline), Package Dimensions

9.1 Distance Chip to package

Figure 9-2 shows the distance of the chip surface to the PG-TDSO-8 surface.

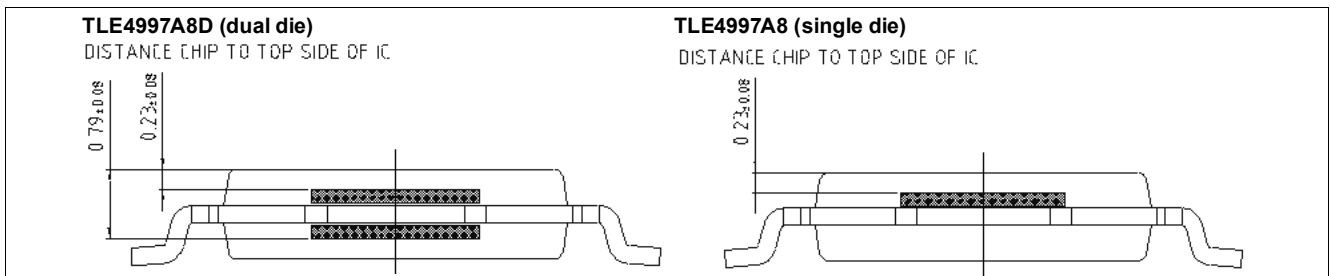

Figure 9-2 Distance of chip surface to package surface

9.2 Moisture Sensitivity Level (MSL)

The PG-TDSO-8 fulfills the MSL level 3 according to IPC/JEDEC J-STD-033B.1.

10 PG-TDSO-8 Package Marking

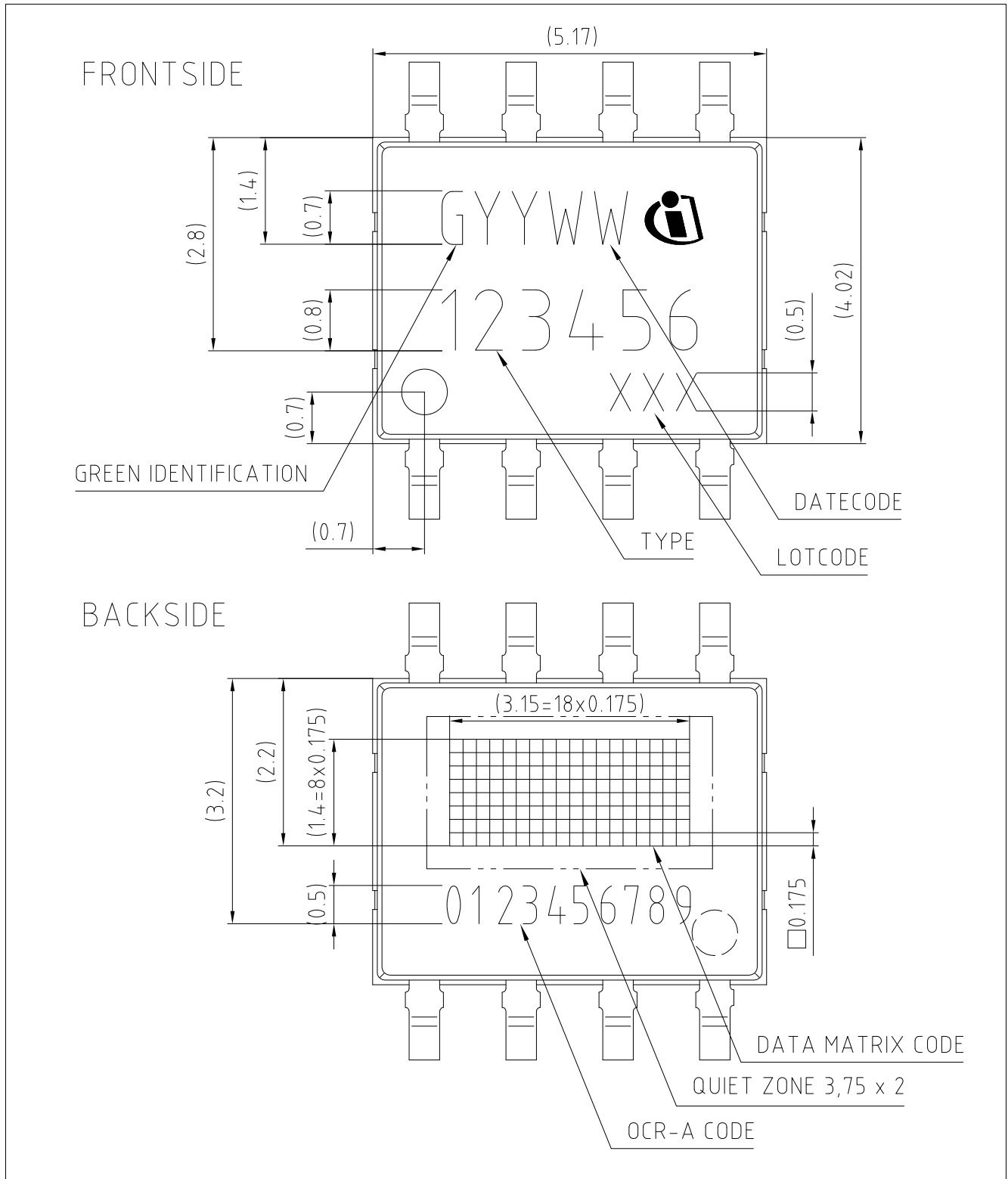

Figure 10-1 PG-TDSO-8 (PG-TDSO-Plastic Green Thin Dual Small Outline), Package Marking

Revision History

Page or Item	Subjects (major changes since previous revision)
Revision 1.1, 2018-01	
Page 4	Removed AEC Q100 revision version

Trademarks of Infineon Technologies AG

AURIX™, C166™, CanPAK™, CIPOS™, CIPURSE™, EconoPACK™, CoolMOS™, CoolSET™, CORECONTROL™, CROSSAVE™, DAVE™, EasyPIM™, EconoBRIDGE™, EconoDUAL™, EconoPIM™, EiceDRIVER™, eupec™, FCOS™, HITFET™, HybridPACK™, I²RF™, ISOFACE™, IsoPACK™, MIPAQ™, ModSTACK™, my-d™, NovalithIC™, OptiMOS™, ORIGA™, PRIMARION™, PrimePACK™, PrimeSTACK™, PRO-SIL™, PROFET™, RASIC™, ReverSave™, SatRIC™, SIEGET™, SINDRION™, SIPMOS™, SmartLEWIS™, SOLID FLASH™, TEMPFET™, thinQ!™, TRENCHSTOP™, TriCore™.

Other Trademarks

Advance Design System™ (ADS) of Agilent Technologies, AMBA™, ARM™, MULTI-ICE™, KEIL™, PRIMECELL™, REALVIEW™, THUMB™, μVision™ of ARM Limited, UK. AUTOSAR™ is licensed by AUTOSAR development partnership. Bluetooth™ of Bluetooth SIG Inc. CAT-ig™ of DECT Forum. COLOSSUS™, FirstGPS™ of Trimble Navigation Ltd. EMV™ of EMVCo, LLC (Visa Holdings Inc.). EPCOS™ of Epcos AG. FLEXGO™ of Microsoft Corporation. FlexRay™ is licensed by FlexRay Consortium. HYPERTERMINAL™ of Hilgraeve Incorporated. IEC™ of Commission Electrotechnique Internationale. IrDA™ of Infrared Data Association Corporation. ISO™ of INTERNATIONAL ORGANIZATION FOR STANDARDIZATION. MATLAB™ of MathWorks, Inc. MAXIM™ of Maxim Integrated Products, Inc. MICROTEC™, NUCLEUS™ of Mentor Graphics Corporation. Mifare™ of NXP. MIPI™ of MIPI Alliance, Inc. MIPS™ of MIPS Technologies, Inc., USA. muRata™ of MURATA MANUFACTURING CO., MICROWAVE OFFICE™ (MWO) of Applied Wave Research Inc., OmniVision™ of OmniVision Technologies, Inc. Openwave™ Openwave Systems Inc. RED HAT™ Red Hat, Inc. RFMD™ RF Micro Devices, Inc. SIRIUS™ of Sirius Satellite Radio Inc. SOLARIS™ of Sun Microsystems, Inc. SPANSION™ of Spansion LLC Ltd. Symbian™ of Symbian Software Limited. TAIYO YUDEN™ of Taiyo Yuden Co. TEAKLITE™ of CEVA, Inc. TEKTRONIX™ of Tektronix Inc. TOKO™ of TOKO KABUSHIKI KAISHA TA. UNIX™ of X/Open Company Limited. VERILOG™, PALLADIUM™ of Cadence Design Systems, Inc. VLYNQ™ of Texas Instruments Incorporated. VXWORKS™, WIND RIVER™ of WIND RIVER SYSTEMS, INC. ZETEX™ of Diodes Zetex Limited.

Last Trademarks Update 2011-02-24

www.infineon.com

Published by Infineon Technologies AG