

High Voltage ICs

HIGH SIDE DRIVER IC

AUIRS2123S/AUIRS2124S

Features

- Floating channel designed for bootstrap operation
- Fully operational to +600 V
- Tolerant to negative transient voltage – dV/dt immune
- Gate drive supply range from 10 V to 20 V
- Undervoltage lockout
- CMOS Schmitt-triggered inputs with pull-down (AUIRS2123S)
- CMOS Schmitt-triggered inputs with pull-up (AUIRS2124S)
- Output in phase with input (AUIRS2123S) or out of Phase with input (AUIRS2124S)
- RESET- input is 3.3V and 5V logic compatible (AUIRS2123S only)
- Leadfree, RoHS compliant
- Automotive qualified

Typical Applications

- General purpose single high side driver
- Automotive injection
- Automotive inverters
- Automotive SMPS

Product Summary

Topology	Single high side
V_{OFFSET}	$\leq 600 \text{ V}$
V_{OUT}	10 V – 20 V
$I_{\text{O+}} \& I_{\text{O-}}$ (typical)	500 mA
$t_{\text{ON}} \& t_{\text{OFF}}$ (typical)	140 ns & 140 ns

Package Options

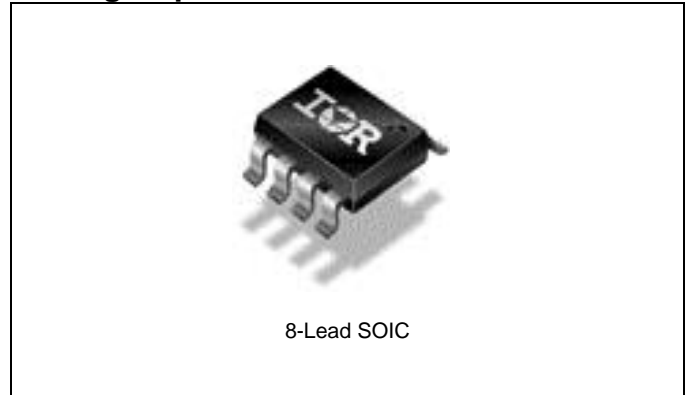

Typical Connection Diagram

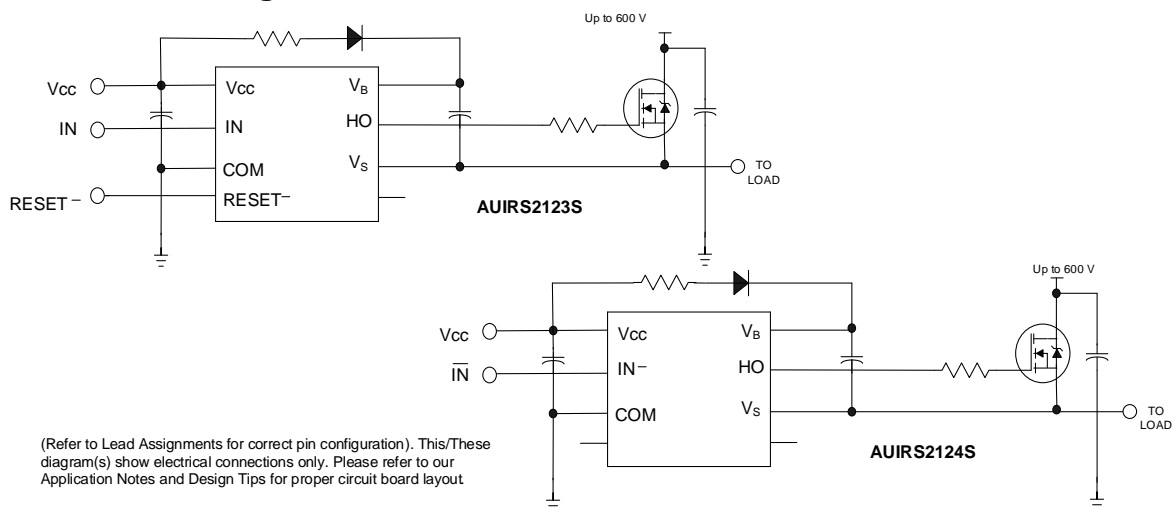

Ordering Information

Base Part Number	Package Type	Standard Pack		Complete Part Number
		Form	Quantity	
AUIRS2123S	SOIC8	Tape and Reel	2500	AUIRS2123STR
AUIRS2124S	SOIC8	Tape and Reel	2500	AUIRS2124STR

Table of Contents	Page
Description	3
Qualification Information	4
Absolute Maximum Ratings	4
Recommended Operating Conditions	5
Static Electrical Characteristics	6
Dynamic Electrical Characteristics	7
Functional Block Diagram	8
Input/Output Pin Equivalent Circuit Diagram	9
Lead Definitions	10
Lead Assignments	10
Application Information and Additional Details	11
Parameter Temperature Trends	12
Package Details	16
Tape and Reel Details	17
Part Marking Information	18
Publisher notes	

Description

The AUIRS2123S/AUIRS2124S are high voltage, high speed power MOSFET and IGBT drivers. Proprietary HVIC and latch immune CMOS technologies enable ruggedized monolithic construction. The RESET- input is compatible with standard CMOS outputs (AUIRS2123S only). The output drivers feature a high pulse current buffer stage designed for minimum cross-conduction. The floating channel can be used to drive an N-channel power MOSFET or IGBT in the high-side configuration which operates up to 600 V.

Qualification Information

Qualification Level		Automotive (per AEC-Q100)	
		Comments: This family of ICs has passed an Automotive qualification. IR's Industrial and Consumer qualification level is granted by extension of the higher Automotive level.	
Moisture Sensitivity Level		SOIC8	MSL3 - 260°C (per IPC/JEDEC J-STD-020)
ESD	Machine Model	Class M3 (per AEC-Q100-003)	
	Human Body Model	Class H1C (per AEC-Q100-002)	
	Charged Device Model	Class C5 (per AEC-Q100-011)	
IC Latch-Up Test		Class II, Level A (per AEC-Q100-004)	
RoHS Compliant		Yes	

Absolute Maximum Ratings

Absolute Maximum Ratings indicate sustained limits beyond which damage to the device may occur. All voltage parameters are absolute voltages referenced to GND, all currents are defined positive into any lead. This is a stress only rating and operation of the device at these or any conditions exceeding those indicated in the operational sections of this specification is not implied

Symbol	Definition	Min.	Max.	Units
V_{BS}	High Side Floating Supply Voltage	-0.3	25	V
V_B	High Side Driver Output Stage Voltage	-0.3	625	V
V_S	High Side Floating Supply Offset Voltage	$V_B - 25$	$V_B + 0.3$	V
V_{Ho}	Output Voltage Gate Connection	$V_S - 0.3$	$V_B + 0.3$	V
V_{CC}	Supply Voltage	-0.3	25	V
V_{IN}	Input Voltage	-0.3	$V_{CC} + 0.3$	V
V_{RES}	Reset Input Voltage	-0.3	$V_{CC} + 0.3$	V
dV/dt	Allowable Offset Voltage Slew Rate	-50	50	V/nsec
T_J	Junction Temperature	-55	150	°C
T_S	Storage Temperature	-55	150	

Recommended Operating Conditions

For proper operations the device should be used within the recommended conditions.

Symbol	Definition	Min.	Max.	Units
V_B	High Side Driver Output Stage Voltage -10V Transient 0.4 us	$V_S + 10$	$V_S + 20$	V
V_S	High Side Floating Supply Offset Voltage -25V Transient 0.4 μ s	†	600	V
V_{Ho}	Output Voltage Gate Connection	V_S	V_B	V
V_{CC}	Supply Voltage	10	20	V
V_{IN}	Input Voltage	0	V_{CC}	V
V_{RES}	Reset Input Voltage	0	V_{CC}	V
T_A	Ambient Temperature ($f_s < 60\text{kHz}$, $V_{BS} = 14\text{V}$, $C_{load} = 2.5\text{nF}$, $R = 50\text{Ohm}$)	-40	125	°C

† Logic operational for V_S of -5 to +600 V. Logic state held for V_S of -5 V to $-V_{BS}$.
(Please refer to the Design Tip DT97-3 for more details).

Static Electrical Characteristics

V_{BIAS} (V_{CC} , V_{BS}) = 15 V and T_A = 25°C unless otherwise specified. The V_{IL} , V_{IH} and I_{IN} parameters are referenced to COM. The V_O and I_O parameters are referenced to COM and are applicable to the respective output leads: HO and LO.

Symbol	Definition		Min	Typ	Max	Units	Test Conditions		
V_{IHIN}	IN Logic "1" input voltage	AUIRS2123S	0.70	—	—	V			
	IN Logic "0" input voltage	AUIRS2124S	* V_{CC}	—	—				
V_{ILIN}	IN Logic "0" input voltage	AUIRS2123S	—	—	0.35				
	IN Logic "1" input voltage	AUIRS2124S	—	—	* V_{CC}				
V_{IHRST}	RESET- Logic "1" input voltage	AUIRS2123S	—	—	1.5				
V_{ILRST}	RESET- Logic "0" input voltage	AUIRS2123S	2.9	—	—				
V_{OH}	High level output voltage, $V_{BIAS} - V_O$		—	—	2			$I_O = 10\text{ mA}$	
V_{OL}	Low level output voltage, V_O		—	0.1	0.2				
I_{LK}	Offset supply leakage current		—	—	50			μA	$V_B = V_S = 600\text{ V}$
I_{QBS}	Quiescent V_{BS} supply current		—	—	240				$V_{IN} = 0\text{ V}$ or V_{CC}
I_{QCC}	Quiescent V_{CC} supply current		—	—	500	$V_{reset} = 5\text{ V}$			
I_{IN+}	$V_{IN} = 5\text{ V}$ Pull Down Input Current	AUIRS2123S	—	125	—	$V_{IN} = 5\text{ V}$			
	$V_{IN} = 0\text{ V}$ IN Pull Up Input Current	AUIRS2124S				$V_{IN} = 0\text{ V}$			
I_{IN-}	$V_{IN} = 0\text{ V}$ IN Pull Down Input Current	AUIRS2123S	—	—	5.0	$V_{IN} = 15\text{ V}$			
	$V_{IN} = 15\text{ V}$ Pull Up Input Current	AUIRS2124S							
I_{RES-}	$V_{RESET} = 5\text{ V}$ Pull Down Input Current	AUIRS2123S	—	125	—	$V_{RESET} = 5\text{ V}$			
I_{RES+}	$V_{RESET} = 0\text{ V}$ Pull Down Input Current	AUIRS2123S	—	—	5.0	$V_{RESET} = 0\text{ V}$			
V_{BSUV+}	V_{BS} supply undervoltage positive going threshold		7.2						
V_{BSUV-}	V_{BS} supply undervoltage negative going threshold		6.6	8.0	9.0				
V_{CCUV+}	V_{CC} supply undervoltage positive going threshold		7.2	8.6	9.6				
V_{CCUV-}	V_{CC} supply undervoltage negative going threshold		6.6	8.0	9.0				
I_{O+}	Output high short circuit pulsed current (†)		250	500	—	mA	$V_O = 0\text{ V}$, $V_{IN} = \text{Logic "1"}$ $PW \leq 10\ \mu\text{s}$		
I_{O-}	Output low short circuit pulsed current(†)		250	500	—		$V_O = 15\text{ V}$, $V_{IN} = \text{Logic "0"}$ $PW \leq 10\ \mu\text{s}$		

(†) : guaranteed by design.

Dynamic Electrical Characteristics

V_{BIAS} (V_{CC} , V_{BS}) = 15 V, C_L = 1000 pF, T_A = 25°C unless otherwise specified. The dynamic electrical characteristics are measured using the test circuit shown in Fig. 3.

Symbol	Definition	Min	Typ	Max	Units	Test Conditions
t_{on}	Turn-on propagation delay	—	140	240	ns	$V_S = 0$ V and $V_S = 600$ V
t_{off}	Turn-off propagation delay	—	140	240		
t_r	Turn-on rise time	—	80	200		
t_f	Turn-off fall time	—	80	200		
t_{RES}	RESET to output turn off propagation delay (AUIRS2123S only)	—	170	300		

I/O Pin Equivalent Circuit Diagram

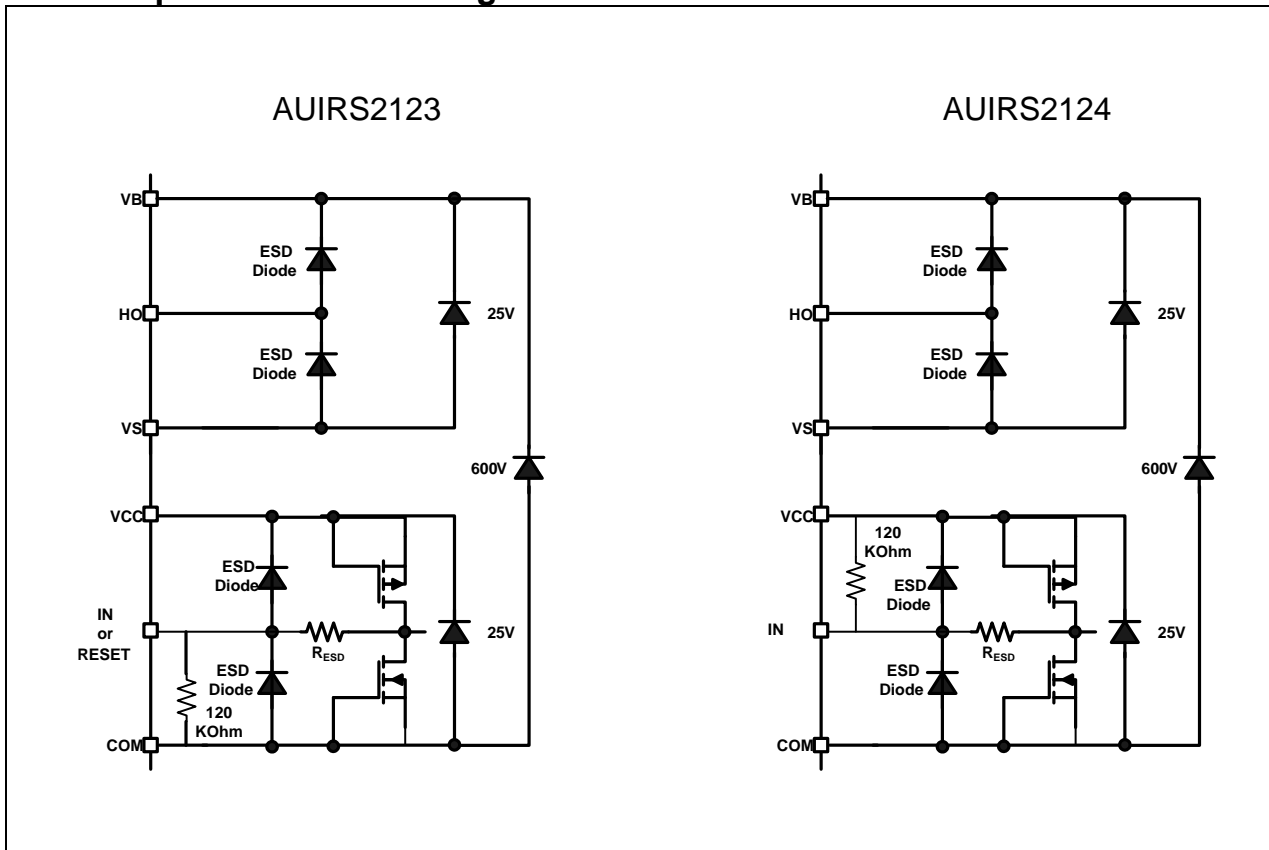

Lead Definitions

Pin	Symbol	Pin description
1	V _{CC}	Low side and logic fixed supply
2	IN IN-	Logic input for gate driver output (HO), in phase with HO (AUIRS2123S) Logic input for gate driver output (HO), out of phase with HO (AUIRS2124S)
3	COM	Logic Ground
4	RESET- NC	Driver Enable Signal Input (negative logic) (AUIRS2123S) No connection (AUIRS2124S)
5	NC	No connection
6	V _S	High-side floating supply return
7	H _O	High-side gate drive output
8	V _B	High-side floating supply

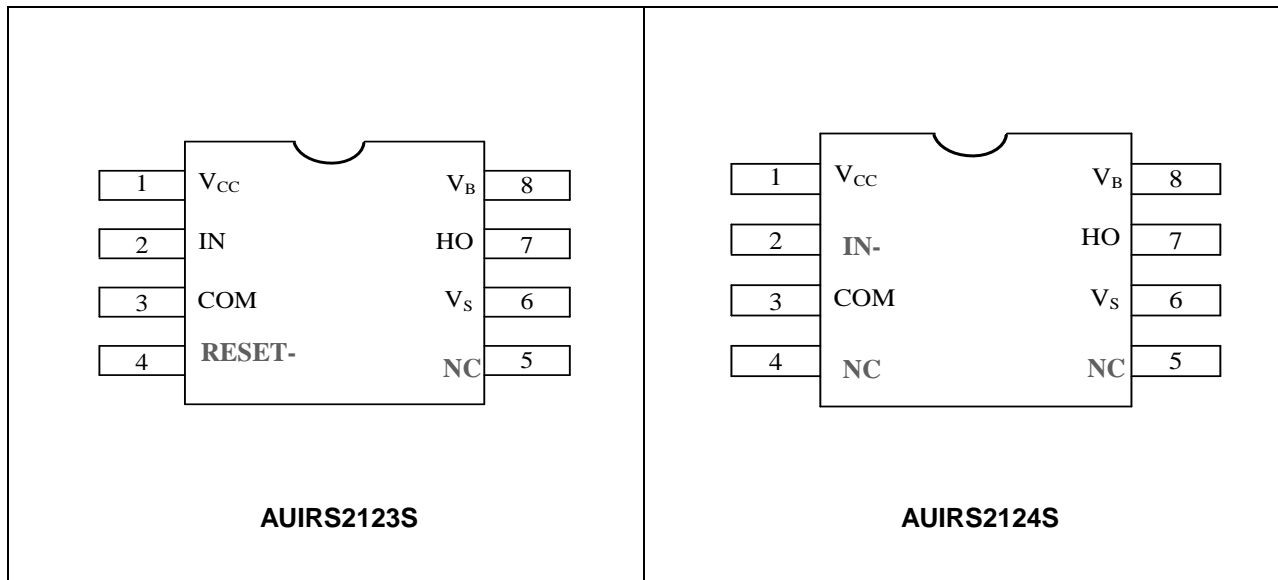

Application Information and Additional Details

AUIRS2123S logic table for V_{CC} , V_{BS} , RESET, IN, and H_o

V_{CC}	V_{BS}	RESET-	IN	H_o
X	X	X	LOW	OFF
X	X	LOW	X	OFF
< $V_{CCUVLO-}$	X	X	X	OFF
X	< $V_{BSUVLO-}$	X	X	OFF
> $V_{CCUVLO+}$	> $V_{BSUVLO+}$	HIGH	HIGH	ON

RESET = HIGH indicates that high side NMOS is allowed to be turned on.

RESET = LOW indicates that high side NMOS is OFF.

IN = HIGH indicates that high side NMOS is on.

IN = LOW indicates that high side NMOS is off.

X = independent

AUIRS2124S logic table for V_{CC} , V_{BS} , RESET, IN, and H_o

V_{CC}	V_{BS}	IN-	H_o
X	X	HIGH	OFF
< $V_{CCUVLO-}$	X	X	OFF
X	< $V_{BSUVLO-}$	X	OFF
> $V_{CCUVLO+}$	> $V_{BSUVLO+}$	LOW	ON

IN- = HIGH indicates that high side NMOS is on.

IN- = LOW indicates that high side NMOS is off.

X = independent

Parameter Temperature Trends

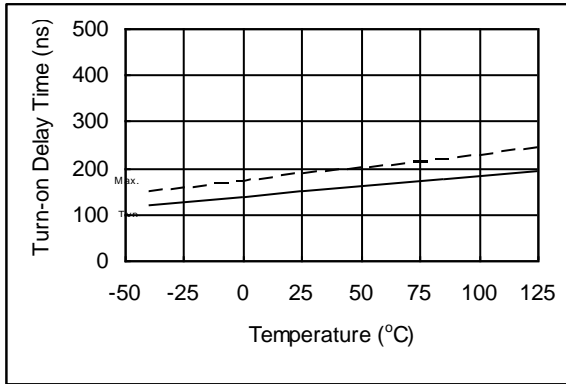

Figure 1A. Turn-on Delay Time vs. Temperature

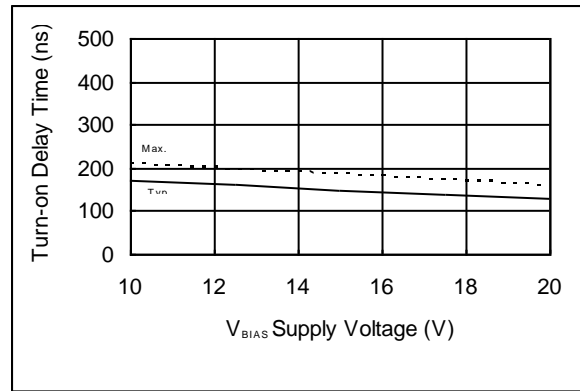

Figure 1B. Turn-on Delay Time vs. Supply Voltage

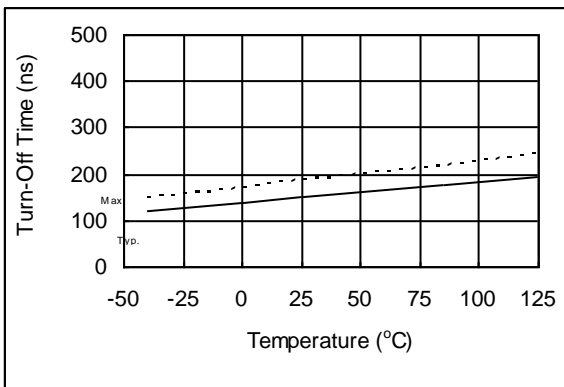

Figure 2A. Turn-Off Time vs. Temperature

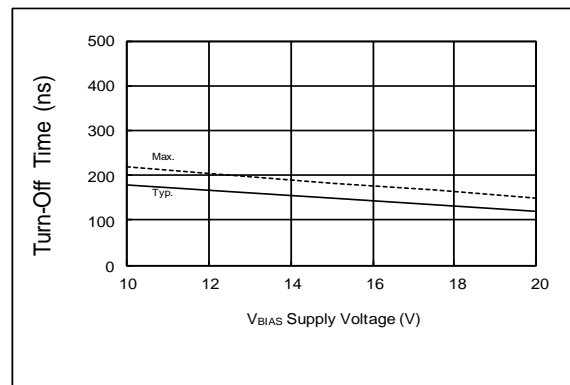

Figure 2B. Turn-Off Time vs. Supply Voltage

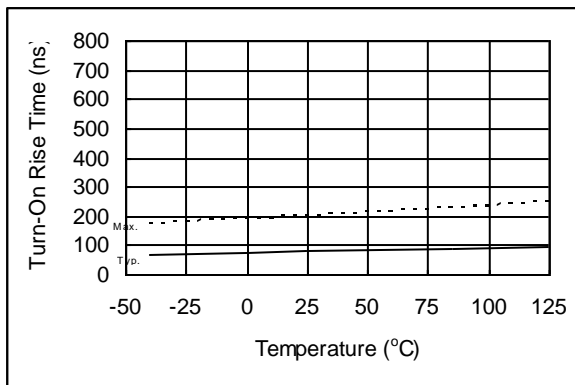

Figure 3A. Turn-On Rise Time (VBS=17V) vs. Temperature

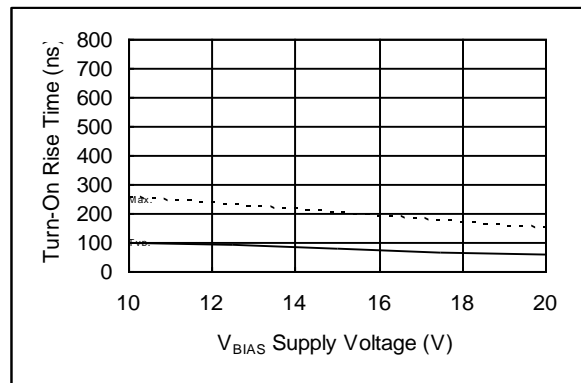

Figure 3B. Turn-On Rise Time (VBS=17V) vs. Supply Voltage

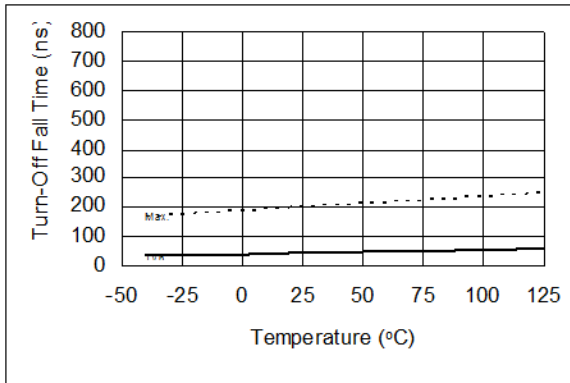

Figure 4A. Turn-Off Fall Time (VBS=17V) vs. Temperature

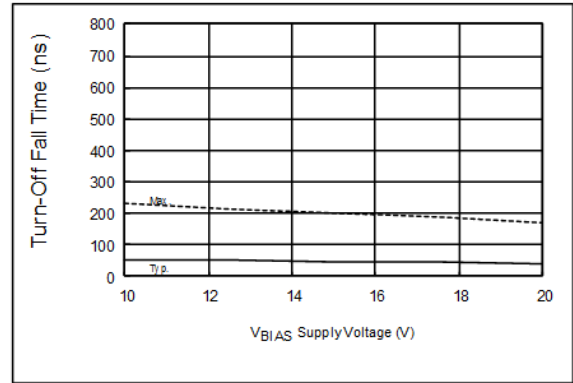

Figure 4B. Turn-Off Fall Time (VBS=17) vs. Supply Voltage

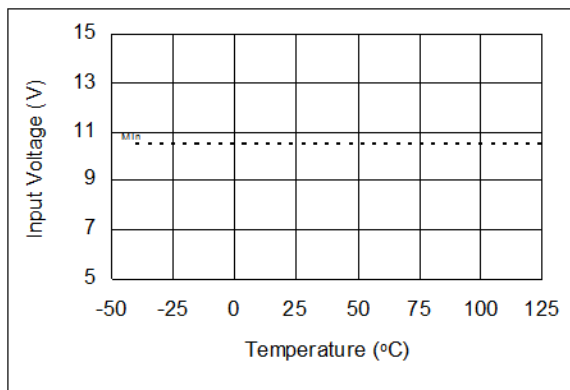

Figure 5A. Logic "1" Input Voltage vs. Temperature

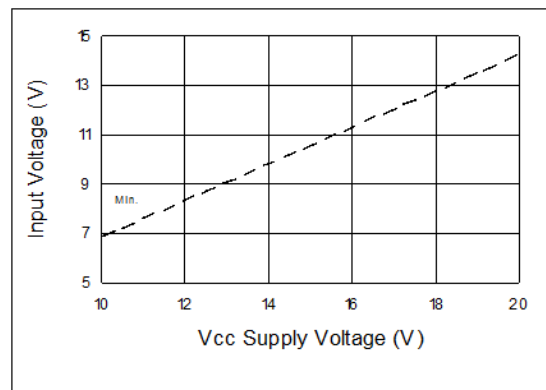

Figure 5B. Logic "1" Input Voltage vs. Supply Voltage

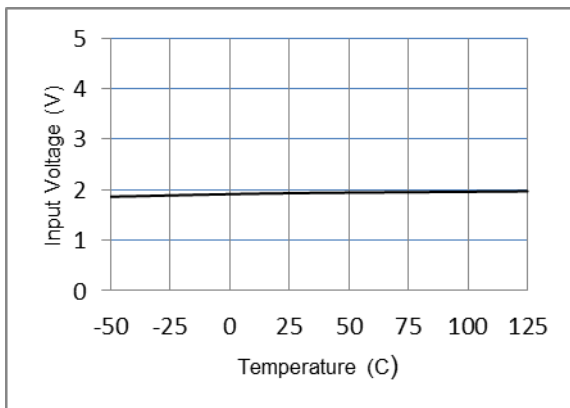

Figure 5C. Logic "1" Input Voltage (RESET pin) versus Temperature

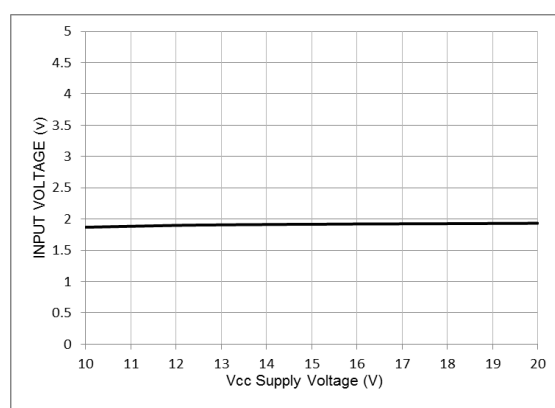

Figure 5D. Logic "1" Input Voltage (RESET pin) versus Supply Voltage

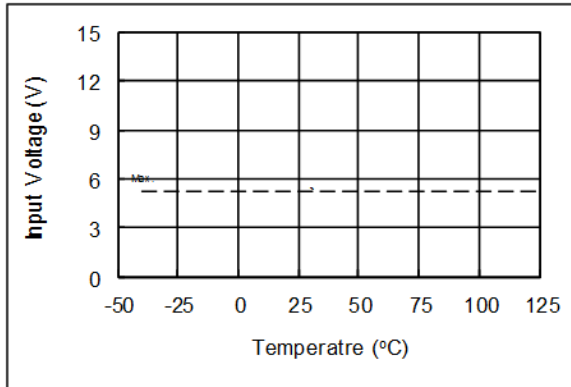

Figure 6A. Logic "0" Input Voltage vs. Temperature

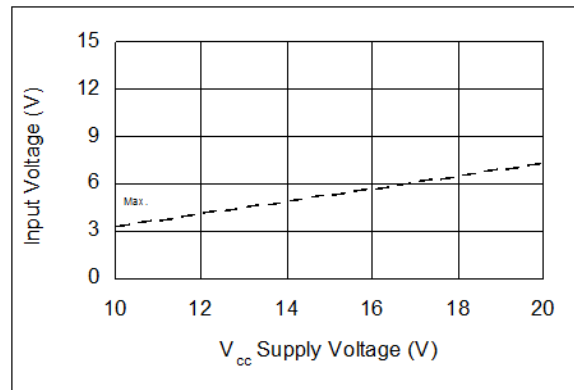

Figure 6B. Logic "0" Input Voltage vs. Supply Voltage

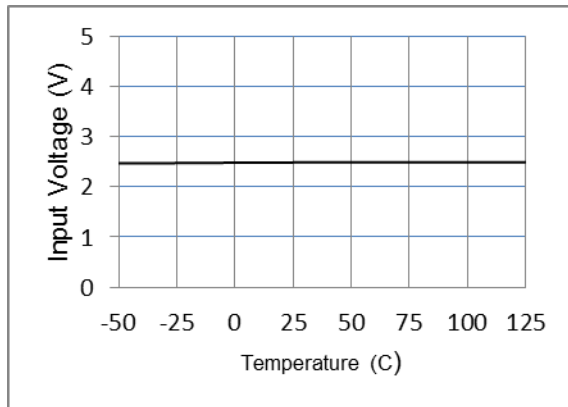

Figure 6C. Logic "0" Input Voltage (RESET pin) versus Temperature

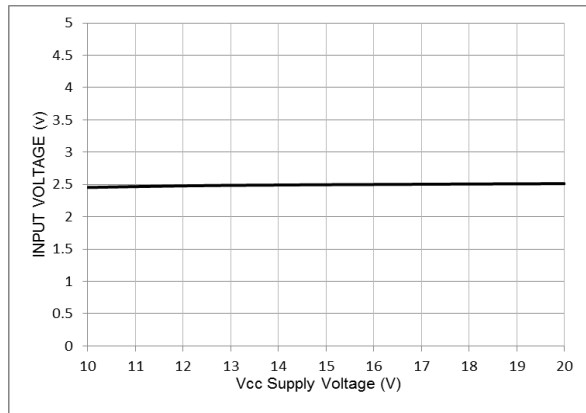

Figure 6D. Logic "0" Input Voltage (RESET pin) versus Supply Voltage

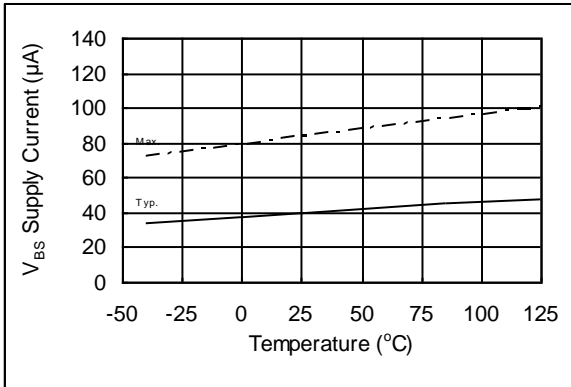

Figure 7A. VBS Supply Current vs. Temperature

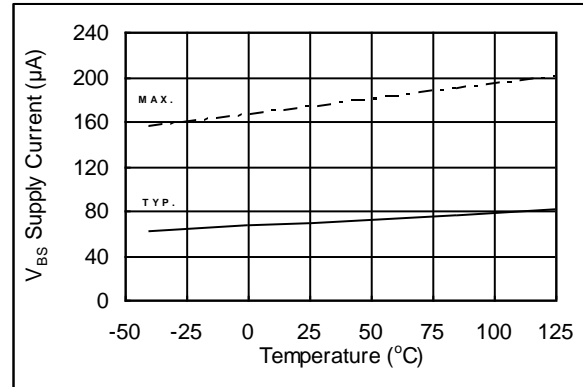

Figure 8A. VBS Supply Current vs. Temperature

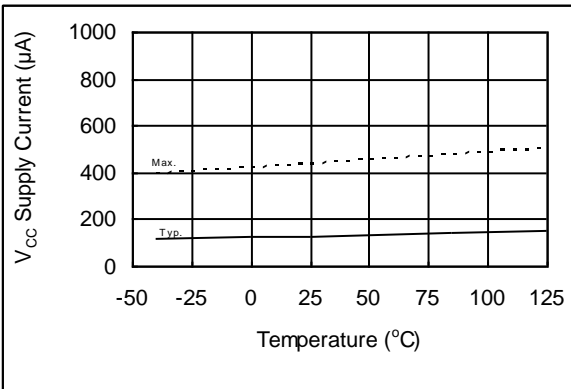

Figure 9A. Vcc Supply Current vs. Temperature

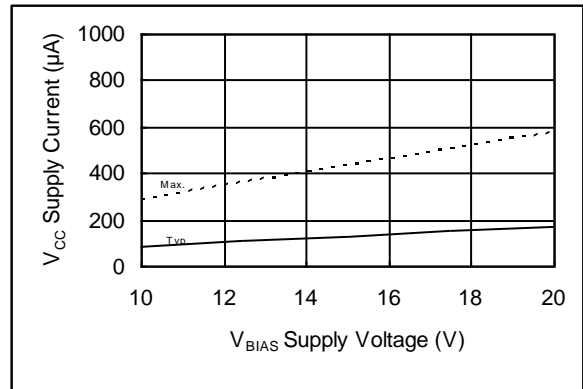

Figure 9B. Vcc Supply Current vs. Supply Voltage

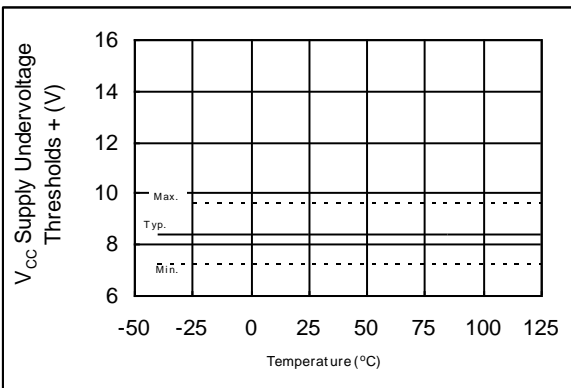

Figure 10A. Vcc Supply Undervoltage Threshold (+) vs. Temperature

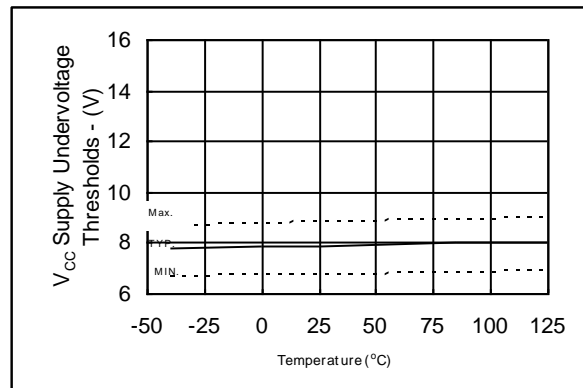

Figure 10B. Vcc Supply Undervoltage Threshold (-) vs. Temperature

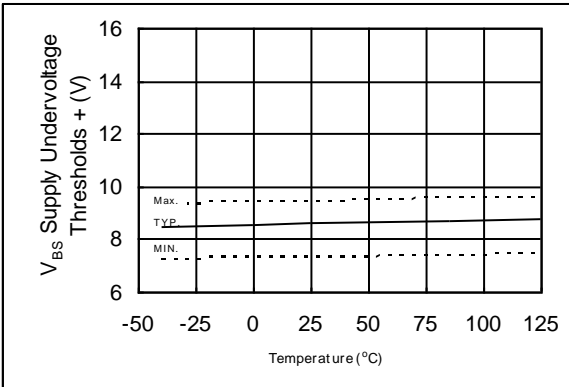

Figure 11A. VBS Supply Undervoltage Threshold (+) vs. Temperature

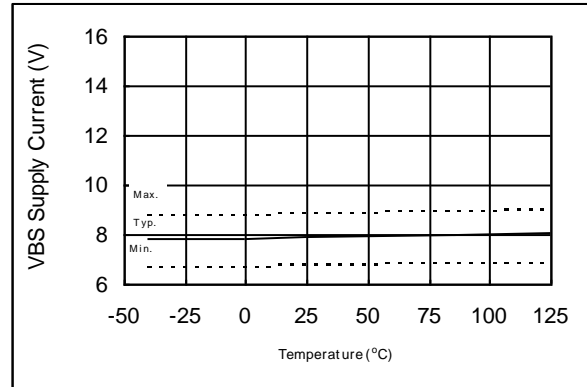

Figure 11B. VBS Supply Undervoltage Threshold (-) vs. Temperature

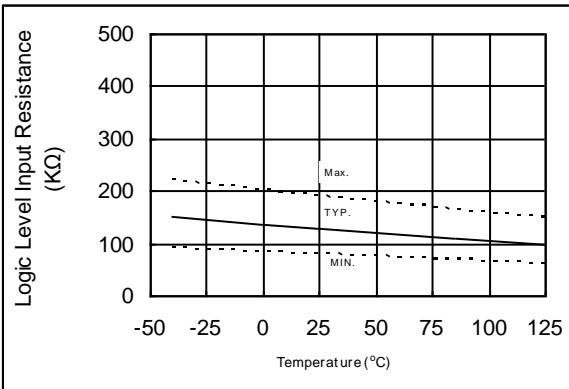

Figure 12. Logic Level Input Resistance vs. Temperature

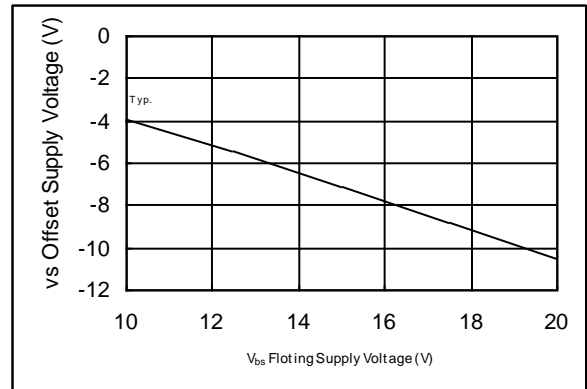
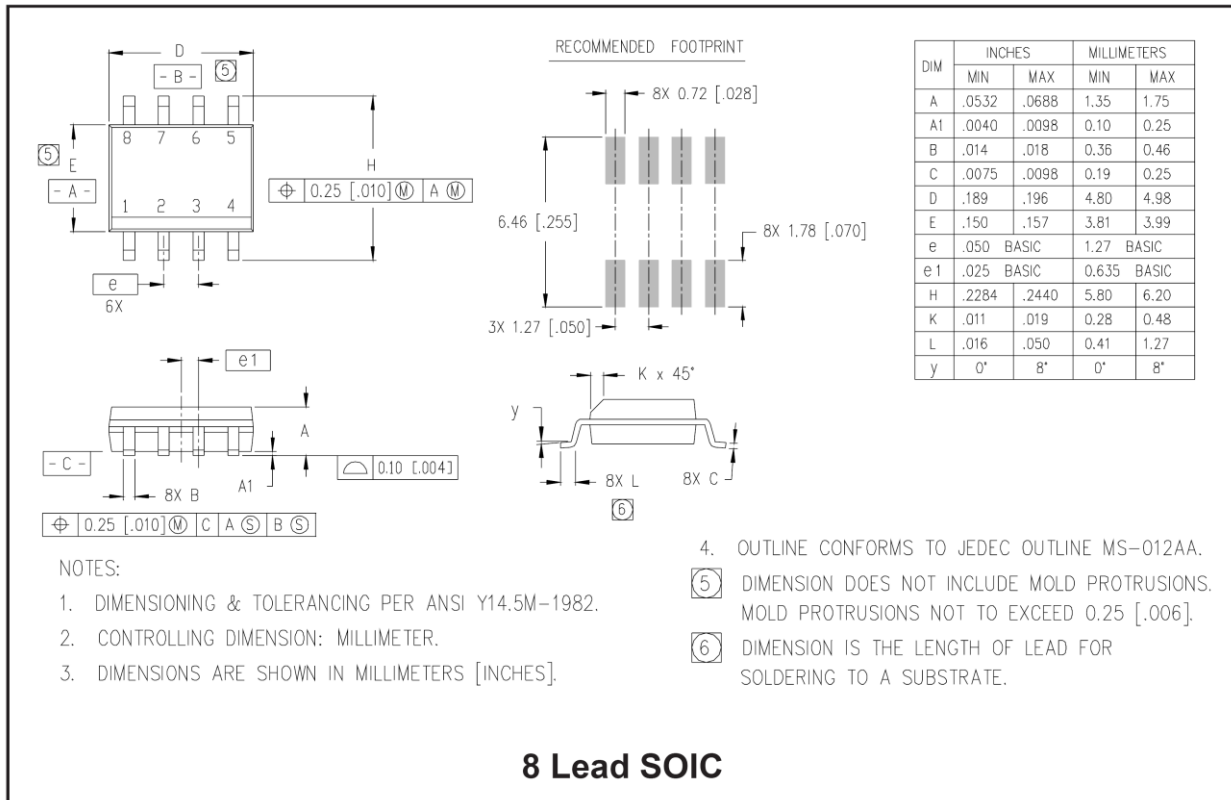
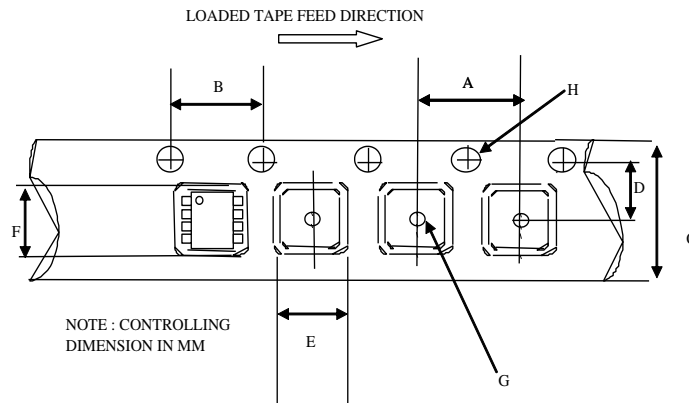

Figure 13. Maximum VS Negative Offset vs. Supply Voltage

Package Details



Tape and Reel Details



CARRIER TAPE DIMENSION FOR 8SOICN

Code	Metric		Imperial	
	Min	Max	Min	Max
A	7.90	8.10	0.311	0.318
B	3.90	4.10	0.153	0.161
C	11.70	12.30	0.46	0.484
D	5.45	5.55	0.214	0.218
E	6.30	6.50	0.248	0.255
F	5.10	5.30	0.200	0.208
G	1.50	n/a	0.059	n/a
H	1.50	1.60	0.059	0.062

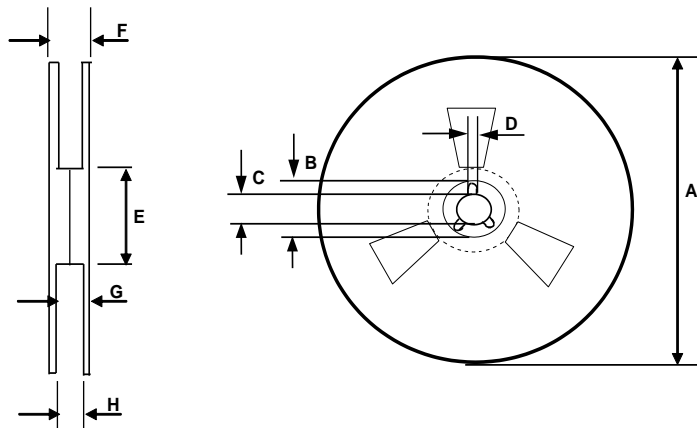

REEL DIMENSIONS FOR 8SOICN

Code	Metric		Imperial	
	Min	Max	Min	Max
A	329.60	330.25	12.976	13.001
B	20.95	21.45	0.824	0.844
C	12.80	13.20	0.503	0.519
D	1.95	2.45	0.767	0.096
E	98.00	102.00	3.858	4.015
F	n/a	18.40	n/a	0.724
G	14.50	17.10	0.570	0.673
H	12.40	14.40	0.488	0.566

Part Marking Information

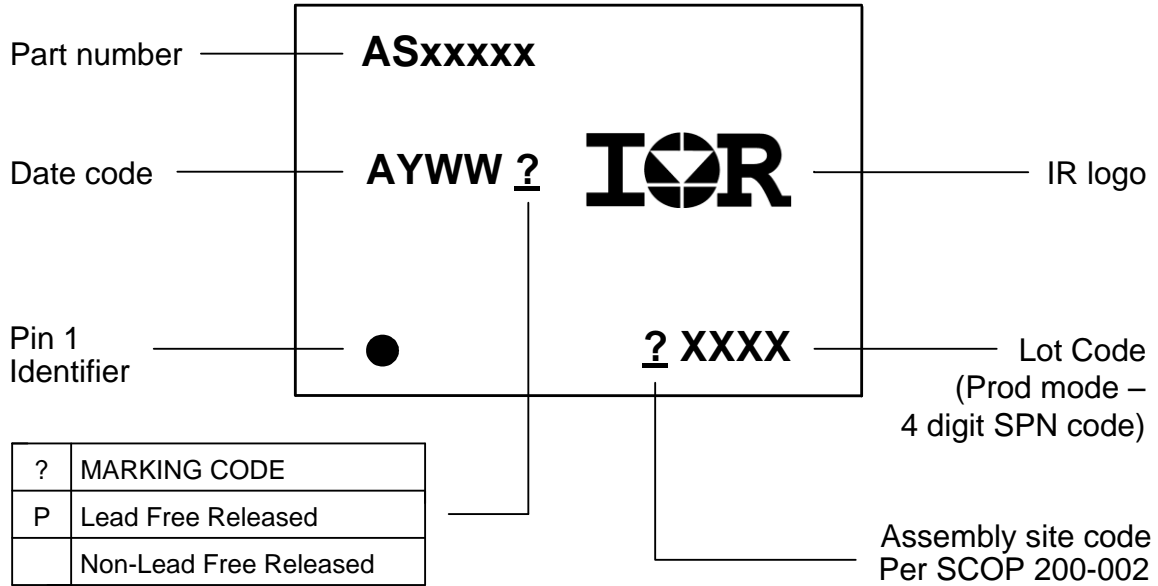

Published by
Infineon Technologies AG
81726 München, Germany
© Infineon Technologies AG 2015
All Rights Reserved.

IMPORTANT NOTICE

The information given in this document shall in no event be regarded as a guarantee of conditions or characteristics (“Beschaffenheitsgarantie”). With respect to any examples, hints or any typical values stated herein and/or any information regarding the application of the product, Infineon Technologies hereby disclaims any and all warranties and liabilities of any kind, including without limitation warranties of non-infringement of intellectual property rights of any third party.

In addition, any information given in this document is subject to customer’s compliance with its obligations stated in this document and any applicable legal requirements, norms and standards concerning customer’s products and any use of the product of Infineon Technologies in customer’s applications.

The data contained in this document is exclusively intended for technically trained staff. It is the responsibility of customer’s technical departments to evaluate the suitability of the product for the intended application and the completeness of the product information given in this document with respect to such application.

For further information on the product, technology, delivery terms and conditions and prices please contact your nearest Infineon Technologies office (www.infineon.com).

WARNINGS

Due to technical requirements products may contain dangerous substances. For information on the types in question please contact your nearest Infineon Technologies office.

Except as otherwise explicitly approved by Infineon Technologies in a written document signed by authorized representatives of Infineon Technologies, Infineon Technologies’ products may not be used in any applications where a failure of the product or any consequences of the use thereof can reasonably be expected to result in personal injury.